

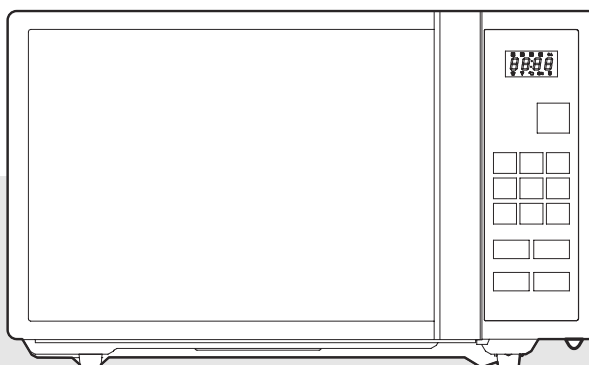

# MICROWAVE CONVECTION/GRILL OVEN

KOC-9Q1T

OWNER'S  
MANUAL



Before operating this oven, please read  
this manual completely.

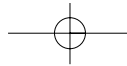

## PRECAUTIONS TO AVOID POSSIBLE EXPOSURE TO EXCESSIVE MICROWAVE ENERGY

- (a) **Do not attempt to operate this oven with the door open** since open-door operation can result in harmful exposure to microwave energy. It is important not to defeat or tamper with the safety interlocks.
- (b) **Do not place any object** between the oven front face and the door or allow soil or cleaner residue to accumulate on sealing surfaces.
- (c) **WARNING** : If the door or door seals are damaged, the oven must not be operated until it has been repaired by a competent person: (1) door (bent), (2) hinges and latches (broken or loosened), (3) door seals and sealing surfaces.
- (d) **WARNING** : It is hazardous for anyone other than a competent person to carry out any service or repair operation which involves the removal of a cover which gives protection against exposure to microwave energy.
- (e) **WARNING** : Liquids and other foods must not be heated in sealed containers since they are liable to explode.
- (f) **WARNING** : Only allow children to use the oven without supervision when adequate instructions have been given so that the child is able to use the oven in a safe way and understands the hazards of improper use.
- (g) **WARNING** : When the appliance is operated in the combination mode, children should only use the oven under adult supervision due to the temperatures generated.

## TABLE OF CONTENTS

• INSTALLATION AND EARTHING INSTRUCTIONS.....	2	• GENERAL GUIDE LINES.....	21
• IMPORTANT SAFETY INSTRUCTIONS.....	3	• KEEP THE OVEN CLEAN.....	22
• WHICH UTENSILS CAN BE USED IN THE OVEN?.....	5	• BEFORE CALLING FOR SERVICE.....	23
• COOKING INSTRUCTIONS.....	6	• QUESTIONS AND ANSWERS.....	24
• CONTROL PANEL.....	7	• SPECIFICATIONS.....	25
• ACCESSORIES.....	8	• PRINCIPLE OF MICROWAVE.....	25
• BEFORE OPERATION.....	9	• DISPOSAL OF USED ELECTRICAL & ELECTRONIC EQUIPMENT.....	25
SETTING THE CLOCK.....	9	• COOKING TECHNIQUES.....	26
CHILD LOCK AND POWER SAVE MODE.....	10	• DEFROSTING GUIDE.....	27
• OPERATION.....	11	• COOKING & REHEATING CHART.....	28
MICROWAVE COOKING.....	11	• VEGETABLE CHART.....	29
GRILL COOKING.....	12	• RECIPES.....	30
CONVECTION COOKING (WITH PRE-HEAT).....	13		
CONVECTION COOKING (TRADITIONAL COOKING).....	14		
COMBINATION COOKING.....	15		
(1) WEIGHT DEFROST MODE.....	16		
(2) TIME DEFROST MODE.....	16		
AUTO COOK.....	17		
SPEEDY COOK.....	18		
DISH WARMER (FOR PREMIER OPTION MODEL ONLY).....	18		
WARM.....	19		
STEAM CLEANING.....	19		
REMINDER MODE (FUNCTION TO REMIND COOKING COMPLETE).....	19		
TO STOP THE OVEN WHILE THE OVEN IS OPERATING.....	20		
ABNORMAL MESSAGE.....	20		
ARCING.....	20		

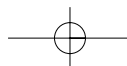

# INSTALLATION AND EARTHING INSTRUCTIONS

## How to examine your microwave oven after unpacking.

Unpack oven, remove all packing material, and examine the oven for any damage such as dents, broken door, latches or cracks in the door. Do not remove the film from inside the door. Notify dealer immediately if the oven is damaged. Do not install if the oven is damaged.

## Where to place your microwave oven.

1. Place the oven on a flat and stable surface.
2. The microwave oven shall not be placed in a cabinet unless it is a purpose built cabinet model.
3. The surface of the oven is protected by a plastic film which should be removed before using.
4. Leave space behind and sides and upper of the oven. All air vents should be kept clear.  
If all vents are covered during operation, the oven may overheat and, eventually, lead to oven failure.
5. Keep away from radio and TV sets. If the oven is located close to a TV, radio interference may result.
6. Keep away from heating appliances and water taps. Keep the oven away from hot air, steam or splashes when choosing a place to position it, or the insulation might be adversely affected and breakdowns occur.
7. The minimum height of free space necessary above the top surface of the oven is 170mm minimum.

## Prior to use (If your oven has a grill element)

In order to protect your oven during transportation and storage, the grill element is covered with a protective coating. To remove this coating the grill element must be heated for 10 minutes. This procedure will produce some bad odours as the protective coating on the element disappears.

To remove the coating, use the following procedures:

1. Place an ovenproof or microwave safe bowl, containing 200cc of water or more, in the oven.
2. Press the convection pad.
3. Set the time to 10 minutes.
4. Press the start pad.
5. When the 10 minutes has elapsed, an acoustic signal sounds.

## Note:

The protective coating has now been removed and the oven is ready to use. Please be aware that your oven is now very hot.

6. Open the oven door and remove the bowl of water (use oven gloves when removing the bowl).

## CHILD LOCK

To prevent a child from operating the oven, install the childlock key.

1. Touch Stop/Clear pad for 3 seconds.  
Indicator lock is indicated and all pads do not operate.
2. Touch Stop/Clear pad for 3 seconds once again, then childlock is canceled.

- **WARNING:** Only allow children to use the oven without supervision when adequate instructions have been given so that the child is able to use the oven in a safe way and understands the hazards of improper use.

## Electrical Connection

**WARNING-THIS APPLIANCE MUST BE EARTHED.**

**REFER TO THE RATING PLATE FOR VOLTAGE AND CHECK THAT THE APPLIANCE VOLTAGE CORRESPONDS WITH THE SUPPLY VOLTAGE IN YOUR HOME.**

The flexible mains lead must be correctly re-connected, as below, to a three pin plug of not less than 13 AMP capacity. You must use a 3 pin plug which should be marked with the number BS 1363 and it should be fitted with 13 AMP fuse marked with the

number BS 1362.

We recommend the use of good quality plugs and wall sockets that can be switched off when the machine is not in use.

**IMPORTANT-**The wires in the mains lead fitted to this appliance are coloured in accordance with the following code

GREEN AND YELLOW-EARTH  
BLUE-NEUTRAL  
BROWN-LIVE

As the colour of the wires in the mains lead of this appliance may not correspond with the coloured markings identifying the terminals in your plug, proceed as follows:

## Power supply

- Check your local power source. This oven requires a current of approximately 12amperes, 230V 50Hz.
- Power supply cord is about 1.0 meters long.
- The voltage used must be the same as specified on this oven. Using a higher voltage may result in a fire or other accident causing oven damage. Using low voltage will cause slow cooking. We are not responsible for damage resulting from use of this oven with a voltage of ampere fuse other than those specified.
- If the supply cord is damaged, it must be replaced by the manufacturer or its service agent or a similarly qualified person in order to avoid a hazard.

The wire which is coloured GREEN AND YELLOW must be connected to the terminal in the plug which is marked with the letter "E" or the earth symbol  $\perp$  or coloured GREEN AND YELLOW, or GREEN.

The wire which is coloured BLUE must be connected to the terminal which is marked with the letter "N" or coloured BLACK, or BLUE.

The wire which is coloured BROWN must be connected to the terminal which is marked with the letter "L" or coloured RED, or BROWN.

If the terminals in the plug are unmarked or you are in any doubt as to the correct connections, consult a qualified electrician.

If you do not make the proper electrical connections you will damage your microwave oven and possibly injure yourself. Neither the manufacturer nor the supplier are liable if this happens.

## MOULDED PLUGS

Should it be necessary to remove a moulded on plug from the mains cable, it should be cut off and replaced with a suitable replacement.

The moulded plug cannot be used for any other appliance, therefore remove the fuse and dispose immediately and safely to prevent anyone, especially children from plugging it in to a wall socket, which will create a safety hazard.

Should the mains lead ever require replacement, it is essential that this operation be carried out by a qualified electrician and should only be replaced with a flexible cord obtained from the manufacturer.

## Applicable only if moulded plug is fitted.

After replacement of a fuse in the plug, the fuse cover must be refitted. If the fuse cover is lost, a replacement cover must be obtained. The colour of the correct replacement fuse cover is that of the coloured insert in the base of the plug or the colour that is embossed in words in the base of the plug recess or elsewhere on the plug. Always state this colour when ordering a replacement fuse cover.

Only 13 amp replacement fuses which are ASTA approved to BS 1362 should be fitted

# IMPORTANT SAFETY INSTRUCTIONS

## READ CAREFULLY AND KEEP FOR FUTURE REFERENCE

When using electrical appliances, basic safety precautions should be followed, including the following:

**WARNING-**To reduce the risk of burns, electric shock, fire, injury to persons or exposure to excessive microwave energy:

1. Read all instructions before using the appliance.
2. Read and follow the specific "PRECAUTIONS TO AVOID POSSIBLE EXPOSURE TO EXCESSIVE MICROWAVE ENERGY" found on page 1.
3. This appliance must be grounded. Connect only to a properly grounded outlet.
4. Install or locate this appliance only in accordance with the provided installation instructions.
5. Some products such as whole eggs and sealed containers - for example, closed glass jars-are liable to explode and should not be heated in this oven.
6. Use this appliance only for its intended use as described in this manual. Do not use corrosive chemicals or vapors in this appliance. This type of oven is specifically designed to heat, cook, or dry food. It is not designed for industrial or laboratory use.
7. As with any appliance, close supervision is necessary when used by children.
8. Do not operate this appliance if it has a damaged cord or plug, if it is not working properly, or if it has been damaged or dropped.
9. This appliance should be serviced only by qualified service personnel.  
Contact your nearest authorized service facility for examination, repair or adjustment.
10. Do not cover or block any openings on the appliance.
11. Do not store this appliance outdoors. Do not use this product near water — for example, near a kitchen sink, in a wet basement, or near a swimming pool, or similar locations.
12. Do not immerse the cord or plug in water.
13. Keep the cord away from heated surfaces.
14. Do not let cord hang over edge of table or counter.
15. Either:
  - a) When cleaning surfaces of door and oven that comes together on closing the door, use only mild, non-abrasive soaps or detergents applied with a sponge or soft cloth , or
  - b) When separate cleaning instructions are provided, See door surface cleaning instructions on.
16. To reduce the risk of fire in the oven cavity:
  - a) Do not overcook food. Carefully attend the appliance when paper, plastic, or other com-bustible materials are placed inside the oven to facilitate cooking.
  - b) Remove wire twist-ties from paper or plastic bags before placing bag in the oven.
  - c) If materials inside the oven ignite, keep oven door closed, turn oven off, and disconnect the power cord, or shut off power at the fuse or circuit breaker panel.
  - d) Do not use the cavity for storage purposes. Do not leave paper products, cooking utensils, or food in the cavity when not in use.
17. Do not use this microwave oven to heat corrosive chemicals (for example, sulfides and chlorides). Vapours from such corrosive chemicals may interact with the contact and springs of the safety interlock switches thereby rendering them inoperable.
18. Keep the waveguide cover clean at all times. Wipe the oven interior with a soft damp cloth after each use. If you leave grease or fat anywhere in the cavity it may overheat, smoke or even catch fire when next using the oven.
19. Never heat oil or fat for deep frying as you cannot control the temperature and doing so may lead to overheating and fire.
20. Liquids, such as water, coffee, or tea are able to be overheated beyond the boiling point without appearing to be boiling due to surface tension of the liquid. Visible bubbling or boiling when the container is removed from the microwave oven is not always present. **THIS COULD RESULT IN VERY HOT LIQUIDS SUDDENLY BOILING OVER WHEN A SPOON OR OTHER UTENSIL IS INSERTED INTO THE LIQUID.** To reduce the risk of injury to persons:
  - ① Do not overheat the liquid.
  - ② Stir the liquid both before and halfway through heating it
  - ③ Do not use straight-sided containers with narrow necks.
  - ④ After heating, allow the container to stand in the microwave oven for a short time before removing the container.
  - ⑤ Use extreme care when inserting a spoon or other utensil into the container.
21. The contents of feeding bottles and baby jars must be stirred or shaken and check the temperature before consumption to avoid burns.
22. The appliance must be positioned so that the plug is accessible.
23. This appliance is not intended for use by a person (including children) with reduced physical, sensory or mental capabilities, or lack of experience and knowledge, unless they have been given supervision or instruction concerning use of the appliance by a person responsible for their safety.
24. Children should be supervised to ensure that they do not play with the appliance.
25. Due to extremely high temperatures, do not touch the surface of door and the Top heater of oven during and after running the heater related cooking mode.

**SAVE THESE INSTRUCTIONS**

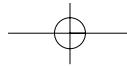

## General Use

Listed below are, as with all appliances, certain rules to follow and safeguards to assure top performance from this oven:

1. Do not use the oven for any reason other than food preparation, such as for drying clothes, paper, or any other nonfood items or for sterilizing purposes. They may catch on fire.
2. Do not use the oven when empty, this could damage the oven.
3. Do not use the oven cavity for any type of storage, such as papers, cookbook, cookware, etc.
4. Do not operate the oven without the turntable tray in place. Be sure it is properly sitting on the rotating base.
5. Be cautious when removing the turntable tray after cooking meats that may have caused an accumulation of grease in the tray.
6. Unlike microwave-only ovens, this oven may become hot on the cabinet and oven door. Always use hot pads or oven mitts when placing or removing food and/or accessories from the oven. Be cautious about touching parts other than the control panel during or immediately following grill or combination cooking.
7. If the oven is hot from combination cooking, do not use plastic or Styrofoam cookware for microwave cooking. They may melt.
8. Do not use recycled paper products for cooking. They may contain impurities which could cause sparks and/or fires when used during cooking.
9. Do not continue to cook with metal utensils if sparking appears. See "Accessories" section on page 8 for proper use of cookware.
10. Do not leave the oven unattended during short cooking times. Overcooking and fire may result.
11. Do not cook any food surrounded by a membrane, such as egg yolks, potatoes, chicken livers, etc., without first piercing them several times with a fork.
12. Do not pop popcorn unless popped in a microwave approved popcorn popper or unless it's commercially packaged and recommended especially for microwave ovens. Microwave popped corn produces a lower yield than conventional popping; there will be a number of unpopped kernels. Do not use oil unless specified by the manufacturer.
13. Do not attempt to operate this appliance with the door open.
14. Do not attempt to remove covers, panels, etc.
15. Keep an eye on the oven from time to time when food is heated or cooked in disposable containers of plastic, paper or other combustible materials.
16. If smoke is observed, switch off or unplug the appliance and keep the door closed in order to stifle any flames.
17. Microwave heating of beverages can result in delayed eruptive boiling, therefore care must be taken when handling the container.
18. Make sure you remove caps or lids prior to cooking when you cook food sealed in bottles.
19. Do not put foreign material between the oven surface and door. It could result in excessive leakage of microwave energy.
20. Do not pop popcorn longer than the manufacturer's directions. (popping time is generally below 3 minutes). Longer cooking does not yield more popped corn, it can cause scorplings and fire. Also, the cooking tray can become too hot to handle or may break.
21. When heating food in plastic or paper containers, keep an eye on the oven due to the possibility of ignition.
22. Always test the temperature of food or drink which has been heated in a microwave oven before you give it to somebody, especially to children or elderly people. This is important because things which have been heated in a microwave oven carry on getting hotter even though the microwave oven cooking has stopped.
23. Eggs in their shell and whole hard-boiled eggs should not be heated in microwave ovens since they may explode, even after microwave heating has ended;
24. Keep the waveguide cover clean at all times. Wipe the oven interior with a soft damp cloth after each use. If you leave grease or fat anywhere in the cavity it may overheat, smoke or even catch fire when next using the oven.
25. Never heat oil or fat for deep frying as you cannot control the temperature and doing so may lead to overheating and fire.
26. During use the appliance becomes hot. Care should be taken to avoid touching heating elements inside the oven.
27. Do not use a steam cleaner in the oven.

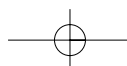

## TO AVOID EXPLOSION AND SUDDEN BOILING

### WARNING

Liquids, such as water, coffee, or tea are able to be overheated beyond the boiling point without appearing to be boiling due to surface tension of the liquid. Visible bubbling or boiling when the container is removed from the microwave oven is not always present. This could result in very hot liquids suddenly boiling over when a spoon or other utensil is inserted into the liquid.

To reduce the risk of injury to persons:

- a) Do not overheat the liquid.
- b) Stir the liquid both before and halfway through heating it
- c) Do not use straight-sided containers with narrow necks.
- d) After heating, allow the container to stand in the microwave oven for a short time before removing the container.
- e) Use extreme care when inserting a spoon or other utensil into the container.

### 1. Eggs

Never cook eggs in their shells. Steam will build up inside the shell during cooking and the egg will explode.

If you want to cook or reheat eggs which have not been broken up by scrambling or mixing, you must always pierce the yolks or these will also explode. You should slice shelled hard boiled eggs before you reheat them in your microwave oven.

### 2. Piercing

Always pierce food which has a skin or membrane, for example, potatoes, tomatoes, apples, sausages etc. If you don't pierce them, steam will build up inside and they may explode.

### 3. Lids

Always remove the lids of jars and containers and take away food containers, before you cook using your microwave oven. If you don't, then steam and pressure might build up inside and cause an explosion even after the microwave cooking has stopped.

## WHICH UTENSILS CAN BE USED IN THE OVEN?

Only use utensils that are suitable for use in microwave ovens.

Before use, the user should check that utensils are suitable for use in microwave ovens.

Material	Grill & Convection cooking	Microwave cooking	Combined cooking
Glass (general)	No	Yes (1)	No
Glass (heat resistant)	Yes	Yes	Yes
Glass-ceramic and ceramic (heat resistant)	Yes	Yes (1)	Yes (1)
Earthenware	Yes	Yes	Yes
China (heat resistant)	Yes	Yes	Yes
Plastic (general)	No	Yes (2)	No
Plastic (heat resistant)	Yes (2)	Yes (2)	Yes (2)
Aluminium foil	Yes	Yes (3)	Yes
Metal baking tins	Yes (4)	No	Yes (4)
Metal (pots, pans, etc)	Yes	No	No
Paper	No	Yes	No

1. Without metal parts or metal trims.
2. Some plastics are heat-proof only to certain temperatures. Check carefully!
3. It is possible to use aluminium foil to shield delicate areas of food (this prevents over-cooking).
4. Metal tins can be used in the combination methods, however if these are very deep, they will greatly reduce the efficiency, as metal shields the microwave energy from the food.

Utensils made of china and ceramic are excellent to use in your microwave oven. Most types of glass are also very good.

Lead crystal glass can crack and should therefore, not be used. Plastics and paper can also be used, provided they can withstand the temperature of the heated food. For cooking only use plastics, which will withstand a temperature of over 120°C, e.g. polypropene and polyamide. Some plastic materials, e.g. melamine, will be heated by the microwave, and be damaged. To find out if a certain container is suitable, the following simple test can be made:

Place the empty container and a glass of water inside the microwave oven. The water is needed because the oven must not be operated empty or with empty containers only. Let the oven work on full power for one minute. A suitable container will only be lukewarm.

Metal containers, e.g. saucepans or frying pans should not be used in microwave ovens. Nor should plates or vessels with decorations be used since metal e.g. gold, might be part of the decoration and such decorations will be damaged.

Small pieces of aluminium foil can be used, but only to shield the areas that would over-cook (e.g. for covering chicken wings, leg tips and fish tails) but the foil must not touch the side of the oven as damage may occur.



### Microwave function only

Utensils and cooking containers used in a microwave oven should be of a material that does not act as a barrier to microwave energy. Generally this means that you should cook in either (paper), plastic, glass or ceramic. Metal pans reflect microwave energy and inhibit cooking, and should not be used. In addition to material, the shape of the container should also be considered. Round oval shapes give the most even cooking. Square or rectangular containers may over-cook foods in the corners because more energy is absorbed there. Shallow containers give more even cooking results.

### Caution:

- There are a number of accessories available on the market. Before you buy, make sure they are suitable for microwave use.
- When you put food in the microwave oven, make sure that food, food supports or covering do not come in direct contact with any of the internal walls or the ceiling of the cavity since discolouration may take place.

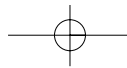

# COOKING INSTRUCTIONS

Only use utensils that are suitable for use in microwave ovens.

To cook food in the microwave oven, the microwaves must be able to penetrate the food, without being reflected or absorbed by the dish used.

Care must therefore be taken choosing the utensil. If the utensil is marked microwave-safe, you do not need to worry.

The following table lists various of utensil and indicates whether and how they should be used in a microwave oven.

Utensil	Safe	Comments
<b>Aluminium foil</b>	▲	Can be used in small quantities to protect areas against overcooking. Arcing can occur if the foil is too close to the oven wall or if too much foil is used.
<b>Crust plate</b>	●	Do not preheat for more than 8minutes.
<b>China and earthenware</b>	●	Porcelain, pottery, glazed earthenware and bone china are usually suitable, unless deco-rated with a metal trim.
<b>Disposable polyester cardboard dishes</b>	●	Some frozen foods are packaged in these dishes.
<b>Fast-food packaging</b> • Polystyrene cups containers  • Paper bags or newspaper • Recycled paper or metal trims	●  X X	Can be used to warm food. Overheating may cause the polystyrene to melt. May catch fire. May cause arcing.
<b>Glassware</b> • Oven-to-table ware • Fine glassware  • Glass jars	● ● ●	Can be used, unless decorated with a metal trim. Can be used to warm foods or liquids. Delicate glass may break or crack if heated suddenly. Must remove the lid. Suitable for warming only.
<b>Metal</b> • Dishes • Freezer bag twist ties	X X	May cause arcing or fire.
<b>Paper</b> • Plates, cups, napkins and Kitchen paper • Recycled paper	● X	For short cooking times and warming. Also to absorb excess moisture. May cause arcing.
<b>Plastic</b> • Containers  • Cling film  • Freezer bags	● ● ▲	Particularly if heat-resistant thermoplastic. Some other plastics may warp or discolour at high temperatures. Do not use Melamine plastic. Can be used to retain moisture. Should not touch the food. Take care when removing the film as hot steam will escape. Only if boilable or oven-proof. Should not be airtight. Prick with a fork, if necessary.
<b>Wax or grease-proof paper</b>	●	Can be used to retain moisture and prevent spattering.

● : Recommended use

▲ : Limited Use

X : Not Recommended

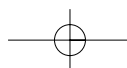

# CONTROL PANEL

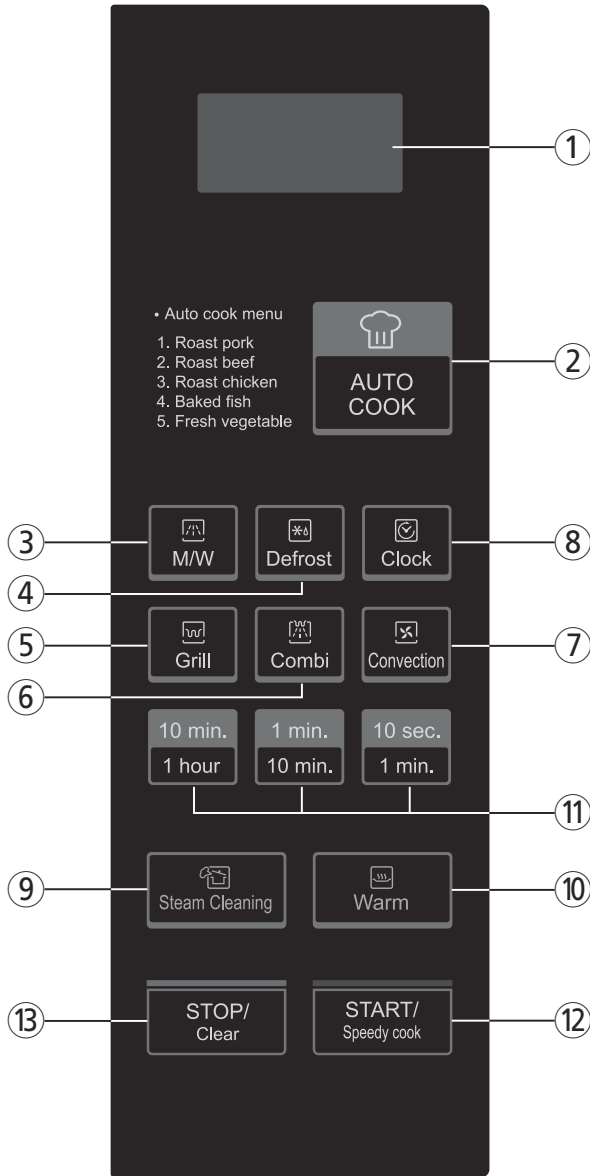

- ① **Display** : Cooking time, power level, program indicators and present time are displayed.  
 MW (M/W): When blinking, the oven is operating in MICROWAVE COOK mode.  
 Grill (Grill): When blinking, the oven is operating in GRILL mode.  
 Combi (Combi): When blinking, the oven is operating in COMBI mode.  
 Convection (Convection): When blinking, the oven is operating in CONVECTION mode.  
 Defrost (Defrost): When blinking, the oven is operating in DEFROST mode.  
 Auto-cook (Auto-cook): When blinking, the oven is operating in AUTO COOK mode.  
 Warm (Warm): When blinking, the oven is operating in WARM mode.  
 Steam Cleaning (Steam Cleaning): When blinking, the oven is operating in STEAM CLEANING mode.  
 gram (g): When blinking, the oven is operating in weight input mode.
- ② **Auto cook** : Used to cook or reheat.
- ③ **MW** : Used to set power level of the microwave.
- ④ **Defrost** : Used to defrost foods.
- ⑤ **Grill** : Used to select grill mode.
- ⑥ **Combi** : Used to select combi mode.
- ⑦ **Convection** : Used to select convection mode and selected temp.
- ⑧ **Clock** : Used to set clock.
- ⑨ **STEAM CLEANING** : Used to clean the inside of the oven
- ⑩ **Warm** : Used to keep the food warm.
- ⑪ **Time set pad** : Used to set time, weight and quantity.
- ⑫ **START/SPEEDY COOK** : Used to start a program or a speedy start(each press adds 30 seconds of microwave cooking time).
- ⑬ **STOP/CLEAR** : Used to stop the oven operation or to delete the cooking data.



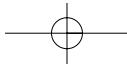

# ACCESSORIES

This oven comes equipped with several accessories. They can be used in various ways to facilitate cooking.

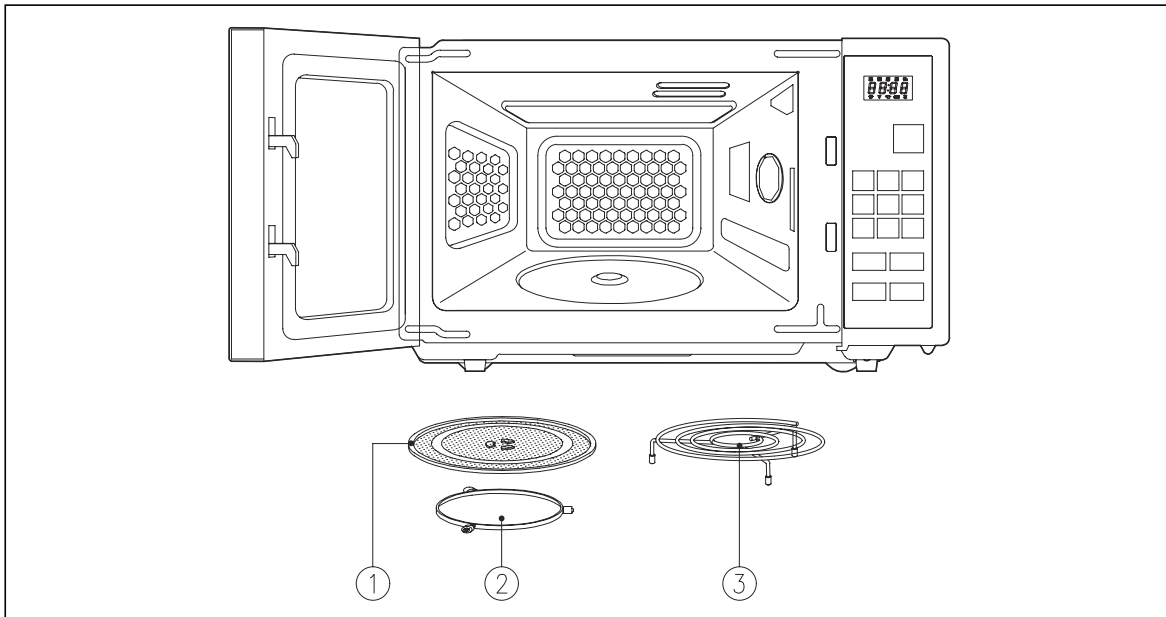

① **Glass Turntable** - Center the tray on the roller guide when using the microwave features. Place food or microwave-safe cookware directly on the glass turntable.

**NOTE** : Glass Turntable is attached on the left cushion.

② **Roller Guide** - The roller guide must be in place when using the oven.  
**IMPORTANT** : The roller guide must be placed at the center of the oven cavity.

③ **Metal Rack** - Center the rack on the glass tray when using the grill cooking, convection cooking, and auto cooking menus.

## ■ HOW TO USE THE ACCESSORIES OF COOKING

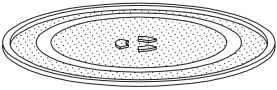
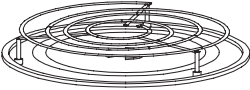
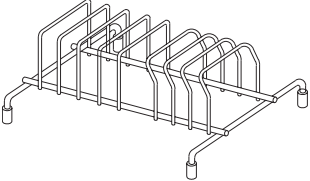
<p>■ <b>Glass Turntable</b></p>  <p>• All Cooking modes.</p>	<p>■ <b>Metal rack</b></p>  <p>• Grill cooking                      • Convection cooking                      • Combination cooking                      • Auto cooking menu 1~4.</p>	<p>■ <b>Dish-Warm rack (Premium option model only)</b></p>  <p>• Dish warming</p>
---	--	--

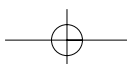

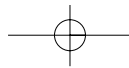

# BEFORE OPERATION

## SETTING THE CLOCK

When your oven is plugged in, the display will show “:0” and a tone will sound. If the AC power goes off and comes back on, the display will show “:0”.

Your oven has a multiple(12hr/24hr) clock system. To set the clock, follow the procedure below.

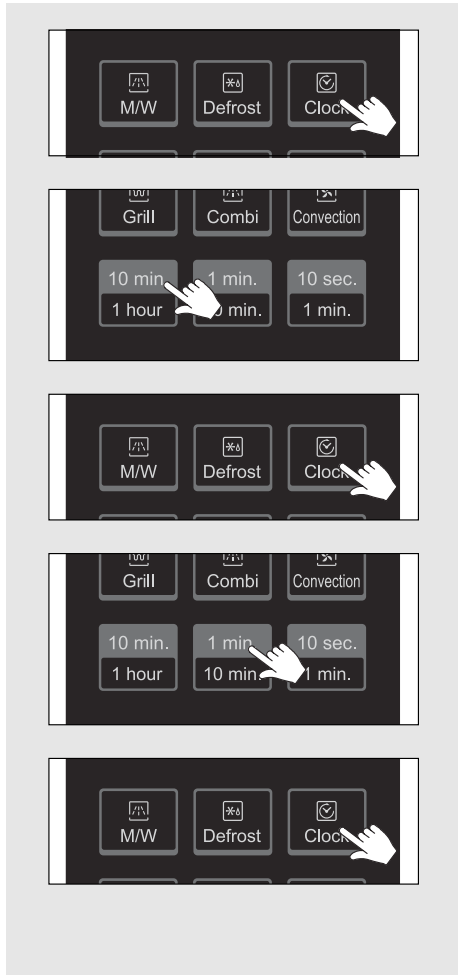

### Example : To set 5:30 in a 24hr clock system.

1. Touch **Clock** pad once. (example : to set “5:30”)  
The display will show “ 12H ”. This is a 12 hour clock system.
2. Touch **Clock** pad once more, the display shows “24H”.  
This is a 24hour clock system. If you want 12hour clock system, omit this step.
3. Touch the **time set** pad to set the hour number “5”.  
The hour digit starts blinking, the colon will light.
4. Touch **Clock** pad. “5:00” shows in display.  
The minute digit starts blinking, the colon and hour number will light.
5. Touch the **time set** pad until “5:30” shows in the display window.
6. Touch **Clock** pad. The colon starts blinking.  
If you selected the 12hour clock system, this digital clock allows you to set the time from **1:00** to **12:59**.  
If you selected the 24hour clock system, this digital clock allows you to set the time from **0:00** to **23:59**.

**Note** : You can check the current time while cooking is in progress by pressing the **Clock** pad.

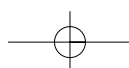

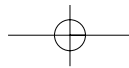

## CHILD LOCK AND POWER SAVE MODE

**Child lock** : The Child Lock function helps to prevent accidents from children operating the oven without being monitored by the parents.  
**Power save mode** : This function is used for saving energy.

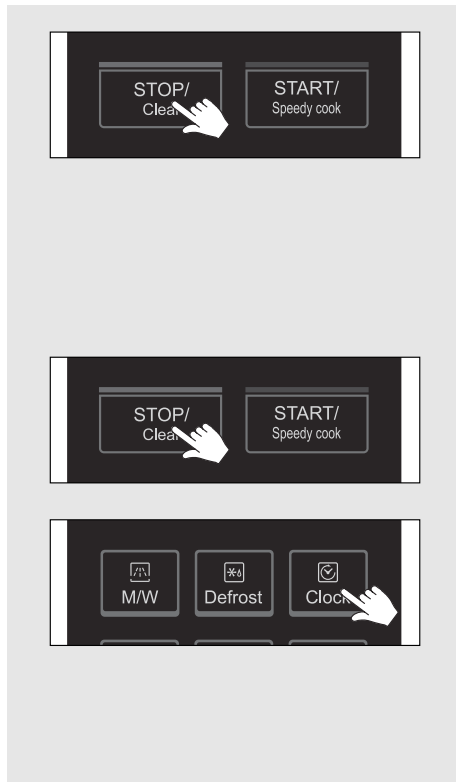

### To set child lock

1. Touch the **STOP/CLEAR** pad.  
 “: 0” or clock appears in the display.
2. Touch and hold the **STOP/CLEAR** pad for 3 seconds.  
 A beep sounds and the display shows “LOC ” for 3 seconds.  
 Now the oven cannot be operated.
3. To cancel child lock simply repeat procedure 2.  
 The oven will beep.  
 The oven is again available for normal use.

### To set power save mode

1. Touch the **STOP/CLEAR** pad.  
 “: 0” or clock appears in the display.
2. Touch and then hold the **Clock** pad for 3 seconds.  
 The display will turn off and a beep sounds.  
 To operate the oven in power save mode, touch any key or turn the time set pad.  
 Then “:0” or clock will be shown and the operation of all function key will be the same as in the normal mode.  
 But if there is no operation within 10 seconds in clear mode or while manipulating the key, all the contents of display will disappear.
3. To cancel the power save mode, simply repeat the setting procedure.  
 The power save mode will be canceled and a beep sounds.  
 The oven is again available for normal use.

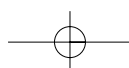

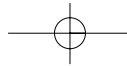

# OPERATION

**Tips :** Please read this OPERATION section for the proper safety information and the operating instructions before use of the oven. Prior to setting the controls, place one cup of water in the oven, in a heat-proof glass measuring cup, for testing purposes. The oven could be damaged if operate the oven in microwave mode without anything in the cavity.

**Note :** When the cooking time elapsed the oven beeps three times and "End" appears on the display. The glass turntable stops and the oven-light turns off. The oven will continue to beep every one-minute until either the STOP/CLEAR pad is touched or the door is opened. Opening the door while cook is in progress will cause the oven to stop and any displayed countdown will pause. If the START/SPEEDY COOK pad is touched, the countdown will resume. If the STOP/CLEAR pad is touched, the cook will cancel. The oven can display the set cooking time in 10 second steps (up to 90 seconds cooking time), in 1 minute steps (up to 9 minutes cooking time), and in 10 minutes steps (up to 50 minutes cooking time).  
 When the door is opened after cooking, the cooling fan may start to operate for 5 minutes to cool down the inside of oven. (Display shows "cool" and ":0 or clock")  
 Note that while the power cord is plugged-in and the door is opened, the fan will operate. This is normal operating conditions that no need to be worried.  
 Also note that when the Cooling mode operates, lamp, tray, and fan runs at the same time and "cool" is show on the display.

## MICROWAVE COOKING

This microwave cooking method allows you to cook food for a desired time. In addition to the maximum power level(100%), you can select different microwave power from 9 other levels, 10% to 90% for the foods that require slower cooking. If you have used the appliance for grilling, convection or combination cooking, let the oven cool down before using again. Never switch the microwave oven on when it is empty.

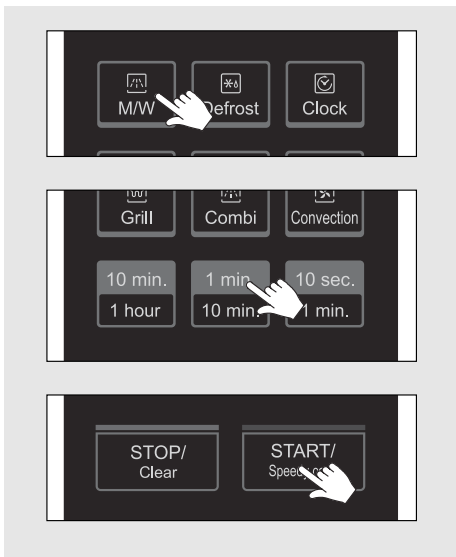

1. Touch the **MW** pad once. **MW** indicator (MW) lights. "P-HI" shows in display.
2. Select the appropriate power level by pressing the **MW** pad again until the corresponding percentage is displayed. Refer to the power level table below for further details.
3. Touch the **time set** pad to set the cooking time. For a cooking time of 5 minutes 30 seconds, Touch the **time set** pad to the right to set 5:30. ( up to 59 minutes 90 seconds) "5:30" shows in display.
4. Touch the **START/SPEEDY COOK** pad. The oven light comes on and the turntable starts rotating. Cooking starts and the time in the display will count down.

**Note :** The oven will automatically work on 100% microwave power if a cooking time is entered without the power level previously being selected. You can check the power level while cooking is in progress by touching the **MW** pad.

**Power level table**

Power level	percentage	Output	Power level	percentage	Output
P-HI	100%	900W	P-50	50%	450W
P-90	90%	810W	P-40	40%	360W
P-80	80%	720W	P-30	30%	270W
P-70	70%	630W	P-20	20%	180W
P-60	60%	540W	P-10	10%	90W
			P-00	0%	0W



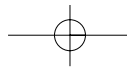

# GRILL COOKING

The Grill enables you to heat and make food to turn brown quickly without using microwave.

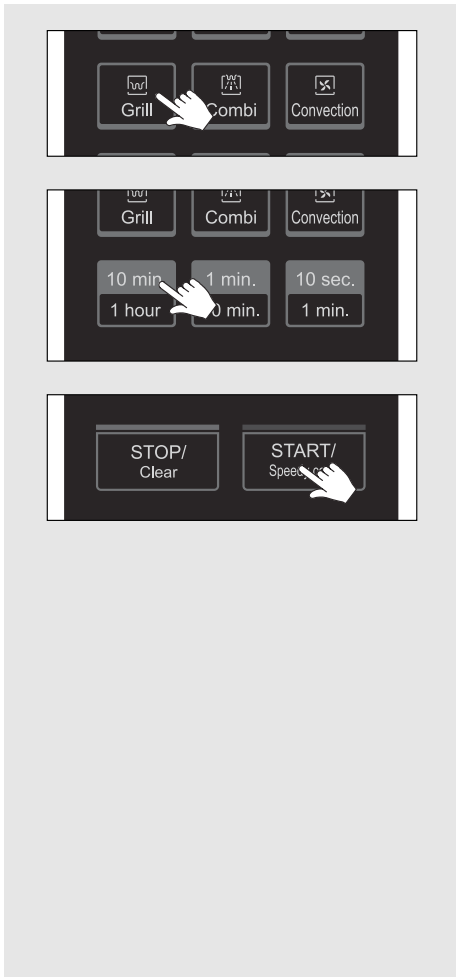

1. Touch the **Grill** pad once. The **GRILL** indicator ( )lights.

2. Touch the **time set** pad to set the grilling time.  
For a grilling time of 11 minutes, touch the time set pad to the right to set 11:00. ( up to 59 minutes 90 seconds )  
"11:00" shows in display.

3. Touch the **START/SPEEDY COOK** pad.  
The oven light comes on and the turntable starts rotating.  
Cooking starts and the time in the display will count down.

**Note :**  
The heating element is located on the top surface of the oven.

**Note :** When first using the grill heater, smoke and odour will be given off.  
To avoid this happening when food is being cooked, turn the heater on with a microwave safe bowl containing 200cc of water in the oven for 10 minutes.  
Place food directly on the rack, in a flat dish or on a heat resistant plate on the rack.

**WARNING :**  
The temperature inside the oven and window is very high.  
Do not touch the oven window and metallic interior of the oven when taking food in and out.  
Use thick oven gloves while handling food or accessories.

Suggested use	Cookware
This method is ideal for toasting bread or muffins. Remember the oven will be hot. Place all food on metal rack.	Use oven-proof cookware. As there is no microwave energy being used you can place metal tins directly onto the metal rack with no danger of arcing.

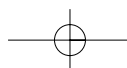

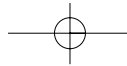

## CONVECTION COOKING(With pre-heat)

For convection cooking, it is recommended to preheat the oven to the appropriate temperature (except for the 40C that displays only) before placing food in the oven.

The maximum preheating time is 30 minutes.

If cooking is not started immediately after preheating, the convection indicator will continue to flash and the preheated oven temperature will be displayed. It will be maintained for 15 minutes; then switch off automatically.



1. Touch the **Convection** pad once. The **CONVECTION** indicator (☒) lights. "180C" shows in display.
2. Select the convection cooking temperature by pressing the **Convection** pad again until the corresponding temperature is displayed.

Temperature sequence
180C → 190C → 200C → 210C → 220C →
40C → 100C → 110C → 120C →
130C → 140C → 150C → 160C → 170C →

3. Touch **START/SPEEDY COOK** pad. The **CONVECTION** indicator (☒) blinks. The temperature of preheating and "PrE-" blink alternatively in the display. The oven will now preheat. When the oven reaches the preheated temperature the oven will beep and the preheated oven temperature will appear in the display. Then open the door and place your food in the oven. The oven temperature now shows in the display.
4. Touch the **time set** pad to set the cooking time. For a cooking time of 11 minutes, touch the **10min & the 1min** pad once to the right to set 11:00.(up to 59 minutes 90 seconds) "11:00" shows in display.
5. Touch the **START/SPEEDY COOK** pad. The oven light comes on and the turntable starts rotating. Cooking starts and the time in the display will count down.

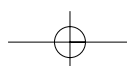

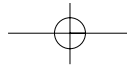

## CONVECTION COOKING(Traditional cooking)

The convection mode enables you to cook food in the same way as in a traditional oven. Microwaves are not used. Always use oven gloves when touching the utensils in the oven, as they will be very hot.



1. Touch the **Convection** pad once. The **CONVECTION** indicator (☐) lights. "180C" shows in display.
2. Select the convection cooking temperature by Touch the **Convection** pad again until the corresponding temperature is displayed.

Temperature sequence
180C → 190C → 200C → 210C → 220C →
40C → 100C → 110C → 120C →
130C → 140C → 150C → 160C → 170C →

3. Touch the **time set** pad to set the cooking time.  
For a cooking time of 11 minutes, touch the **10min & 1min** pad once to the right to set 11:00.(up to 59 minutes 90 seconds)  
"11:00" shows in display.
4. Touch **START/SPEEDY COOK** pad.  
The oven light comes on and the turntable starts rotating.  
Cooking starts and the time in the display will count down.

**Note:** You can check the setting temperature while cooking is in progress by touching the **Convection** pad.

### Fermentation

- 40C of convection cooking temperature is adequate for fermenting bread-like foods.
- High temperatures in the inside of oven may reduce the quality of fermentation. Cool it down to the room temperature before use.

Suggested use	Cookware
This function is ideal for cooking meringues, cookies, biscuits, scones, bread, puddings, large fruit cakes and all pastries. Remember the oven will be hot. Place all food on the metal rack.	Use oven-proof cookware. As there is no microwave energy being used you can place metal tins directly onto the metal rack with no danger of arcing.

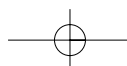

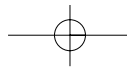

## COMBINATION COOKING

This function allows you to combine convection operation with microwave to produce traditional baked or roasted results in less time. Always use microwave-safe and oven-proof cookware. Glass or ceramic dishes are ideal as they allow the microwaves to penetrate the food evenly.

Always use oven gloves when touching the utensils in the oven, as they will be very hot.

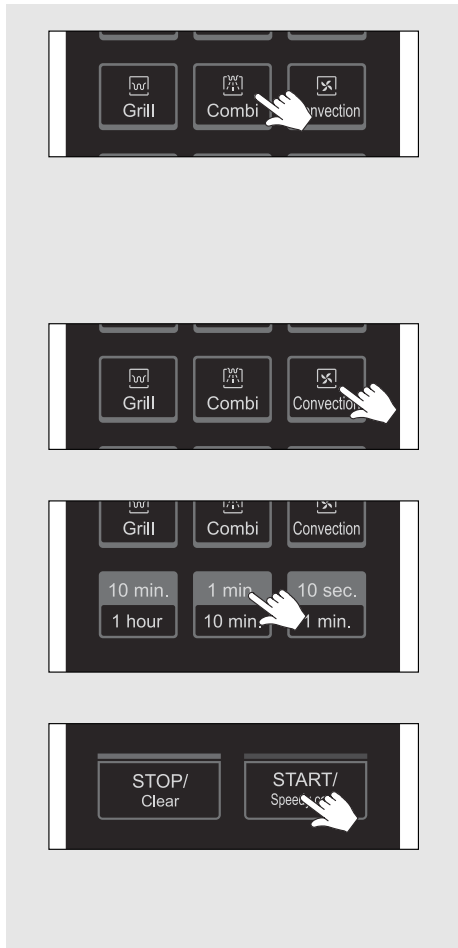

1. Touch the **Combi** pad once.  
The **COMBI** indicator ( ) light and **"C-0"** will show in the display.

2. Select the desired power level.

**For example : C-HI**

Touch the Combi pad once again **"C-HI"** will show in the display.

Display	MW Power
C - 0	30%
C - HI	40%
C - LO	20%

3. Touch **Convection** pad once.

**"180°C"** shows in display.

Select the convection cooking temperature by touching the Convection pad again until the corresponding temperature is displayed.

Temperature sequence
180C → 190C → 200C → 210C → 220C →
100C → 110C → 120C →
130C → 140C → 150C → 160C → 170C →

4. Touch the **time set** pad to set the cooking time.

For a cooking time of 11 minutes, touch the **10min & 1min** pad once to the right to set 11:00. (up to 59 minutes 90 seconds)

**"11:00"** shows in display.

5. Touch the **START/SPEEDY COOK** pad.

The oven light comes on and the turntable starts rotating.

Cooking starts and the time in the display will count down.

**Note :** You can check the cooking temperature while cooking is in progress by touching the **Convection** pad.  
You can check the power level while cook is in progress by touching the **Combi** pad.

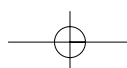



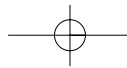

## (1) WEIGHT DEFROST MODE

Weight Defrost automatically sets the defrosting times and power levels to give even defrosting results for frozen food. During the defrosting process the oven will beep to remind you to check the food. When the oven beeps, open the door, turn the frozen food over and close the door, and touch the **START/SPEEDY COOK** pad again.

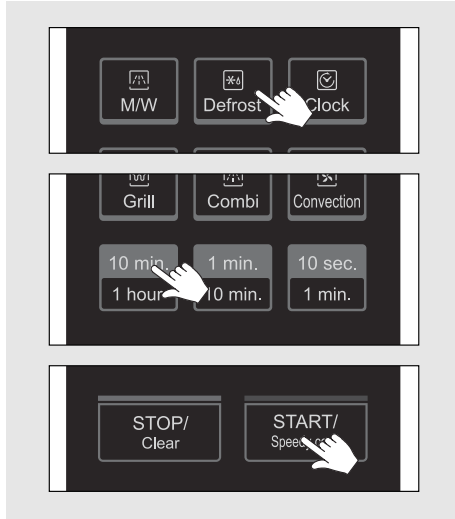

1. Touch the **Defrost** pad once. The **Defrost** indicator (❄) lights and “0” is displayed. The (🔔) indicator blinks. This is a weight defrost mode.
2. Touch the **time set** pad to set the weight. Weight can be set up from 200g to 3000g. The weight will change in 50g increments or decrements. For a defrosting weight of 1000 grams, touch the **10min** pad once to the right to set 1000. “1000” shows in display.
3. Touch the **START/SPEEDY COOK** pad. The oven light comes on and the turntable starts rotating. The (🔔) indicator goes off. Cooking starts and the time in the display will count down.

**Note :** When Weight-Defrosting begins, the defrosting time is automatically determined by the weight entered.

## (2) TIME DEFROST MODE

During the defrosting process the oven will beep to remind you to check the food. When the oven beeps, open the door, turn the frozen food over and close the door, and press the **START/SPEEDY COOK** pad again.

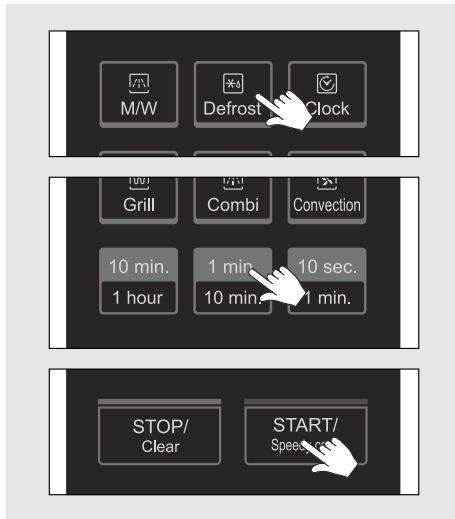

1. Touch the **Defrost** pad twice. The **Defrost** indicator (❄) lights and “:0” is displayed. This is a time defrost mode.
2. Touch the **time set** pad to set the defrosting time. For a time of 11 minutes, touch the **10min & 1min** pad once to the right to set 11:00.(up to 59 minutes 90 seconds) “11:00” shows in display.
3. Touch **START/SPEEDY COOK** pad. The oven light comes on and the turntable starts rotating. Cooking starts and the time in the display will count down.

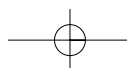

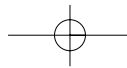

# AUTO COOK

This function allows you to simply and automatically cook a range of popular foods.  
Always use oven gloves when touching the utensils in the oven.



1. Touch the **Auto Cook** pad once.  
The **Auto Cook** indicator (☞) lights.  
"AC-1" will show in the display.
2. Select the menu by touching the **Auto Cook** pad until the required menu is displayed.  
Refer to the auto cook menu chart below for further details.
3. Touch the **time set** pad to set the cooking weight.  
For a cooking weight of 1000 grams, touch the **10min & 1min** pad once to the right to set 1000.( up to 2000 grams )  
"1000" and (☞) shows in display.  
Refer to the auto cook menu chart below for further details.
4. Touch the **START/SPEEDY COOK** pad.  
The oven light comes on and the turntable starts rotating.  
Cooking starts and the time in the display will count down.

**Note :** You can check the current cook setting while the cooking is in progress by touching the **Auto Cook** pad.

**Auto Cook Menu Chart**

Touch auto cook key	Auto Cook Menu	Minimum Weight	Maximum Weight	Weight Step
Once	<b>ROAST PORK</b>	500 g	2000 g	100 g
Twice	<b>ROAST BEEF</b>	500 g	2000 g	100 g
3 times	<b>ROAST CHICKEN</b>	800 g	2000 g	100 g
4 times	<b>BAKED FISH</b>	300 g	900 g	100 g
5 times	<b>FRESH VEGETABLE</b>	100 g	900 g	50 g

Auto Cook Menu	Start Temp.	Method	Cookware
<b>ROAST PORK</b>	Chilled temp.	1. Tie the joint into a neat shape. 2. Place the meat on the dish. 3. Brush with a little oil. 4. Place roasts fat-side down on the dish. 5. Cook on "AUTO COOK-ROAST PORK or ROAST BEEF". 6. Turn over when hearing the beep. 7. Remove from oven. Drain off any excess juices. 8. Stand for 10 minutes in foil before serving.	Glass Turntable + Metal rack
<b>ROAST BEEF</b>			
<b>ROAST CHICKEN</b>	Chilled temp.	1. Wash and dry chicken. Tie the legs loosely together with string. 2. Pierce the skin a couple of times just under the legs. 3. Brush butter mixture all over the chicken on the dish. 4. Place roasts breast-side down on the dish. 5. Cook on "AUTO COOK-ROAST CHICKEN". 6. Turn over when hearing the beep. 7. Remove from oven. Drain off any excess juices. Season with salt if required. Stand for 10 minutes in foil before serving.	Glass Turntable + Metal rack
<b>BAKED FISH</b>	Chilled temp.	1. All types of fresh fish(except battered or breadcrumbed fish) can be cooked whether whole, fillets or steaks. 2. Place the prepared fish in a buttered dish. 3. Season with salt and pepper, sprinkle with lemon juice and dot with butter. Do not cover dish. 4. Place on dish on the metal rack on the turntable. 5. Cook on "AUTO COOK- BAKED FISH".	Micro and heat proof shallow dish. (e.g Pyrex.) Glass Turntable + Metal rack
<b>FRESH VEGETABLES</b>		1. Wash and trim. 2. Place prepared vegetables into a suitable sized container. 3. Sprinkle with 4-5 tbs. of water. 4. Cover with pierced cling film or a lid. 5. Place on dish on the turntable. 6. Cook on "AUTO COOK- FRESH VEGETABLES." * For best results cut vegetables into similar sized pieces.	Microproof dish. (e.g Pyrex.) Glass Turntable

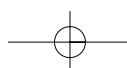

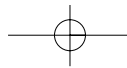

## SPEEDY COOK

The Speedy Cook function allows the oven to cook immediately on microwave full power. The Speedy Cook function has been pre-programmed to increase the cooking time in increments of 30 seconds up to the maximum time of 5 minutes.



1. Touch the **START/SPEEDY COOK** pad.  
The oven will display as “ :30”, **MW** indicator (  ) lights, and the oven starts immediately. You may increase the cooking time by keep touching the **START/SPEEDY COOK** pad.  
The oven light comes on and the turn table starts rotating and the time in the display will count down in seconds.

## DISH WARMER (For Premium option model only)

The DISH WARMER mode allows the oven to Warm dining dishes/plates before serve the food. The premium option model comes with the specially designed Dish-Warm Rack used for the dish warmer mode only. Please take out the glass turntable and place the dish-warm rack at the center of the oven cavity. Then place dishes/plates (Size ranges from Ø150~Ø260mm) on the rack.

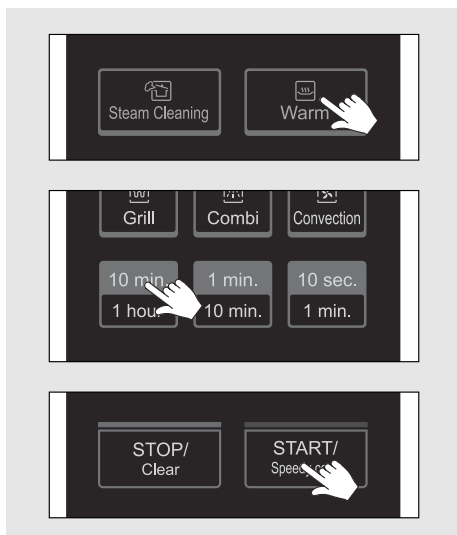
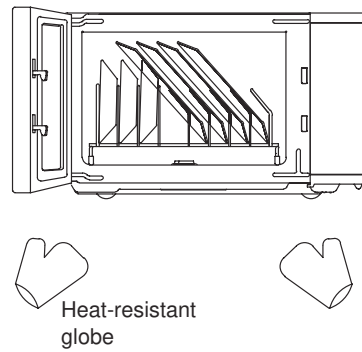
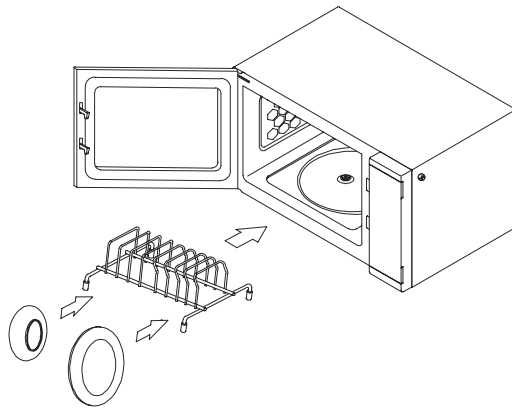

1. Keep press the **WARM** pad to select the desired temperature. (from 40°C~80°C)
2. Touch the **time set** pad to set the desired dish Warm time. (from 10 sec.~ 59 minutes 90 seconds)
3. Touch the **START/SPEEDY COOK** pad.  
The oven light comes on and the turntable starts rotating. Warming starts and the time in the display counts down.

**Note:** Once the dish warmer mode ends, please do not grasp a dish or an rack with your bare hands that it may be hot. We recommend wearing heat-resistant gloves.

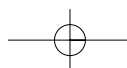

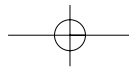

## WARM

The WARM function allows the oven to Warm your food, up to the maximum time of 59 minutes 90 seconds.

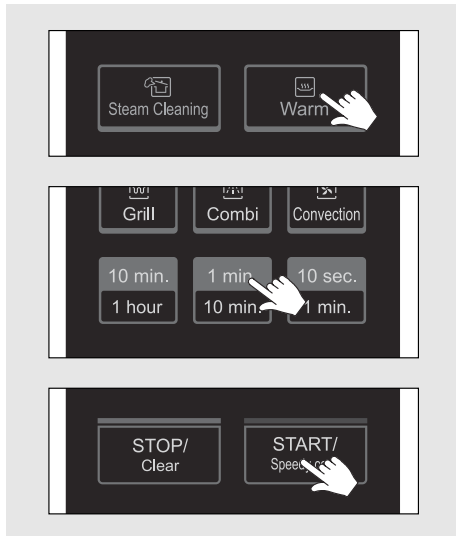

1. Touch the **WARM** pad. (The temperature is about 60 )
2. Touch the **time set** pad to set the cooking time.  
For a cooking time of 11 minutes, touch the **10min & 1min** pad once to the right to set 11:00.(up to 59 minutes 90 seconds)  
"11:00" shows in display.
3. Touch the **START/SPEEDY COOK** pad.  
The oven light comes on and the turntable starts rotating.  
Warming starts and the time in the display will count down.

## STEAM CLEANING

This function uses steam to clean the inside of oven.

Before cleaning, put 150~200cc water in a mug cup or a small bowl and place it at the centre of the tray.

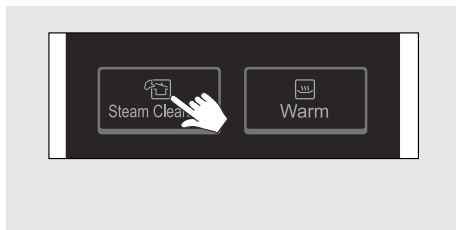

1. Touch the **STEAM CLEANING** pad. The STEAM indicator ( ) lights.  
The oven heats up for 10minutes.  
When heating up is complete the "door" "oPEn" blinks on the display.  
You may remove the mug cup and use the moisture in the oven to clean the inside of oven cavity.
2. After heating up ends, "door" "oPEn" shows on the display for 5 minutes.  
Once it passes 5minutes, automatic cooling mode starts.

**Note:** High temperature in the inside of oven may reduce the effect of steam power.  
Cool it down to the room temperature before use.

## REMINDER MODE (Function to remind cooking complete)

To remind you that you have food in the oven, the oven will beep once a minute until you either open the oven door or press any pad.

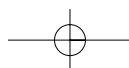

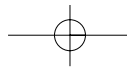

## TO STOP THE OVEN WHILE THE OVEN IS OPERATING

---

1. Open the door.
  - Oven stops operating.
  - You can restart the oven by closing the door and touching the **START/SPEEDY COOK** pad.
2. Touch the **STOP/CLEAR** pad.
  - Oven stops operating.
  - If you wish to cancel the cooking settings, press the **STOP/CLEAR** pad again.

## ABNORMAL MESSAGE

---

- If the inside temperature of the oven is higher than expected or the temperature sensor doesn't work properly, "**Err 2**" message will be shown in the display.
- Unplug the power and call our technical service.
- When the temperature sensor is disconnected, "**Err 3**" message will be shown in the display.
- Unplug the power and call our technical service.

## ARCING

---

*If you see arcing, touch **STOP/CLEAR** pad and correct the problem.*

Arcing is the microwave term for sparks in the oven. Arcing is caused by:

- Metal or foil touching the side of the oven.
- Foil not molded to food (upturned edges act like antennas).
- Metal, such as twist-ties, poultry pins, or gold rimmed dishes, in the microwave.
- Recycled paper towels containing small metal pieces being used in the microwave.

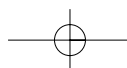

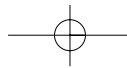

## GENERAL GUIDE LINES

Since microwave cooking to some extent is different from traditional cooking, the following general guidelines should be considered whenever you use your microwave oven

### If the food is undercooked

Check if:

- You have selected the correct power level.
- The selected time is sufficient-the times given in the recipes are approximate. They depend on initial temperature, weight and density of the food etc.
- The container is appropriate.

### If the food is overcooked,i.e. dried out or burnt

Before you cook again, consider whether:

- The power level was too high.
- The set time was too long-the times in the recipes are approximate. They depend on initial temperature, weight and density of the food etc.

### Points to remember when defrosting

- The shape of the package alters the defrosting time. Shallow rectangular packets defrost more quickly than a deep block. Separate pieces as they begin to defrost; free flow slices defrost more easily.
- Shield areas of food with small pieces of foil if they start to become warm.
- When defrosting, it is better to under thaw the food slightly and allow the process to finish during the standing time.

### The amount of food

The more food you want to prepare the longer it takes. A rule of thumb is that double amount of food requires almost double the time. If one potato takes four minutes to cook, approximately seven minutes are required to cook two potatoes.

### Starting temperature of food

The lower the temperature of the food which is being put into the microwave oven, the longer time it takes. Food at room temperature will be reheated more quickly than food at refrigerator temperature.

### Composition of the food

Food with a lot of fat and sugar will be heated faster than food containing a lot of water. fat and sugar will also reach a higher temperature than water in the cooking process.

The more dense the food, the longer it takes to heat. "Very dense" food like meat takes longer time to reheat than lighter, more porous food like sponge cakes.

### Size and shape

Smaller pieces of food will cook more quickly than larger pieces and uniform pieces of food cook more evenly than irregularly shaped foods.

With unevenly shaped food, the thinner parts will cook faster than the thicker areas. Place the thinner chicken wings and legs to the centre of the dish.

### Stirring, turning of foods

Stirring and turning of foods are techniques used in conventional as well as in microwave cooking to distribute the heat quickly to the centre of the dish and avoid over-cooking at the outer edges of the food.

### Covering food helps:

- To reduce spattering
  - To shorten cooking times
  - To retain food moisture
- All covering, which will allow microwaves to pass through are suitable-See above "Which utensils can be used in the oven?"

### Releasing pressure in foods

Several foods are tightly covered by a skin or membrane. These foods should be pricked with a fork or cocktail stick to release the pressure and to prevent bursting, as steam builds up within them during cooking. This applies to potatoes, chicken livers, sausages, egg yolks and some fruits.

### Standing time

Always allow the food to stand for some time after using the oven. standing time after defrosting, cooking/reheating always improves the result since the temperature will then be evenly distributed through out the food.

In a microwave oven foods continue to cook even when the microwave energy is turned off. They are no longer cooking by microwaves, but they are still being cooked by the conduction of the high residual heat to the centre of the food.

The length of standing time depends on the volume and density of the food. Sometimes it can be as short as the time it takes you to remove the food from the oven and take it to the serving table. However, with larger, denser foods, the standing time may be as long as 10 minutes. During 'standing', the internal temperature of the food will rise by as much as 8°C and the food will finish cooking in this time.

### Arranging food

This is done in several ways in microwave cooking to give more even cooking results.

If you are cooking several items of the same food such as jacket potatoes, place them in a ring pattern for uniform cooking. When cooking foods of uneven shapes or thickness, place the smaller or thinner area of the food towards the centre of the dish where it will be heated last.



Uneven foods such as fish should be arranged in the oven with the tails to the centre.

If you are saving a meal in the refrigerator or 'plating' a meal for reheating, arrange the thicker, denser foods to the outside of the plate and the thinner or less dense foods in the middle.



Place thin slices of meat on top of each other or interlace them. Thicker slices such as meat loaf and sausages have to be placed close to each other. Gravy or sauce should be reheated in a separate container.



Choose a tall, narrow container rather than a low and wide container. When reheating gravy, sauce or soup, do not fill the container more than 2/3.



When you cook or reheat whole fish, score the skin this prevents cracking. Shield the tail and head with small pieces of foil to prevent over-cooking but ensure the foil does not touch the sides of the oven.

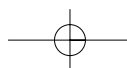

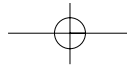

## KEEP THE OVEN CLEAN

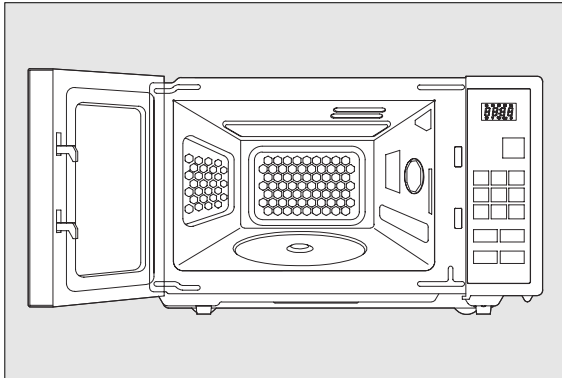

### INSIDE THE OVEN

The interior three side walls and floor are stainless steel. For easy cleaning, wipe spills and spatters as they occur with a damp cloth or sponge with water and a mild detergent. Rinse the cavity of any cleaning residue with a clean damp or sponge after cleaning. Dry with a soft cloth.

These areas can also be cleaned by using plastic or nylon scouring pads recommended for use of Teflon and Silverstone\*.

For hard to remove soil, use a mild non-abrasive cleaner. Use on the stainless steel areas, turntable and rotating base only.

### TOP SURFACE

Sheath and Quartz grill elements are installed on the top surface. As they are fragile, be careful not to press or grip them hard. Do not remove the grill elements to clean the surface.

### Warning

Just as your traditional oven becomes hot also this oven will become hot during use of the grill functions or in combination with microwaves. Children should be supervised at all times when using the oven.

### TURNTABLE OR ROTATING BASE

Turntable or Rotating Base parts (depending on the model) are easily removable for cleaning. The turntable should be cleaned frequently and is dishwasher proof.

If food spills are accumulated under the rotating base, the oven will not operate efficiently. Be sure to wipe up any spills as they occur in this area.

Clean these parts as described by the same method of cleaning inside the oven. Be sure to properly reinstall these parts into the cavity after cleaning.

### Note:

Do not use any other Turntable in the oven. Do not operate the oven without the Turntable or the Rotating Base positioned properly in place.

### DOOR

While the oven door is still warm, any spatters or food soils should be wiped off with a damp sudsy cloth or sponge. Rinse with water and wipe dry with a cloth.

If steam or condensation appears around this area, wipe with a cloth. This may occur when the oven is operating under high humidity and with foods containing lots of moisture. This is a normal part of microwave cooking.

### Note:

- Although your oven is provided with safety features, it is important to observe the following:
  1. It is important not to defeat or tamper with safety interlocks.
  2. Do not place any object between the oven front face and the door or allow residue to accumulate on sealing surfaces. Wipe the sealing area frequently with a mild detergent, rinse and dry. Never use abrasive powders or pads.
  3. When opened, the door must not be subjected to strain, for example, a child hanging on an opened door or any load could cause the oven to fall forward to cause injury and also damage to the door. Do not operate the oven if it is damaged, until it has been repaired by a service technician. It is particularly important that the oven closes properly and that there is no damage to the:
    - 1) Door (bent)
    - 2) Hinge and Hooks (broken or loosened)
    - 3) Door seals and sealing surface.
  4. The oven should not be adjusted or repaired by anyone except a properly competent service technician.
  5. The oven should be cleaned regularly and any food deposits removed;
  6. Failure to maintain the oven in a clean condition could lead to deterioration of the surface that could adversely affect the life of the appliance and possibly result in a hazardous situation;

### EXTERIOR

#### CONTROL PANEL

Exercise care when cleaning this area is necessary. To clean, wipe the panel with a slightly dampened cloth, using only water.

Wipe dry. Do not scrub this area or use any sort of chemical cleaner. Avoid use of excess water.

#### OUTSIDE SURFACE

The outside surfaces should be cleaned with soap and water, rinsed and dried with a soft cloth. Do not use any type of household or abrasive cleanser.

### Note:

- DO NOT USE ANY TYPE OF OVEN CLEANER ON ANY PART OF THE OVEN. It will damage some of the interior and exterior surfaces of the oven.
- The oven should be cleaned regularly and any food deposits removed.
- Failure to maintain the oven in a clean condition could lead to deterioration of the surface that could adversely affect the life of the appliance and possibly result in a hazardous situation.

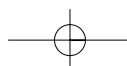

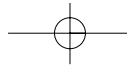

## BEFORE CALLING FOR SERVICE

You can often correct operating problems yourself. If your microwave/grill oven fails to work properly, locate the operating problem in the chart below and try the solutions marked for each problems.

If the microwave/grill oven still does not work properly, contact the nearest Service Centre.

**Note:**

It is quite normal for steam to be emitted around the door during the cooking cycle. The door is not intended to seal the oven cavity completely but its special design contributes to the complete safety of the appliance.

**Caution:**

1. Do not attempt to operate the oven while empty as this will cause damage.
2. As an exhaust is located in the rear of the oven, install the oven so as not to block the outlet.  
If the microwave/grill oven still does not work properly, contact the nearest Service Centre.

PROBLEM		1	2	3	4	5	6	7	8	9	10	11	12
Oven will not start		X	X	X	X								
Arcing or sparking						X	X						
Unevenly cooked foods						X		X	X	X			
Overcooked foods											X		
Undercooked foods						X				X	X	X	
Improper defrosting						X		X	X		X		X

SOLUTION		1	2	3	4	5	6	7	8	9	10	11	12
Is start pad pressed?		X	X	X	X								
Is power cord plugged in?						X							
Is door closed?							X	X					
Set the cooking time.									X	X	X		
Use approved cookware only.													
Do not operate with oven empty.							X	X					
Supplied tray must be used.													
Turn of stir food.													
Completely defrost food.													
Press correct Function pads													
Check to see that oven ventilation parts are not blocked.													
Do "manual cooling" over 10 minutes.													X



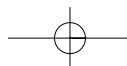

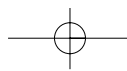

## QUESTIONS AND ANSWERS

**\* Q : Will the microwave oven be damaged if it operates while empty?**

A : Operating the oven empty in MW mode can cause damage to the oven. We strongly recommend NOT to run the oven empty.

**\* Q : Can the oven be used with the tray removed?**

A : No. The tray must always be used in the oven before cooking.

**\* Q : Can I open the door when the oven is operating?**

A : The door can be opened anytime during the cooking operation. Then microwave energy will be instantly switched off and the time setting will maintain until the door is closed.

**\* Q : Why do I have moisture in my microwave oven after cooking?**

A : The moisture on the side of your microwave oven is normal. It is caused by steam from cooking food hitting the cool oven surface.

**\* Q : Does microwave energy pass through the viewing screen in the door?**

A : No. The metal screen bounces back the energy to the oven cavity. The holes are made to allow light to pass through. They do not let microwave energy pass through.

**\* Q : Why do eggs sometimes pop?**

A : When baking or poaching eggs, the yolk may pop due to steam build-up inside the yolk membrane. To prevent this, simply pierce the yolk with a toothpick before cooking. Never cook eggs without piercing their shells.

**\* Q : Why this standing time recommended after the cooking operation has been completed?**

A : Standing time is very important.  
With microwave cooking, the heat is in the food, not in the oven. Many foods build up enough internal heat to allow the cooking process to continue, even after the food is removed from the oven. Standing time for joints of meat, large vegetables and cakes is to allow the inside to cook completely, without overcooking the outside.

**\* Q : What does “standing time” mean?**

A : “Standing time” means that food should be removed from the oven and covered for additional time to allow it to finish cooking. This frees the oven for other cooking.

**\* Q : Why does my oven not always cook as fast as the microwave cooking guide says?**

A : Check your cooking guide again, to make sure you’ve followed directions exactly ; and to see what might cause variations in cooking time. Cooking guide times and heat settings are suggestions, to help prevent overcooking... the most common problem in getting used to a microwave oven.

Variations in the size, shape and weights and dimensions could require longer cooking time. Use your own judgement along with the cooking guide suggestions to check whether the food has been properly cooked just as you would do with a conventional cooker.

**\* Q : Can I operate my microwave oven without the turntable or overturn the turntable to hold a large dish?**

A : No. If you remove or overturn the turntable, you will get poor cooking results. Dishes used in your oven must fit on the turntable.

**\* Q : Is it normal for the turntable to turn in either direction?**

A : Yes. The turntable rotates clockwise or counterclockwise, depending on the rotation of the motor when the cooking cycle begins.

**\* Q : Can I pop popcorn in my microwave oven? How do I get the best results?**

A : Yes. Pop packaged microwave popcorn following manufacture’s guidelines. Do not use regular paper bags. Use the “listening test” by stopping the oven as soon as the popping slows to a “pop” every 1 or 2 seconds. Do not repop unpopped kernels. Do not pop popcorn in glass cookware.

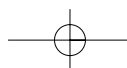

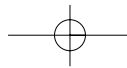

## SPECIFICATIONS

Power supply		230V~, 50Hz
Microwave	Power consumption	1400W
	Output power	900W (IEC 705)
	Frequency	2,450MHz
Grill power consumption		1250W
Convection power consumption		1250W
Combination power consumption		2700W
Outside Dimension(WXDXH)		513(20.2)x401(15.8)x311(12.2)mm (inch)
Cavity Dimensions(WXDXH)		354(13.9)x341(13.4)x231(9.1)mm (inch)
Net Weight		Approx. 16.6Kg (36.6 lbs.)
Timer		59 minutes 90 seconds
Select function		Microwave / Grill / Convection / Combination
Microwave power level		10 stages

\* Specifications are subject to change without notice.

## PRINCIPLE OF MICROWAVE

Microwave oven is a Group 2 ISM equipment in which radio-frequency energy is intentionally generated and used in the form of electromagnetic radiation for the treatment of material. This oven is a Class B equipment suitable for use in domestic establishments and in establishments directly connected to a low voltage power supply network which supplies buildings used for domestic purposes.

## DISPOSAL OF USED ELECTRICAL & ELECTRONIC EQUIPMENT



The meaning of the symbol on the product, its accessory or packaging indicates that this product shall not be treated as household waste. Please, dispose of this equipment at your applicable collection point for the recycling of electrical & electronic equipments waste. In the European Union and Other European countries which there are separate collection systems for used electrical and electronic product. By ensuring the correct disposal of this product, you will help prevent potentially hazardous to the environment and to human health, which could otherwise be caused by unsuitable waste handling of this product. The recycling of materials will help conserve natural resources. Please do not therefore dispose of your old electrical and electronic equipment with your household waste. For more detailed information about recycling of this product, please contact your local city office, your household waste disposal service or the shop where you purchased the product.

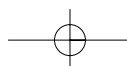

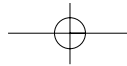

# COOKING TECHNIQUES

## STANDING TIME

Dense foods e.g. meat, jacket potatoes and cakes, require standing time(inside or outside of the oven) after cooking, to allow heat to finish conducting to cook the center completely. Wrap meat joints and jacket potatoes in aluminium foil while standing. Meat joints need approx. 10-15 minutes, jacket potatoes 5 minutes. Other foods such as plated meal, vegetables, fish etc require 2-5 minutes standing. After defrosting food, standing time should also be allowed. If food is not cooked after standing time, return to the oven and cook for additional time.

## MOISTURE CONTENT

Many fresh foods e.g. vegetables and fruit, vary in their moisture content throughout the season, particularly jacket potatoes. For this reason cooking times may have to be adjusted. Dry ingredients e.g. rice, pasta, can dry out during storage so cooking times may differ.

## DENSITY

Porous airy foods heat more quickly than dense heavy foods.

## CLING FILM

Cling film helps keep the food moist and the trapped steam assists in speeding up cooking times. Pierce before cooking to allow excess steam to escape. Always take care when removing cling film from a dish as the build-up of steam will be very hot.

## SHAPE

Even shapes cook evenly. Food cooks better by microwave when in a round container rather than square.

## SPACING

Foods cook more quickly and evenly if spaced apart. NEVER pile foods on top of each other.

## STARTING TEMPERATURE

The colder the food, the longer it takes to heat up. Food from a fridge takes longer to reheat than food at room temperature.

## LIQUIDS

All liquids must be stirred before and during heating. Water especially must be stirred before and during heating, to avoid eruption. Do not heat liquids that have previously been boiled. DO NOT OVERHEAT.

## TURNING & STIRRING

Some foods require stirring during cooking. Meat and poultry should be turned after half the cooking time.

## ARRANGING

Individual foods e.g. chicken portions or chops, should be placed on a dish so that the thicker parts are towards the outside.

## QUANTITY

Small quantities cook faster than large quantities, also small meals will reheat more quickly than large portions.

## PIERCING

The skin or membrane on some foods will cause steam to build up during cooking. These foods must be pierced or a strip of skin should be peeled off before cooking to allow the steam to escape. Eggs, potatoes, apples, sausages etc, will all need to be pierced before cooking. DO NOT ATTEMPT TO BOIL EGGS IN THEIR SHELLS.

## COVERING

Cover foods with microwave cling film or a lid. Cover fish, vegetables, casseroles, soups. Do not cover cakes, sauces, jacket potatoes or pastry items.

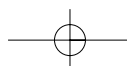

## DEFROSTING GUIDE

- ▶ Do not defrost covered meat. Covering might allow cooking to take place. Always remove outer wrap and tray. Use only containers that are microwave-safe.
- ▶ Begin defrosting whole poultry breast-side-down. Begin defrosting roasts fat-side-down.
- ▶ The shape of the package alters the defrosting time. Shallow rectangular shapes defrost more quickly than a deep block.
- ▶ After  $\frac{1}{3}$  of the defrost time has elapsed, check the food. You may wish to turn over, break apart, rearrange or remove thawed portions of the food.
- ▶ During defrost, the oven will prompt you to turn the over. At this point, open oven door and check the food. Follow the techniques listed below for optimum defrost results. Then, close oven door, touch the START pad to complete defrosting.
- ▶ When defrosted, food should be cool, but softened in all areas. If still slightly icy, return to microwave oven very briefly, or let stand a few minutes. After defrosting, allow food to stand 5-60 minutes if there are any icy areas. Poultry and fish may be placed under running cool water until defrosted
- ⇒ **Turn over** : Roast, ribs, whole poultry, turkey breasts, hot dogs, sausages, steaks, or chops.
- ⇒ **Rearrange** : Break apart or separate steaks, chops, hamburger patties, ground meat, chicken or seafood pieces, chunks of meat such as stew beef.
- ⇒ **Shield** : Use small strips of aluminum foil to protect thin areas or edges of unevenly shaped foods such as chicken wings. To prevent arching, do not allow foil to come within 1-inch of oven walls or door.
- ⇒ **Remove** : To prevent cooking, thawed portions should be removed from the oven at this point. This may shorten defrost time for food weighing less than 3 lbs.(1350g).

## Cooking chart

Item	Power Level	Cooking Time Per lb./450g	Special Instruction
<b>MEAT</b>			
Beef joint -Rare	P-80	6-8 min.	- Chilled meat and poultry should be removed from the refrigerator at least 30 minutes before cooking. - Always let the meat and poultry stand, covered after cooking.
-Medium	P-80	7-9 min.	
-well done	P-80	9-11 min.	
Pork Joint	P-HI	10-13 min.	
Bacon joint	P-HI	8-10 min.	
<b>POULTRY</b>			
Whole chicken	P-HI	4-9 min.	
Portions chicken	P-80	5-7 min.	
Breast (boned)	P-80	6-8 min.	
<b>FISH</b>			
Fish Fillets	P-HI	3-5 min.	- Brush a little oil or melted butter over the fish, or add 15~30ml(1-2 tbsp) lemon juice, wine, stock, milk or water. - Always let the fish stand, covered, after cooking
Whole Mackerel, Cleaned and prepared	P-HI	3-5 min.	
Whole Trout, Cleaned & Prepared	P-HI	4-6 min.	
Salmon steaks	P-HI	4-6 min.	
<b>NOTE</b> : The above times should be regarded only as a guide. Allow for difference in individual tastes and preferences. The times may vary due to the shape, cut, and composition of the food. Frozen meat, poultry and fish must be thoroughly thawed before cooking.			

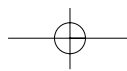

# COOKING & REHEATING CHART

## Reheating chart

- Baby food particularly needs to be checked carefully before serving to prevent burns.
- When heating pre-packaged ready-cooked foods, always follow the pack instructions carefully.
- If you freeze foods which were bought from the fresh or chilled counters, remember that they should be thoroughly thawed before following the heating instructions on the packed. It's worth putting a note on them so that other members of the household will remember too.
- Remember metal ties and transfer food from foil containers before reheating.
- Chilled(refrigerated) food takes longer to reheat than food at room temperature (such as just-cooled food or food from the store cupboard).
- All foods should be reheated using full microwave power.

Item	Cooking time	Special Instructions
Baby food 128g jar	20 sec.	Empty into a small serving bowl. Stir well once or twice during heating. Before serving, check the temperature carefully.
Baby milk 100ml / 4fl.oz. 225ml / 8fl.oz.	20-30 sec. 40-50 sec.	Stir or shake well and pour into a sterilized bottle. Before serving, shake well and check the temperature carefully.
Sandwich roll or bun 1 roll	20-30 sec.	Wrap in paper towel and place on glass microwaveable rack. <b>*Note : Do not use recycled paper towels.</b>
Lasagna 1 serving (10 1/2 oz./300g)	4-6 min.	Place lasagna on microwaveable plate. Cover with plastic wrap and vent.
Casserole 1 cup 4 cups	1 1/2-3 min. 5-7 min.	Cook covered in microwaveable casserole. Stir once halfway through cooking.
Mashed potatoes 1 cup 4 cups	2-3 min. 6-8 min.	Cook covered in microwaveable casserole. Stir once halfway through cooking.
Baked beans 1 cup	2-3 min.	Cook covered in microwaveable casserole. Stir once halfway through cooking.
Ravioli or pasta in sauce 1 cup 4 cups	2-3 min. 6-9 min.	Cook covered in microwaveable casserole. Stir once halfway through cooking.

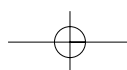

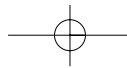

# VEGETABLE CHART

Use a suitable glass pyrex bowl with lid. Add 30-45ml cold water(2-3 tbsp.) for every 250g unless another water quantity is recommended - see table. Cook covered for the minimum time - see table.

Continue cooking to get the result you prefer. Stir once during and once after cooking. Add salt, herbs or butter after cooking.

Cover during a standing time of 3 minutes.

Hint : cut the fresh vegetables into even sized pieces. The smaller they are cut, the quicker they will cook.

All vegetables should be cooked using full microwave power.

## Cooking Guide for fresh vegetables

Vegetables	Weight	Time	Comments
Broccoli	1/2 lb./250g 1 lb./500g	2-3 min 4-6 min	Prepare even sized florets. Arrange the stems to the centre.
Brussels sprouts	1/2 lb./250g	3-4 min	Add 60-75ml(5-6tbsp.) water.
Carrots	1/2 lb./250g	2-3 min	Cut carrots into even sized slices.
Cauliflower	1/2 lb./250g 1 lb./500g	2-3 min 4-6 min	Prepare even sized florets. Cut big florets into halves. Arrange stems to the centre.
Courgettes	1/2 lb./250g	2-3 min	Cut courgettes into slices. Add 30ml(2tbsp.) water or a knob of butter. Cook until just tender.
Egg plants	1/2 lb./250g	2-3 min	Cut egg plants into small slices and sprinkle with 1 tablespoon lemon juice.
Leeks	1/2 lb./250g	2-3 min	Cut leeks into thick slices.
Mushrooms	0.3 lb./125g 1/2 lb./250g	1-2 min 2-4 min	Prepare small whole or sliced mushrooms. Do not add any water. Sprinkle with lemon juice. Spice with salt and pepper. Drain before serving.
Onions	1/2 lb./250g	2-3 min	Cut onions into slices or halves. Add only 15ml(1tbsp.) water.
Pepper	1/2 lb./250g	2-4 min	Cut pepper into small slices.
Potatoes	1/2 lb./250g 1 lb./500g	4-6 min 7-9 min	Weigh the peeled potatoes and cut them into similar sized halves or quarters.
Turnip cabbage	1/2 lb./250g	4-6 min	Cut turnip cabbage into small cubes.

## Cooking Guide for frozen vegetables

Vegetables	Weight	Time	Instructions
spinach	0.3 lb./125g	1-2 min	Add 15ml(1tbsp.) cold water.
broccoli	1/2 lb./250g	2-3 min	Add 30ml(2 tbsp.) cold water.
Peas	1/2 lb./250g	2-3 min	Add 15ml(1 tbsp.) cold water.
Green beans	1/2 lb./250g	2-4 min	Add 30ml(2t tbsp.) cold water.
Mixed vegetables (carrots/peas/corn)	1/2 lb./250g	2-3 min	Add 15ml(1tbsp.) cold water.
Mixed vegetables (Chinese style)	1/2 lb./250g	2-4 min	Add 15ml(1 tbsp.) cold water.

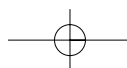

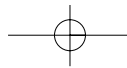

# RECIPES

## TOMATO & ORANGE SOUP

1 oz.(25g) butter  
 1 medium onion, chopped  
 1 large carrot & 1 large potato, chopped  
 1<sup>3</sup>/<sub>4</sub>lb(800g) canned, chopped tomatoes  
 juice and grated rind of 1 small orange  
 1<sup>1</sup>/<sub>2</sub>pints(900ml) hot vegetable stock  
 salt and pepper to taste

1. Melt the in a large bowl on P-HI for 1 minute.
2. Add the onion, carrot and potato and cook on P-HI for 3 minutes. stir halfway through cooking.
3. Add the tomatoes, orange juice, orange rind and stock. Mix thoroughly. Season with salt and pepper to taste. Cover the bowl and cook on P-HI for 13 minutes. stir 2-3 times during cooking, until the vegetables are tender.
4. Blend and serve immediately.

## FRENCH ONION SOUP

1 large onions, sliced  
 1 tbsp (15ml) corn oil  
 2 oz.(50g) plain flour  
 2 pints(1.2 liters) hot meat  
 or vegetable stock  
 salt and pepper to taste  
 2 tbsp (30ml) parsley, chopped  
 4 thick slices French bread  
 2 oz.(50g) cheese, grated

1. Place the onion and oil a bowl, mix well and cook on P-HI for 1 minutes.
2. Stir in the flour to make a paste and gradually add stock. Season and add the parsley.
3. Cover the bowl and cook on P-70 for 14 minutes.
4. Pour the soup into serving bowls, submerge bread and sprinkle generously with cheese.
5. Cook on P-70 for 2 minutes, until the cheese has melted.

## STIR FRIED VEGETABLES

1 tbsp(15ml) sunflower oil  
 2 tbsp (30ml) soy sauce  
 1 tbsp (15ml) sherry  
 1"(2.5cm) root ginger,  
 peeled and finely grated  
 2 medium carrots, cut into fine strips  
 4 oz.(100g) button mushrooms,  
 chopped  
 2 oz.(50g) beansprouts  
 4 oz.(100g) mange-tout  
 1 red pepper, seeded and thinly sliced  
 4 spring onions, chopped  
 4 oz.(100g) canned water chestnuts,  
 sliced  
 1/4 head of chinese leaves, thinly sliced

1. Place the oil, soy sauce, sherry, ginger, garlic and carrots in a large bowl, mix thoroughly
2. Cover and cook on P-HI for 2-4 minutes, stirring once.
3. Add the button mushrooms, beansprouts, mange-tout, red pepper, spring onions, water chestnuts and chinese leaves. Mix thoroughly.
4. Cook on P-HI for 5-6 minutes, until the vegetables are tender. Stir 2-3 times during cooking.

***Stir fried vegetables are ideally served with meat or fish.***

## HONEYED CHICKEN

4 boneless chicken breasts  
 2 tbsp(30ml) clear honey  
 1 tbsp(15ml) whole grain mustard  
 1/2 tsp(2.5ml) dried tarragon  
 1 tbsp(15ml) tomato puree  
 1/4 pint(150ml) chicken stock

1. Place the chicken breasts in a casserole dish.
2. Mix all remaining ingredients together and pour over the chicken. Salt and pepper to taste.
3. Cook on P-HI for 12-13 minutes. Rearrange and coat the chicken with the sauce twice during cooking.

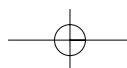

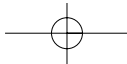

## BLUE CHEESE & CHIVE JACKETS

2 baking potatoes,  
(approx.9 oz.(250g) each)  
2 oz.(50g) butter  
4 oz.(100g) blue cheese, chopped  
1 tbsp(15ml) fresh chives, chopped  
2 oz.(50g) mushrooms, sliced  
salt and pepper to taste

1. Prick each potato in several places. Cook on P-HI for 7-9 minutes. Halve and scoop the flesh into a bowl, add the butter, cheese, chives, mushrooms, salt and pepper, mix thoroughly.
2. Pile mixture into the potato skins and place in a flan dish.
3. Cook on P-50 for 10 minutes.

## WHITE SAUCE

1 oz.(25g) butter  
1 oz.(25g) plain flour  
1/2 pint(300ml) milk  
salt and pepper to taste

1. Place the butter in a bowl and cook on P-HI for 1 minute, until melted.
2. Stir in the flour and whisk in the milk. Cook on P-HI for 3-4 minutes, stirring every 2 minutes until thick and smooth. Season with salt and pepper to taste.

## STRAWBERRY JAM

1 1/2 lb.(675g) strawberries, hulled  
3 tbsp(45ml) lemon juice  
1 1/2 lb.(675g) caster sugar

1. Place strawberries and lemon juice in a very large bowl, heat on P-HI for 4 minutes, or until the fruit has softened. Add sugar, mix well.
2. Cook on P-70 for 20-25 minutes, until setting point\* is reached, stir every 4-5 minutes.
3. Pour into hot, clean jars. Cover, seal and label.

*\* setting point : To determine setting point, place 1 tsp(5ml)jam onto chilled saucer. Allow to stand for 1 minute. Move surface of jam gently with your finger, if the surface wrinkles setting point has been reached.*

## PLAIN MICROWAVE CAKE

4 oz.(100g) margarine  
4 oz.(100g) sugar  
1 eggs  
4 oz.(100g) self raising flour, sifted  
2-3 tbsp(30-45ml) milk

1. line the base of 8" (20.4cm) cake dish with grease-proof paper.
2. Cream the margarine and sugar together until light and fluffy. Beat in the eggs and fold in the sifted flour alternately with the milk.
3. Pour into prepared container. Cook on P-HI for 4-5 minutes, until a skewer comes out cleanly.
4. Leave the cake to stand for 5 minutes before turning out.

## OMELETTES

1/2 oz.(15g) butter  
4 eggs  
6 tbsp(90ml) milk  
salt & pepper

1. Whisk together eggs and milk.
2. Place butter in 10"(26cm) flan dish. Cook on P-HI for 1 minute, until melted. Coat the dish with the melted butter.
3. Pour omelette mixture into flan dish. Cook on P-HI for 2 minutes. whisk mixture and cook again on P-HI for 1 minutes.

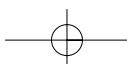



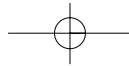

## SCRAMBLED EGG

1/2 oz.(15g) butter  
2 eggs  
2 tbsp(30ml) milk  
salt & pepper

1. Melt the butter in a bowl on P-HI for 1 minute.
2. Add the eggs, milk and seasoning and mix well.
3. Cook on P-HI for 3 minutes, stirring every 30 seconds.

## SAVORY MINCE

1 small onion, diced  
1 clove garlic, crushed  
1 tsp(5ml) oil  
7 oz.(200g) can chopped tomatoes  
1 tbsp(15ml) tomato puree  
1 tsp(5ml) mixed herbs  
8 oz.(225g) minced beef  
salt and pepper

1. Place onion, garlic and oil in casserole, and cook on P-HI for 2 minutes or until soft.
2. Place all other ingredients in casserole. Stir well.
3. Cover and cook on P-HI for 5 minutes then P-50 for 8-13 minutes or until the meat is cooked.

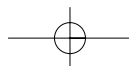
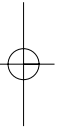

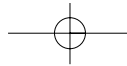

# ABOUT THIS MANUAL

VISION CREATIVE, INC.  
 서울 종로구 통의동  
 6번지 이룸빌딩 4층

담 당	이재혁 님		
F.MODEL	KOC-9Q1T7S	브랜드	DAEWOO
B.MODEL	KOC-9Q1T	언 어	영어
BUYER	영문기본	COUNTRY	
일 정	1차		
	2차		
	3차		
	4차		
	5차		
제 판	한	인쇄	
<b>MEMO</b> 총 26p 08.08.27-표지, 7p, 8p, 9p, 10p, 11p, 12p, 13p, 14p, 15p, 16p, 17p, 18p, 19p, 20p, 22p, 25p 수정_ 신규 17p 08.09.04-9p, 11p, 13p, 14p, 15p, 17p, 18p, 20p 수정_ 신규 8p 08.09.18-2p, 11p, 12p, 18p, 19p, 23p 수정_ 신규 6p 08.11.20-1p, 8p, 18p, 19p 수정_ 신규 4p 08.11.26-12p 수정_ 신규 1p 08.12.01-1p, 26p~32p(페이지 추가)_ 신규 8p			

연락처  
**VISION 담당 방문수**  
 TEL: 730-0660 FAX: 730-3788