

1

A

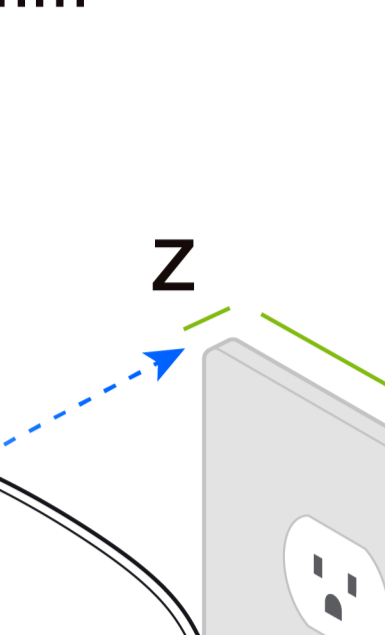

X < 75mm
Y < 120mm
Z < 6mm

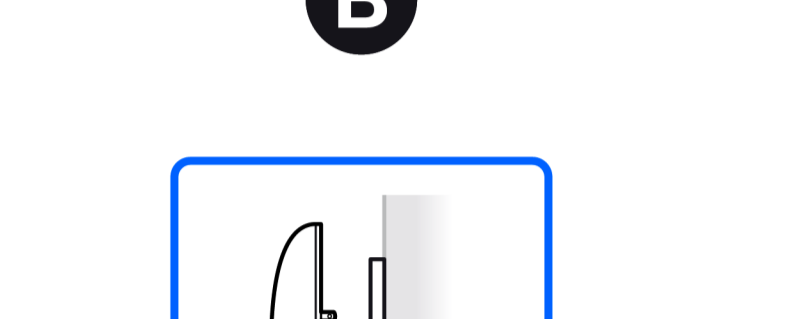

B

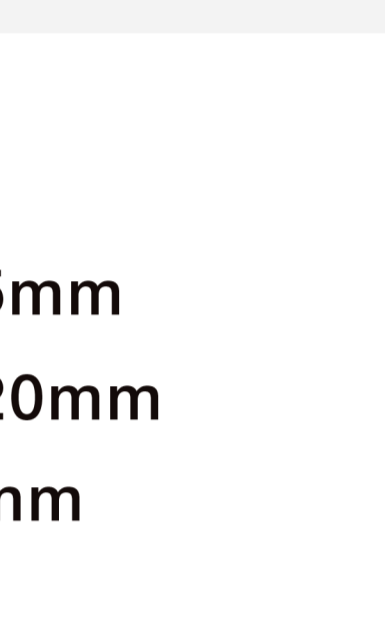

X > 75mm
Y > 120mm
Z > 6mm

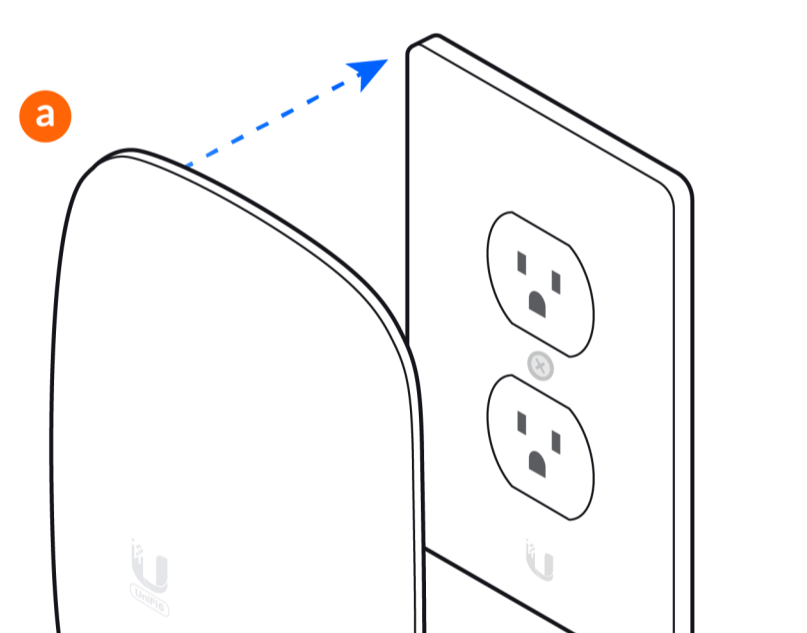
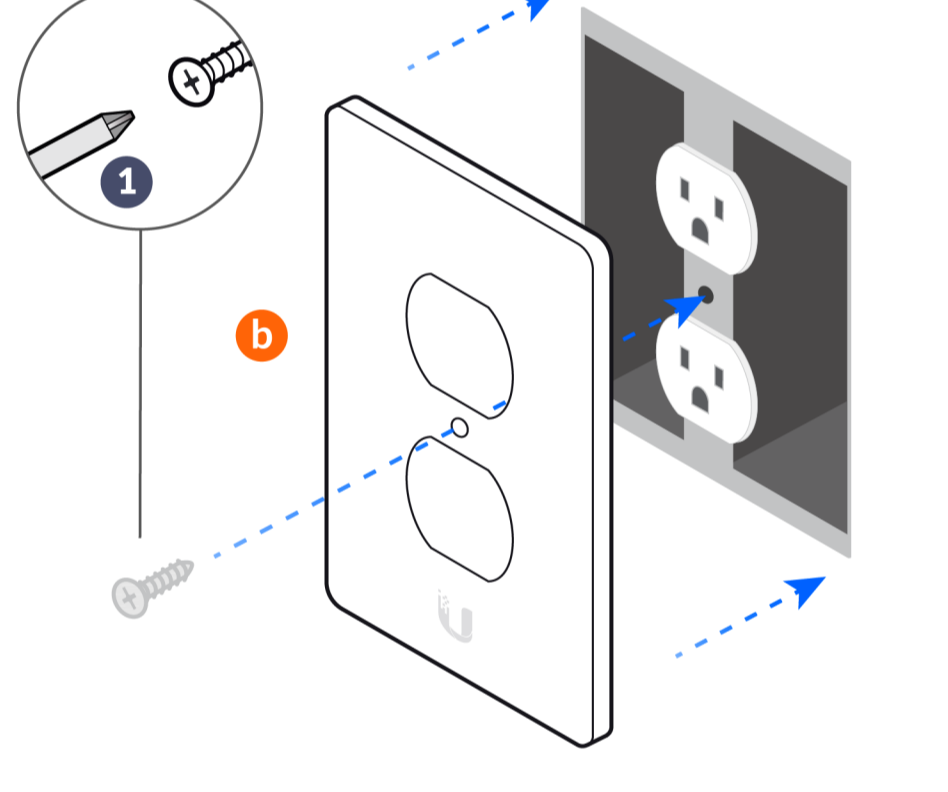
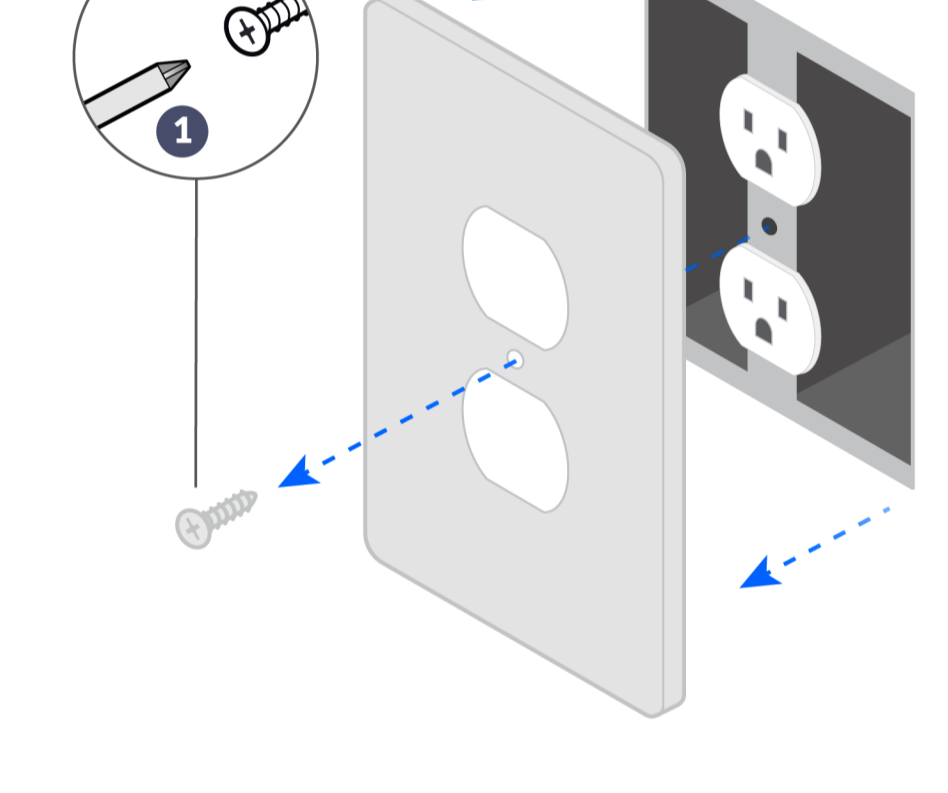

2

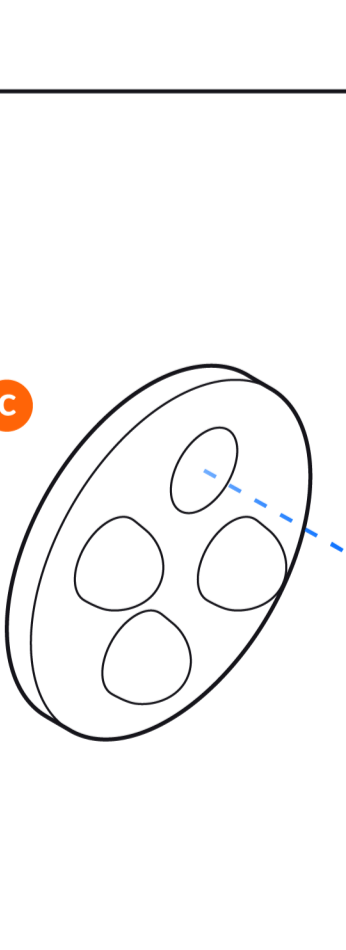
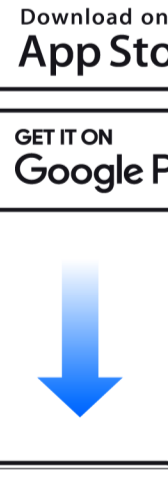

3

