



LIECTROUX

Robot Vacuum Cleaner L200



"CE" marking states that the product is compliant to European Directives
2006/95/CE Low Voltage Directive
2004/108/EC EMC Directive
It is possible to request a full copy of Declaration of compliance to the Distributor:
This product complies with the rules of RoHS Directive(2002/95/CE)
This product complies with the rules of Eup Directive(2009/1255/CE)

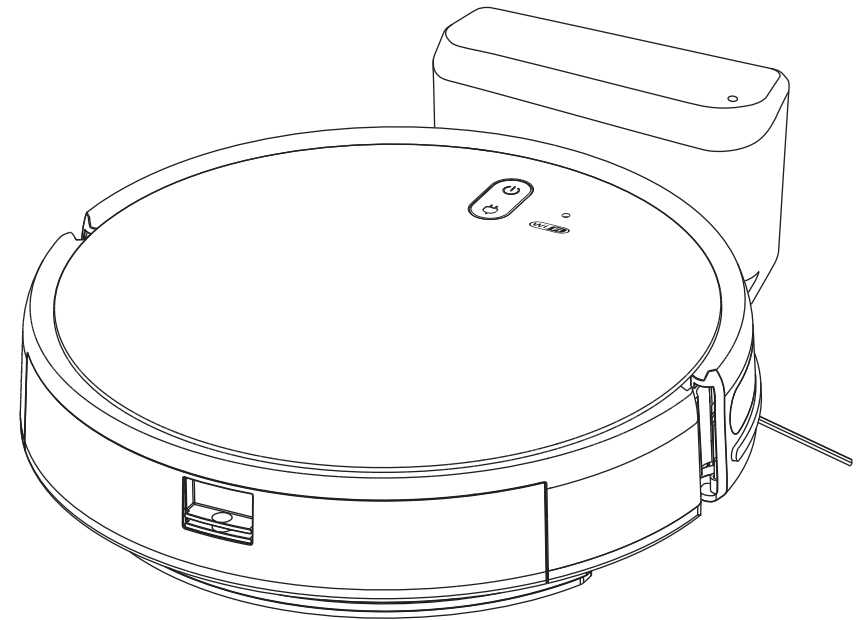

English

Robot Vacuum Cleaner Instruction Manual

Please read this manual carefully before using the product and keep it safe.

Content

1. Safety information	01
2. Packing list	02
3. Technical specification	03
4. Product introduction	04
5. Quick install Guide	06
6. Method of usage	07
* APP connection	10
7. Maintaining	17
8. Troubleshooting	21

SAFETY INFORMATION

Limitations of use

- Please keep the plastic bags away from infants and young children to avoid suffocation.
- Please do not use it outdoors (such as open balconies) or in commercial and industrial area, this product is only used for floor cleaning at room.
- Please do not use it in a suspended area without protective fences.
- Please hang up the cables on the floor of your home before use to avoid dragging the cables when the host is running.
- Please put away fragile items placed on the ground at home before use.
- Please do not use this product on uneven, non-floor surfaces.
- Please do not let children and mentally retarded use the product, and do not let young children use the product as a toy. Please prevent pets from hindering the robot's work.
- Please do not use to clean burning materials (such as burning cigarette ends, mosquito coils, etc.).
- Please do not use for cleaning sharp or hard objects (such as decoration waste, glass, nails, etc.).
- Please do not use it in the toilet, do not clean the machine with water, and use a rag to wipe the surface of the machine.
- Please use this product in accordance with the instruction manual. The user shall be responsible for the loss and injury caused by improper use, manual disassembly, or intentional damage.

Battery & Charging

- Do not burn the product even in seriously damaged, because the battery may explode by burning, and do not throw away the battery randomly.
- Do not use any third-party batteries, charging stations, adapters.
- Do not disassemble, repair or modify batteries and charging stations without permission.
- Do not place the charging station near heat sources (such as radiators).
- Do not wipe the electrode contact piece of the charging pile with wet hands or wet cloth.
- If the power cord is damaged, it must be replaced with a special cord or a special component purchased from its manufacturer or maintenance department.
- If you need to transport this product, please make sure that the host is turned off, and it is recommended to use the original box.
- If it is not used for a long time, please recharge it every 3 months to avoid battery damage due to over-discharge.
- Please cut off the power at first before removing the battery, and you need to use the correct tool to remove the battery cover screw, then open the bottom cover of the product to remove the battery.

Name and content of harmful substances in products

Component Type	Hazardous Substance					
	Lead (Pb)	Mercury (Hg)	Cadmium (Cd)	Hexavalent chromium (Cr(VI))	Polybrominated biphenyls (PBB)	Polybrominated diphenyl ether (PBDE)
Shell material	○	○	○	○	○	○
Circuit board	○	○	○	○	○	○
Electric Motor	○	○	○	○	○	○
Battery	○	○	○	○	○	○
Accessory	○	○	○	○	○	○

This form is prepared according to the provisions of SJ/T 11364.
 ○: It means that the content of this hazardous substance in all homogeneous materials of this part is below the limit requirement specified in GB/T 26572.
 ×: It means that the content of the hazardous substance in at least one homogeneous material of the part exceeds the limit requirement specified in GT/T 26572.



PACKING LIST

The illustrations of the product, accessories, user interface, etc. in the manual are schematic diagrams for reference only. Due to product updates and upgrades, the actual product may be different from the schematic diagram.

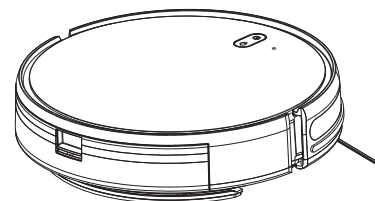

Robot Vacuum *1
(The mop plate has been installed)

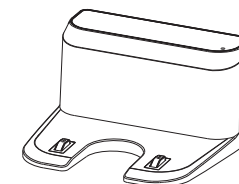

Charging Base*1

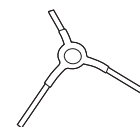

Side Brushes*4
[L(Left)side brushes *2,
R(Right) side brushes*2]

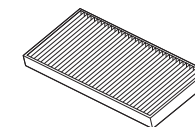

Filter*2
(1 piece in dust box,
1 piece in package)

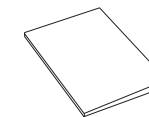

Manual*1



Mop Pad*2
(1 piece on the mop,
1 piece in package)

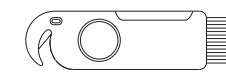

Cleaning Kit*1

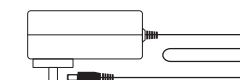

Adapter*1

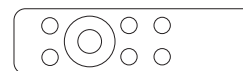

Remote Control*1

TECHNICAL SPECIFICATION

Robot vacuum

Product name	Robot vacuum
Product model	L200
Product dimensions	300*300*75mm
Input voltage	19V $\overline{\text{---}}$ 0.6A
operating voltage	14.4V
Rated power	28W
Battery type	Lithium battery
Battery capacity	2600mAh

Charging base

Input	19V $\overline{\text{---}}$ 0.6A
Output	19V $\overline{\text{---}}$ 0.6A
Rated power	24W
Product dimensions	158*137*84mm

PRODUCT INTRODUCTION

1. About the host

-  Power on/off , Cleaning, Pause
 * Start cleaning/Pause cleaning
 * press and hold 3s, Power on/off

-  Recharging/Pause
 * Start charging/Stop charging

-  Definition of indicatorlight :
 * Blue: Work properly
 * Red: Abnormal warning or low battery
 * Blue flashing: Recharging

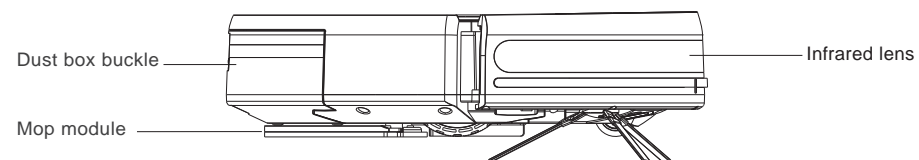
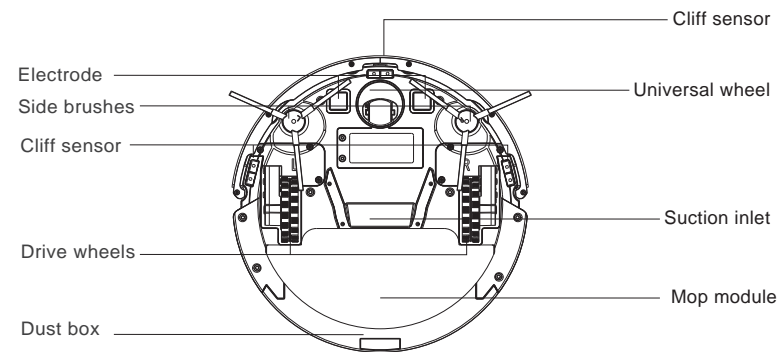
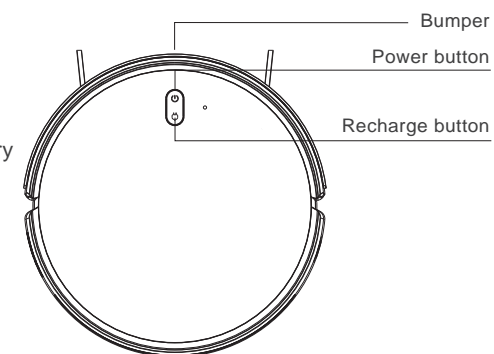

2. Charging base

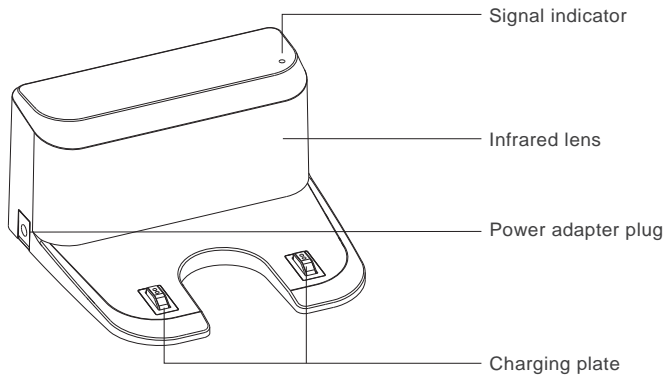

3. Remote control

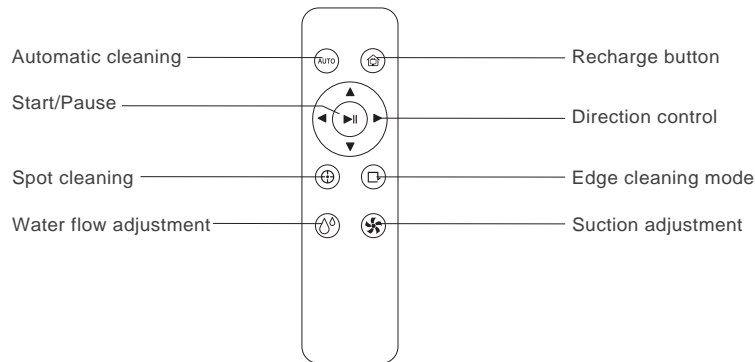

Quick Install Guide

1. Please remove the protective foams from the main unit and install the side brush correctly.

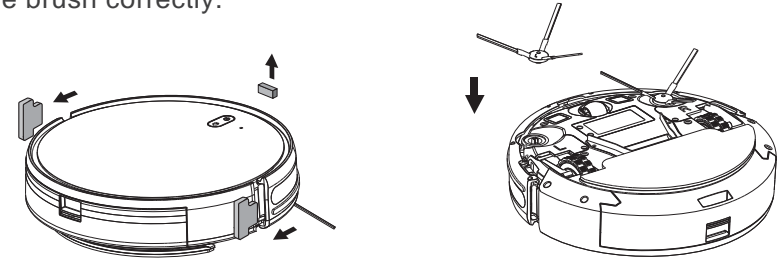

2. Place the charging base on a flat ground against the wall. Do not place any objects within 0.5m by sides and 1.5m in front of the charging dock.

Tips: Please tie the extra wires together

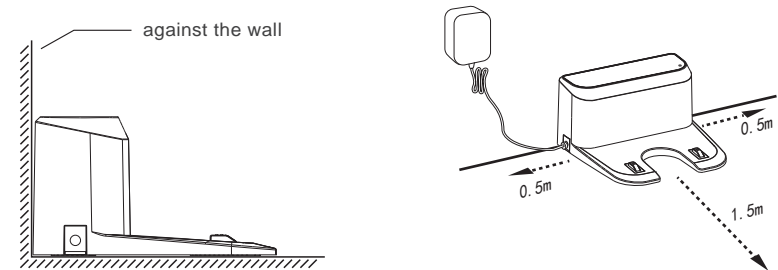

3. Please full charge the device before use.

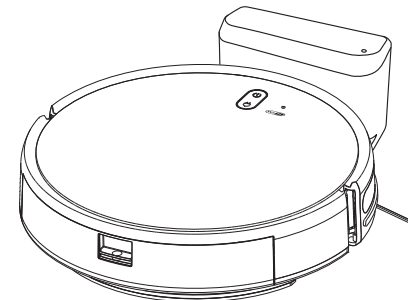

Method Of Usage

1. Before using Robot, pick up objects like clothing, loose papers, pull cords for blinds or curtains, power cords, and any fragile objects. Please also set up protective facilities at the entrance of the stairs, elevator entrance, kitchen and bathroom and other rooms to avoid damage device.

Note: Do not use the robot to clean up standing water.

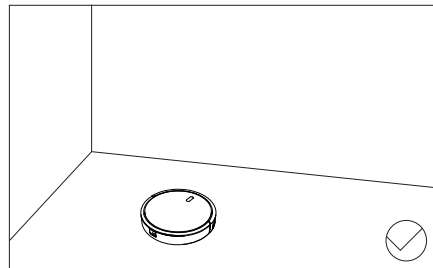
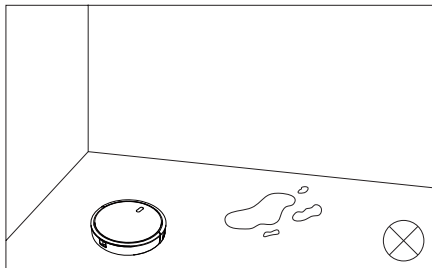
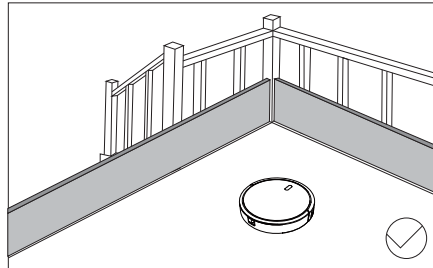
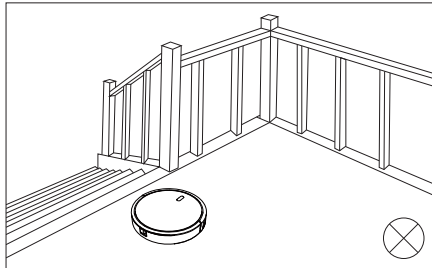
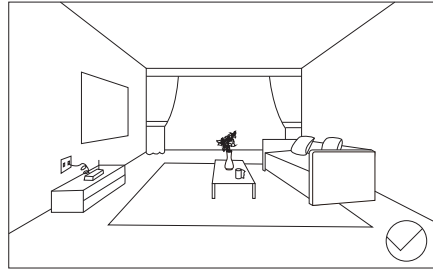
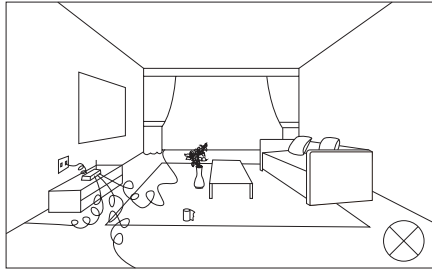

2、 Use of mopping function

- 2.1. Press the dust box buckle and pull the dust box, and remove the water tank from device.

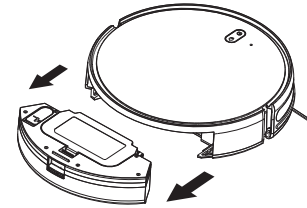

- 2.2. Please inject amounts of water to the water tank, closing the water tank cover tightly and install the device in the opposite direction.

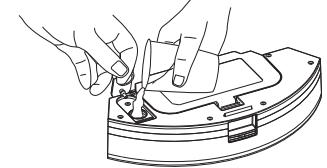

- 2.3. Install the water tank which is injected with water to robot vacuum.

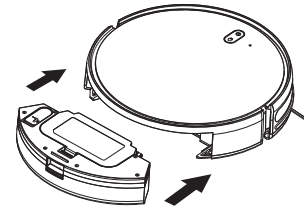

- 2.4. Take out a piece of mop, at first put the raised part of the mop board to the pocket of the mop, and then press the mop onto the mop board to be symmetrical with its outer contour.

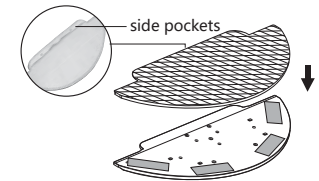

- 2.5. Make the back of mop board face to the bottom of the robot vacuum, and press the fixation down against the hole on the mop module, till hear the sound "ka" that means install successfully. Gently flip the device over, place it on the floor and turn on the power, short press "U" or press the "AUTO" button to start the mopping function. (When the mopping board is installed, the device will automatically be in mopping mode after it is turned on.) Please do not use the mopping function on carpets.

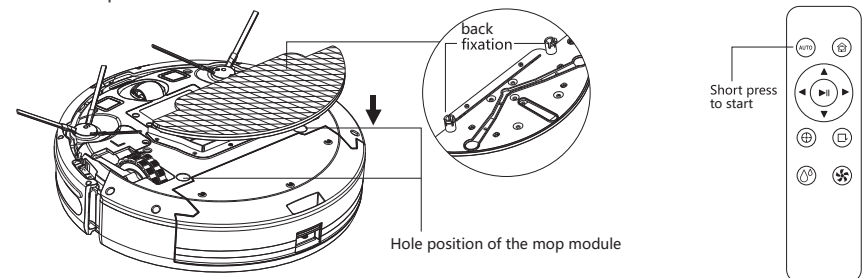

3、 Use of cleaning function

3.1. The mop module be installed when the robot vacuum leaves factory, Please remove the mop module before using only the vacuum function. Use your finger to clasp the middle of the mop module and remove the mop module. Store the mop module in a place out of reach of children, take it out and install it on the device when the mopping function need to be used.

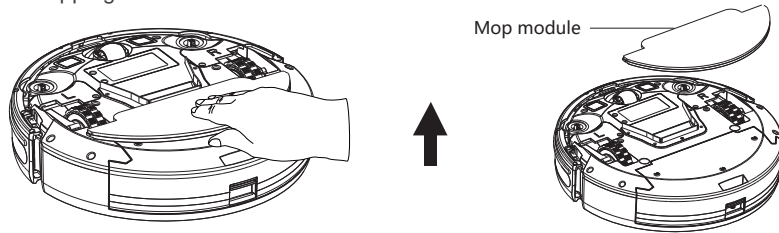

3.2. Take out the side brushes, install them in correct position corresponding "L/R", And press down vertically once hear the sound "Da" that means install successfully.

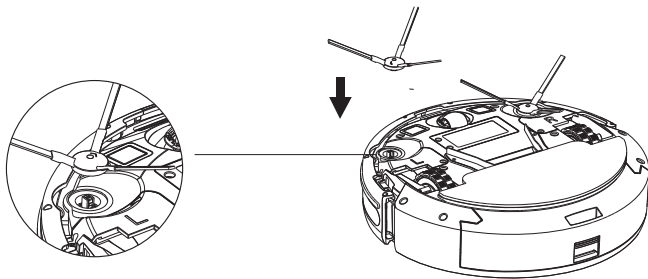

3.3. Turn the device upside down on the floor after the side brushes installed, and short pressthe "⏻" or the press the "AUTO" button to start the cleaning function.

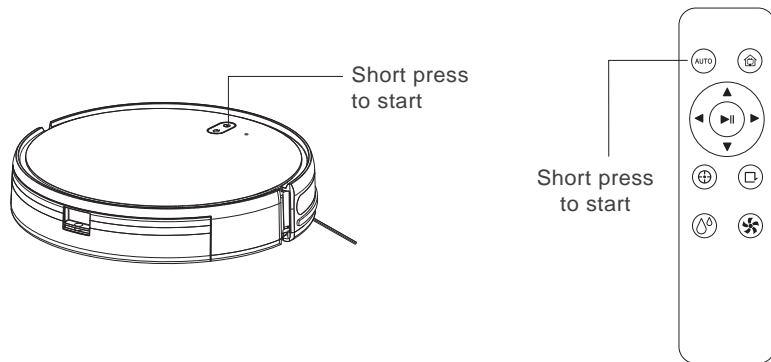

APP Connection

4. APP download, installation and registration.



4.1. Search the "Tuya" app in the APP store or scan the QR code above to download and install it.



4.2. After registration and login, click the "+" sign in the upper right corner, or click the "Add Device" .

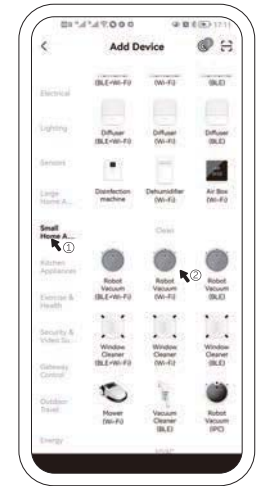

4.3. Select "Small Household A..." -"Robot Vacuum(Wi_Fi)"



4.4. Enter the WiFi password to login. Click the "next".



4.5. Press and hold the "⏻" key and "🌀" key at the same time for at least 3 seconds, then hear a beep, and the WiFi indicator turns to flash, Then click the "next".



A4.6 /B4.6. There are two connection modes, "AP Mode" and "EZ Mode". (step A4.6): Please select "AP Mode"; (step B4.6): Please select "EZ Mode". (step B4.7, Please jump to page 12.)



A4.7. Click "Go to Connect" to enter the WiFi selection interface.



A4.8. Please select the WiFi signal sent by the equipment. Named after "SmartLife-XXXX". Then return to the application connection.

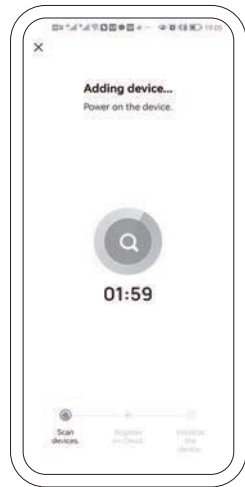

A4.9. When the device is connected to the Internet, please pay attention to the tips in the interface.

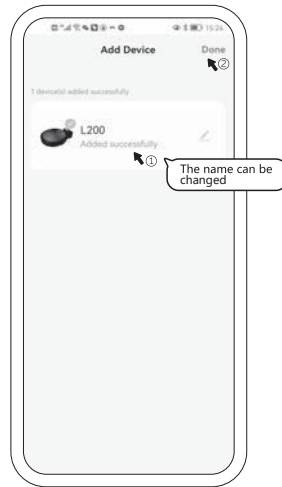

A4.10. When prompted "add successfully", the device icon will be displayed, and the name can be changed according to its own preferences, and click "Done".

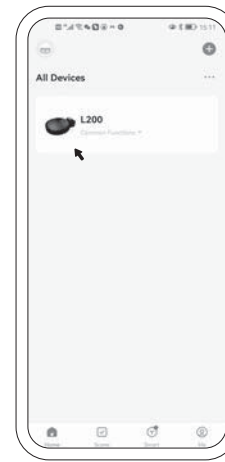

A4.11. After the completion of the add up, the device icon will be displayed on the front page of APP. Click to enter the control interface.

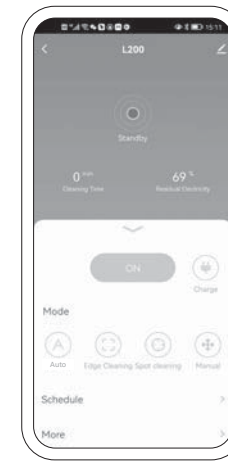

A4.12. Click "ON" to default to work in "auto" mode, or select the appropriate mode and operation function according to the actual situation.



B4.7. After clicking "EZ mode", the application will search for smart devices in the same WiFi environment by itself. Meanwhile pay attention to the tips.

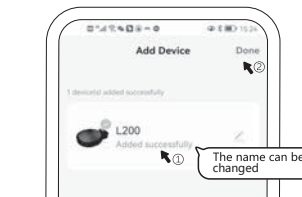

B4.8. When prompted "add successfully", the device icon will be displayed, and the name can be changed according to its own preferences, and click "Done".

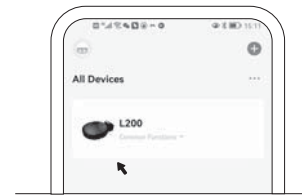

B4.9. After the completion of the add up, the device icon will be displayed on the front page of APP. Click to enter the control interface.

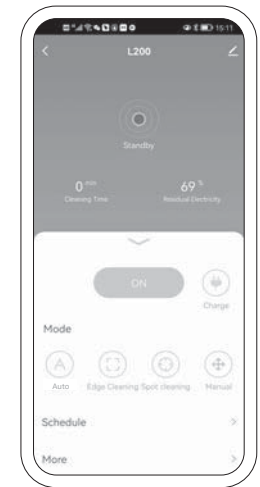

B4.10. Click "ON" to default to work in "auto" mode, or select the appropriate mode and operation function according to the actual situation.

5. Start/Pause(After the robot vacuum power on, short press the “⏻” button on the device to start or pause the device, or use App or press the “▶||” button by remote control to start or pause the device.)

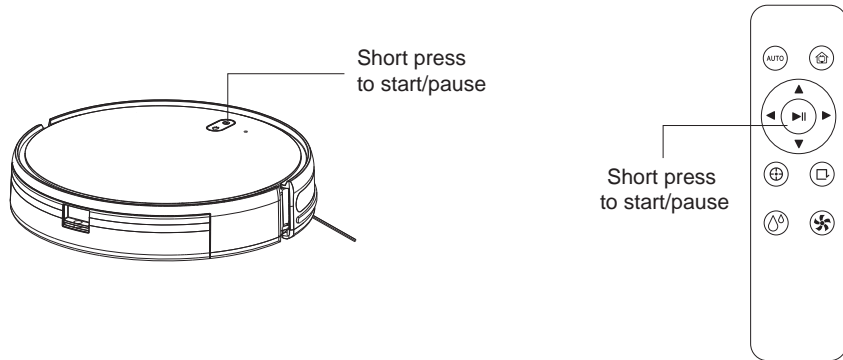

6. Recharge(If robot with low power, it will automatically return to charge . when it's at sleeping or working mode. It can also return to charge by press “🏠”/“🏠” or be controlled by remote control and App.)

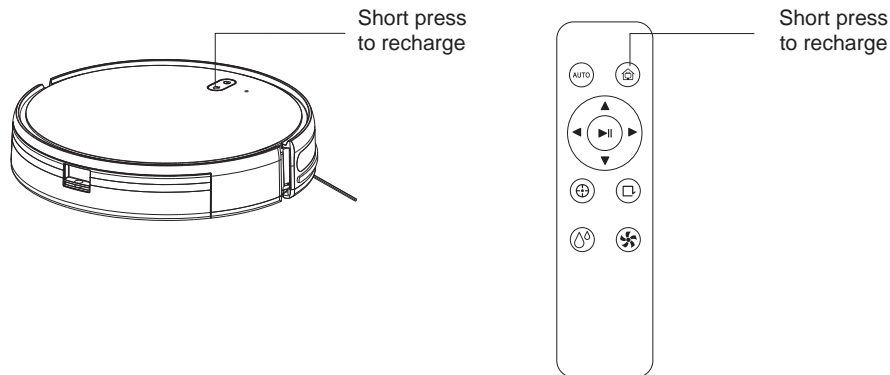

7. Working modes

- 7.1. Automatic cleaning (after startup, the vacuum cleaner will clean the whole house in a bow shape. After cleaning, the equipment will automatically return to the charging stand, which is also the default mode.)

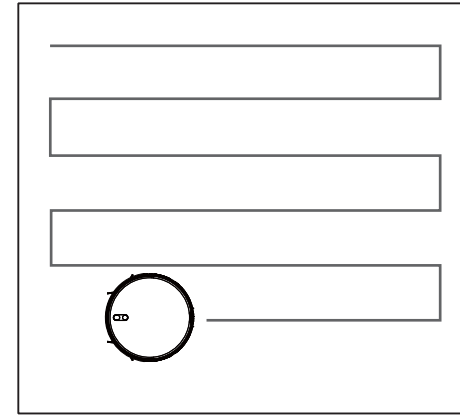

- 7.2. Spot cleaning(Press the “⊕” button on the remote control, clean in a spiral clockwise from the inside to the outside. After spiraling with the maximum radius of 24.6 inches, clean in a spiral from the outside to the inside, and finally return to the starting position and finish the cleaning. It's also support using the direction button on the App to control the robot vacuum to the location that need to be clean)

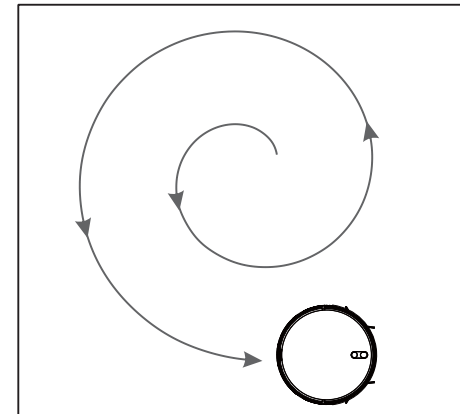

7.3. Edge Cleaning(The robot vacuum cleans the periphery of the indoor fixed objects (such as walls, table corners, etc.), and returns to the charging dock after working along the edges. Also could press “□” on the remote controller or App to quickly start edge cleaning mode.)

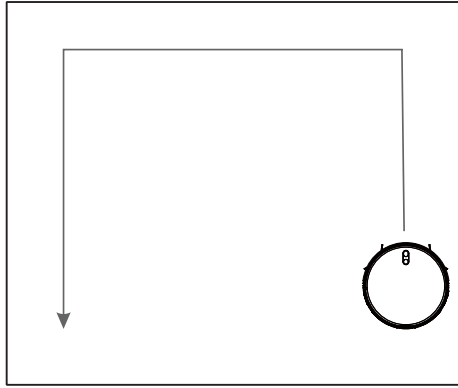

7.4. Appointment timing function (The cleaning time can be set on the App and support 7x24 hours appointment. The device will automatic cleaning your house in your appointment time, and finally return to the charging dock for charging when cleaning is finished.)

7.5. Quiet mode (Turn on quiet mode, the device will not play voice, you can use the APP to turn on or turn off quiet mode.)

7.6. Manual mode(After the manual mode is turned on in the APP, the device can be controlled by the arrow key in the interface of the APP, or press the “▲▼▶◀”button on remote control to control the device direction)

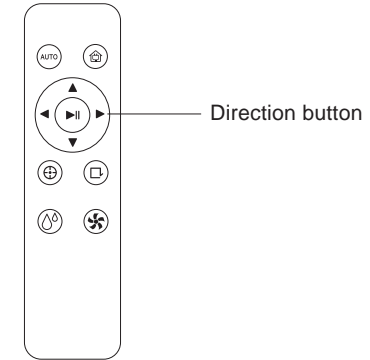

8. Water adjustment(Using the APP or press the “⊕” on the remote control can choose high-grade, mid-grade, low-grade mode, the default is mid-grade mode.)

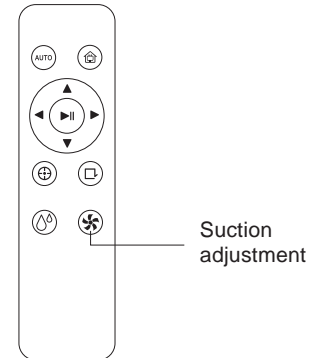
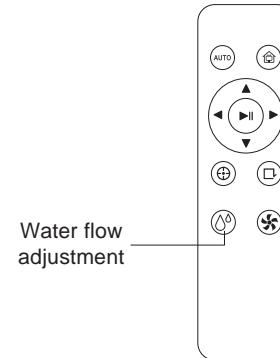

9. Suction adjustment(The suction level such as strong, normal and quiet modes could be chosen by APP or press the “🌀” on the remote control, the default is normal mode.)

Maintaining

1. Suction inlet cleaning(Once a week is recommended)
Gently turn the device over and wipe the suction port with a clean dry cloth.

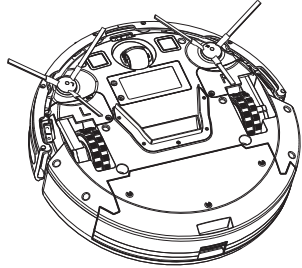

2. Side brushes cleaning (Once a week is recommended)

- 2.1. Gently turn the device over and pull out the side brushes vertically.

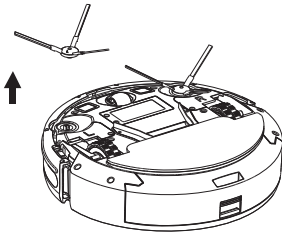

- 2.2. Reinstall it after cleaning the entanglement and dirt.

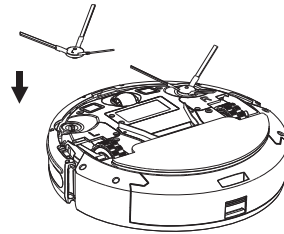

- * Please confirm the correct position corresponding to the left (L) and right (R) brush installation.
- * Side brushes are consumables, and it is recommended to replace them every 3 months to ensure the cleaning effect.
- * Please purchase on the official website

3. Water tank, dust box and filter cleaning (Once a week is recommended)

- 3.1. Press the water tank /dust box buckle and pull out the water tank /dust box.

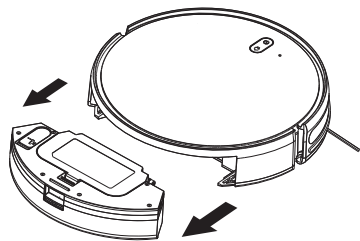

- 3.2. Press the filter buckle and open the filter cover to dump out the trash in the dust box.

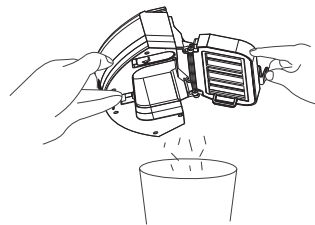

- 3.3. Remove the filter gauze, HEPA filter and sponge, wash the filter gauze with water, and use cleaning tools to clean up the rubbish mixed in HEPA. HEPA is not washable, sponges are washable. Then clean the dust box, wait for the sponge and filter gauze to dry before putting it back for use.

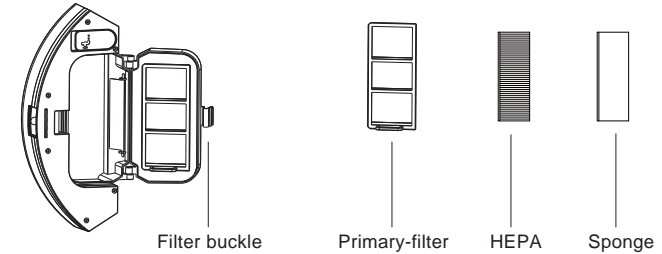

- * HEPA filter and sponge are consumables, it is recommended to replace a set every 3 months, please buy it on the official website.

- 3.4. Make sure there is water in the water tank before using the mopping function. Press the button on the water tank/dust box and pull the water tank/dust box back out. Open the water tank cover, inject amount of water and fasten the water tank cover. Reinstall the 2-in-1 dust box in the opposite direction from which it was removed.



- *Please do not add detergent to the water tank and do not wash or soak the water tank.

4. Mop board cleaning (Once a week is recommended)

4.1. Remove the mop board vertically from the device.

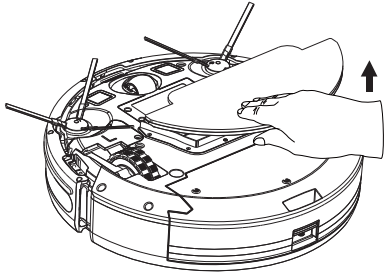

4.2. Fasten a new (clean) mop to the mop plate.

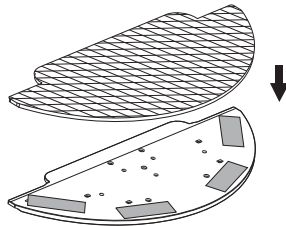

4.3. Install the mop board to the device.

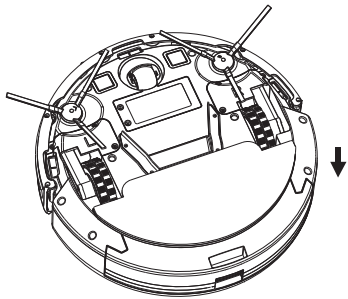

Notice:

- * Please do not use the mopping function on carpets.
- * In order to clean well, please clean the mop in time.
- * Replace the mop according to the actual usage, so as to maintain the machine in normal effect
- * Mop as consumer product, please purchase it in official website.

5. Equipment signal area maintenance (Cleaning it once a month recommended)

5.1. Maintaining the front anti-collision sensor with a soft dry cloth.

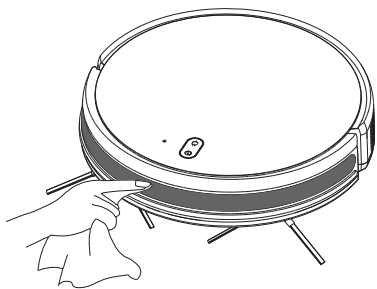

5.2. Maintaining the TOF sensor with a soft dry cloth.

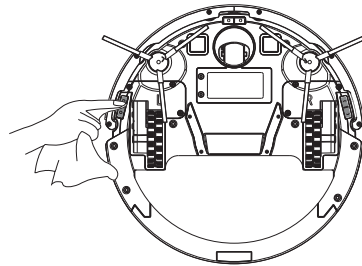

5.3. Clean the charging contact area with a soft dry cloth

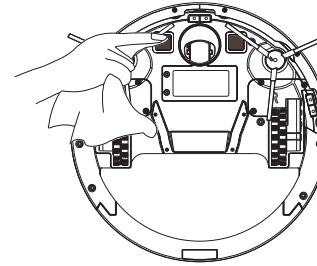

5.4. Clean the signal transmission area, maintenance with a soft dry cloth.

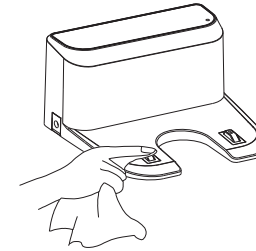

6. Battery maintenance

- 6.1. Equipped with a built-in rechargeable lithium battery pack, in order to maintain battery performance, keeping the robot in charging status, which is good for longer life of battery and does not over-loss electricity.
- 6.2. If it is not in use for a long time, please full charge and turn off to be stored.
- 6.3. Charging at least every 3 months, avoiding the battery to cause over hang damage.
- 6.4. Must use original power adapter when charging.
- 6.5. Lithium batteries is full charged randomly for ready to use. No need to be charged with whole 12 hours.

7. Firmware upgrade

The firmware upgrade by mobile app, Entering the firmware upgrade function, upgraded according to the prompt step by step after detecting the new firmware, the power should be more than 50%, it is recommended to place the device on the charging station to upgrade.

TROUBLESHOOTING

Troubleshooting

The problem	Solution
Unable to boot	<ul style="list-style-type: none">*When the battery is low, place the device on the charging base, align it with the contact point, and the device will start up automatically.*If the ambient temperature is lower than 0°C, use it in an environment of 0 to 40°C.*Check whether the plug of the device power adapter is properly connected and the power supply of the socket is normal.
Unable to charge	<ul style="list-style-type: none">* Bad contact, please clean the dirt on the charging contact point, or unplug the side brush.* The device is too far away from the charging base. Please try placing the main engine near the charging base.
Unable to back to recharge	Shut down and restart.
Abnormal running	The main brush, side brush or wheel may be entangled with foreign objects, please clean it after stopping the machine.
Abnormal noise when cleaning	The dust box is full, please clean the dust box.
Decreased cleaning ability or dust drop	<ul style="list-style-type: none">*The filter is clogged, please clean or replace it.*The roller brush is entangled by foreign objects, please clean the roller brush.
Unable to connect to WIFI	<ul style="list-style-type: none">*The WIFI signal is not good, please make sure that the device is in a good WIFI (2.4G frequency band, does not support 5G) signal coverage area.*Please reset WIFI and download the latest mobile APP to try to connect again.*Check if your password is entered incorrectly.
Scheduled cleaning failed	If the battery is insufficient, the scheduled cleaning will be started only when the remaining battery is $\geq 15\%$.