

TECHNOZOM

Techno GO

User Manual

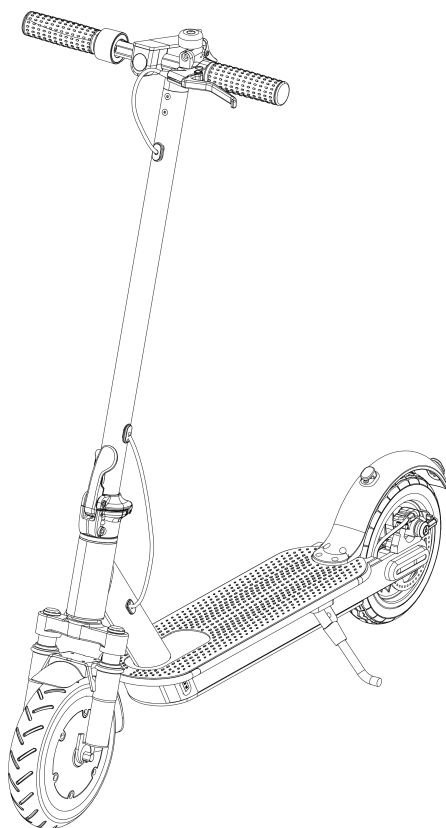

Please read this manual before using this product.
Made In P.R.C

Content

Package Contents	01
Product Overview.....	02
Assembly and Configuration	03
Charging scooter /Unfold the scooter	04
How to drive.....	05
Safety Instruction.....	06 ~09
Daily Mantennace and Repairment.....	10
Specification.....	11

Package contents

Included in the package

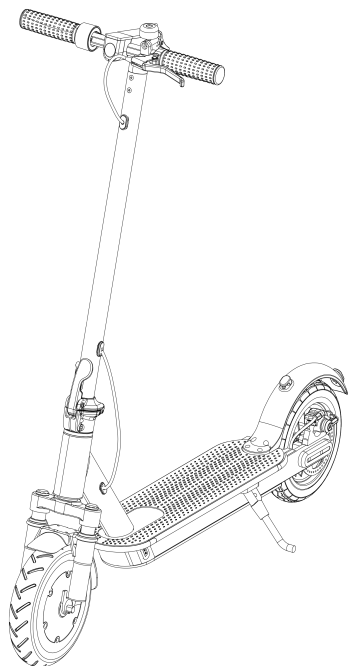

Scooter

Accessories

User Manual

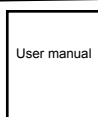

Tool kit



Charging adapter

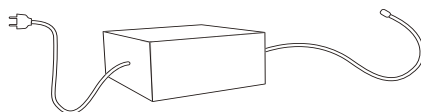

Product overview

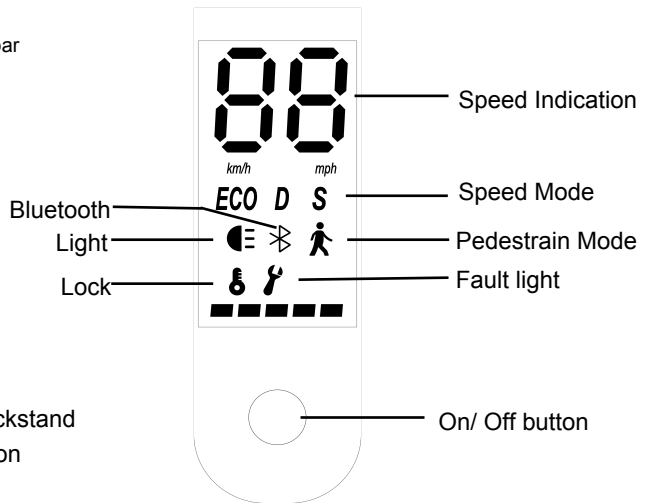
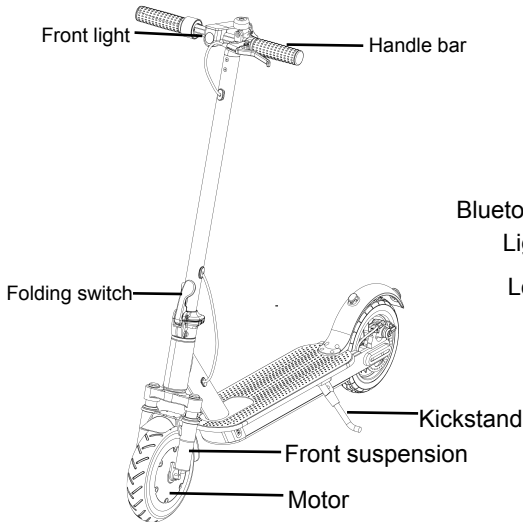

Display overview

Functions:

1. Open the scooter by pressing the On/Off button over 3 seconds
2. Once scooter turned on, press the On/Off button once to switch the light of the scooter
3. Once scooter turned on, press the On/Off button twice to switch the speed mode
There are four speed gear for this scooter: Pedestrian Mode: 6km/h (the front and rear light will be shining) ; ECO Mode: 15km/h; D Mode: 20km/h; S Mode: 25km/h
4. If your scooter is Techno GO PLUS, you can turn on and off the Ambient light by pressing the On /Off button three times
5. You can control the scooter with APP (MiniRobot) after connecting it with bluetooth

The QR of the APP



Assembly and configuration

1) Fix the steering rod and open the kickstand

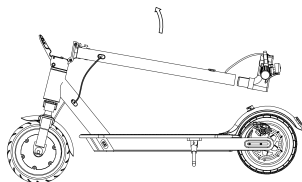

2) Lift the steering rod and lock it

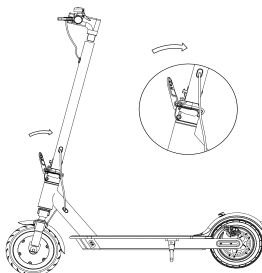

3) Connecting the cables from the handle bar and steering rod

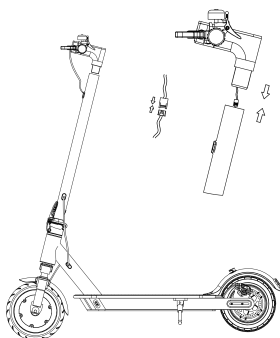

4) Use the wrench in the packing toolkit to tighten the screws on the handle bar

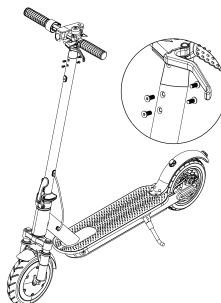

5) Testing the power button after finishing assembling

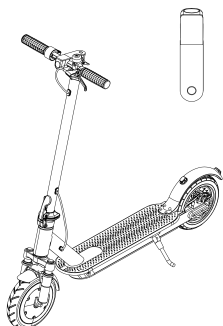

Charging Scooter

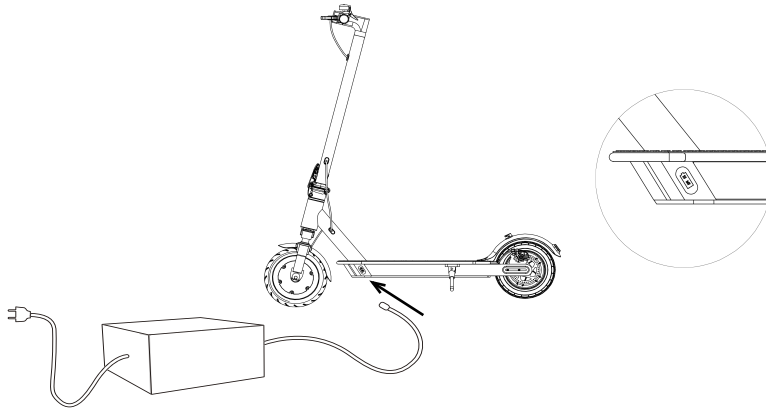

Warning: Only used the original charger

Unfold the scooter

1) Push the switch on the folding switch upward



2) Open the folding switch



3) Make the steering rod fold down

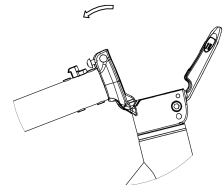

4) Lock the handle bar into the rear fender

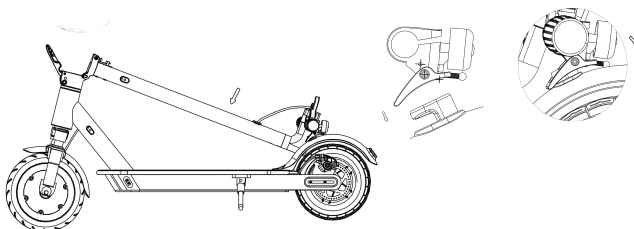

How to drive

Please wear a helmet and knee pads to protect against injury in case of a fall.

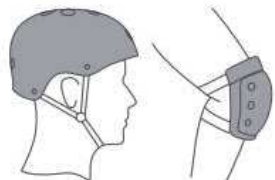

Please check the battery indicator to be sure it is fully charged. Stand on pedal with one leg, hit the ground with the other leg.



When the speed get 5km/h press the accelerator

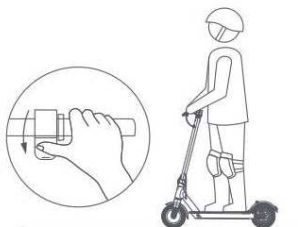

Braking the scooter by hold the braking lever

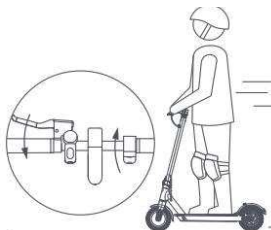

Lean your body to the steering direction as you turn, and slowly turn the handle bar.

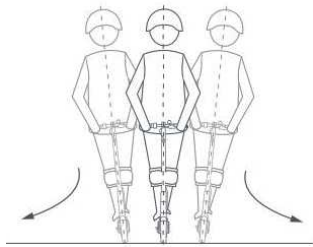

Safety instruction

Keep speed between 6-15 km/h on the bumpy surfaces



Look out for doors, elevators and other over head obstacles.

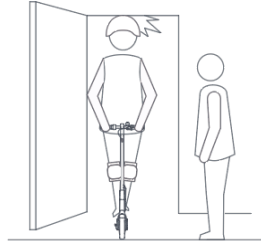

Do not accelerate when you go down a hill



Don't press the throttle while walking with scooter

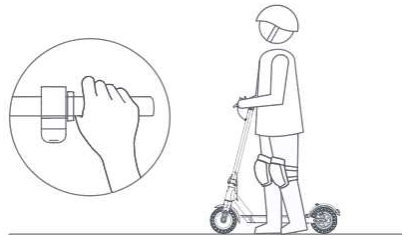

As you are riding be aware of obstacles like curbs, speed bumps, and natural items like rocks.

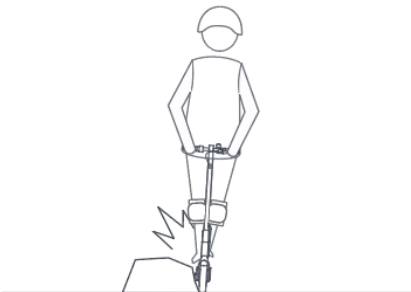

Do not hang items on handle bar as this could impact your balance.



Always keep both feet on scooter when riding



 **WARNING: Avoid all safety risks listed on this page.**

Do not ride in the rain
Wet and rainy conditions are slippery and hazardous.



Do not drive in lanes reserved for car traffic or transit in residential areas where vehicles and pedestrians can circulate

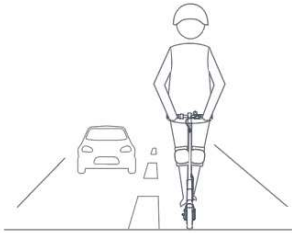

Do not turn the handlebar sharply when driving at high speed

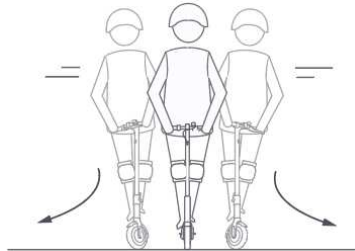

Do not pass through puddles with a water level greater than 2cm



Do not travel on the scooter with other people including children

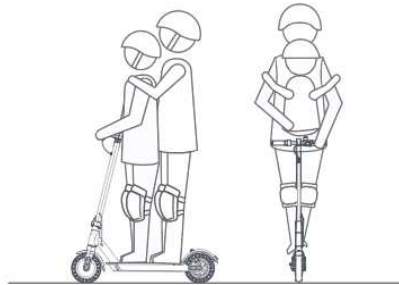

Do not place your feet on the mudguard



WARNING: Avoid all safety risks listed on this page.

Never touch disc brake, located on the back wheel.

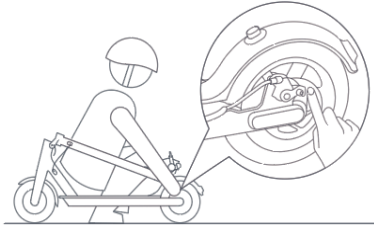

For safety, keep both hands on the handlebars at all times.



Do not try to climb or descend stairs and overcome obstacles by jumping

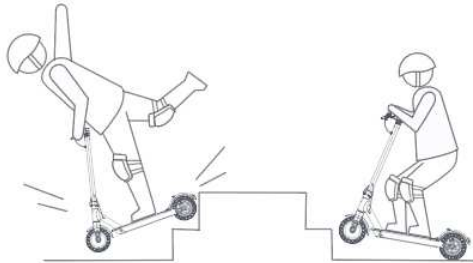

Safety Instruction

Helmets and protective gear must be worn throughout the ride

It is forbidden to ride into the residential area with mixed flow of motor vehicles and people and vehicles, and to drive in the water over 2cm.No more than one person driving at the same time or carrying children.

It is forbidden to ride up and down stairs or escalators. When encountering speed bumps, elevator thresholds, potholes, etc., please keep driving in low grade (3-10kmh/2-6mph) or stop using.

The scooter is a sport and not a vehicle, but once you drive it into a public area, it will also have the attributes of a vehicle. Therefore, there are all possible safety risks of transportation. Driving strictly in accordance with the instructions in this manual will protect the safety of you and others to the greatest extent.

At the same time, you need to understand that once you drive in a public lane or other public places, even if you completely follow this manual, you may face the risk of improper driving operation caused by other people or vehicles. Just as walking or cycling can be harmed by other means of transportation.

As with all vehicles, the faster you drive, the longer it takes to brake, and slamming on some slick ground can cause the wheels to slip and lose their balance and fall. Therefore, it is very important to be vigilant while driving, keep a proper speed and keep a reasonable distance from others and vehicles. Remain alert and drive at a low speed before entering unfamiliar terrain.

Please respect the right of way when driving. Avoid frightening pedestrians, especially children. When passing behind pedestrians, please remind pedestrians and slow down when passing. Try to pass from the left side of pedestrians as far as possible (applicable to countries and regions where vehicles drive on the right side, keep on the right side and slow down when facing pedestrians).

In China and other countries and regions where there are currently no national standards and regulations related to electric scooters, please be sure to strictly comply with the safety requirements for drivers in this manual. The company shall not be directly or severally liable for any loss of property, personal injury, legal dispute or any other adverse event causing conflict of interest arising out of any violation of this manual.

Do not lend your car to someone who will not use it to avoid injury. Please be responsible for the safety of your friend. Please teach your friend how to use the car and tell him to wear safety devices. Please conduct a basic inspection of the car before each drive. If you find any abnormal conditions, such as obvious loose parts, significantly reduced battery life or abnormal sound of excessively worn parts, please stop using immediately and do not drive forcibly. Please contact our customer service staff for product maintenance.

Daily Maintenance and Repair

Cleaning and storage

If the vehicle surface stains, use a soft cloth dipped in a small amount of water to wipe. If appear hard clean besmirch, can use toothpaste daub soft cloth is wiped first, clean with wet cloth next

Remarks: Do not use alcohol, gasoline, kerosene or other corrosive, volatile chemical solvents for cleaning, otherwise, it will seriously damage the appearance and internal structure of the vehicle body.

Do not use pressure water gun for flushing. Please make sure the machine is shut down. In addition, the charging wire has been removed and the rubber cover of the charging port has been tightened, otherwise there may be electric shock or serious failure due to internal water ingress

As far as possible in the indoor dry, cool storage, as far as possible to avoid a long time in the outdoor storage. Exposure to the sun, heat and cold outdoors can accelerate the appearance and tire aging, reducing the life of the battery pack

Battery Maintenance

Please don't place the battery in more than 50 degrees of high temperature or low temperature below 20 degrees Celsius environment (for example, do not keep the battery in the summer sun car), it is forbidden to battery into the fire, otherwise may cause the battery failure, overheating, or even a fire risk, battery maintenance note please see other nameplate located in the body at the bottom of the battery. Avoid completely running out of power to recharge, as far as possible with the charge with use, this can greatly extend the service life of the battery. In addition, when used at room temperature, the battery pack can give play to higher range and performance. Battery life drops when used in temperatures below zero degrees Celsius. Typically, in an environment of zero degrees Celsius or less, the range may be half or less than at room temperature. The battery's range is restored when the temperature rises.

Remarks: Fully charged batteries run out of power after about 20-90 days of standby, and uncharged batteries run out after 20-50 days of standby. If it is not charged in time, the battery may be damaged by excessive discharge. This damage is not recoverable. The damage caused by not charging for a long time will not be recharged and will not be covered by the free warranty. (note: non-professionals are not allowed to disassemble the battery pack at will, or it may cause serious safety accidents due to electric shock or short circuit)

Specification

Performance Index	Item	Comments
Dimensions	Fold Size (mm)	1100x430x1150
	Unfold Size (mm)	1100x430x515
	Canton Size (mm)	1125x160x550
Weight	Max Load (kg)	120
	Scooter Weight (kg)	13.5
Riding Requirements	Minimum Age	16-50
	Minimum Height (cm)	130-180
Main Parameter	Max Speed (km/h)	25-30km/h
	Range (km)	22-25
	Traversable Terrain	Asphalt/Flat pavement; Obstacle \leq 1cm, Gap \leq 1cm
	Waterproof Grade	IPX4
Battery	Norminal Voltage (V)	36
	Charging Input Voltage (V)	42
	Battery Capacity (Ah)	7.8
	Smart BMS	Over-heating; Overcharge; Low voltage protection
Motor	Motor Output Rating (W)	350W
Charge	Rated Input Voltage (V)	100-240
	Rated Output Voltage (V)	42
	Rated Current (A)	1.5
	Charging Time (H)	4

Range: When the electric scooter is full charged, 70kg load, 25 degrees Celsius, flat road without wind environment, in the energy-saving mode to keep at 15km/h even speed conditions measured, the actual range due to load/temperature/wind speed/road and operating habits and other factors to be different

