

Medical care PHANTOM

Bodyfriend PHANTOM MEDICAL CARE User Manual

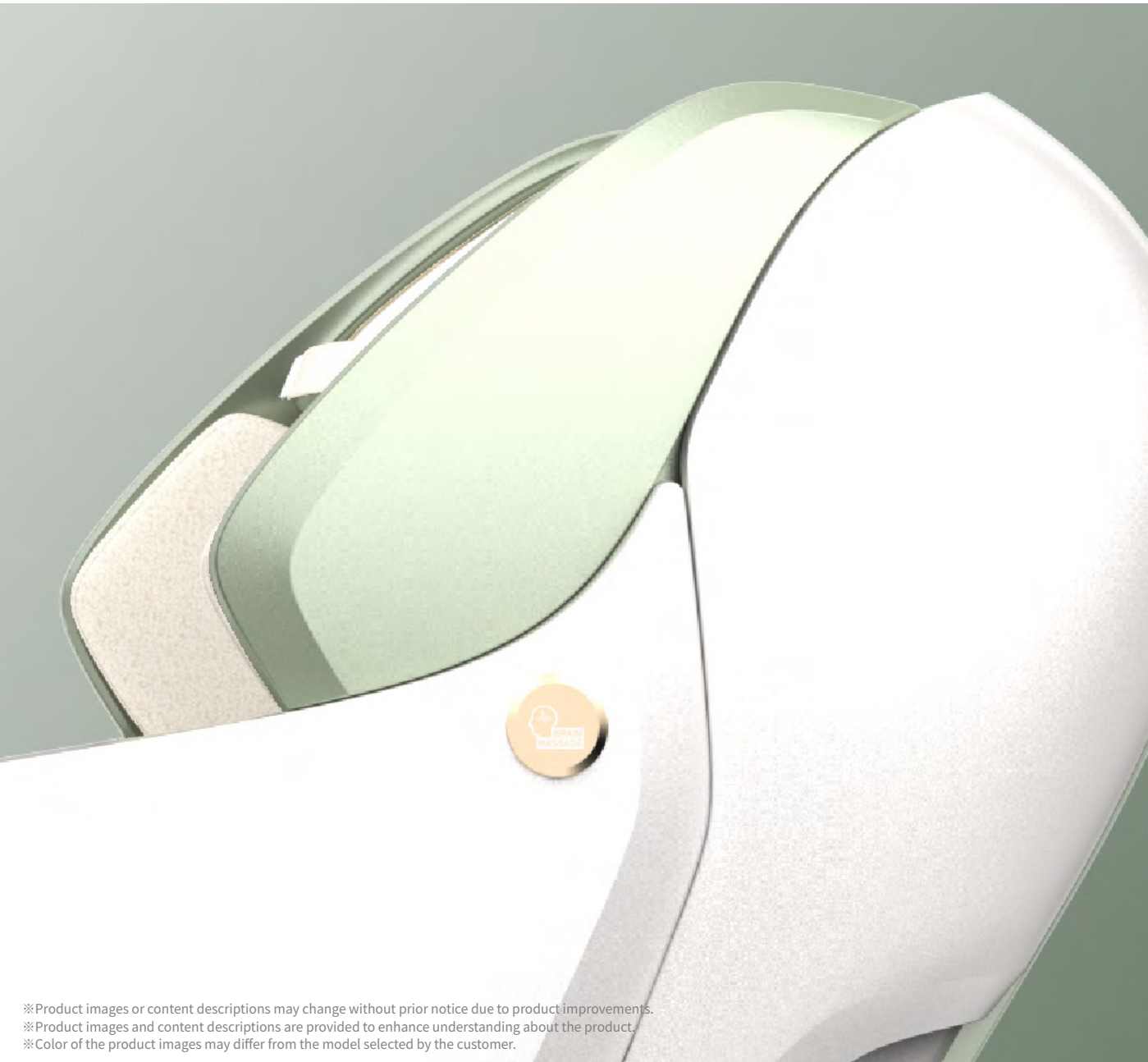

※Product images or content descriptions may change without prior notice due to product improvements.
※Product images and content descriptions are provided to enhance understanding about the product.
※Color of the product images may differ from the model selected by the customer.

Introduction

Thank you for purchasing BODYFRIEND Massage Chair [PHANTOM MEDICAL CARE].

Before using our product, please read through the safety precautions and operation instructions carefully. We kindly ask users to understand that there may be slight differences in image and content descriptions presented throughout this manual due to product quality improvements. Thank you.

Product Features



Medical Mode



Brain Massage



Mental Massage



PEMF Massage



Airbag Massage



5 Level XD Massage



Thigh-Stimulation
Massage



Thermal
Massage



Auto Slide



Auto Body Scanning



Pocket Airbag
Auto Leg Adjust



3 STEP Magnetic
Acupressure Sole
Rolling Massage



Magnetic Hand
Acupressure



Magnetic Sole
Acupressure



Anti-trap Sensor

PHANTOM MEDICAL CARE not only provides value beyond rest and healing, but also has a treatment effect on relieving minor muscle pain.

It can improve the quality of life in various aspects; 1) Minor muscle pain relief, and 2) psychological reduction of stress.

PHANTOM MEDICAL CARE is equipped with a PEMF electromagnetic generator that moves along the spinal line and stimulates adjacent muscles to effectively relieve minor muscle pain.

Table of Contents

Before Use	Introduction Product Features	02
	Important Safety Instructions	04
	Components and Descriptions	13
	Transporting Installing	14
	Installation	15
<hr/>		
Controller Descriptions	Controller Descriptions	19
	How to use	21
	Controller Function Descriptions	22
<hr/>		
Function Descriptions	Medical Mode	27
	Health Care Mode	28
	Brain Massage Mental Massage	29
	Manual Mode	30
<hr/>		
Special Function Descriptions	XD PEMF Module Description	31
	Brain Massage Program	32
	Mental Massage Program	34
<hr/>		
Product Specifications	Product Maintenance	35
	Product Specifications	36
	Symbol Descriptions	37
<hr/>		
Troubleshooting	Troubleshooting Guides	38
	Customer Support Guidelines	39
<hr/>		
Warranty	Warranty Terms And Conditions	40

Important Safety Instructions

- ※ Please follow these instructions as they are intended to prevent unexpected risks or damage through safe and accurate use of the product.
- ※ These instructions indicate the level of potential hazard with the labels of "Caution" and "Warning" as shown below.

 **Warning** To lower the risk of burn, fire, electric shock and injury.

 **Caution** To prevent injury.

Safety Precautions Before Use

Warning

Do not install or use in bathrooms or areas with high humidity levels. This could result in electric shock.

May cause electric shock, fire, deformation, mold, and malfunction.



Avoid using in areas with dust or areas prone to rust.

May cause electric shock, fire, deformation, mold, and malfunction.



Do not operate this device in settings with temperatures exceeding 104°F or directly under sunlight.

May cause fire and malfunction.

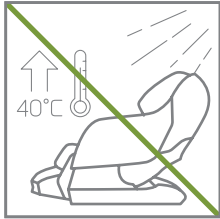

Do not install outdoors.

May cause safety accidents, injury, product damage and malfunction.



Do not use near heaters or anything radiating heat.

May cause damage to the product, fire and malfunction.

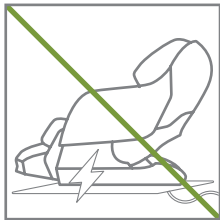

Install and use only when properly grounded on flat surfaces.

May cause safety accidents, injury, product damage and malfunction.



Important Safety Instructions

Safety Precautions Before Use

Warning

Use in areas with ample space and reasonable air circulation.

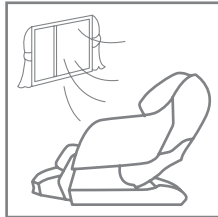

May cause deformation, mold and malfunction.

Do not use after arbitrarily disassembling parts. This can result in product malfunctions.

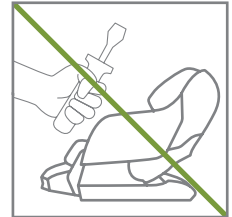

May cause safety accidents, injury, product damage and malfunction.

Do not use concurrently with other electronic or medical devices.



May cause safety accidents, injury, product damage and malfunction.

Do not spill liquids or use aerosol (spray) products.



May cause deformation, product damage, safety accidents and injury.

Do not place heavy objects on top of this product.

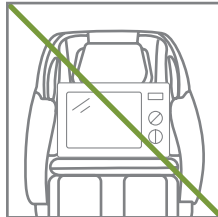

May cause safety accidents, injury, product damage and malfunction.

Please take precautionary measures to ensure toddlers and pets do not crawl under the body of the chair, leg rest, etc. to prevent any injuries or damage.

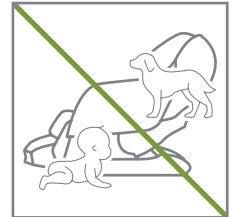

May cause safety accidents, injury, product damage and malfunction.

Caution

Do not install or repair the device without the assistance of a technician.



May cause safety accidents, injury, product damage and malfunction.

Do not use the product other than the uses described in the manual.



May cause safety accidents, injury, product damage and malfunction.

Important Safety Instructions

Safety Precautions Before Use

Caution

Do not pull aggressively on the cord of the device.

May cause electric shock, fire and malfunction.

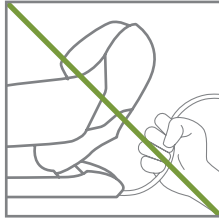

Plug device into a 110-120V~ power outlet only.

May cause malfunction or electric shock due to short circuit.

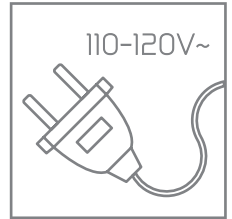

Check the power status of the device before use.

This ensures correct use of the device.

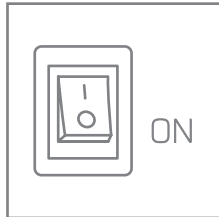

When disconnecting the power cord, do not pull on the cable. Hold the plug and pull to disconnect safely.

May cause electric shock, fire and malfunction.

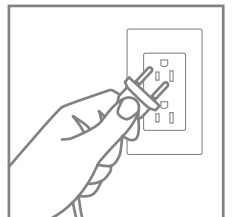

Do not install in areas where it is difficult to disconnect the power cord.

May cause safety accidents, injury, product damage and malfunction.

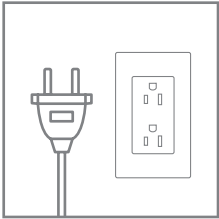

Be careful when wearing dark-colored clothes such as jeans, as there is a possibility that the product sheet may get stained.

May cause stains.

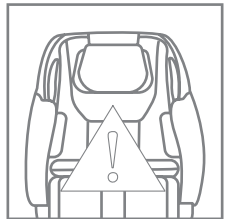

Use after checking that the product's safety sensor is activated and that toddlers and pets are not near when the device returns to its original position.

May cause safety accidents, injury, product damage and malfunction.

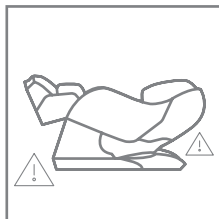

Refrain from using in areas where temperatures highly fluctuate.

May cause injury.

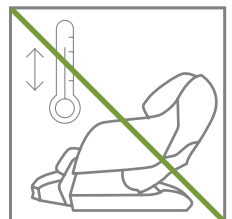

Important Safety Instructions

Safety Precautions During Use

Warning

Refer to the operation guide and review situations of negative side effects of using this device.

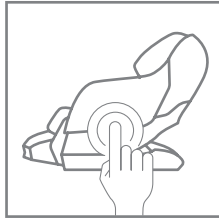

This ensures the correct use of the product.

Do not connect or disconnect the power cord with wet hands.

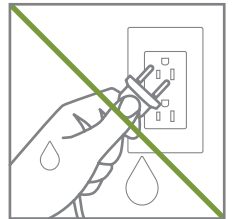

May cause electric shock, fire and malfunction.

Do not use the device if the body is still wet.



May cause electric shock, fire and malfunction.

Do not use immediately after eating.

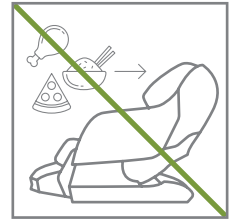

May cause injury.

Make sure parts of the body do not get caught in crevices of the device.

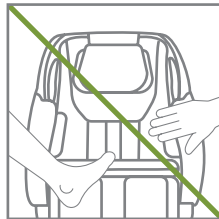

May cause safety accidents, injury, product damage and malfunction.

Be careful, as intensive use on certain parts of the body may cause strain.

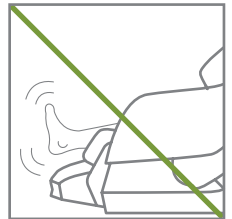

May cause safety accidents, injury, product damage and malfunction.

When not in use, disconnect the plug from the outlet.

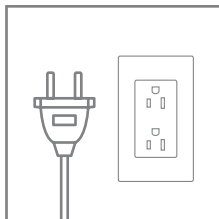

May cause malfunction or electric shock due to short circuit.

Infants and children should refrain from using the product.

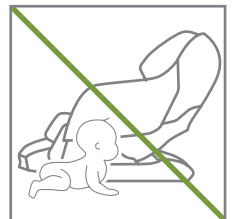

May cause safety accidents, injury, product damage and malfunction.

Operate device for intended use and on intended areas of the body.

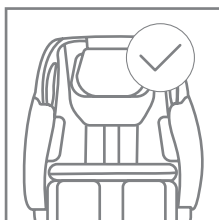

May cause safety accidents, injury, product damage and malfunction.

When the massage ball operates, adjust and allow it to operate in the right position.

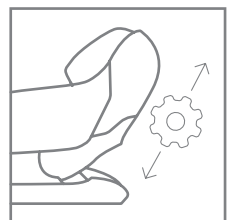

May cause safety accidents, injury, product damage and malfunction.

Important Safety Instructions

Safety Precautions During Use

Warning

Wait for the device to completely return to its original angle before getting up from it.

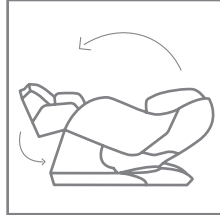

May cause safety accidents, injury, product damage and malfunction.

Stop using immediately if you experience any pain or discomfort and follow up with adequate measures.

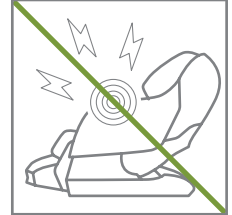

May cause injury.

Continuous use may strain the body, so use accordingly to the user's health condition.

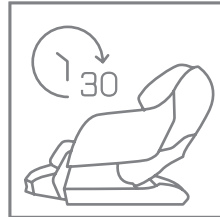

May cause injury.

Be careful not to let infants or pets play with the product during use.

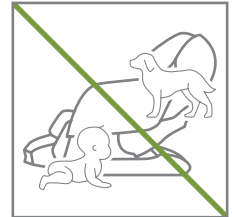

May cause safety accidents, injury, product damage and malfunction.

Do not operate in places where aerosol (spray) products or oxygen is used.

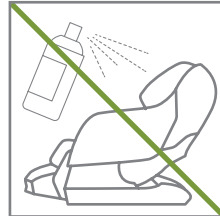

May cause product damage, fire, explosion and malfunction.

Do not use wearing accessories.

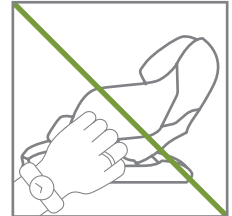

May cause safety accidents, injury, product damage and malfunction.

Make sure hair does not get stuck during use.



May cause safety accidents and injury.

Be careful not to drop or put in any objects inside the gaps of the product.

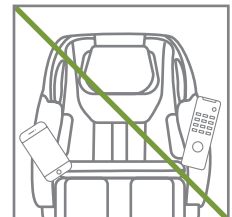

May cause safety accidents, injuries, product damage and fire.

If the cord or plug is damaged, doesn't function properly, or is submerged in water, do not use. Contact the service center for inspection and repair.

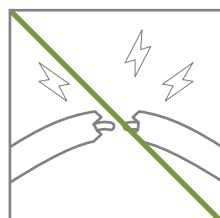

May cause electric shock, fire and malfunction.

Be aware of burning when using the heating function.



May cause low temperature burns.

Important Safety Instructions

Safety Precautions During Use

Warning

Use after sitting in the correct position.

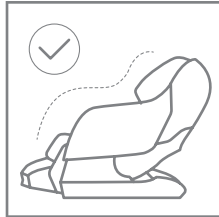

May cause safety accidents, injury, product damage and malfunction.

Do not use if the cover is torn or uncovered.

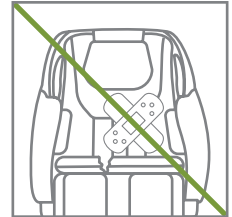

May cause safety accidents, injury, product damage and malfunction.

Caution

No more than one person should operate the device at once.



May cause safety accidents, injury, product damage and malfunction.

Be careful not to damage the cord or bend excessively.

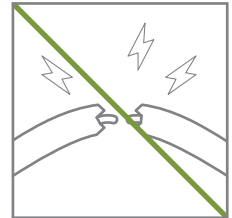

May cause electric shock, fire and malfunction.

Be aware of the individual's body temperature when using the device, especially if the individual falls asleep.



May cause safety accidents and injuries.

Refrain from use if over 100kg/220lbs.

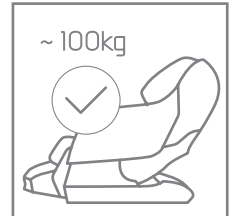

May cause safety accidents, injury, product damage and malfunction.

Do not stand on the device. Only use sitting down.



May cause safety accidents, injury, product damage and malfunction.

When the product reclines, be careful not to stand on the leg unit.



May cause safety accidents, injury, product damage and malfunction.

Important Safety Instructions

Safety Precautions During Use

Caution

Make sure pets do not chew the power cord.

May cause electric shock, product damage and malfunction.

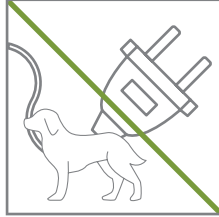

Start massage at a low intensity and build up for safe operation practices.

May cause injury.



Do not lift the leg unit with your hands.

May cause safety accidents, injury, product damage and malfunction.

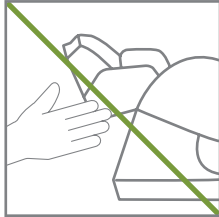

Do not lean on or hang on the backside of the product.

May cause safety accidents, injury, product damage and malfunction.



Keep the controller in its designated location and do not pull on the cord aggressively.

May cause safety accidents, injury, product damage and malfunction.

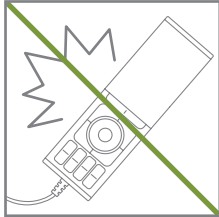

Do not press the buttons rapidly and make sure they are not pressed down.

May cause safety accidents, injury, product damage and malfunction.

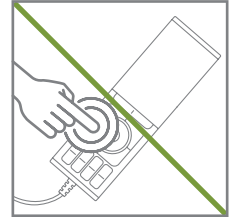

Make sure the switch is off before plugging in the power cord.

May cause electric shock, product damage and malfunction.

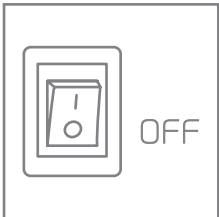

Do not sit on the backside, arm unit or leg unit.

May cause safety accidents, injury, product damage and malfunction.



Do not use the bluetooth speaker for too long at a high volume. (*Limited to only certain products)

May cause hearing damage.

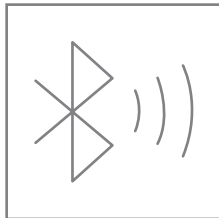

If the product malfunctions while using the head strap, first remove the head strap and then come out.

May cause safety accidents, injury, product damage and malfunction.

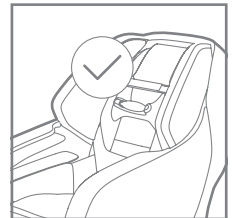

Important Safety Instructions

Safety Precautions During Use

Caution

Use a leather cleaner to wipe products with natural leather sheets. (*Limited to only certain products)

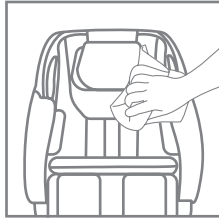

May cause product damage.

Do not wash with water.

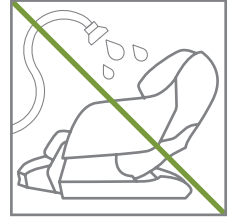

May cause electric shock, fire and malfunction.

Disconnect the power cord when cleaning the product.

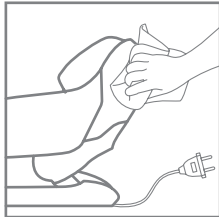

May cause safety accidents, injury, product damage and malfunction.

Use a soft cloth to clean the product. Do not use thinners, organic solvents or other chemicals.



May cause product damage.

When charging with the USB cable, please use a shielded cable. (*Limited to only certain products)

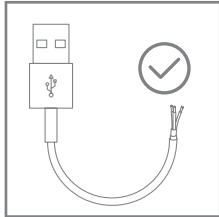

May cause electric shock, fire and malfunction.

※ Shielded cables refer to cables that have aluminum foil wrapped around the wires or closely woven copper or steel in a mesh form to suppress noise from both outside and inside.

Important Safety Instructions

Safety Precautions During Use

Prohibited

- **Do not use if**
 - Suffering from thrombosis, embolism, a serious or an acute form of varicose veins or when advised by a healthcare professional not to use this device.
 - Within the first trimester and the beginning of the third trimester of pregnancy.
 - Suffering from acute organ diseases or chronic heart illnesses.
 - Schizophrenic or suffer from other mental illnesses.
 - Probable to experience seizure, stroke, or have any sensory illnesses or disorders.
 - User has difficulties moving alone.
- **Please consult a medical professional before using if**
 - User is pregnant or has a probability of experiencing negative side effects after using device.
 - User shows signs of inflammation and experiences higher than normal body temperatures.
 - User suffers from skin disease or any skin-related illnesses.
 - User suffers from malignant tumors.
 - User is experiencing muscle loss due to various reasons.
 - User is currently being treated by a doctor or needs stable environment conditions.
 - Suffering from cervical sprains, herniated cervical discs, or any form of acute whiplash.
 - Suffering from severe osteoporosis.
 - Using a pacemaker or any implantable medical device.
 - Experiencing difficulty expressing or moving parts of the body.
 - User is experiencing any other health concerns.
 - Please supervise young children, seniors and medical patients when they are using this device.
 - Do not fall asleep with the heating function on.

Heating Function Precautions

- Skin irritation such as low temperature burns might occur if device is used repeatedly without rest.
- Do not let areas of the device that heat up come in direct contact with skin.
- Please supervise young children, seniors and medical patients when they are using this device.
- Do not fall asleep with the heating function on.

Potential Side Effects

- **Be aware of the following side effects which may occur during use.**
 - Minor bruising, abrasions, scrapes and etc.
 - Soreness, tired muscles, and discomfort may occur due to overuse.
 - Allergic reactions or burns.
 - Spinal fracture and sprains for seniors.

Components and Descriptions

Exterior

- 01 Speaker
- 02 Neck Massage Unit
- 03 Arm Massage Unit
- 04 Seat Cushion
- 05 Leg Massage Unit
- 06 Shoulder Massage Unit
- 07 Side Panel
- 08 LED Lights
- 09 Carters
- 10 Moving Handle

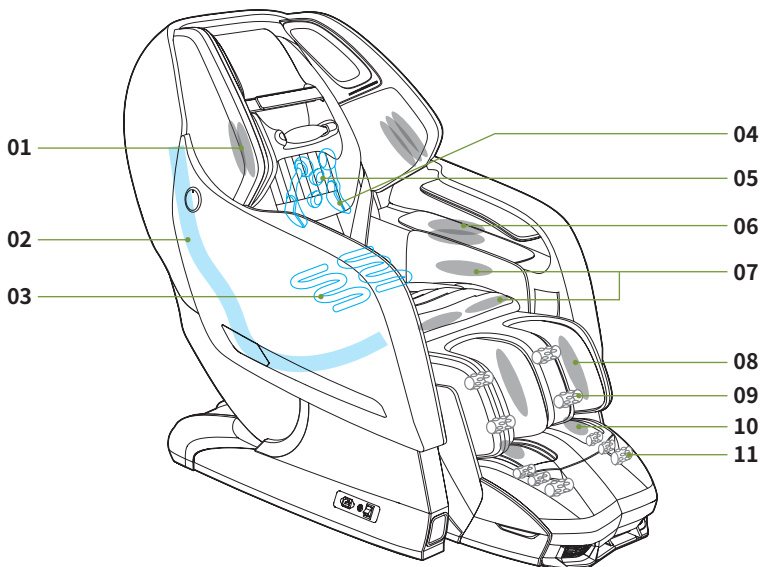
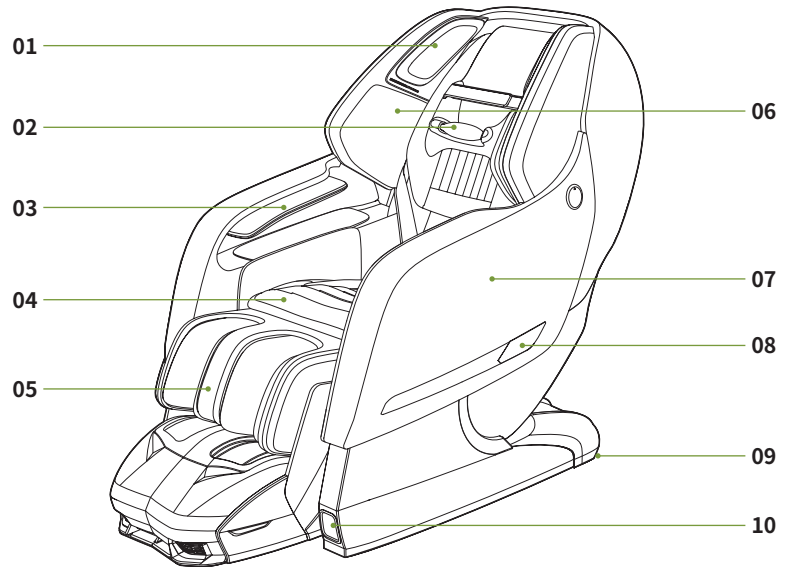

Interior

- 01 Shoulder Airbag
- 02 L&S Frame
- 03 Heated Back Unit
- 04 Massage ball
- 05 PEMF
- 06 Hand/Arm Airbag
- 07 Thigh/Pelvis Airbag
- 08 Calf Airbag
- 09 Calf Roller
- 10 Foot Airbag
- 11 Foot Roller

Transporting | Installing

Transporting and Installation

Allocate enough space before installing this device.

Remove all miscellaneous objects around or in direct contact with the chair.

Tilt the massage chair backward at an angle and move it at the desired location.

Safely place the chair securely on the floor and begin installation of the chair.

※ Do not drag and take precautions to prevent damage to the floor. We recommend two or more persons when transporting.

※ LED status means : Green and blue are working status. Red is an emergency stop (anti-trap sensor detection).

※ Acclimatization

After storing or transporting devices in a cold, or warm environment, allow at least 1 hour for the device to acclimatize to room temperature before taking any measurements.

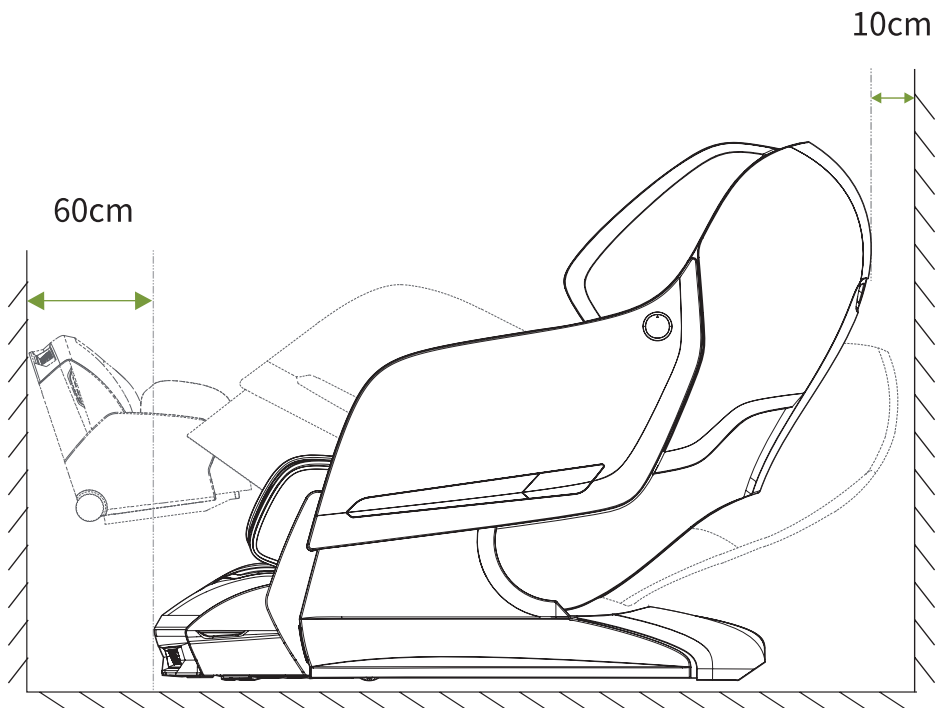

Bodyfriend is not responsible for anything that occurs due to the user's self-installation.



Installation

STEP 1. Unpack

This product is packaged in three separate boxes. Please check that you have received all necessary parts.

- **Main Box** : Main Body, Back/Hip Rest, Head rest, Shoulder Massage Unit, Accessory Box (Bolt, Controller, Power Cable, Manual)
- **Arm Unit**
- **Leg Unit**

[Bolt]

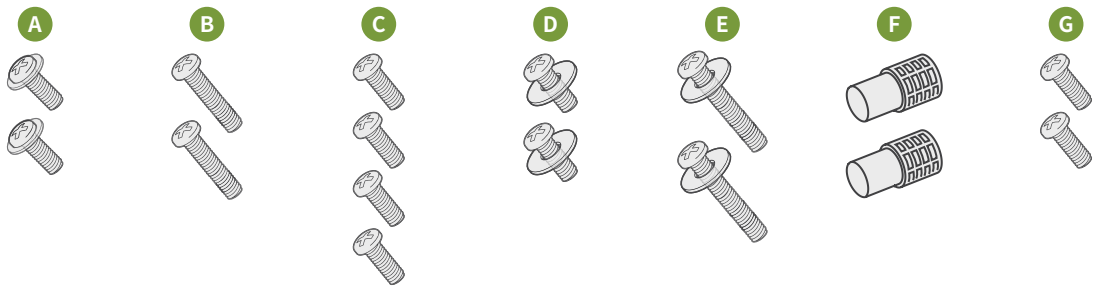

STEP 2. Installation of Shoulder Massage Unit

01 Insert the speaker connector to the shoulder massage unit until it clicks.

※ When installing the connector, be sure to turn off the power to the main body beforehand.

02 Line up the shoulder grooves with the corresponding protrusions and secure the 2 air hose ports with the shoulder massage unit (air hose fitting) and tighten the shoulder massage unit on the inside with inner screw (A).

03 Tighten 1 short screw (C) onto the shorter of the two protrusions and tighten 1 short screw (C) onto the bottom of the taller protrusion and 1 long screw (B) at the top.

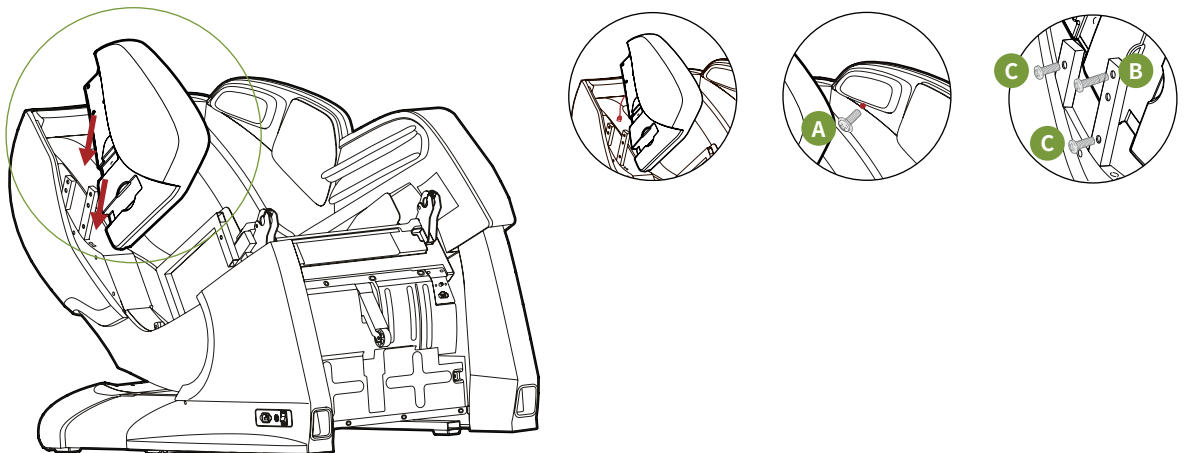

Installation

STEP 3. Connecting the Side Panel (Arm Unit)

01 Insert the red and black connectors into the corresponding color ports until they click into place. Firmly connect the air hose until it is all the way in.

※ When installing the connector, be sure to turn off the power to the main body beforehand.

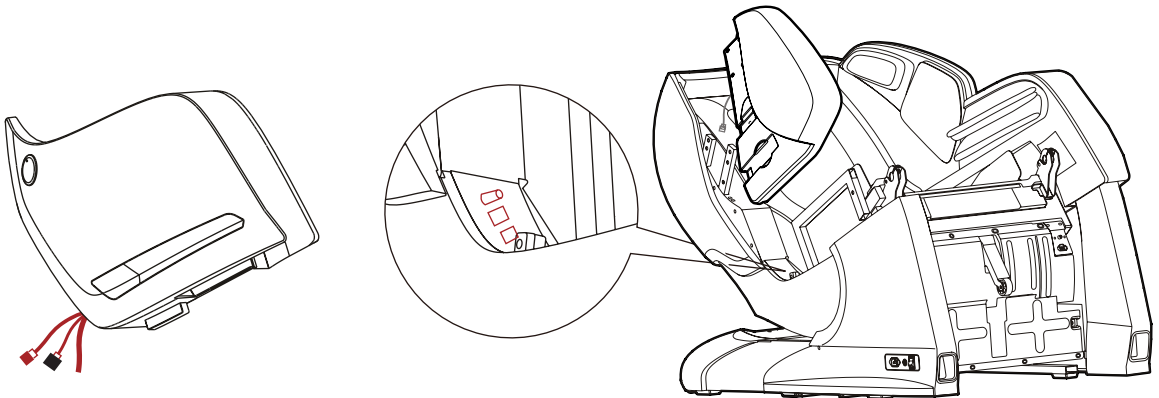

02 Carefully place the arm unit over the steel frame so that the arm unit is correctly in place with the bottom protrusion resting in the corresponding slot and the screw hole being visible on the inside part of the arm section (the screw hole is partially covered by the hip air bag). Lower the flap inside the chair.

03 Tighten the inner screw (D) of the arm massage unit.

04 After tightening the outer screw (E) of the arm massage unit, insert the plastic cap (L for Left side; R for Right side).

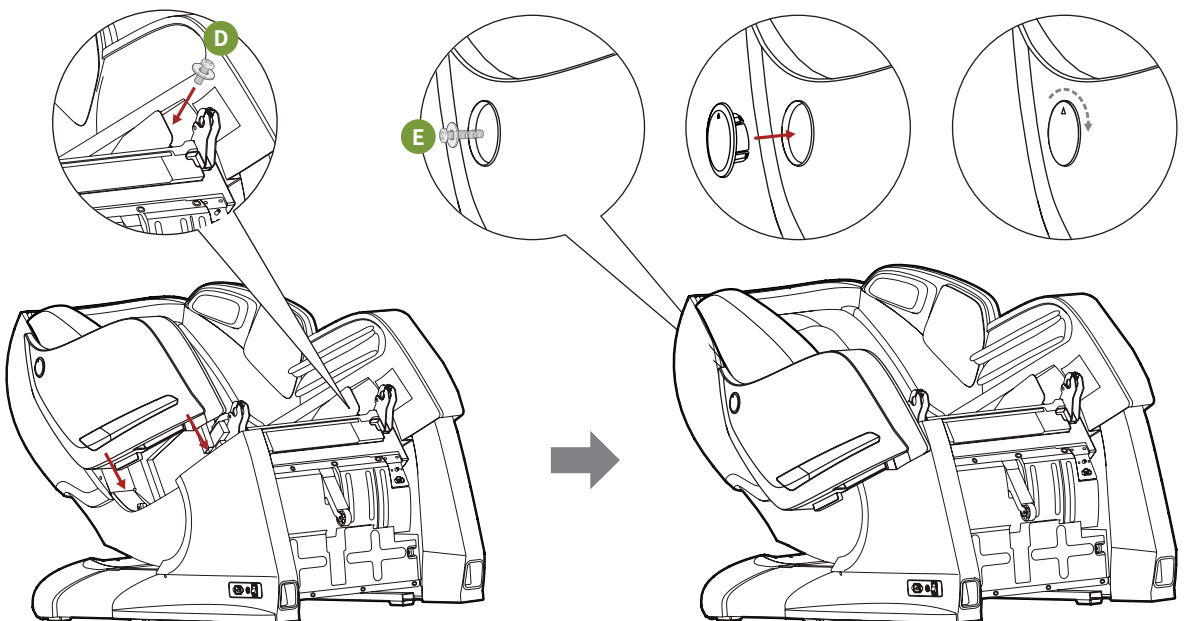

Installation

STEP 4. Connecting the Controller

Connect the controller cord with its port (located inside the right side panel).

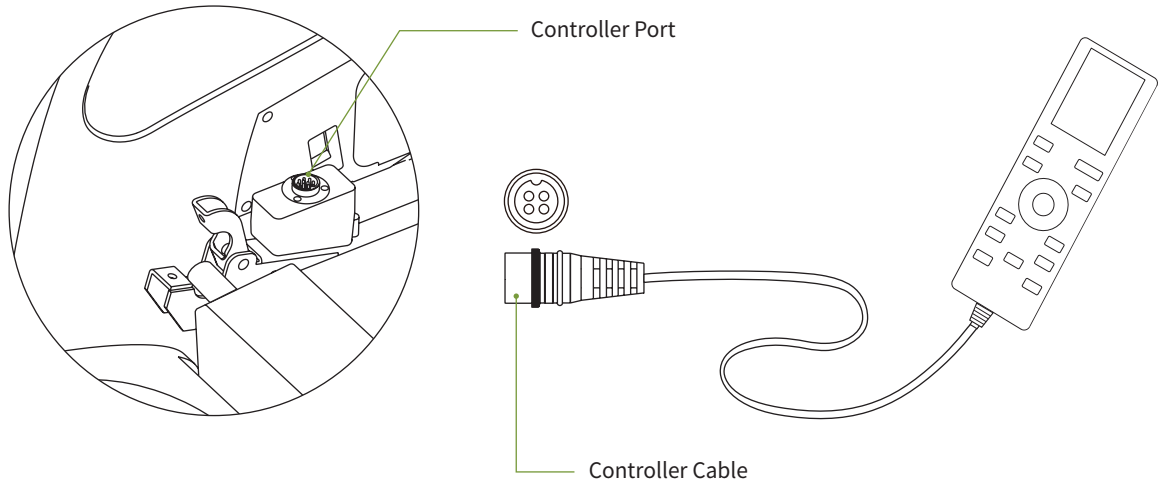

STEP 5. Connecting to Power Source

01 Connect the power cable to its port (located on the lower right of the main body)

After connecting, turn on the power switch.

02 Press the power button to turn on the massage chair and then press the power button and confirm, returning the chair to its original position. The screen may not turn off after returning to its original position in which case you can press the power button to turn it off.

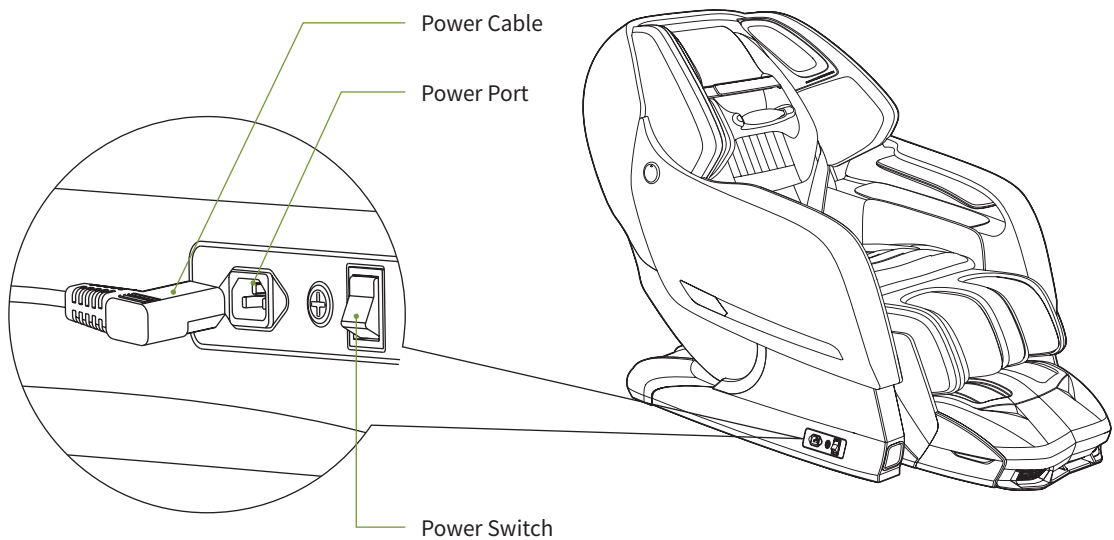

Installation

STEP 6. Connecting the Leg Unit

01 Insert the feet sole connector In to the corresponding port body until it clicks. Plug in the air hose. Make sure the air hose is completely In.

※ When installing the connector, be sure to turn off the power to the main body beforehand.

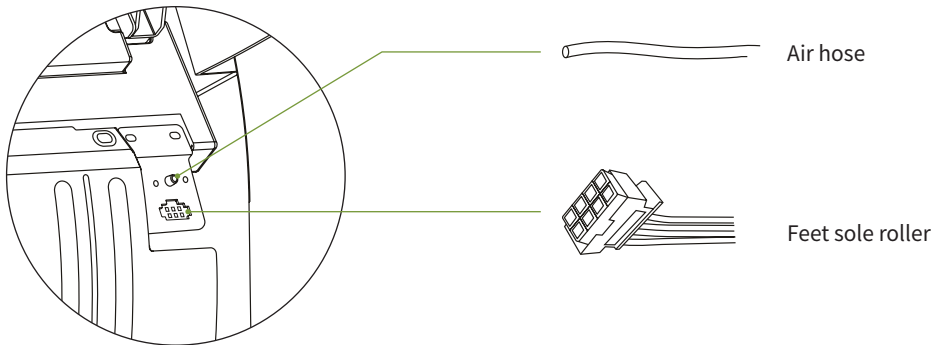

02 Remove the body part connector covers and then remove screw (G) from both body part connectors and raise up the latch. Insert hinge (F) onto both sides of the leg unit and then carefully place the hinged part into the Body Part Connector.

03 Close the latches and tighten screw (G).

04 Turn on the chair and press the Leg Rest Adjust button Up until the leg is fully up. Then press the Leg Extend button until the leg is fully extended. Press the power button to pause the chair. Slide on and fasten the Body Part Connector covers on both sides. Lastly close the zipper connecting the seat with the leg unit.

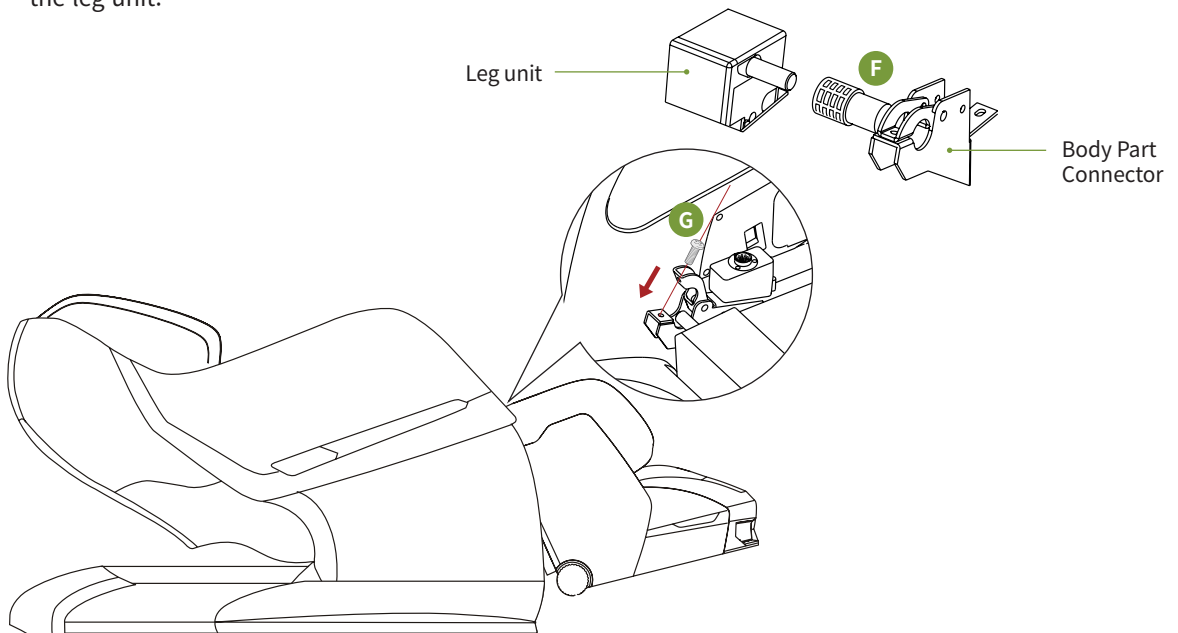

Controller Descriptions



Controller Components

- 01 Current Massage Mode Indicator
- 02 Back Massage Speed Indicator
- Back Massage Intensity Indicator
- Back Massage Width
- 03 XD Massage Intensity Indicator
- 04 Current Massage Location Indicator
- 05 Power ON/OFF
- 06 Menu
- 07 Enter
- 08 Leg Angle Adjust
- 09 Leg Extend/Retract Adjust
- 10 Connector for remote control upgrade
- ※ The connector can be used during warranty service
- 11 Time Elapsed Indicator
- 12 Music Play Indicator
- 13 Message Spot Indicator (Full/Part/Fixed)
- 14 Massage Technique Indicator
- 15 Heat Indicator
- 16 Zero Gravity Indicator
- 17 Bluetooth Connectivity Indicator
- 18 PEMF Mode Indicator
- 19 Back Massage Up/Down
- 20 Auto Mode
- 21 Full Body Angle Adjust
- 22 XD Massage Adjust

Slide Safety Mode

This is an auto slide angle-adjust product. If you press POWER while using the product, a message saying "Do you want to end" comes up. Please be careful with pets or children; don't get caught in the slide part when it returns to its original position. In the event of a pinch accident, please press any button on the controller, which will stop the slide automatically and you can use it safely.

Controller Descriptions



Power

This button turns the chair on and off.
If this button is pressed during operation, all movement will stop and all parts of the massage chair will return to their original resting position.



Massage Location Up/Down

This button adjusts the location of the back massage balls.
※ For adjustment please select [Manual Mode] > [Spot Adjust] > [Fix]
※ You can adjust massage spot for shoulders during auto mode.



Menu

This button causes the menu screen to appear if pressed during operation to allow the user to adjust the settings.



Auto Mode

This button will quickly transition the massage mode to a different Auto-Mode if pressed during operation.

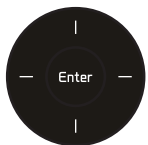

Enter

You may select a function with the [Up/Down/Left/Right] button and start with the [Enter] button.
When playing brain massage music, use the [Left/Right] button to change the music and use the [Up/Down] button to control the volume.



Leg Rest Adjust

These buttons allow leg angle to be adjusted.



Reclining

These buttons adjust the recline angles for the body.



Leg Extend Leg Retract

These buttons extend or retract the leg unit.







XD Message

Customized XD massage system allows the user to set the range for the roller heads to protrude along the contours of the user body.

How To Use

How to use the product

- 01 Plug the power cord into the power outlet.
- 02 Turn on the main power switch. 
- 03 Turn on the power button on the controller. 
- 04 Select and run the desired mode on the controller.
- 05 Turn off the chair by pressing the power button on the controller after use. 
- 06 Turn off the power by pressing the main power switch. 

Body Recognition - How to change the location of the massage module (Auto-Mode)

- 01 Turn on the power, press Menu and select [Auto-Mode].
- 02 If you select one of the [Auto-Mode], automatic body scanning starts.
- 03 When the automatic body scanning is finished, the location arrow of the shoulder module is created.
- 04 Move the massage module location to the user's shoulder position with the massage spot [Up/Down] adjustment buttons.

How to use the neck massage head strap

※ Please adjust the neck massage unit according to the individual's neck position.

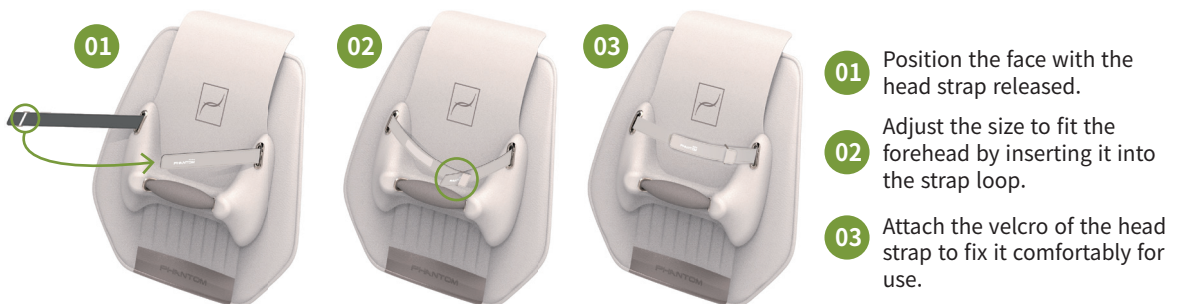

Controller Function Descriptions

Medical

Select [Medical] > Select desired mode > Massage will start after body scanning.

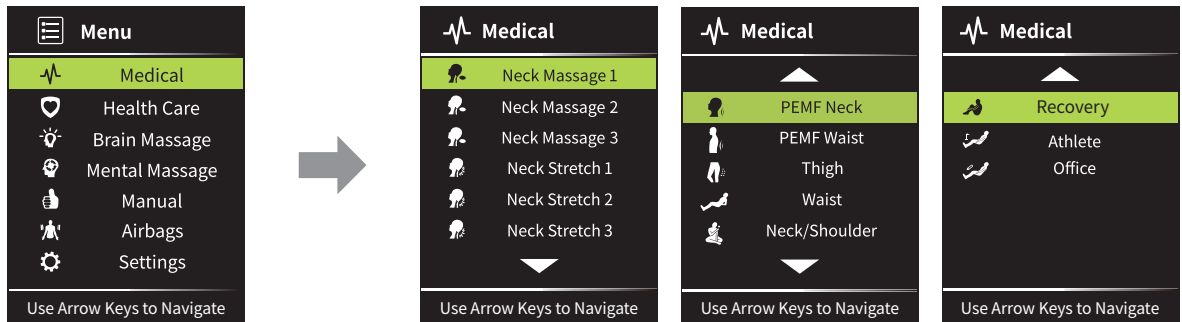

Health Care

Select [Health Care] > Select desired mode > Massage will start after body scanning.

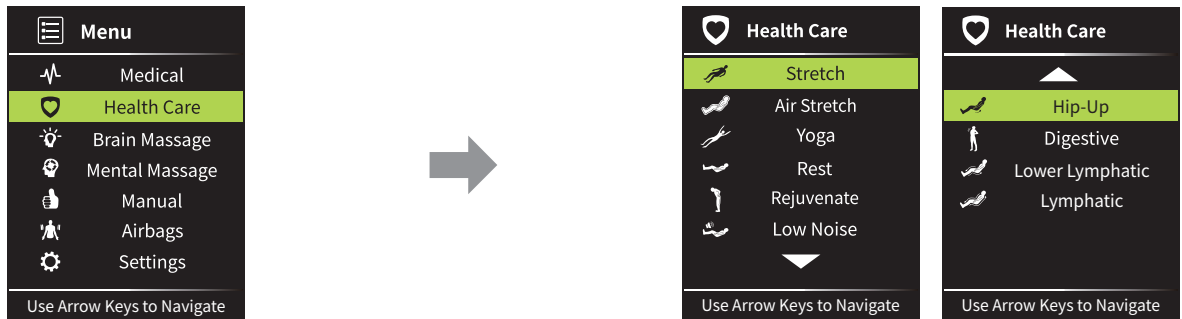

⚠ Please do not try stretch mode for elderly and pregnant women.

Controller Function Descriptions

Brain Massage

Select [Brain Massage] program > Select desired mode > Massage will start after body scanning.

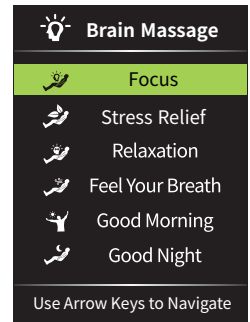
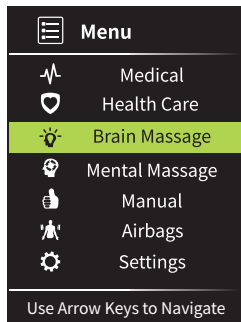

Mental Massage

Select [Mental Massage] program > Select desired mode > Massage will start after body scanning.

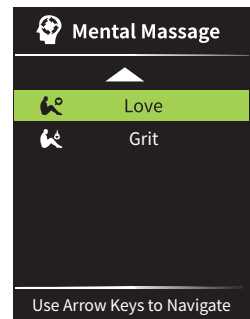
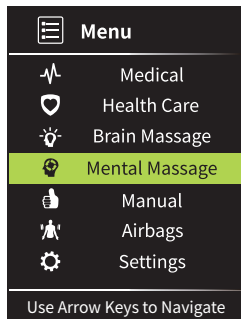

※ Brain massage and Mental massage modes are not medical device functions.

Controller Function Descriptions

Manual

Select [Manual] program > Select preferred mode. Press Enter button to start according to the selected settings.

The following table summarizes the settings shown in each of the nine screenshots:

Screenshot	Setting	Value
1	Menu	Manual
2	Technique	Kneading
3	Technique	Full
4	Technique	Wide
5	Spot	1
6	Spot	2
7	Spot	3
8	Spot	4
9	Spot	5
10	Spot	6
11	Spot	Off
12	Zero G	Strong
13	Zero G	Weak
14	Zero G	Off
15	PEMF	On
16	PEMF	Off
17	Heating	1
18	Heating	2
19	Heating	3
20	Heating	Off
21	Foot	1
22	Foot	2
23	Foot	3
24	Foot	Off
25	Calf	1
26	Calf	2
27	Calf	3
28	Calf	Off

⚠ Attention-Manual mode adjustments cannot be made when on auto mode.

Controller Function Descriptions

Airbags

Select the area of the body and intensity of the airbag massage.

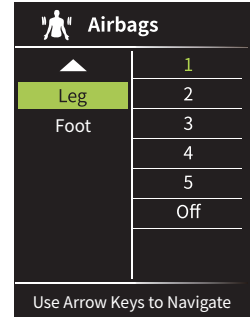
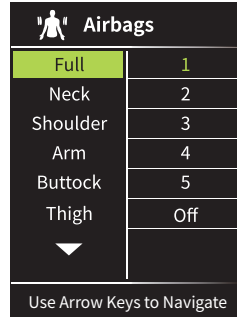
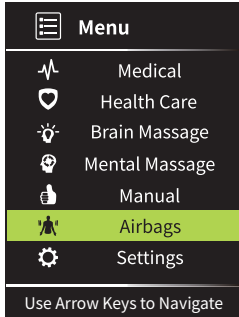

Time

Massage modes time lengths can be adjusted to 10min/20min/30min.

※ Some auto modes cannot adjust the time.

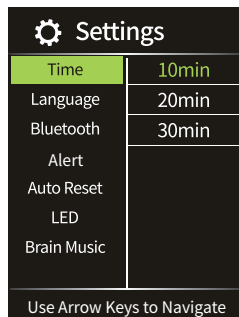
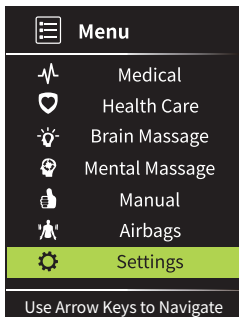

Language

We support Korean/English.

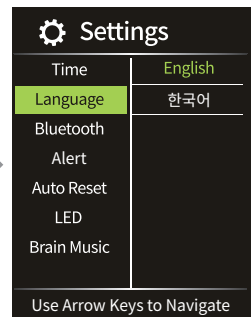
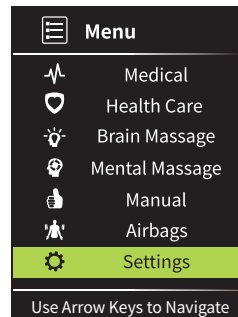

Bluetooth

Sync personal mobile device with Bluetooth function to play music through the speakers while receiving a massage.

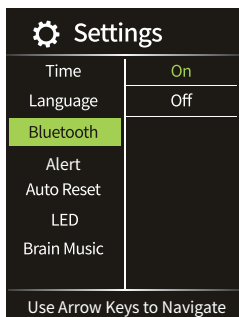
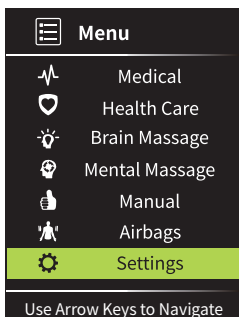

- 01 Turn the Bluetooth on in the controller settings
- 02 Turn the Bluetooth on in the cell phone settings
- 03 Start searching for the device on your cellphone. When the device name appears on your cellphone, pair it, and the bluetooth will be connected.

Controller Function Descriptions

Alert

It beeps to inform the user when the massage ends.

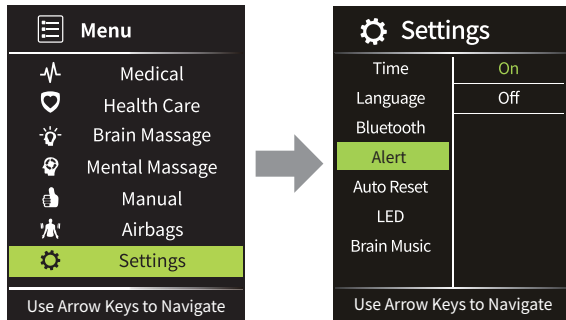

Auto Reset

When the massage is finished, the chair will automatically recline back into its initial position. You can turn this ON/OFF.

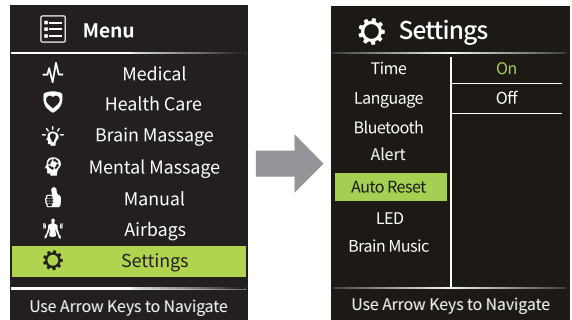

LED

This is a side panel LED ON/OFF function.

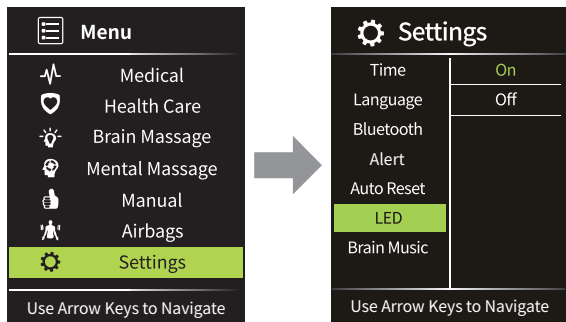

Brain Music

This function allows you to select music per mode or set the volume of music.

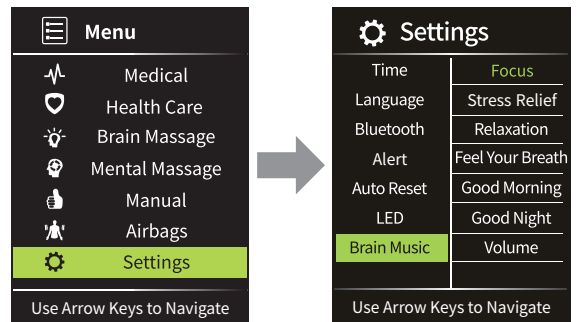

Medical

Medical

Select [Medical] > Select desired mode > Massage will start after body scanning.

Neck Massage 1~3	This course massages around the neck through airbags and massage modules. ※ The higher the mode, the stronger the massage. If you use it with a strong setting from the beginning, it can put a strain on your body, so use [Mode 1] and gradually increase it to fit your body. When you start [Mode 3], a stretching function is provided to help you get the correct posture. Don't be surprised.
Neck Stretch 1~3	This course provides a gentle neck massage. ※ The higher the mode, the stronger the massage. If you use it with a strong setting from the beginning, it can put a strain on your body, so use [Mode 1] and gradually increase it to fit your body. When you start [Mode 3], a stretching function is provided to help you get the correct posture. Don't be surprised.
PEMF Neck	It intensively moves the neck area and relieves pain around the neck at the same time through a pulsed electromagnetic field.
PEMF Waist	It intensively moves around the waist and relieves pain around the waist at the same time through a pulsed electromagnetic field.
Thigh	It adds muscle stimulation by fixing calf and ankle airbags and a thigh airbag that stimulates muscle quadriceps femoris and muscle biceps femoris. This is a course where you can feel the effect of stretching and alleviating minor muscle pain through stimulation of each muscle.
Waist	It is a course where you can feel the pain relief effect of muscles by intensively massaging the back and pelvis and acupressure.
Neck/ Shoulder	This course relieves pain by intensively massaging the shoulder and neck area and relaxing the surrounding muscles with acupressures, etc.
Recovery	This course massages the whole body and features gentle pressure on the neck and back.
Athlete	This course relieves pain in the muscles used while playing golf by massaging the shoulders and legs, which are easily fatigued after playing golf, and providing strong acupressure using a roller.
Office	This course relieves neck and shoulder massage and lower back pain, which is easily caused by sitting for a long time.

※ PEMF : Pulsed electromagnetic field

※ If you feel any abnormality in your body during use, stop using it immediately and consult a specialist.

Health Care

Health Care

Select [Health Care] > Select desired mode > Massage will start after body scanning.

Stretch	This course is a powerful stretch by pulling your legs toward the floor while lying down.
Air Stretch	This is a relaxation course that provides a gentle massage using an airbag without the operation of the massage module.
Yoga	This course provides dynamic massage and stretching using yoga movements that create a flexible body.
Rest	This course induces sleep through a gentle full body massage in a monotonous pattern for 30 minutes.
Rejuvenate	This is a light and strong massage course with kneading and tapping at the same time.
Low Noise	This is a full body massage course excluding airbags that can be used even at night when noise is sensitive.
Hip-up	It is a course that stimulates the buttock muscles by kneading and tapping to make them elastic.
Digestive	This course helps by stimulating the main points of the back, which helps with a hangover.
Lower Lymphatic	This course specializes in stimulating the calf airbag in a lying position and removing leg swelling through the sole roller.
Lymphatic	This is a circulation course that helps relieve swelling using whole-body airbags.

Brain Massage | Mental Massage

Brain Massage

Select [Brain Massage] program > Select preferable mode. The massage will automatically start after Auto Body scanning feature.

Focus	Massage mode for those who experience reduced Focus levels due to reasons such as extended periods of studying or overwork.
Stress Relief	This is a massage course for those who want to take a break from excessive stress in daily life.
Relaxation	Massage mode for those who often experience muscle strain and mental fatigue.
Feel Your Breath	Massage mode for those who have a hard time concentrating on work in daily life and easily get angry.
Good Morning	An energetic massage mode for those who have a hard time waking up in the morning; Helps activate brain functions after a sleep.
Good Night	Massage mode for those who had a long day and want to take the edge off and get rid of heavy thoughts.

Mental Massage

Select [Mental Massage] program > Select preferable mode. The massage will automatically start after Auto Body scanning feature.

Heal Your Mind	Healing massage mode for those who regret past actions and for those who feel depressed.
Full of Hope	Healing massage mode for those who feel anxiety and restlessness due to uncertainty.
Self-Esteem	A course that helps you recover your self-esteem by comforting your mind when you feel small and heavy with worries.
Appreciation	This course helps you change your mood by ruminating on valuable things in your daily life.
Forgiveness	A course that offers forgiveness for yourself and comforts them through music.
Trauma	A course that provides peace of mind for those who have suffered from past memories.
Love	This course proposes a way to love the present self through massage and relaxation of the mind.
Grit	This course is suggested so that you can feel the grit that exists in your heart with massage.

※ Brain massage and Mental massage modes are not medical device functions.

Manual

Manual

Select [Manual] program > Select preferred mode. Press Enter button to start according to the selected settings.

Massage Technique	You can choose from [Kneading, Tapping, Chopping, Acupressure, Combination, Rhythmic]
Massage Spot	[Full] Massages the upper and lower parts of the body. [Partial] Operates the massage for the entire part and selects [Partial] massage when you arrive at the desired part. ※ Manual adjustment is not possible with the up/down control button. [Fixed] After selecting a massage, you can move it at any time by using the massage position adjustment buttons (up/down).
Massage Width	You can adjust the width of the massage ball spacing in the back massage part. You can select an interval according to your body type among massage intervals.
Massage Speed	You can adjust the massage speed of the back massager. Select the massage speed according to the desired speed. You can receive a more effective massage by additionally adjusting the isometric angle / leg angle. ※ Speed adjustment is not possible in acupressure mode.
Zero Gravity	You can select [Level 1 / Level 2 / Level 3 / Off] to receive. ※ Zero-gravity mode is not a medical device function.
PEMF	You can receive it by selecting [Strong / Weak / Off].
Heating	You can receive it by selecting [On / Off].
Foot	You can select [Level 1 / Level 2 / Level 3 / Off] to receive. ※ Foot massager airbag is activated at the same time.
Calf	You can select [Level 1 / Level 2 / Level 3 / Off] to receive. ※ Calf massage part airbag is activated at the same time.

XD PEMF Module Description

Bodyfriend's unique PEMF electromagnetic generator and XD module combination system

1. It provides massages that relieve minor muscle pain through a PEMF electromagnetic generator that moves along the spinal line (neck-back-waist-pelvis/cervical spine-thoracic spine-lumbar spine).

We provide massages to relieve minor muscle pain.

2. Effect by generating a magnetic field in the form of a pulse rather than a fixed magnetic field (minor muscle pain relief)

※ XD (EXTREME DIMENSION)

5-Level XD module that the user can choose

It provides massage along the skeleton of the muscles in the neck, shoulder, and trapezius muscles by scanning the user's body.

- The massage module comes down from top to bottom and senses the load to accurately recognize the shoulder and adjusts the shoulder position in real time during operation.
- Massage intensity that changes elastically according to the user's load
- Massage system to provide sophisticated and gentle massage
- Select the desired stimulus intensity by adjusting up to 5 levels selected by the user



Brain Massage Program

Brain Massage - Rested Brain Leads to Improved Productivity.

BODYFRIEND's exclusive massage modes combine massage and binaural beat healing music to improve brain activity.

※ Binaural beats : A third sound that is created in the brain when two sounds with varying frequencies enters each ear. This third sound aligns with brainwaves to allow the body to experience a deeper level of relaxation and also heighten concentration levels.

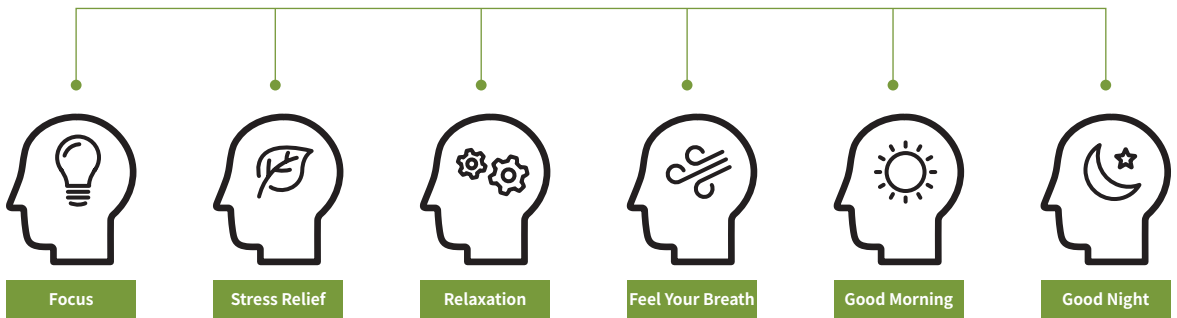

Brain Massage - Focus / Stress Relief

BODYFRIEND's exclusive massage modes combines massage and binaural beat healing music to improve brain activity.

Focus	A massage to help heighten Focus levels for those that experience reduced levels of Focus due to various factors such as extended periods of studying or overwork. Kneading and tapping massage focused on the neck, shoulders, and back to increase blood flow to the brain while binaural beat healing music plays to enhance cognitive skills.
Stress Relief	This program is for those who want to take a break from excessive stress from daily life. Relieve accumulated stress with the XD brain sound and massage pattern optimized for it.

- ※ 'Brain Massage - Focus, Stress Relief' is a mode that automatically changes the angle. After automatic angle guidance, you can manually adjust the angle.
- ※ For optimal Brain Massage, please refrain from changing the healing music during massage.
- ※ Brain massage modes are not medical device functions.

Brain Massage Program



Brain Massage - Relaxation / Feel Your Breath

Brain massage courses that promote revitalization of the body and mind through healing music with the voice guidance, inducing breaths and promoting muscle relaxation.

Relaxation	Massage mode for those who often experience muscle strain and mental fatigue. Improves concentration specializing in upper body spots such as neck, shoulders, back.
Feel Your Breath	Massage mode for those who have a hard time concentrating in daily life or get upset easily. Alleviates tension and anxiety by optimal acupressure spots on the body.

Brain Massage - Good Morning / Good Night

Brain massage courses that help to start a day vigorously and finish it off with a rested mind.

Good Morning	Designed for those who have a hard time waking up in the morning; helps activate brain functions after sleep. Put you in a good mood before starting the day by energizing the whole body and mind with positive thoughts through healing music and kneading/tapping massage techniques.
Good Night	Designed for those who had a long day; helps by taking the edge off and getting rid of heavy thoughts. Softly massages the body alongside healing music helping to finish the day with rested mind.

※ Brain massage modes are not medical device functions.

Mental Massage Program

Mental Massage

Special massage courses by BODYFRIEND that heal your mind by using bilateral stimulation* and cognitive-behavioral therapy to help control unstable emotions.

※ **Bilateral Stimulation** : Mental therapy technique used when an individual struggles with distressing memories of the past, bringing negative thoughts and feelings. It is an effective way to convert negative feelings and emotions in the limbic system into positive thoughts.

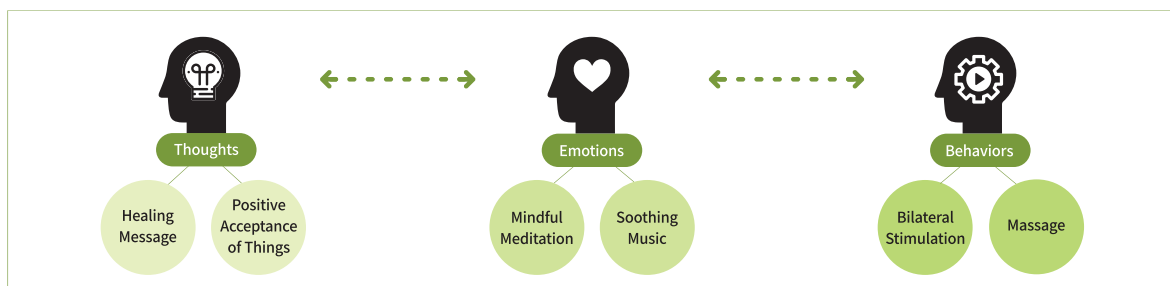

Heal Your Mind	Healing massage for those who suffer from distressing memories, negative feelings, and associated emotions. Comforting and uplifting massage that helps to convert negative emotions into positive through body massage with bilateral stimulation.
Full of Hope	Healing massage for those who feel anxiety and restlessness due to uncertainty. Helps to control emotions through relaxation of tensed muscles and full body massage with bilateral stimulation and healing messages.
Self-Esteem	This program helps to fill the emptiness within, provides comfort during times of disappointment and regret, or when you feel insignificant.
Appreciation	This program refreshes you by helping you concentrate on yourself and reminisce about precious things in your everyday life.
Forgiveness	This program helps to forgive long held grievances that cause issues in the present day through relaxing music, narration, and healing massage.
Trauma	It is a program that helps to stabilize your mind through stimulation of the body and mind through music and massage. For those that suffer from unexpected past incidents and painful memories.
Love	It allows you to relax now with Bodyfriend and listen to the stories of your loved ones. It is the most effective way to love the present self and make the future self-happy.
Grit	It is not always a burning passion like the first time, but grit is the lasting power that is always ingrained in my heart. ※ It is a psychological term that emphasizes the power of effort rather than talent. Grit is passion and perseverance for long-term and meaningful goals. It is the ability to persist in something you feel passionate about and persevere when you face obstacles.

※ Mental massage modes are not medical device functions.

Product Maintenance

⚠ **After use, please follow the instructions below.**

- 01 Unplug this product from the power outlet immediately after using the product.
- 02 When the product is not in use, put a cover on it to protect it from dust.
- 03 Do not plug or unplug the power cord with wet hands.
- 04 The use of cleaners other than leather-only cleaners can cause damage to the leather.
- 05 Contamination by chemicals, lotions, sweat, hair gel, and hair oil can shorten the life of the leather.

Leather Parts

01 Wipe with a soft dry cloth

- ※ If there is any contamination, wipe off the contaminated area with a leather cleaner.
- ※ Do not use strong chemicals such as thinner, alcohol, or benzene as they may deteriorate the product.



Plastic Parts

- 01 Wipe the plastic area with a cloth soaked in a mild detergent and then thoroughly wrung out.
- 02 Wipe the plastic part with a cloth dampened in plain water.
- 03 Let the product air dry.



Fabric Parts

- 01 Wipe the fabric sheet with a cloth soaked in a mild detergent and thoroughly wrung out.
- 02 Wipe the fabric sheet with a cloth dampened in plain water.
- 03 Let the product air dry.

- ※ If you use a scrubber or brush, it may damage the product.
- ※ Please be careful as there is a risk of discoloration or contamination if you wipe it with a colored cloth.























Product Specifications

ITEM	SPECIFICATION
Model	BFR-M8040US
Purpose of Use	A therapeutic massager is an electrically powered device intended for medical purposes, such as to relieve minor muscle aches and pains.
Operation Principal	Temperature : 41°F ~ 104°F Humidity : 15~90% (non-condensing) Air pressure : 700hpa ~ 1060hpa
Environmental Conditions	Temperature : -4°F ~ 140°F Humidity : 15~90% (non-condensing) Air pressure : 700hpa ~ 1060hpa
Rating	110-120V~, 60Hz
Power Consumption	380VA
Product Weight	333lbs
Size	Dimensions Upright (in) : 34.1(W) X 62.4(L) X 48.0(H) Dimensions Reclined (in) : 34.1(W) X 76.8 (L) X 37.8(H)
Surge protection	BF type class 2 mounting part
Air Pressure	280mmHg ±20%
Angle	Body Angle : 115°- 150°±5° Lower Body Angle : 0°- 90°±5°
Components	Main Body, Back/Hip Rest, Head Rest, Arm Massage Unit, Leg Massage Unit, Controller Set, Power Cable, Manual
Bluetooth	Frequency bands (transmitting and receiving) 2402 MHz ~ 2480MHz
Applicable use	Education: Users with at least primary education Knowledge: Those with general knowledge according to age Language: Those who can read and understand the manual Experience: Children under the age of 15 are used under the supervision of a guardian

EMC Compliance This product complies with the EMC standard IEC60601-1-2: 2014+AMD1:2020

Symbol Descriptions

	Indicates a caution sign.
	Indicates a warning sign.
	Indicates BF type mounting part.
	Indicates the manufacturer.
	Indicates the date of manufacture. (year and month)
	Indicates the serial number.
	Indicates reference to the manual.
	Limits the maximum and minimum operating temperatures.
	Indicates the humidity range.
	Indicates the atmospheric pressure range.
	Shows caution against moisture.
	It is a mark regarding legal waste regulation to minimize the environmental impact of waste, electrical and electronic equipment.
	Indicates the standby of the main power switch
	Indicates the terminal that supplies or receives AC power.
	Indicates ON (power ON).
	Indicates OFF (power OFF).
	Indicates the correct upright position of the transport package.
	Indicates the contents of the transport package are fragile and the package shall be handled with care.
	Indicates the items shall not be vertically stacked beyond the specified number, either because of the nature of the transport packaging or because of the nature of the items themselves.
	CLASS II Electrical equipment

Troubleshooting Guides

If you encounter minor malfunctions or errors, please refer below before contacting Customer Support.

Problem	Causes	Solutions
Massage chair does not operate.	Power button on controller was not pressed.	Press the Power button to turn the controller on.
	Auto Mode was not selected.	Press Enter to select an Auto mode.
	Power cord is not properly plugged in.	Properly plug power cord into socket.
	Dead power cord.	Please contact Customer Support.
	Burnt fuse.	Replace the provided fuse
	Electronic circuitry problem.	Please contact Customer Support.
Beeping during activation.	Machine noises occur.	Not a problem. Machines generate noise.
In case of heights of massage ball in the right and left are different.	The heights of the massage balls are different in 0.8inch structurally.	It taps alternately in a mechanical structure so it is normal.
The controller does not turn on.	Bad cable contact	Check the controller cable connection.
Noises get louder during use.	May occur after extended hours of operation.	Turn off machine for 30 min.
	Worn out after years of use.	Please contact Customer Support.
Machine suddenly stops during massage.	Accidentally pressed the OFF button.	Press the Power button to restart the machine.
	Massage time has finished.	Restart machine after 30 min.
Back motor and leg angle motor do not operate.	Check for any stuck objects.	Remove stuck objects.
	Excessive pressure is applied.	Turn off machine for 30 min.
Does not go back to original resting state.	Aggressive use. Wrong button operation	Please contact Customer Support. Press the power button twice and select [OK].
Controller overheating.	Overuse.	Restart machine after 30 min.
Power cord and controller cord overheating.	Excessive use.	Restart machine after 30 min.
	Other miscellaneous causes.	Please contact Customer Support.
Airbags do not activate.	Air hose disconnected.	Connect the connecting hose.
	Air-related power cord disconnected.	Please contact Customer Support.
Anti-trap sensor screen appears during operation OR it stops by sensing pinching.	Not a malfunction	After placing the leg in the leg massage unit, click the [OK] button. Then press the Full Body and Leg Angle button.
In case leg massage unit does not return after it is stretched.	Damaged heel sensor	If it keeps happening, please contact the customer support.
If the left and right arm air massage activates in turn.	Not a malfunction	Left/right rotation is normal due to air function
Noise occurs during leg and back angle operation.	Excessive use	Use it after 30 minutes break. If it still occurs, please contact the customer support.
Disconnection when using Bluetooth.	Not a malfunction	Slight interruption occurs due to the surrounding environment and radio waves.
External noise occurs during shoulder air massage operation.	Not a malfunction	As it is a sound generated by force applied to the exterior, occurs naturally during operation.

Customer Support Guidelines

Warranty Guidelines	Massage chair interior parts
	Mainboard, motors, air pump
	Interior electrical wiring / air hose

Fees Applied

Leather and Fabric
Any fading or deterioration of leather and fabric, product parts, etc. caused by personal use.)
※The leather of this product is made of synthetic leather. In the case of synthetic leather, depending on the frequency of use and storage conditions, lifespan may vary. If damage to the leather is found, contact the place of purchase and replace it.

Controller / Cable
Wear and tear due to the frequency of use by customers, failure or damage caused by discretionary opening or dropping

Etc.
Additional charges may apply for massage chair location change or disassembling/ assembling due to customer's request.

Warranty Period

- 01 If a malfunction occurs while using the product, you can receive free service within a set period from the date of installation.
- 02 When used for shared facilities, business, or commercial use, warranty is separate/shortened.

Fees Applied

Fees apply for the following.

- 01 Problems due to liquids spilling within interior of product.
- 02 Broken or disabled parts due to excessive pressure.
- 03 Problems due to deformation or external defects caused by personal actions.
- 04 Problems due to not using parts or consumables provided by BODYFRIEND.
- 05 Malfunction due to incorrect use of operating voltage.
- 06 Problems caused by user disabling parts of the machine.
- 07 Problems caused by repairs conducted by non-BODYFRIEND technicians/employees.
- 08 Problems caused by natural disasters.
- 09 Failure to follow safety precautions listed in User Manual.
- 10 Problems caused by user's personal mistakes.
- 11 Problems caused by user's reckless behavior, inability to follow guidelines, and etc.
- 12 Problems with discoloration caused by continuous sunlight or exposure to ultraviolet rays.

Reasons for No Return and Exchange

As this product is an electronic product that requires installation, no return or exchange is allowed for the following reasons.

(When using after installation, the value of the product significantly decreases, so it cannot be sold as a new product)

- 01 No change of mind refunds (color, price change, etc.) or exchange is allowed.
- 02 If it is not a defect that requires a major repair of the product, it cannot be exchanged or returned after installation. (Warranty applies)
- 03 No exchange or return is allowed due to individual differences. (massage strength, body size, etc.) (Recommend product testing before purchase)

Warranty Terms And Conditions

Covered :

- All parts, labor, and framework of the chair
- Labor and parts covered for the first three years at no cost to Purchaser
- Structural Framework covered at no cost to Purchaser for all five years
- Defects in materials and workmanship

All goods sold hereunder, except accompanying accessories, documentations, or enhancements, are warranted to be free from defects in material and workmanship at the time of delivery to Purchaser and covered for the above, for a period of five (5) years from the date of delivery. Defective material may be returned to BODYFRIEND after inspection by an agent of BODYFRIEND and upon receipt from BODYFRIEND of shipping instructions specific to the defective goods authorized by BODYFRIEND to be returned. Goods returned in accordance with the foregoing procedure will be replaced or repaired, at the option of BODYFRIEND, and returned to Purchaser without charge. This warranty is subject to the following LIMITATIONS AND EXCLUSIONS :

Limitations :

- This express warranty applies to massage chairs ONLY, and not to accompanying accessories, documentation or enhancements;
- This warranty is non-transferable;
- This warranty is valid only within the continental US;
- BODYFRIEND's responsibility and Purchaser's exclusive remedy under this warranty is limited to the repair or replacement of defects in material and workmanship, as set forth above. BODYFRIEND is not responsible for any consequential damages resulting from the breach of this or any other express or implied warranty with respect to the goods;
- This express warranty is the only warranty applicable to this transaction. It excludes all other express oral or written warranties and all warranties implied by law with respect to the goods, including any warranties of merchantability or fitness for a particular purpose;
- This warranty does not extend to any of BODYFRIEND's products which have been subject to misuse, accident or improper installation or storage, maintenance or application, nor does it extend to products which have been repaired or altered outside of BODYFRIEND or its authorized agents, nor does this warranty extend to any labor charges for removal and/or replacement of the nonconforming or defective product or part thereof;
- Every claim under this warranty or related to this purchase order shall be deemed waived by Purchaser unless made in writing within five (5) years of the receipt of the goods to which such claim relates; AND
- This warranty is void in the event that repairs are made by anyone other than BODYFRIEND without prior authorization from BODYFRIEND.

The terms of this warranty shall be governed by the laws of the state of California.

Warranty Terms And Conditions

Exclusions :

This express warranty is void without this warranty card and requested information (date of purchase, installation, RMA, etc.).

This express warranty does not cover damage resulting from improper installation or use, neglect, dropped product, unreasonable maintenance, failure to follow instructions, unauthorized repairs, alterations, modifications of original condition, and cosmetic alternations. Furthermore, warranty does not cover damage resulting from improper use of electrical/power supply; loss of power; electrical disturbances, power surges.

Also, damage or cracked screen because of personal misuse, excessive force, transportation damage, theft, abuse, misuse, vandalism, or natural disasters (fires, floods, rust, corrosion, sand, dirt, windstorms, hail, earthquakes, or any exposure to weather conditions) are not covered under stated warranty.

BODYFRIEND does not honor warranty for products purchased by or through unauthorized dealers, product used commercially or for commercial purposes, and time lost by owner during the time the product is being replaced, at a repair facility, etc. Natural occurrences such as, but not limited to softening/hardening of foams and composites, fading, wear, pilling of fabrics, natural markings, grain and dye variations in leather, and failure of attach points does not validate issue of warranty, as well as items intended to be periodically replaced by Purchaser during the normal lifetime of a product including, but not limited to batteries, light bulbs, and etc. Seat cover replacement and other accessories are not covered under warranty.

Labor :

Only for the first three years of the warranty period (“Labor Service Period”), BODYFRIEND will provide labor services for the repair or replacement of defective parts at no cost to Purchaser. However, Purchaser is responsible for all shipping, duties, and brokerage fees.

Upon expiration of the Labor Service Period, Purchaser shall pay for any labor service charges. Labor services are limited to the replacement of the defective product or parts with a similar product of equal or less value. If replacement is not accepted by Purchaser, BODYFRIEND or its labor service provider is no longer responsible for further service under this labor warranty. If and only when deemed necessary at its sole discretion, BODYFRIEND will send a service provider at no cost. Field service is only available within the continental US and under the Labor Service Period. If no problem is found upon diagnosis, Purchaser may be charged with standard rate for unnecessary service calls.

*Listed years vary by product

BODYFRIEND
855-200-3524
service@bodyfriend.com

Memo

Memo

Medical care
PHANTOM

Medical Device

Model

BFR-M8040US

Manufacturers

Bodyfriend Co., Ltd.

Customer Support Contact Information

service@bodyfriend.com / 562-991-5546

Voltage/Frequency

110-120V~, 60HZ

User's Guide

02_BF_PHANTOMMEDICALCARE_Manual_Eng

Manual No.

220901

