

# Grandstream Networks, Inc.

---

DP750/DP720

User Guide



## **COPYRIGHT**

©2016 Grandstream Networks, Inc. <http://www.grandstream.com>

All rights reserved. Information in this document is subject to change without notice. Reproduction or transmittal of the entire or any part, in any form or by any means, electronic or print, for any purpose without the express written permission of Grandstream Networks, Inc. is not permitted.

The latest electronic version of this user manual is available for download here:

<http://www.grandstream.com/support>

Grandstream is a registered trademark and Grandstream logo is trademark of Grandstream Networks, Inc. in the United States, Europe and other countries.

## **CAUTION**

Changes or modifications to this product not expressly approved by Grandstream, or operation of this product in any way other than as detailed by this User Manual, could void your manufacturer warranty.

## **WARNING**

Please do not use a different power adaptor with your devices as it may cause damage to the products and void the manufacturer warranty.



## GNU GPL INFORMATION

DP750 firmware contains third-party software licensed under the GNU General Public License (GPL). Grandstream uses software under the specific terms of the GPL. Please see the GNU General Public License (GPL) for the exact terms and conditions of the license.

Grandstream GNU GPL related source code can be downloaded from Grandstream web site from:

[http://www.grandstream.com/sites/default/files/Resources/gpl\\_dp750.tar.gz](http://www.grandstream.com/sites/default/files/Resources/gpl_dp750.tar.gz)



# Table of Content

<b>DOCUMENT PURPOSE .....</b>	<b>8</b>
<b>CHANGE LOG .....</b>	<b>9</b>
Firmware Version 1.0.2.16 .....	9
Firmware Version 1.0.1.14 .....	9
Firmware Version 1.0.1.4 .....	10
Firmware Version 1.0.0.16 .....	10
<b>GUI INTERFACE EXAMPLES .....</b>	<b>11</b>
<b>WELCOME .....</b>	<b>12</b>
<b>PRODUCT OVERVIEW .....</b>	<b>13</b>
Feature Highlights .....	13
DP750 Technical Specifications .....	14
DP720 Technical Specifications .....	15
<b>GETTING STARTED .....</b>	<b>17</b>
Equipment Packaging .....	17
Connecting DP750 .....	18
<i>Connecting via AC power</i> .....	18
<i>Connecting via PoE</i> .....	18
Setting up DP720 handset .....	19
<i>Battery Information</i> .....	19
Setting up the Charge Station .....	20
DP750 LED Patterns .....	20
DP720 Handset Description .....	21
DP720 Icons Description .....	22
DP720 Handset Menu .....	25
<b>BASIC OPERATIONS .....</b>	<b>28</b>
Turning the Handset ON / OFF .....	28
Register DP720 Handset to DP750 Base Station .....	28
Using DP720 with multiple DP750 base stations .....	29
<i>Registering DP720 to an additional DP750 base station</i> .....	29
<i>Switching between different base stations</i> .....	30
Unregister the DP720 .....	31
Obtain DP750 Base Station IP Address via paired DP720 .....	31
Setting the Key Lock .....	32



Locating a DP720 Handset from DP750 Base station.....	32
<i>Locate via DP750 Web UI</i> .....	32
<i>Locate via DP750 Base station</i> .....	33
Checking System Status.....	33
Basic Network Settings.....	34
Register a SIP Account.....	35
<i>Register account via web user interface</i> .....	35
Return to Idle Screen.....	37
Change Menu and Backlight Timeout.....	37
<b>PHONE SETTINGS.....</b>	<b>38</b>
Editing the Handset's name.....	38
Changing the Base PIN Code.....	38
Selecting the Menu Language.....	39
Activate/Deactivate Hands-Free Mode.....	40
Muting the Microphone.....	40
Adjusting Speaker and Earpiece Volume.....	40
Ringtones.....	41
<i>Setting the Ringer Volume on the Handset</i> .....	41
<i>Setting the Ringer Melody on the Handset</i> .....	41
<i>Advisory Tones</i> .....	42
Date and Time.....	43
Outgoing Default Line.....	44
Factory Functions.....	44
Firmware Upgrade.....	45
Reboot DP750 Base Station.....	46
Reset DP720 Handset.....	46
<b>CALL OPERATIONS .....</b>	<b>47</b>
Placing calls.....	47
Make a Call using a Line.....	47
Dialing from Call history.....	48
Dialing from Phonebook.....	48
Answering Calls.....	49
Ending Calls.....	49
Rejecting Calls.....	49
Auto Answer.....	49
Direct IP Call.....	50
Call Hold/Resume.....	50
Call Waiting.....	50
Do Not Disturb.....	51
Call forward.....	51



Call transfer.....	52
<i>Blind Transfer</i> .....	52
<i>Attended Transfer</i> .....	52
Speed Dial .....	52
3-Way Conference .....	53
Voice Mail.....	53
<i>Set Voice mail feature code</i> .....	53
<i>Play voice mail messages</i> .....	53
Call Features.....	54
<b>RESTORE FACTORY DEFAULT SETTINGS .....</b>	<b>56</b>
<b>EXPERIENCING DP750/DP720 .....</b>	<b>57</b>

## Table of Tables

Table 1: DP750 Features in a Glance .....	13
Table 2: DP720 Features in a Glance .....	13
Table 3: DP750 Technical Specifications .....	14
Table 4: DP720 Technical Specifications .....	15
Table 5: Equipment Packaging .....	17
Table 6: DP750 Led Patterns .....	20
Table 7: Handset Keys Description .....	21
Table 8: DP720 Icons Descriptions .....	22
Table 9: DP720 Info description .....	33
Table 10: Call Features .....	54

## Table of Figures

Figure 1: DP720 Package Contents .....	17
Figure 2: DP750 Package Contents .....	17
Figure 3: DP750 Back View .....	18
Figure 4: Connecting the Base station .....	18
Figure 5: Setting up the DP720 .....	19
Figure 6: Setting up the charger station .....	20
Figure 7: Handset Keys Description .....	21
Figure 8: DP720 Menu Structure .....	25
Figure 9: DECT Status - Subscribe .....	28
Figure 10: Registration process .....	29
Figure 11: Multiple Base Stations Registration .....	30
Figure 12: Switching Between Base Stations .....	30
Figure 13: Locate Handset via Web UI .....	33
Figure 14: Network Settings configuration .....	34
Figure 15: SIP Settings .....	35
Figure 16: Sip Accounts Settings .....	36
Figure 17: Account Status .....	37
Figure 18: Handset Name editing .....	38
Figure 19: Changing Admin Base PIN Code .....	39
Figure 20: Handset Language .....	40
Figure 21: Ringer Volume .....	41
Figure 22: Calls Ringtones .....	42
Figure 23: Advisory Tone .....	43
Figure 24: Date and Time Settings .....	43
Figure 25: Factory Functions .....	45
Figure 26: New Firmware Available Notification .....	45
Figure 27: Firmware Upgrade .....	45
Figure 28: Rebooting the Base Station .....	46
Figure 29: Resetting the Base Station .....	46





## DOCUMENT PURPOSE

This document describes the basic concept and tasks necessary to use and configure your DP720 via the LCD menu and also using the DP750 base station. And it covers the handset installation, basic operations and call features. Please visit <http://www.grandstream.com/support> to download the latest “DP750/DP720 User Guide”.

This guide covers following topics:

- [Product Overview](#)
- [Getting Started](#)
- [Basic Operations](#)
- [Phone settings](#)
- [Call Operations](#)



## CHANGE LOG

This section documents significant changes from previous versions of user guide for DP750/DP720. Only major new features or major document updates are listed here. Minor updates for corrections or editing are not documented here.

### Firmware Version 1.0.2.16

- Re-arranged the Handset Menu Settings. [DP720 Handset Menu]
- Changed menu “Line Status” in Call Settings to “Lines”. [Lines]
- Changed menu “Number” in set voice Mail to “VM Access Number”.
- Added headset detection and icon for DP720 dial mode screen. [DP720 Icons Description]
- Added ability to bridge conference before third party answers. [3-Way Conference]
- Added ability to reboot from DP720 handset. [Reboot DP750 Base Station]
- Improved alarm snooze icon. [DP720 Icons Description]
- Added DP720 LCD auto turn on feature when pickup from or reposition to charger.
- Added + button support for keypad dialing. [DP720 Handset Description] [Make a Call using a Line]
- Added Serbian, Slovakian languages.
- Improved support for Czech, Dutch, German, Hebrew, Japanese, Korean, Turkish languages

### Firmware Version 1.0.1.14

- Added snooze time settings for alarm function. [Alarm Settings]
- Added snooze icon. [DP720 Icons Description]
- Updated alarm icon. [DP720 Icons Description]
- Removed IVR (Interactive Voice Response).
- Added contact name to delete confirmation.
- Added use Line from Contacts when dialing out of phonebook. [Dialing from Phonebook]
- Added VM, missed calls, headset icon. [DP720 Icons Description]
- Removed “Intercom” feature.
- Removed “Internal Call” from audio ring tone menu.
- Adjusted Call History and Contacts menu architecture. [DP720 Handset Menu]
- Moved "Edit Dial" option to last one in Call History and Contacts menu option. [Dialing from Call history] [Dialing from Phonebook]
- Hide empty fields when displaying contact info.
- Hide icon after press back key in idle misses call or VM alert screen.
- Moved “Standard ring” to last one of ring tone list. [Ringtones]
- Missed Call can be dialed back via related SIP profile using softkey.[Dialing from Call history]



### **Firmware Version 1.0.1.4**

- Added Call and Delete softkeys during off-hook dial. [Placing calls]
- Added left softkey for Voice mail alert window to enter the Play Message window. [Play voice mail messages]
- Added Display line name info immediately after off-hook. [Placing calls]
- Changed to only press ESC key to show factory menu.
- Added Dial number immediately after off-hook.
- Added Dialing GUI enhancements.
- Added ability to configure menu key timeout. [Change Menu and Backlight Timeout]
- Added Handset will prompt “Saved successfully” if configuring call forward settings in ring group.
- Added advisory tone for handset put in and out of cradle.
- Added ability to configure menu key timeout.
- Added when last name is none use the first name for speed dial record name.
- Added when handset enter IVR, press RSK hold key will delete dial number.
- Added stop dial tone if first key not number key after off hook

### **Firmware Version 1.0.0.16**

- This is the initial version for DP750/DP720.



## GUI INTERFACE EXAMPLES

[http://www.grandstream.com/sites/default/files/Resources/dp750\\_web\\_gui.zip](http://www.grandstream.com/sites/default/files/Resources/dp750_web_gui.zip)

1. Screenshot of Login Page
2. Screenshots of Status Pages
3. Screenshots of Profiles Pages
4. Screenshots of DECT Pages
5. Screenshots of Phonebook Pages
6. Screenshots of Settings Pages
7. Screenshots of Maintenance Pages



## **WELCOME**

Thank you for purchasing Grandstream DP720 DECT IP Phone, the DP720 is the next generation of versatile, affordable, high quality and easy-to-use, high quality DECT cordless IP phones for small business and residential users. These compact and durable DECT IP phones allow users mobility throughout their home or office while maintaining the benefits of VoIP calling with a reliable and convenient wireless voice communications. Moreover, it provides many widely accepted benefits of the DECT standard, including compact size, superb HD audio quality, rich feature set, market leading price-performance and wide range radio coverage which allow users to enjoy the benefits of mobility for a minimum investment



## PRODUCT OVERVIEW

### Feature Highlights

The following tables contain the major features of the DP750 / DP720:

<p style="text-align: center;"><b>DP750</b></p> 	<ul style="list-style-type: none"> <li>• 5 handsets.</li> <li>• 10 accounts.</li> <li>• 10 lines.</li> <li>• 4 concurrent calls.</li> <li>• PoE power support.</li> <li>• 300m range outdoor / 50m range indoor.</li> </ul>
---	---

**Table 1: DP750 Features in a Glance**

<p style="text-align: center;"><b>DP720</b></p> 	<ul style="list-style-type: none"> <li>• DECT cordless HD.</li> <li>• 1.8 inch (128x160) TFT color LCD.</li> <li>• 250 hours standby / 20 hours talk time.</li> <li>• 15 languages embedded.</li> <li>• 10 accounts.</li> <li>• 10 lines.</li> <li>• 5 ring modes.</li> </ul>
---	---

**Table 2: DP720 Features in a Glance**



## DP750 Technical Specifications

The following table resumes all the technical specifications including the protocols / standards supported, voice codecs, telephony features, languages and upgrade/provisioning settings for the Base station DP750.

**Table 3: DP750 Technical Specifications**

<b>Air Interface</b>	<b>Telephony standards:</b> DECT <b>Frequency bands:</b> <ul style="list-style-type: none"> <li>▪ 1880 – 1900 MHz (Europe), 1920 – 1930 MHz (US)</li> <li>▪ 1910 – 1920 MHz (Brazil), 1786 – 1792 MHz (Korea)</li> <li>▪ 1893 – 1906 MHz (Japan), 1880 – 1895 MHz (Taiwan)</li> </ul> <b>Number of channels:</b> 10 (Europe), 5 (US, Brazil or Japan), 3 (Korea), 8 (Taiwan) <b>Range:</b> up to 300 meters outdoor and 50 meters indoor
<b>Peripherals</b>	5 LED indicators: Power, Network, Register, Call, DECT Reset button, Pairing/Paging button One 10/100 Mbps auto-sensing Ethernet port with integrated PoE
<b>Protocols/Standards</b>	SIP RFC3261, TCP/IP/UDP, RTP/RTCP, HTTP/HTTPS, ARP/RARP, ICMP, DNS (A record, SRV, NAPTR), DHCP, PPPoE, SSH, TFTP, NTP, STUN, SIMPLE, LLDP-MED, LDAP, TR-069, 802.1x, TLS, SRTP, IPv6 (pending)
<b>Voice Codecs</b>	G.711 $\mu$ /a-law, G.723.1, G.729A/B, G.726-32, iLBC, G.722, OPUS, G.722.2/AMR-WB (special order), in-band and out-of-band DTMF (in audio, RFC2833, SIP INFO), VAD, CNG, PLC, AJB
<b>Telephony Features</b>	Hold, transfer, forward, 3-way conference, downloadable phonebook (XML, LDAP, up to 3000 entries), call waiting, call log (up to 300 records), auto answer, flexible dial plan, music on hold, server redundancy and fail-over
<b>Sample Applications</b>	Currency (pending)
<b>QoS</b>	Layer 2 QoS (802.1Q, 802.1p) and Layer 3 QoS (ToS, DiffServ, MPLS)
<b>Security</b>	User and administrator level access control, MD5 and MD5-sess based authentication, 256-bit AES encrypted configuration file, TLS, SRTP, HTTPS, 802.1x media access control, DECT authentication & encryption
<b>Multi-language</b>	English, Czech, German, Spanish, French, Hebrew, Nederlands, Japanese, Chinese Simple, Chinese Tradition, Korean, Portuguese, Slovakian, Serbian, Turkish.
<b>Upgrade/Provisioning</b>	Firmware upgrade via TFTP/HTTP/HTTPS, mass provisioning using TR-069 or AES encrypted XML configuration file
<b>Multiple SIP Accounts</b>	Up to ten (10) distinct SIP accounts per system <b>Each handset</b> may map to any SIP account(s) <b>Each SIP account</b> may map to any handset(s)



<b>Ring Group</b>	Flexible options when multiple handsets share the same SIP account <ul style="list-style-type: none"> <li>▪ <b>Circular Mode:</b> all phones ring sequentially, starting with the phone after the one which rang last.</li> <li>▪ <b>Linear Mode:</b> all phones ring sequentially in the predetermined order, starting with the first phone each time.</li> <li>▪ <b>Parallel Mode:</b> all phones ring concurrently; after one phone answers, the remaining available phones can make new calls</li> <li>▪ <b>Shared Mode:</b> all phones ring concurrently and always share the same line (similar to analog phones).</li> </ul>
<b>Power &amp; Green Energy Efficiency</b>	Universal Power Supply Input AC 100-240V 50/60Hz; Output 5VDC, 1A; Micro-USB connection; PoE: IEEE802.3af Class 1, 0.44W–3.84W
<b>Package Content</b>	Base unit, Universal Power Supply, Ethernet cable, Quick Start Guide, GPL Statement
<b>Dimensions</b>	28.5 mm (H) x 130 mm (W) x 90 mm (D)
<b>Weight</b>	Base unit: 143g, Universal Power Supply: 50g; Package: 360g
<b>Temperature and Humidity</b>	Operation: -10° to 55°C (14 to 131°F); Storage: -20° to 60°C (-4 to 140°F); Humidity: 10% to 90% non-condensing
<b>Compliance</b>	FCC: Part 15D, 47 CFR 2.1093, Part 15B CE: EN60950; EN301489-1-6; EN301406 RCM: AS/NZS60950 (Pending)

## DP720 Technical Specifications

The following table resumes all the technical specifications including the protocols / standards supported, voice codecs, telephony features, languages and upgrade/provisioning settings for the DP720 handset.

**Table 4: DP720 Technical Specifications**

<b>Air Interface</b>	<b>Telephony standards:</b> DECT <b>Frequency bands:</b> <ul style="list-style-type: none"> <li>▪ 1880 – 1900 MHz (Europe), 1920 – 1930 MHz (US)</li> <li>▪ 1910 – 1920 MHz (Brazil), 1786 – 1792 MHz (Korea)</li> <li>▪ 1893 – 1906 MHz (Japan), 1880 – 1895 MHz (Taiwan)</li> </ul> <b>Number of channels:</b> 10 (Europe), 5 (US, Brazil or Japan), 3 (Korea), 8 (Taiwan) <b>Range:</b> up to 300 meters outdoor and 50 meters indoor
<b>Peripherals</b>	1.8 inch (128x160) color TFT LCD 23 keys including 2 softkeys, 5 navigation / menu keys, 4 dedicated function keys for SEND, POWER/END, SPEAKERPHONE, MUTE 3-color MWI LED 3.5mm headset jack Removable belt clip Micro-USB port for alternative charging and non-battery operation





<b>Protocols/Standards</b>	Hearing Aid Compatibility (HAC) compliant
<b>Voice Codecs</b>	G.722 codec for HD audio and G.726 codec for narrow band audio (G.711 $\mu$ /a-law, G.723.1, G.729A/B, iLBC and OPUS are supported via companion DECT base station DP750), AEC, AGC, Ambient noise reduction
<b>Telephony Features</b>	Hold, transfer, forward, 3-way conference, call park, call pickup, downloadable phonebook, call waiting, call log, auto answer, click-to-dial, flexible dial plan, music on hold
<b>Sample Applications</b>	Currency (pending)
<b>HD Audio</b>	Yes, in both Handset and Speakerphone modes
<b>Security</b>	DECT authentication & encryption
<b>Multi-language</b>	English, Czech, German, Spanish, French, Hebrew, Nederlands, Japanese, Chinese Simple, Chinese Tradition, Korean, Portuguese, Slovakian, Serbian, Turkish.
<b>Upgrade/ Provisioning</b>	Software Upgrade Over-The-Air (SUOTA), handset provisioning Over-The-Air
<b>Multiple Line Access</b>	Each handset may access up to 10 lines
<b>Power &amp; Green Energy Efficiency</b>	Universal Power Supply Input AC 100-240V 50/60Hz; Output 5VDC 1A; Micro-USB connection; Rechargeable 800mAh Ni-MH Low Self-Discharge (LSD) AAA batteries (250 hours of standby time and 20 hours of talk time)
<b>Package Content</b>	Handset unit, universal power supply, charger cradle, belt clip, 2 batteries, Quick Start Guide
<b>Dimensions (H x W x D)</b>	Handset: 155 x 50 x 26 mm, charger cradle: 35 x 63.5 x 54 mm
<b>Weight</b>	Handset: 138g, charger cradle: 71g, universal power supply: 50g; Package: 360g
<b>Temperature and Humidity</b>	Operation: -10 <sup>o</sup> to 50 <sup>o</sup> C (14 to 122 <sup>o</sup> F); Charging: 0 to 45 <sup>o</sup> C (32 to 113 <sup>o</sup> F); Storage: -20 <sup>o</sup> to 60 <sup>o</sup> C (-4 to 140 <sup>o</sup> F); Humidity: 10% to 90% non-condensing
<b>Compliance</b>	FCC: Part 15D; 47 CFR 2.1093 & IEEE1528-2013, Part68, Part 15B CE: EN60950; EN301489-1-6; EN301406; EN50360; EN62209-1 RCM: AS/NZS60950; AS/ACIF S040; AS/ACIF S004; AS/CA S004:2013 (Pending)



## GETTING STARTED

This chapter provides basic installation instructions including the list of the packaging contents and also information for obtaining the best performance with the DP720 IP DECT phone and its base station DP750.

### Equipment Packaging

Table 5: Equipment Packaging

DP720	DP750
<ul style="list-style-type: none"> <li>• 1 Handset unit</li> <li>• 1 Universal power supply 5V</li> <li>• 1 Charger cradle</li> <li>• 1 Belt clip</li> <li>• 2 Chargeable batteries</li> <li>• 1 Quick start guide</li> </ul>	<ul style="list-style-type: none"> <li>• 1 Base unit</li> <li>• 1 Universal power supply 5V</li> <li>• 1 Ethernet cable</li> <li>• 1 Quick start guide</li> <li>• 1 GPL Statement</li> </ul>



Figure 1: DP720 Package Contents



Figure 2: DP750 Package Contents

**Note:** Check the package before installation. If you find anything missing, contact your system administrator.

## Connecting DP750

To setup the DP750 base station, please follow the steps below:

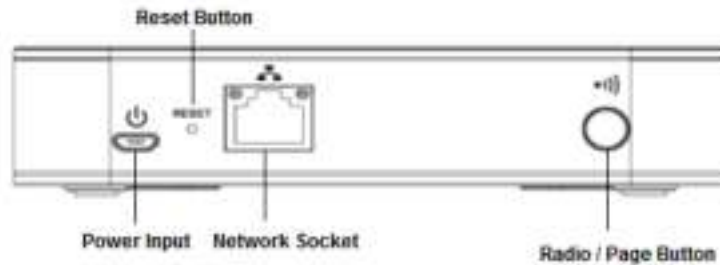

Figure 3: DP750 Back View

You have two options for power and network connection of the base station: AC power or Power over Ethernet (PoE)

### Connecting via AC power

1. Connect the micro-USB connector into the related port on the base station and connect the other end of the power adapter into an electrical power outlet.
2. Connect the supplied Ethernet cable between the internet port on the base station and the internet port in your network or the switch/hub device port.

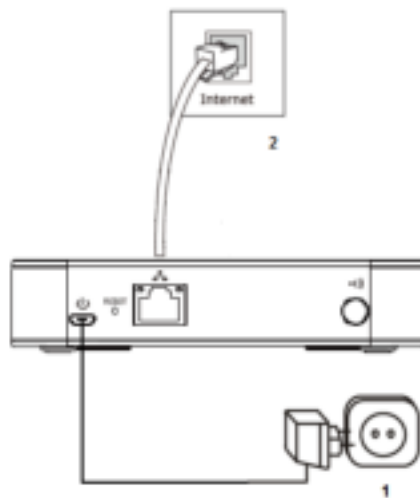

Figure 4: Connecting the Base station

### Connecting via PoE

To connect the base station using the POE, you need to connect the Ethernet cable provided (or 3rd party network cable) between the network socket on the base station to Ethernet port of the POE switch/hub.



## Setting up DP720 handset

Please follow below steps to insert batteries into the handset:

1. Open the battery compartment cover.
2. Insert the batteries in the correct polarity.
3. Close the battery compartment cover.

**Note:** Please charge the batteries fully before using the handset for the first time

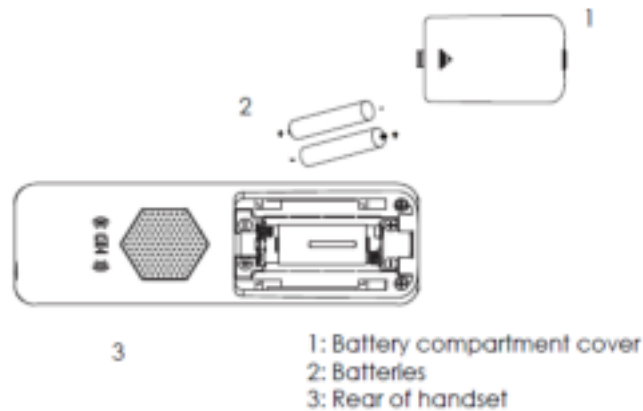

Figure 5: Setting up the DP720

## Battery Information

- **Technology:** Nickel Metal Hydride (Ni-MH)
- **Size:** AAA
- **Voltage:** 1.2V
- **Capacity:** 800mAh
- **Charging time:** 12 hours from empty to full
- **Standby time:** up to 250 hours
- **Talk time:** up to 20 hours active talk time

In order to get the best performance of your DP720 handset, we recommend using original batteries provided in the package or batteries compliant with above specifications.

The specifications may differ depending on the age and capacity of the batteries used.

**Important Note:** Be careful when inserting the batteries into your handset to avoid any risk of short-circuits which lead to damage your batteries and/or the handset itself. Do not use damaged battery which can increase the risk of serious harm.



## Setting up the Charge Station

Please refer to the following steps for setting up the charge station and charging the handset:

1. Connect the DC plug on the power adapter to the micro-USB connector on the charge station.
2. Connect the other end of the power adapter into an electrical power outlet.
3. After setting up the handset and charger station, place the handset in the charger station.







Figure 6: Setting up the charger station

## DP750 LED Patterns

The DP750 has 5 LED lights on it. Please see on the following table the meaning of each light.



Table 6: DP750 Led Patterns

LED Light	Status
	Indicates power ON/OFF
	Indicates access to the Network. Remains ON while there is Access to the Network
	Indicates if a SIP account is registered
	Indicates status of the lines. <b>Blinking:</b> A line is in use. <b>Solid ON:</b> All lines are free.
	The radio icon for pairing the DP720 and DP750, if we keep pressing the radio button it starts blinking indicating pairing attempt.



## DP720 Handset Description

The LCD screen and the keypad are the main hardware components of the DP720.

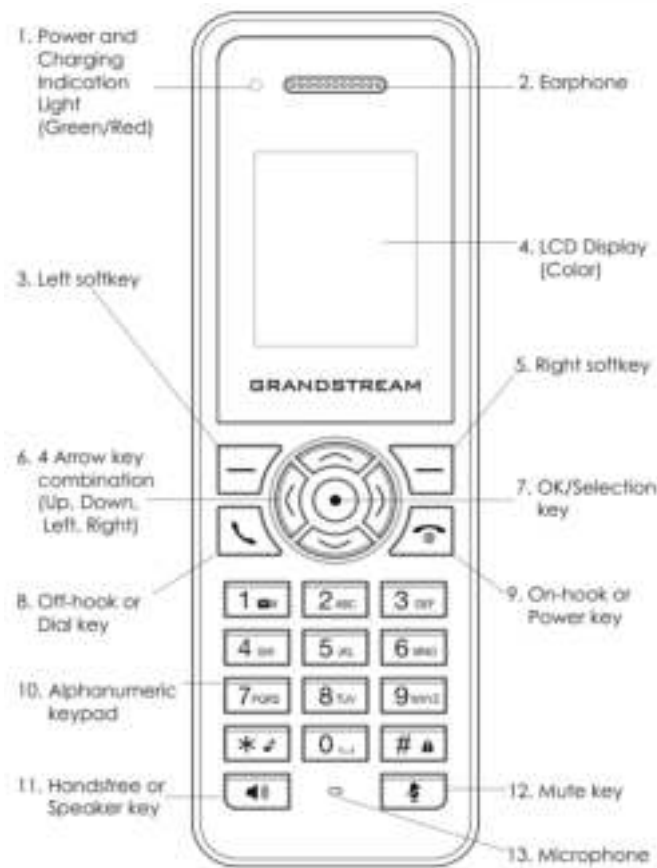

Figure 7: Handset Keys Description

Table 7: Handset Keys Description

	Key	Description
1.	<b>Power and Charging Indication Light</b>	<b>Red:</b> Charging. <b>Green:</b> Charge completed. <b>Blinking:</b> Missed call(s) or Voice Mail received.
2.	<b>Earphone</b>	Delivers audio output.
3,5	<b>Left and right softkeys</b>	Correspond to functions displayed on the LCD. These functions change depending on the current context.
4.	<b>LCD display</b>	Shows call information, handset status icons, prompt messages, etc.
6.	<b>4 Arrow key combination</b>	Permits navigation of the cursor through the displayed menu options.
7.	<b>OK/Selection key</b>	Selects the option chosen by the cursor. (Enters the main menu from the home screen.)
8.	<b>Off-hook / Dial key</b>	Enters dialing mode, or dials number entered.













<b>9.</b>	<b>On-hook / Power key</b>	Terminates calls, or turns the handset on / off.
<b>10.</b>	<b>Alphanumeric Keypad</b>	Provides the digits, letters, and special characters in context-sensitive applications. For + sign, press and hold key 0.
<b>11.</b>	<b>Hands-free / Speaker key</b>	Switches between handset and hands-free / speaker modes.
<b>12.</b>	<b>Mute key</b>	Activates or deactivates the mute feature.
<b>13.</b>	<b>Microphone</b>	Picks up audio earpiece and hands-free calls.



















## DP720 Icons Description

The following table contains the description of each icon that might be displayed on the screen of DP720.

**Table 8: DP720 Icons Descriptions**





	<b>Alarm</b> Alarm icon. The icon shows when set alarm.
	<b>Snooze</b> Snooze icon. The icon shows when set snooze.
	<b>Battery status</b> Not equipped with battery
	<b>Battery status</b> Battery empty
	<b>Battery status</b> Battery low
	<b>Battery status</b> Battery normal
	<b>Battery status</b> Battery full
	<b>Battery status</b> Charging
	<b>Signal status</b> Not subscribed
	<b>Signal status</b> Not in range
	<b>Signal status</b> Signal very low



	<b>Signal status</b> Signal low
	<b>Signal status</b> Signal normal
	<b>Signal status</b> Signal good
	<b>Signal status</b> Signal very good
	<b>Microphone MUTE Status</b> OFF - Not muted ON – Muted
	<b>Speaker status</b> OFF - Speaker is inactivated ON - Speaker is activated
	<b>Headset icon</b>
	<b>Missed Call icon</b>
	<b>Voicemail icon</b>
	<b>Ringtone status</b> OFF - Ringtone off (Silent mode) ON - Ringtone on
	<b>Keypad Lock status</b> OFF - Keypad unlock ON - Keypad locked
	<b>Incoming Call notification</b>
	<b>Outgoing Call notification</b>
	<b>Missed Call notification</b>
	<b>Incoming Call notification</b>
	<b>Outgoing Call notification</b>
	<b>Voicemail notification</b>
	<b>Contacts</b>





	<b>Call History</b>
	<b>Voice Mail</b>
	<b>Settings</b>
	<b>Call Settings</b>
	<b>Tools</b>



## DP720 Handset Menu

The handset has an easy-to-use menu structure. Every menu opens a list of options. To open the main menu, press “Menu” (left softkey) when the handset is on and in standby mode. Press Arrow keys to navigate to the menu option you require. Then press “Select” (left softkey) or **OK/Selection key** to access further options or confirm the setting displayed. To go to the previous menu item, press “Back” (right softkey). You can press **Power** key at any time to cancel and return to standby mode. If you do not press any key, the handset automatically reverts to standby mode after 20 seconds.

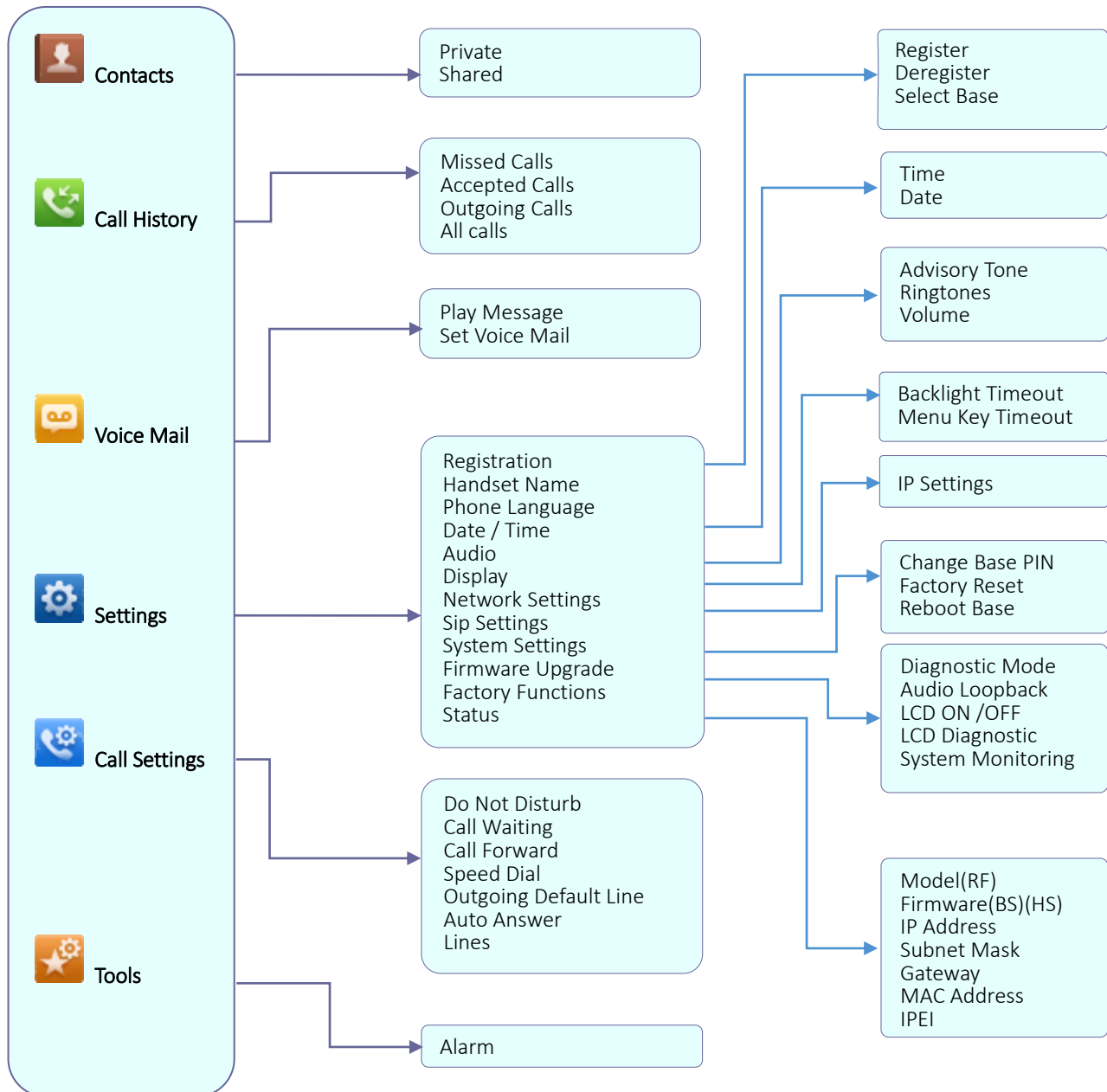

**Figure 8: DP720 Menu Structure**



<b>Contacts</b>	<ul style="list-style-type: none"> <li>• <b>Private:</b> Private contacts include contacts visible in the current handset only. You can add, edit, delete, and call all the entries in private contacts.</li> <li>• <b>Shared:</b> Shared contacts are the contacts shared between the handsets subscribed to the DP750 base station. You can add, edit, delete, edit and call all the entries in shared contacts as well.</li> </ul>
<b>Call History</b>	Display the call history: <b>Missed Calls</b> , <b>Accepted Calls</b> , <b>Outgoing Calls</b> or <b>All Calls</b> . You can add contacts to <b>Shared Contacts</b> directly from call logs.
<b>Voice Mail</b>	<ul style="list-style-type: none"> <li>• <b>Play Message:</b> Play the voice mail messages received.</li> <li>• <b>Set Voice Mail:</b> Configure the voice mail parameters.</li> </ul>
<b>Settings</b>	<ul style="list-style-type: none"> <li>• <b>Registration</b> Register and unregister your handset and also search for base station.</li> <li>• <b>Handset Name</b> Change the handset's name.</li> <li>• <b>Phone Language</b> Select the language to be displayed on the phone's LCD. (Default is English.)</li> <li>• <b>Date/Time</b> Configure date and time on the handset.</li> <li>• <b>Audio</b> Specify ringtones for incoming calls, the volume, and advisory tones (keypad, confirmation, low battery notifications).</li> <li>• <b>Display</b> Configure backlight timeout.</li> <li>• <b>Network Settings</b> Configure IP addresses and select DHCP/Static IP mode.</li> <li>• <b>SIP Settings</b> Configure/View SIP accounts settings.</li> <li>• <b>System settings</b> Change base PIN code; Perform factory reset.</li> <li>• <b>Firmware Upgrade</b> Upgrade the firmware version of the handset.</li> <li>• <b>Factory Functions</b> <ul style="list-style-type: none"> <li>- <i>Diagnostic Mode</i> All LEDs will light up, and the LCD will display a table listing the names of all keys in red. Press any key to diagnose; the key's name will display in blue. After all keys are diagnosed, a prompt message ("PASS") will display; press "Back" (right softkey) to exit.</li> <li>- <i>Audio Loopback</i> Speak to the phone using speaker/handset/headset. If you can hear</li> </ul> </li> </ul>



	<p>your voice, your audio is working fine. Press “Exit” softkey to exit audio loopback mode.</p> <ul style="list-style-type: none"> <li>- <i>LCD ON / OFF</i> Select this option to turn off LCD. Press any button to turn on LCD.</li> <li>- <i>LCD Diagnostic</i> Select this option to enter LCD Diagnostic mode. Press “Next” (left softkey) to display white screen. Continue pressing the left softkey to view all remaining screens (black, blue, red, and green) and then exit. End the test early by pressing the right softkey.</li> <li>- <i>System Monitoring</i> Displays the RSSI and battery voltage information.</li> </ul> <ul style="list-style-type: none"> <li>• <b>Status</b> Display the handset status (Firmware, Model, Hardware, IPEI ...)</li> </ul>
<b>Call Settings</b>	<ul style="list-style-type: none"> <li>• <b>Do Not Disturb</b> Enable/disable do not disturb mode on the phone.</li> <li>• <b>Call Waiting</b> Configure call waiting feature.</li> <li>• <b>Call Forward</b> Configure call forward feature.</li> <li>• <b>Speed Dial</b> Assign the numbers for speed dial.</li> <li>• <b>Outgoing Default Line</b> Select outgoing default line.</li> <li>• <b>Auto Answer</b> Enable/disable auto answer feature.</li> <li>• <b>Lines</b> Display the line status.</li> </ul>
<b>Tools</b>	<ul style="list-style-type: none"> <li>• <b>Alarm</b> <ul style="list-style-type: none"> <li>- <i>Set Alarm:</i> Configure the alarm</li> <li>- <i>Alarm Settings:</i> Configure Alarm Settings (Alarm Volume, Alarm Tone, Snooze Time)</li> </ul> </li> </ul>



## BASIC OPERATIONS

### Turning the Handset ON / OFF

#### To turn ON the handset

- Long press on **Power key**  until the LCD screen lights up.

#### To turn OFF the handset

- Long press on **Power key**  again when the handset is idle until the display turns off.

### Register DP720 Handset to DP750 Base Station

1. On DP750 Base station, press and hold the Radio/Page button for 7 seconds until the Radio icon starts blinking to start the subscription process. Or Access web UI, go to **Status >DECT Status** and press **Subscribe** button to **Open Subscription**.

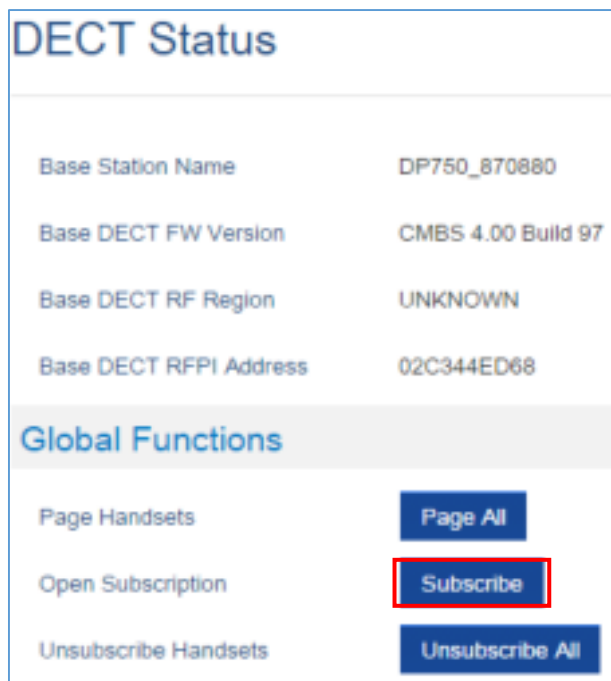





Figure 9: DECT Status - Subscribe

2. On DP720, Press “Menu” (left softkey  or the selection key  ) to bring up operation menu.
3. Press **Arrow keys** to move the cursor to **Settings** and navigate to **Registration**, then press “Select” (left softkey ).



4. Navigate to **Register**, then press “Select” while the DP750 Radio icon is blinking.
5. Select **BaseX** (X=1-4) corresponding to the desired base station DP750, then press **Subscribe**.
6. The DP720 will search for nearby base stations and will display the RFPI code and base station name of the discovered DP750.
7. Press **Subscribe** to pair with the displayed DP750.
8. The DP720 will display **Easy Pairing** on the LCD and play an audible buzz when successful. Then it will return to the home screen, displaying the handset name and number assigned by the registered base station.

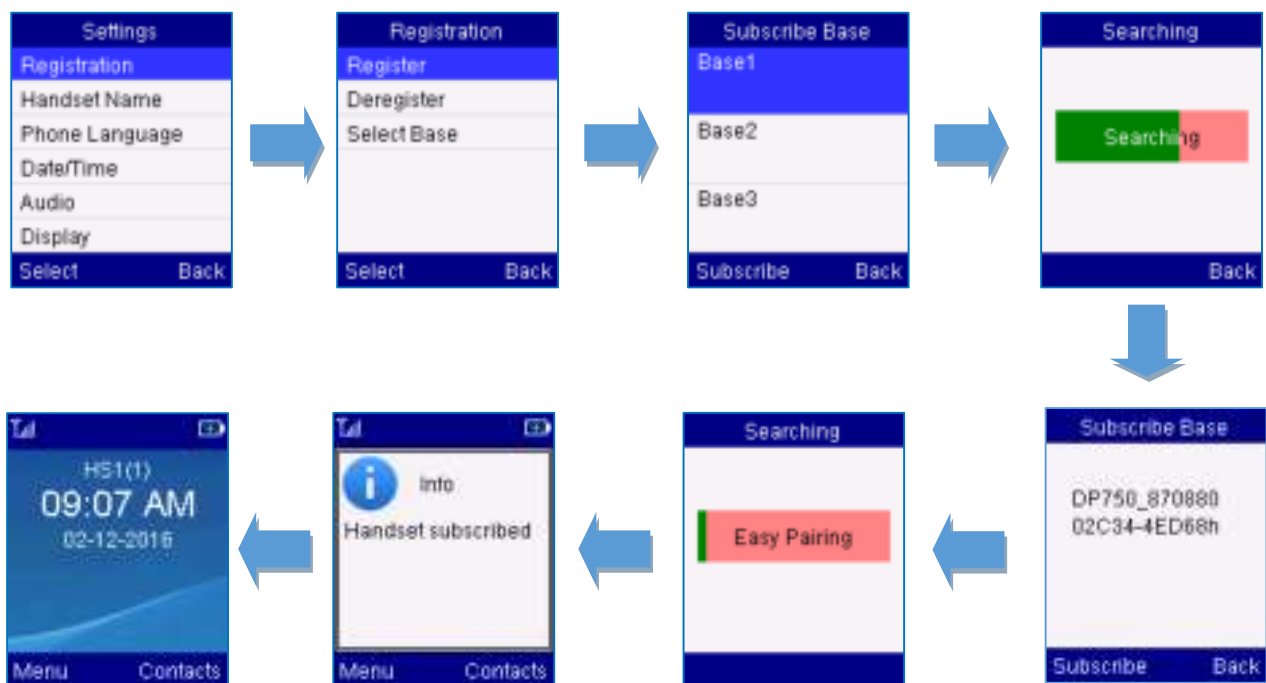





Figure 10: Registration process

## Using DP720 with multiple DP750 base stations

DP720 handset can be registered with up four different DP750 base stations.

### Registering DP720 to an additional DP750 base station

Considering DP720 is previously registered to an initial base station, please follow below steps to register a handset to an additional base station:

1. Press **Menu** (left softkey  or the selection key  ) to bring up operation menu.
2. Use arrow keys to reach **Settings**  and select **Registration**.



3. Select **Register**.
4. Navigate to an unsubscribed Base using arrow keys, and click on **Subscribe**.
5. Make sure that the subscription is opened on the new base station.

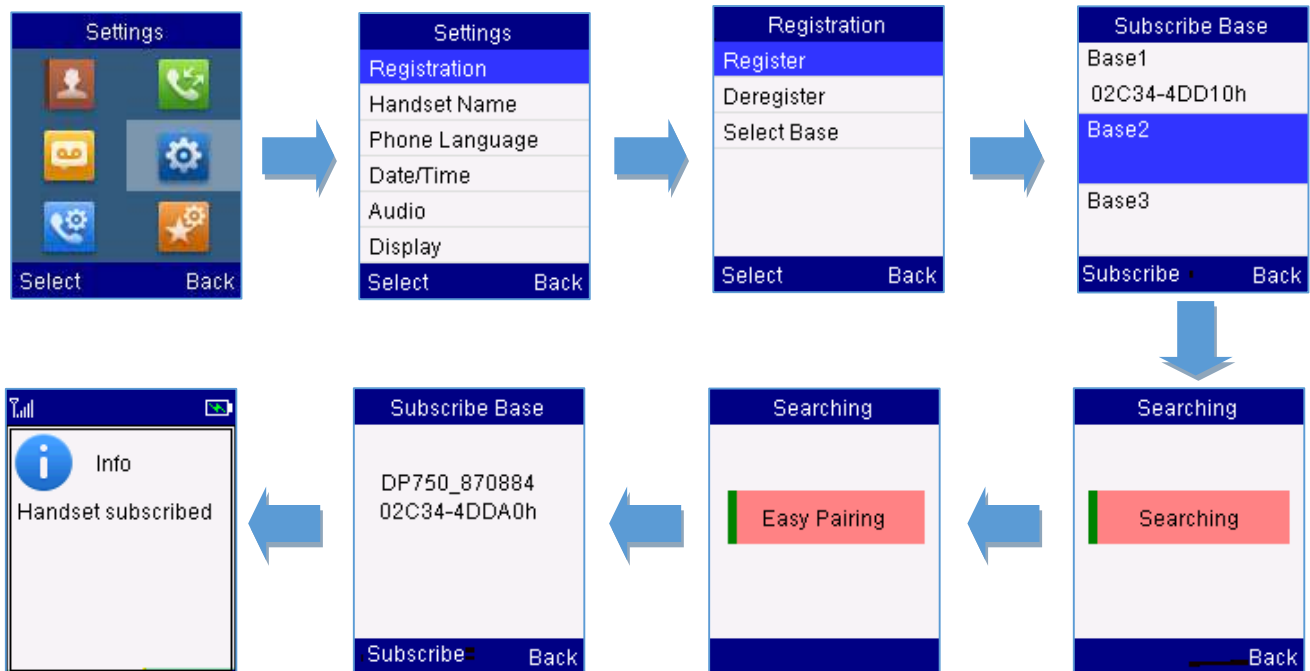





Figure 11: Multiple Base Stations Registration

### Switching between different base stations

1. Press **Menu** (left softkey  or the selection key  ) to bring up operation menu.
2. Use arrow keys to reach **Settings**  .
3. Select **Registration**.
4. Navigate to **Select Base** using arrow keys.
5. Select the desired base station and press **Select**.

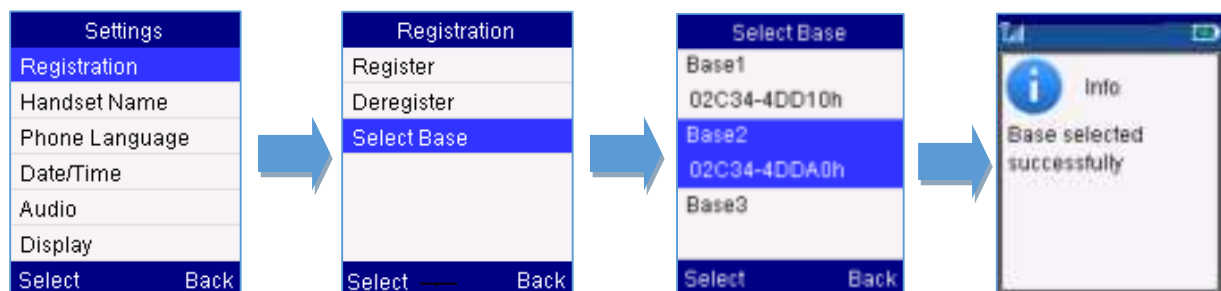







Figure 12: Switching Between Base Stations







## Unregister the DP720

1. On DP720, press “Menu” (left softkey  or the selection key  ) to bring up operation menu.
2. Press arrow keys to move the cursor to **Settings** and then press “Select”.
3. Navigate to **Registration**, then press “Select” (left softkey  ).
4. Navigate to **Deregister**.
5. Select the Handset to be unregistered and press “Deregister” (left softkey  ).
6. Enter the system PIN code (default: 0000).
7. Press “Done” (left softkey  ) to confirm or “Back” (right softkey  ) to cancel.

## Obtain DP750 Base Station IP Address via paired DP720

DP750 is by default configured to obtain IP address from DHCP server where the unit is located. In order to know which IP address is assigned to your DP750, please follow below steps using a paired DP720 handset with your DP750 base station.

Please see [Register DP720 Handset to DP750 Base Station](#)

1. Press **Menu** (left softkey  or the selection key  ) to bring up operation menu.
2. Press Arrow (Up, Down, Left, Right) keys to move the cursor to **Settings**  , then press “Select” (left softkey  ).
3. Press up arrow key to navigate to **Status**, then press “Select”.



4. The LCD screen will display information about the DP720.
5. Using arrow keys, navigate down to view the IP address of the DP750.







## Setting the Key Lock

You can lock the keypad against unintentional entries. It is, however, still possible to pick up incoming calls even with the keypad locked.

### • To enable the Keypad Lock

1. Press the **Pound key “#”**  and hold for approximately 2 seconds.
2. The display shows Keypad Locked briefly and the key lock icon  appears in the display.

### • To disable the Keypad Lock

1. Press and hold **Pound key “#”**  to unlock the keys.
2. Keypad Unlocked appears briefly in the display and a windows prompt will be displayed to confirm that the keypad is unlocked.

## Locating a DP720 Handset from DP750 Base station

In some situations, you may have a DP720 handset incorrectly positioned and you don't know its current location. You can locate a DP720 handset from his registered DP750 base station using below steps:

### Locate via DP750 Web UI

1. Access your DP750 base station web UI by entering its IP address in your favorite browser.
2. Enter your admin's username and password (default username and password: admin/admin).
3. Press **Login** to access your settings.
4. Go to **Status > DECT Status** tab.
5. Choose which handset to locate and press its corresponding **Page** button.
6. A paging call will be received on the selected DP720 handset.

If you press **Page All**, all registered DP720 handsets will be receiving paging call.

7. Once located, you can press any key on the handset or press **Page** or **Page All** to end paging call.



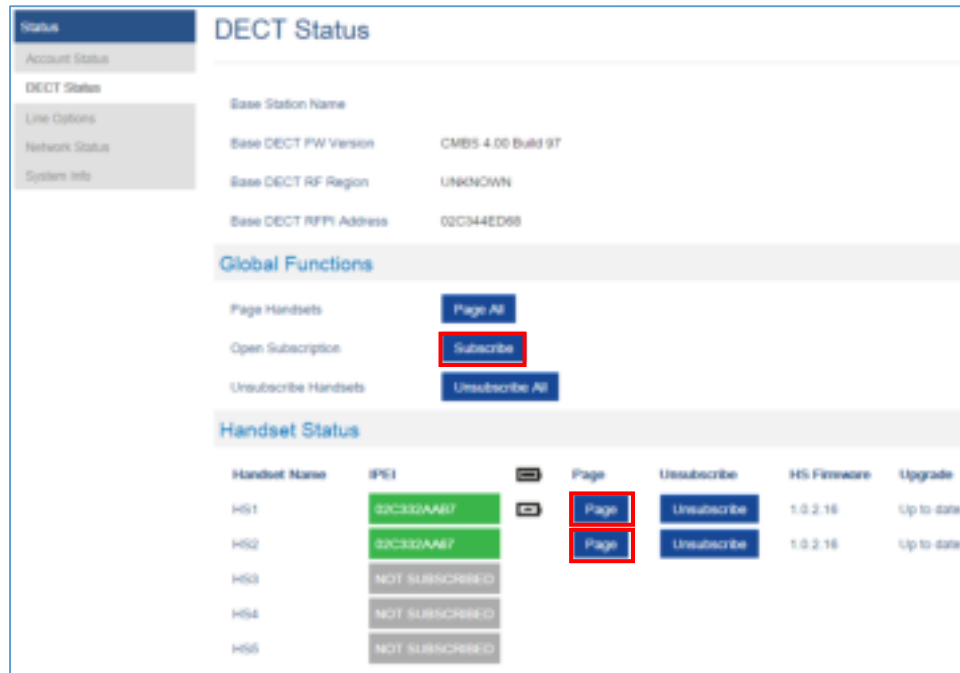



Figure 13: Locate Handset via Web UI

### Locate via DP750 Base station

1. On DP750 Base station back side, press **Radio/Page** button .
2. All registered handsets will receive paging call, once located, you can terminate the paging calling by pressing any key on the handsets or the radio/page button again.

### Checking System Status



You can view the system status on your handset including the following information of the system:

Table 9: DP720 Info description

Item	Description
<b>Model</b>	Product model info. <b>DP720</b>
<b>Firmware</b>	Current firmware version installed on DP720. i.e.: 1.0.2.4
<b>Hardware</b>	Hardware version of DP720. i.e.: 1.4A
<b>IPEI</b>	International Portable Equipment Identifier. Unique “serial number” for DECT handsets.
<b>DECT Region</b>	Region of DECT. i.e. EU or US
<b>IP Address</b>	IP address of the base station DP750 if registered.
<b>Subnet Mask</b>	Subnet Mask of the base station DP750 if registered.
<b>Gateway</b>	Gateway IP of the base station DP750 if registered.
<b>MAC address</b>	MAC address of the base station DP750 if registered.









### To check the handset status

1. Press **Menu** (left softkey  or the selection key  ) to bring up operation menu.
2. Use arrow keys to reach **Settings**  .
3. Browse sub-menus until reaching **Status** sub-menu and press **Select**.

### Basic Network Settings

Once connected to the network the base station attempts to contact a DHCP server to obtain valid network settings (e.g., IP address, subnet mask, gateway address and DNS address) by default.

The users could also configure basic network settings manually. In order to configure the network settings manually, please follow the steps below:

1. Press **Menu** (left softkey  or the selection key  ) to bring up operation menu.
2. Use arrow keys to reach **Settings**  .
3. Navigate to select **Network Settings**.
4. Enter the system PIN code (default: 0000) and press the softkey “Save” (left softkey  ).
5. To change to static IP, press  or  to select **Static** from the **IP Settings** field.
6. Enter valid values in the **IP Address**, **Subnet Mask**, **Gateway**, **DNS Server** fields.
7. Press softkey “Save” (  ) to save and apply the new changes.

A message prompt message will be displayed to confirm that the new settings are saved successfully.



Figure 14: Network Settings configuration



## Register a SIP Account

DP750 supports up to 10 SIP accounts, 5 handsets. Each handset can be configured up to 10 accounts. Please be aware that line settings will be affected by DID settings (hunting group settings) in “DECT - SIP Account Settings”.

### Register account via web user interface

1. Access your DP750 base station web UI by entering its IP address in your favorite browser.
2. Enter your admin’s username and password (default username and password: admin/admin).
3. Press **Login** to access your settings.
4. Go to **Profiles** tab and select a profile to use.

DP750 supports up to 4 profiles. A profile is a set of settings including general settings, network settings, SIP setting, audio setting, call settings and ring tones, and etc. A profile can be used with different SIP accounts.

5. In **General Settings**, set the following:
  - a. **Profile Active** to **Yes**.
  - b. **SIP Server** field with your SIP server IP address or FQDN.
  - c. **Failover SIP Server** with your failover SIP server IP address or FQDN. Leave empty if not available.
  - d. **Prefer Primary SIP Server** to **No** or **Yes** depending on your configuration. Set to **No** if no failover SIP server is defined. If “**Yes**”, account will register to primary SIP server when failover registration expires.
  - e. **Outbound Proxy** with your outbound proxy IP address or FQDN. Leave empty if not available.
6. Press **Save and Apply** to save your configuration.
7. Go to **DECT >SIP Account Settings**



Figure 15: SIP Settings



8. Configure your SIP details in desired account:
  - a. **Account:** Select Account row to configure (Account 1 – Account 10).
  - b. **SIP User ID:** User account information, provided by VoIP service provider (ITSP). Usually in the form of digit similar to phone number or actually a phone number.
  - c. **Authenticate ID:** SIP service subscriber’s authenticate ID used for authentication. Can be identical to or different from SIP User ID.
  - d. **Password:** SIP service subscriber’s account password to register to SIP server of ITSP. For security reasons, the password will field will be shown as empty.
  - e. **Name:** Any name to identify this specific user.
  - f. **Profile:** Select the corresponding Profile ID (1/2/3/4).
  - g. **HS Mode:** Assign the account to specific handset (HS1, HS2...) or hunting group mode.
  - h. **Active:** Set to **Yes**. If set to **No**, account is disabled and will not register.
9. Press **Save and Apply** to save your configuration.

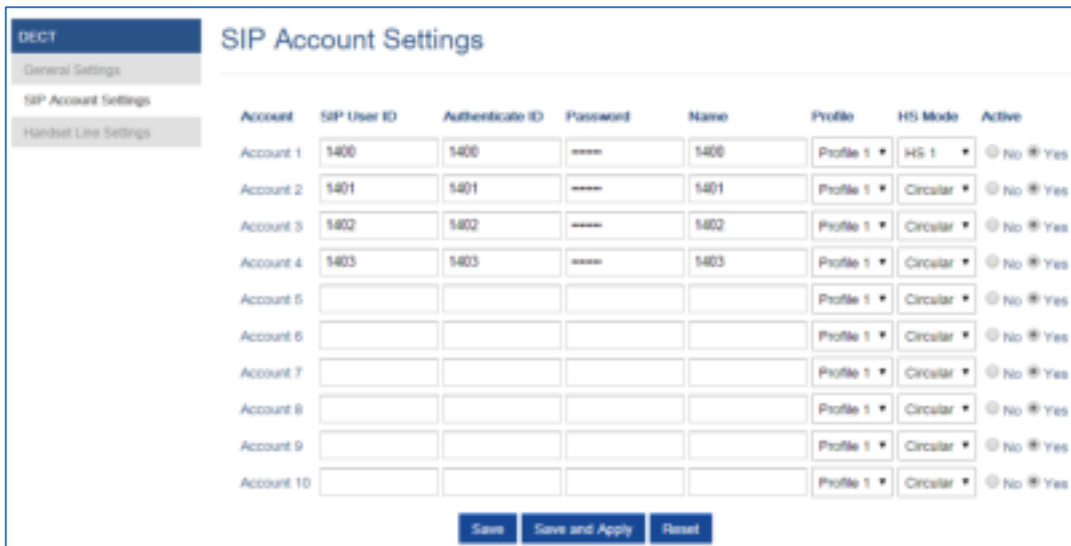

Account	SIP User ID	Authenticate ID	Password	Name	Profile	HS Mode	Active
Account 1	1400	1400	****	1400	Profile 1	HS 1	<input type="radio"/> No <input checked="" type="radio"/> Yes
Account 2	1401	1401	****	1401	Profile 1	Circular	<input type="radio"/> No <input checked="" type="radio"/> Yes
Account 3	1402	1402	****	1402	Profile 1	Circular	<input type="radio"/> No <input checked="" type="radio"/> Yes
Account 4	1403	1403	****	1403	Profile 1	Circular	<input type="radio"/> No <input checked="" type="radio"/> Yes
Account 5					Profile 1	Circular	<input type="radio"/> No <input checked="" type="radio"/> Yes
Account 6					Profile 1	Circular	<input type="radio"/> No <input checked="" type="radio"/> Yes
Account 7					Profile 1	Circular	<input type="radio"/> No <input checked="" type="radio"/> Yes
Account 8					Profile 1	Circular	<input type="radio"/> No <input checked="" type="radio"/> Yes
Account 9					Profile 1	Circular	<input type="radio"/> No <input checked="" type="radio"/> Yes
Account 10					Profile 1	Circular	<input type="radio"/> No <input checked="" type="radio"/> Yes

**Figure 16: Sip Accounts Settings**

After applying your configuration, your phone will register to your SIP Server.

You can verify if your DECT phone has registered with your SIP server from your DP750 web interface under Status > Account Status (a green background with Yes under SIP Registration column for corresponding account indicates the account has been successfully registered).



Status		Account Status									
Account Status		Account	SIP User ID	SIP Server	SIP Registration	HS Mode	HS1	HS2	HS3	HS4	HS5
DECT Status		Account 1	1400	192.168.6.30	YES	HS 1	YES	YES	YES	YES	
Line Options		Account 2	1401	192.168.6.30	YES	Circular					
Network Status		Account 3	1402	192.168.6.30	YES	Circular					
System Info		Account 4	1403	192.168.6.30	YES	Circular					
		Account 5			N/A						
		Account 6			N/A						
		Account 7			N/A						
		Account 8			N/A						
		Account 9			N/A						
		Account 10			N/A						

Figure 17: Account Status





## Return to Idle Screen

Press the **Power Key**  to quickly exit the menu and return back to the main idle screen.

If you do not press any key in a period of time, the LCD screen will automatically exit the menu and return to the idle screen as well.

When you are navigating on the handset's menu, and you receive an incoming call, the LCD screen will automatically exit the menu and you can either accept or reject the call, when the call is terminated, the LCD screen will return back to the idle screen.

## Change Menu and Backlight Timeout

1. Press **Menu** (left softkey  or the selection key  ) to bring up operation menu.
2. Use arrow keys to reach **Settings**  .
3. Navigate to **Display**, and then press "Select" (left softkey  ).
4. Set desired time in seconds for Backlight timeout and for Menu timeout. Available value: 15 seconds, 30 seconds, 60 seconds or disabled. (default is 30 seconds)



## PHONE SETTINGS

This chapter will help you with the instruction for configuring and changing the settings of your DP720,

### Editing the Handset's name

The procedure for changing the name of your handset shown in the display in standby mode is as follows:











1. Press **Menu** (left softkey  or the selection key  ) to bring up operation menu.
2. Use arrow keys to reach **Settings**  .
3. Navigate to select **Handset Name**, and then press “Select” (left softkey  ).
4. Enter the desired name and press “Rename” (left softkey  ) and then the DP720 will display a confirmation message that the rename operation was successful.



Figure 18: Handset Name editing

### Changing the Base PIN Code

Users can change their code PIN by following the steps bellow:

1. Press **Menu** (left softkey  or the selection key  ) to bring up operation menu.
2. Use arrow keys to reach **Settings**  .
3. Navigate to select **System Settings**, and then press “Select” (left softkey  ).
4. Enter the current code PIN (By Default is 0000), a new window will be displayed inviting you to enter the new password, when done press “Save” (left softkey  ) and a prompt message will be displayed to confirm that the new code PIN has been saved successfully.



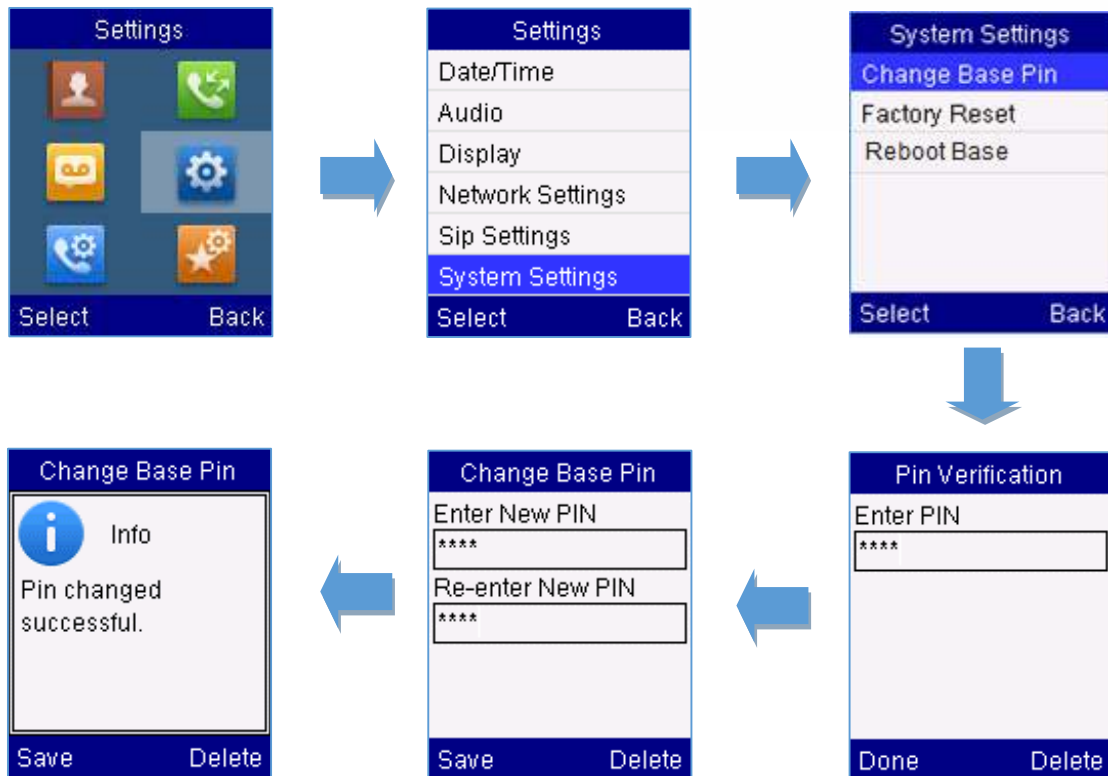

Figure 19: Changing Admin Base PIN Code

## Selecting the Menu Language

The DP720 supports displaying texts in different languages. The handset supports 27 languages (see the table of the technical specifications). The default language of the handset is English. You can change the language according to your requirement. To change the language of the handset, please proceed as follows:





1. Press **Menu** (left softkey  or the selection key  ) to bring up operation menu.
2. Use arrow keys to reach **Settings**  .
3. Navigate to select **Phone language**, then select the desired language and press “Select” (Left softkey  ). The LCD screen prompts “Change phone language to xxx (xxx is the language you selected)”
4. Press “Yes” (left softkey  ) to accept the change. Text displayed on the handset will change to the selected language.











Figure 20: Handset Language

## Activate/Deactivate Hands-Free Mode



This function allows you to make a call without having to hold the handset in your hand.

1. Press the **Hands free key**  while you are making a call or on the idle screen to activate hands free mode.
2. Press the **Hands free key**  again to deactivate the hands free function.

## Muting the Microphone

Press the **Mute key**  to switch off the microphone during an established call. You can now talk freely without the other party hearing you and the icon of mute  will be displayed on the screen. Press the **Mute key**  again to switch the microphone back on.

## Adjusting Speaker and Earpiece Volume

Press left key  or right key  while you are on an established call to set the volume of the earphone / speaker. You can choose between 5 different levels. The default level is 3:

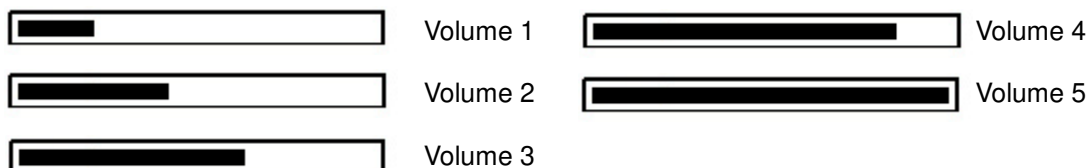





## Ringtones

### Setting the Ringer Volume on the Handset

You can adjust the ringer volume for an incoming call to one of 6 levels (level 1 to 5 and off). Level 5 is the highest level. (The DP720 Handset is set to level 3 by default).

In order to configure the desired ringer volume, proceed as follows:

1. Press **Menu** (left softkey  or the selection key  ) to bring up operation menu.
2. Use arrow keys to reach **Settings**  .
3. Navigate to select **Audio** -> **Volume**
4. Press the left and right arrow keys to change repeatedly and set the desired volume
5. Press "Save" (left softkey  ) to confirm the volume, and a message prompt will be displayed to confirm that the new volume has been successfully saved.

If you select **OFF**, the icon  appears in the display and the handset will not ring for incoming calls.

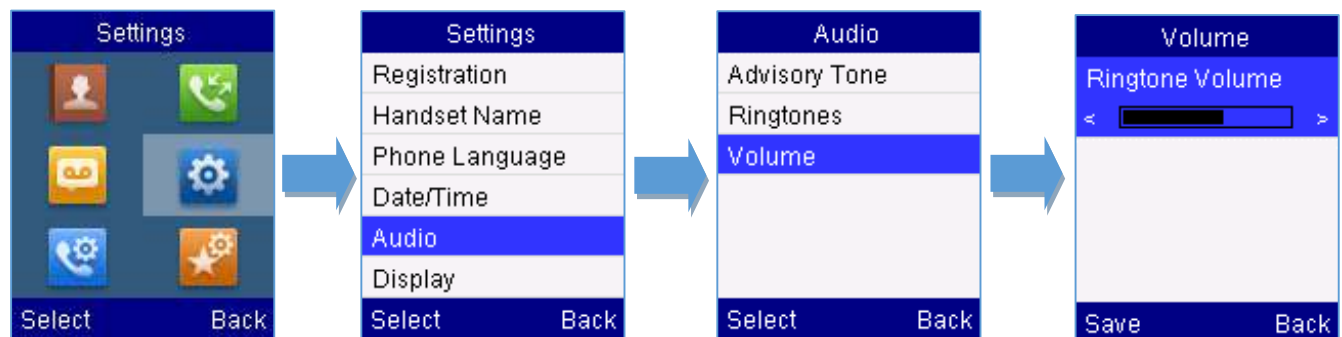





Figure 21: Ringer Volume

### Setting the Ringer Melody on the Handset

You can change the ringer melody for an incoming call. The device has 8 different ringer melodies for you to choose from (1-8).

- The default setting for the ring tone for a call is melody 1.

In order to configure the desired melody, proceed as follows:

1. Press **Menu** (left softkey  or the selection key  ) to bring up operation menu.
2. Use arrow keys to reach **Settings**  .
3. Navigate to select **Audio** -> **Ringtones**.



4. Press “Select” (left softkey  ) to confirm the ringtones selected and a message prompt will be displayed to confirm that the new ringtones has been set successfully.

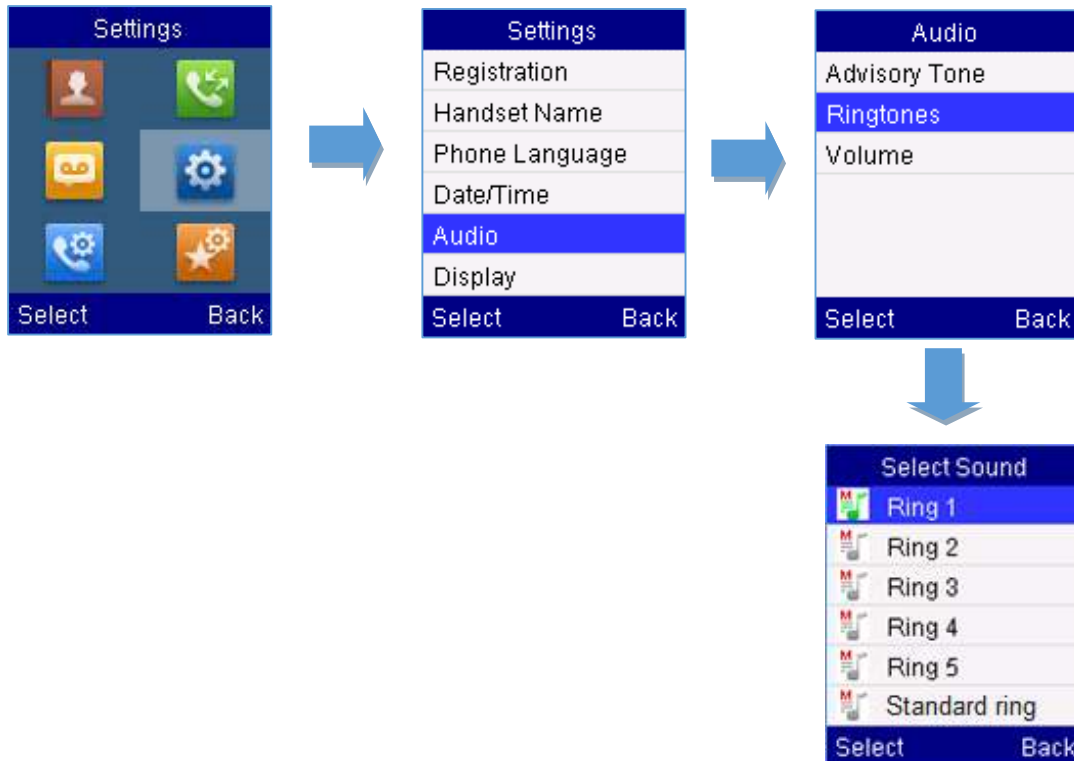





Figure 22: Calls Ringtones

## Advisory Tones

Advisory tones are acoustic signals, which inform you of different actions and states on your handset. The following advisory tones can be configured independently of each other:

- **Keypad tone:** it’s played when a user presses any key of the keypad.
- **Confirmation:** it’s played when a user saves settings or places the handset in the charger cradle.
- **Low battery:** it’s played if the capacity of the batteries is low or the handset requires charging.

### To configure the advisory tones

1. Press **Menu** (left softkey  or the selection key  ) to bring up operation menu.
2. Use arrow keys to reach **Settings**  .
3. Navigate to select **Audio** -> **Advisory tones**, and choose which tone you want to change it.
4. Press the left and right arrow keys to either enable or disable the desired tones.



- Press “Save” (left softkey  ) to confirm, and a message prompt will be displayed to confirm that the new settings has been successfully saved.

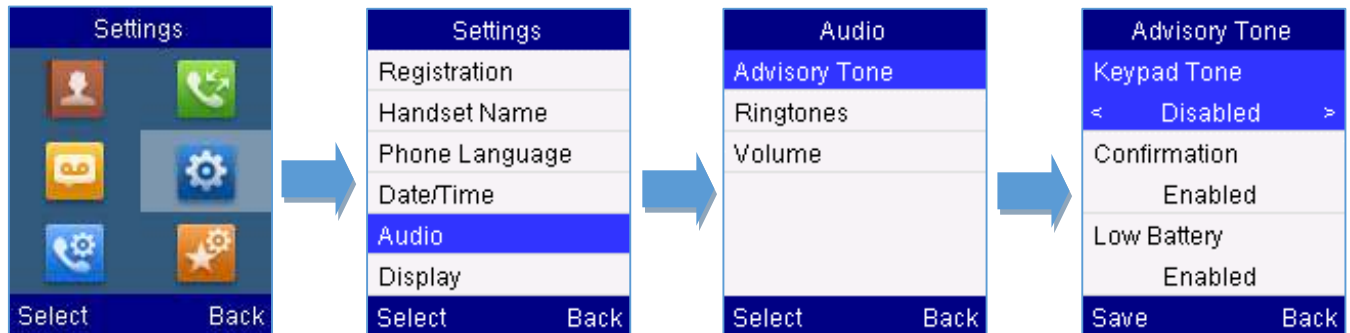

Figure 23: Advisory Tone

## Date and Time

On the DP720 the Date and time are displayed on the idle screen and it obtains the date and time from the Simple Network Time Protocol (SNTP) server by default. If your handset cannot obtain the date and time from the SNTP server, you need to configure the date and time manually. You can configure the time format and date format respectively. The handset supports two time formats (12 Hour or 24 Hour) and three date formats (DD/MM/YYYY; MM/DD/YYYY; YYYY/MM/DD).

### To configure date and time manually







- Press **Menu** (left softkey  or the selection key  ) to bring up operation menu.
- Use arrow keys to reach **Settings**  .
- Navigate to **Date and time**. Edit the current values in the Date & Time fields (you can change the date / time format using the left key  or right key  and press “Set” (left softkey  ).
- Press “Save” softkey to apply your changes.







Figure 24: Date and Time Settings



## Outgoing Default Line

When a handset is configured with more than one line, users can change the default outgoing line on DP720 handset using the keypad menu by following the steps below:



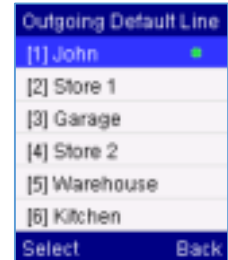

1. Press **Menu** (left softkey  or the selection key  ) to bring up operation menu and access **Call settings**  > **Outgoing Default Line** .
2. The LCD screen displays all outgoing lines currently assigned to the handset. Default outgoing line is highlighted with green button , select the desired line and press “Select” softkey.



## Factory Functions

The factory functions include the following diagnostic options:

- **LCD diagnostic**
- **LCD on / off**
- **Audio loopback**
- **Diagnostic mode**

1. Press **Menu** (left softkey  or the selection key  ) to bring up operation menu.
2. Use arrow keys to reach **Settings**  .
3. Navigate to select **Factory Functions** and choose which diagnostic, you need to perform, and then press “Select” (left softkey  ).

- **Diagnostic mode**

All LEDs will light up. All keys' name will display in red on LCD screen before diagnosing. Press any key on the keypad to diagnose the key's function. When done, the key's name will display in blue on LCD with a prompt message (**PASS**). To exit press “Back” (right softkey  ).

- **Audio loopback**

Speak to the phone using speaker/handset/headset. If you can hear your voice, your audio is working fine. Press “Back” (left softkey  ) to exit audio loopback mode.

- **LCD ON / OFF**

Selects this option to turn off LCD. Press any button to turn on LCD.

- **LCD Diagnostic**

Enters this option and press Left/Right arrow key to do LCD Diagnostic (you will notice that the color of the LCD will be changing). Press right softkey  to quite.



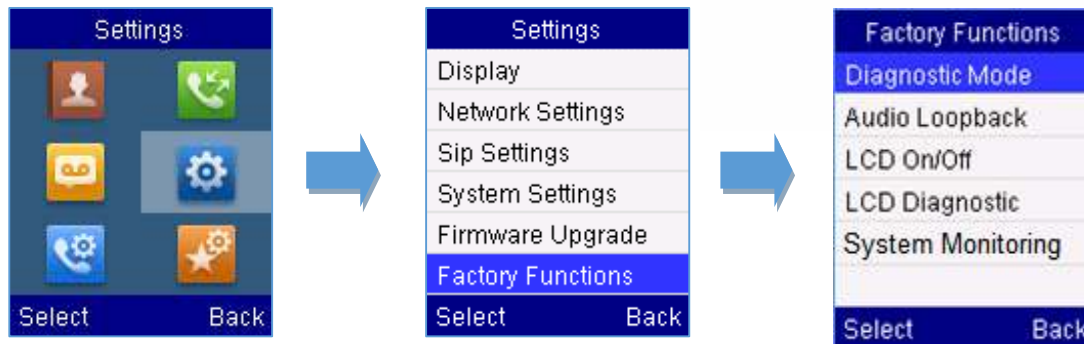

Figure 25: Factory Functions

## Firmware Upgrade

The DP720 handset is able to detect if a new firmware is available when it is registered to a base station.

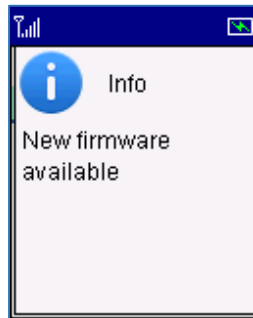





Figure 26: New Firmware Available Notification

To upgrade the firmware on your handset, follow the steps below:

1. Press **Menu** (left softkey  or the selection key  ) to bring up operation menu.
2. Use arrow keys to reach **Settings**  .
3. Navigate to select **Firmware Upgrade** and press the softkey “Select”.
4. The LCD screen will display a prompt message to confirm the firmware downloading / upgrading press the right softkey “Back” to dismiss the upgrade process.

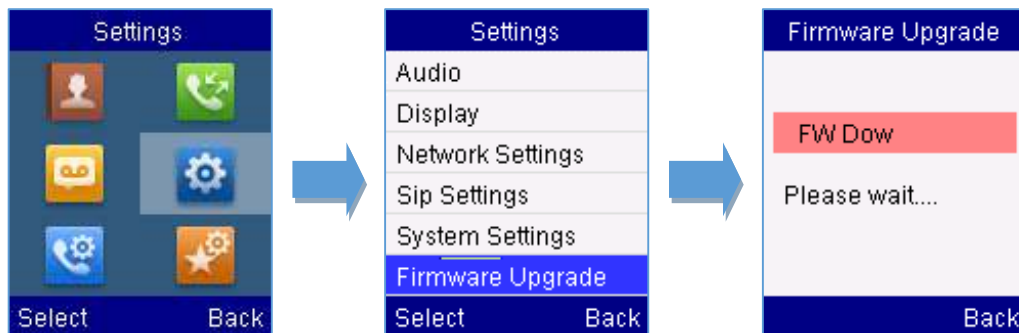

Figure 27: Firmware Upgrade



## Reboot DP750 Base Station





1. Press **Menu** (left softkey  or the selection key  ) to bring up operation menu.
2. Use arrow keys to reach **Settings**  .
3. Navigate to select **Settings** -> **System Settings** and choose **Reboot Base**.
4. Enter Base PIN code (by default the PIN code is: 0000 ).
5. The LCD screen will displays a prompt message to confirm rebooting the base station, press “Yes” (left softkey ) to confirm or press “No” (right softkey ) to cancel.



Figure 28: Rebooting the Base Station

## Reset DP720 Handset

The users can reset the new settings made on the handset after performing factory reset. To reset your handset to the default settings:





1. Press **Menu** (left softkey  or the selection key  ) to bring up operation menu.
2. Use arrow keys to reach **Settings**  .
3. Navigate to select **Settings** -> **System Settings** and choose **Factory Reset**.
4. The LCD screen will displays a prompt message to confirm restoring factory settings, press “Yes” (left softkey ) to confirm and then the handset will reboot to apply the default settings or press “No” (right softkey ) to cancel.



Figure 29: Resetting the Base Station



## CALL OPERATIONS

This chapter will guide you to place calls, transferring and holding the incoming calls.

### Placing calls

To place calls, you can use the following mode:

- **Earpiece mode:** pressing the off-hook key to dial out.
- **Speakerphone mode:** pressing the speakerphone key to dial out.
- **Headset mode:** pressing the off-hook key to dial out using connected headset.



During the call, you can switch the call mode by pressing the corresponding keys or connecting a headset.

### Make a Call using a Line



Making calls require the use of SIP lines. So you should first register the SIP account to the handset beforehand, after registering the sip lines, you can assign one or more outgoing lines for the handset. The handset can only use the assigned outgoing line(s) to place calls.

**Please refer to the following methods in order to make calls using a line:**



#### Method 1:

- **Via default outgoing line:**
  1. Enter the desired number using the keypad.
  2. Press **Dial key**  or **Speaker key**  . The handset will use the default outgoing line to dial out.
  3. To terminate the call, press **Hang-Up key**  .

**Note :** To change the default outgoing line, please refer to [Outgoing Default line](#).



- **Selecting the outgoing line:**
  1. Enter the desired number using the keypad.
  2. Press the left softkey  “Call” .
  3. Select the desired line to dial out.
  4. To terminate the call, press **Hang-Up key**  .

#### Method 2:

1. Press **Dial key**  or **Speaker key**  to enter the pre-dialing screen.
2. Enter the number to dial using the keypad.





3. Press **Dial key**  , # (Use # as dial key” must be configured in web configuration) or wait for 4 seconds and the call will be initiated automatically.
4. To terminate the call, press **Hang-Up key**  .





During the call, you can switch the call mode by pressing the corresponding keys and cancel the dialing operation by pressing the on-hook key. During the call conversations, you can press the left and right navigation keys to adjust the volume. The call duration is displayed on the LCD screen while the call is in progress and call summary will be displayed once the call is terminated.

**Notes:** - To dial “+” please keep pressing “0” key for about 2 seconds.

- To dial from contacts list, choose a contact using navigation keys and press **Dial key** .

## Dialing from Call history

Users may use their call history entries to initiate calls.



1. Press **Menu** (left softkey  or the selection key  ) to bring up operation menu.
2. Use arrow keys to reach **Call History** icon  and then press “Select” (left softkey  ).
3. Select the desired entry, then press **Dial key**  to establish the call.

**Note:** In step 3, users can press “Options” softkey followed by “Edit Dial” option to initiate the call.

The call history list stores the last dialed phone numbers. When the memory of the redial number list is full, the handset will automatically erase the oldest dialed number when a new number is dialed

## Dialing from Phonebook

Users may use their private or shared contacts to initiate calls.





1. Press **Contacts** (right softkey  ) to access phonebook menu.
2. Select **Private** or **Shared** phonebook.
3. Select the contact to call.
4. Press **Dial Key**  to initiate the call.

**Note:** In step 3, users can press “Options” softkey followed by “Edit Dial” option to initiate the call.





## Answering Calls

When receiving an incoming call, you can answer the call using following steps:

- **Earpiece mode:**  
Press **Dial Key**  to pick up the call, or “Accept” softkey (left softkey  ).
- **Speakerphone mode:**  
Press **Speaker Key**  to pick up the call.
- **Headset mode:**  
Press **Dial Key**  to pick up the call, or “Accept” softkey (left softkey  ) using a connected headset.

### Note:

- To answer an incoming call during an established call, press **Dial Key**  , or the **Speaker Key**  , or the “Answer” softkey. The incoming call is answered, and the original call is placed on hold.
- You can switch off the ringer temporarily by pressing **Silent** softkey.

## Ending Calls

To terminate the calls, press **Hang-Up key** .

## Rejecting Calls



To reject an incoming calls, press **Hang-Up key**  or “Reject” softkey (right softkey  )

## Auto Answer

To simply answer the incoming calls by picking up the handset from the charger cradle without having to press the off-hook key.

The auto answer feature works only if the handset is placed in the charger cradle.

### To activate / deactivate the auto answer feature

1. Press **Menu** (left softkey  or the selection key  ) to bring up operation menu.
2. Use arrow keys to reach **Call settings**  , and navigate to **Auto Answer** using the Up / down keys arrow.
3. Press the left softkey “Save” after **Enabling / Disabling** the auto answer option.



## Direct IP Call

Direct IP calling allows two parties, that is, a handset and another VoIP device, to talk to each other in an ad hoc fashion without a SIP proxy.

### Elements necessary to complete a Direct IP Call:

- Both DP720 and other VoIP Device, have public IP addresses, or
- Both DP720 and other VoIP Device are on the same LAN using private IP addresses, or
- Both DP720 and other VoIP Device can be connected through a router using public or private IP addresses (with necessary port forwarding or DMZ).

Users can perform IP calls using Star code following the below steps:

1. Pick up the handset and press **Dial key**  .
2. Dial **\*47** followed by the target IP Address.

**Note:** You can enter directly \*47 + target IP address, and then press the dial key to initiate the call.



### Examples of direct IP calls



- a) If the target IP address is 192.168.0.160, the dialing convention is **\*47 then 192\*168\*0\*160**, followed by pressing the “#” key if it is configured as a send key or wait 4 seconds. In this case, the default destination port 5060 is used if no port is specified.
- b) If the target IP address/port is 192.168.1.20:5062, then the dialing convention would be:  
**\*47 or Voice Prompt with option 47, then 192\*168\*0\*160\*5062** followed by pressing the “#” key if it is configured as a send key or wait for 4 seconds.

**Note:** To use direct IP call, **Use Random Port** setting should be set to **NO**.

## Call Hold/Resume

During an established call, you can put the call on hold and resume following below steps:

1. Press the left softkey  to access the call **Options** and then navigate to **Hold**.
2. Press “Select”, left softkey  to put the call on hold.
3. To resume the call, access the options menu again and navigate to **Resume**, then press **Select**.







If you press  during the call, the first call will be on hold, and you can establish a new call; to resume the initial call, press  .

## Call Waiting

This feature will notify you of a new incoming call during an established call, and display the incoming call information visually on the LCD screen and a call waiting tone will be heard. If this feature is disabled, the new incoming call will be automatically rejected.



### To activate the call waiting feature, follow the next steps:



1. Press **Menu** (left softkey  or the selection key  ) to bring up operation menu.
2. Access to **Call settings**  and then to **Call waiting** sub-menu.
3. Select the account for which you want to enable the Call waiting feature, and then press left softkey “Select”  .
4. Choose between **Enabled** and **Disabled** options and press the softkey “Save”, a prompt message will be displayed to confirm that the call waiting is enabled / disabled.
5. During an established call, press  (dial key) to put first call on hold and answers second incoming call. If no second incoming call, pressing  will give the ability to initiate another call while first one is on hold.

**Note:** You can switch between active/on-hold calls by pressing **Options > Swap**.

## Do Not Disturb

You can activate or deactivate the DND mode for your accounts registered on the handset under the call settings. If DND mode is activated for a specific line, all incoming calls will receive busy treatment depending on your configuration (forward to voice mail, busy tone...)

### To enable or disable the DND mode, follow the next steps

1. Press **Menu** (left softkey  or the selection key  ) to bring up operation menu.
2. Access **Call settings**  and then to **Do Not Disturb** sub-menu.
3. Select the account on which you want to enable / disable the DND mode and then press “Select”
4. Choose between **Enabled** and **Disabled** options and press softkey “Save” to accept the changes, a prompt message will be displayed to confirm that the DND is enabled / disabled.

You can check the line status if the DND mode is enabled on the base station.

## Call forward





The call forward feature will allow you to forward all the incoming calls to the desired number. Three possible call forward types are available on the DP720.

- **Forward all:** All the incoming calls are immediately forwarded.
- **Busy Forward:** Incoming calls are immediately forwarded if the line is busy.



- **No Answer Forward:** Incoming calls are forwarded if not answered after a period of time.

#### To enable the call forward, please refer to the following steps:



1. Press **Menu** (left softkey  or the selection key  ) to bring up operation menu.
2. Access to **Call settings**  and then to **Call Forward** sub-menu.
3. Select the account on which you want to enable/disable the call forward feature and press “Select”.
4. Select the type of call forwarding and enter the number to forward the calls, and then press “Save” (left softkey  ) to apply the settings, a prompt message will be displayed to confirm that the new settings have been saved successfully.

## Call transfer



The DP720 supports the call transfer feature, you can transfer a call to another party using one of the following ways:

- **Blind transfer:** Transfer a call directly to another party without consulting
- **Attended transfer:** Transfer a call with prior consulting.

### Blind Transfer

1. Press the “Options” softkey (Left softkey  ) during a call, and then select **Transfer**.
2. The initial call will be on hold, enter the number or select the handset you want to transfer the call to.
3. Press **Dial key**  . The call is connected to the number or the handset you specified, and the LCD screen prompts **Call Transferred**.

### Attended Transfer

1. Press Left softkey “Options”  during a call, and then select **New call**.
2. Choose the line and enter the number you want to transfer the call to, then press **Dial key**  .
3. Once the second call is established, press left softkey “Option”  and select **Transfer**.



## Speed Dial

Speed dial allows users to perform single-digit dialing to predefined numbers. This feature is particularly useful to speed up dialing the numbers that frequently used or hard to remember. A maximum of 8 speed



dial numbers is allowed. For example, the digit key 2 is configured as a speed dial key and assigned the number 2000, the phone will dial out the number 2000 directly when you long press digit key 2.

#### To assign the frequently used numbers from your shared contacts as speed dial keys:



1. Press **Menu** (left softkey  or the selection key  ) to bring up operation menu.
2. Access to **Call settings**  and then to **Speed Dial** sub-menu.
3. Choose the digit keys (2-9) and press **Assign** to specify the number (from the shared directory) to be as speed dial.

You can press **Change** or **Delete** softkeys to modify/delete a speed dial key

### 3-Way Conference

The DP720 supports creating a local conference with other parties (including handset starting the conference).

#### To start a 3 Way conference, follow below steps:

1. Press the **Dial key**  to place a call to the first party.
2. Press left softkey “Options”  , then select **Conference**
3. Enter the number of the second party you want to add to the conference and press **Dial Key**  .



To drop the conference call, press  or “End” softkey.

**Note:** Conference can be bridged before third party answers.

### Voice Mail

The voice mail feature ensures that you will never miss any important messages. It permits either to leave voice mails to someone else or receive and listen to voice mails via the handset

#### Set Voice mail feature code

1. Press **Menu** (left softkey  or the selection key  ) to bring up operation menu.
2. Access to **Voice Mail**  and then select **Set Voice Mail** sub menu.
3. Select the account and enter the voice mail code feature, then press “Save” softkey.

#### Play voice mail messages

1. Press “Menu” (left softkey  or the selection key  ) to bring up operation menu.



2. Access to **Voice Mail**  and then select **Play Message** sub menu.
3. Select the account to retrieve your voice messages saved on your voice mail.

**Note:** Users can access directly voicemail menu to play messages, by clicking on “View” (left softkey ) when the notification of a new voicemail pops up on the DP720’s LCD screen.

## Call Features

The DP750/DP720 supports traditional and advanced telephony features including caller ID, caller ID with caller Name, call forward and etc.

**Table 10: Call Features**

<b>*30</b>	<b>Block Caller ID</b> (for all subsequent calls) <ul style="list-style-type: none"> <li>• Off hook the phone;</li> <li>• Dial *30.</li> </ul>
<b>*31</b>	<b>Send Caller ID</b> (for all subsequent calls) <ul style="list-style-type: none"> <li>• Off hook the phone;</li> <li>• Dial *31.</li> </ul>
<b>*50</b>	<b>Disable Call Waiting</b> <ul style="list-style-type: none"> <li>• Off hook the phone;</li> <li>• Dial *50.</li> </ul>
<b>*51</b>	<b>Enable Call Waiting</b> <ul style="list-style-type: none"> <li>• Off hook the phone;</li> <li>• Dial *51.</li> </ul>
<b>*67</b>	<b>Call with Caller ID Blocked</b> (per call) <ul style="list-style-type: none"> <li>• Off hook the phone;</li> <li>• Dial *67 and then enter the number to dial out.</li> </ul>
<b>*82</b>	<b>Call with Caller ID Enabled</b> (per call) <ul style="list-style-type: none"> <li>• Off hook the phone;</li> <li>• Dial *82 and then enter the number to dial out.</li> </ul>
<b>*70</b>	<b>Call with Call Waiting Disable</b> (per Call) <ul style="list-style-type: none"> <li>• Off hook the phone;</li> <li>• Dial *70 and then enter the number to dial out.</li> </ul>
<b>*71</b>	<b>Call with Call Waiting Enabled</b> (per Call)



	<ul style="list-style-type: none"> <li>• Off hook the phone;</li> <li>• Dial *71 and then enter the number to dial out.</li> </ul>
*72	<p><b>Unconditional Call Forward.</b> To set up unconditional call forward:</p> <ul style="list-style-type: none"> <li>• Off hook the phone;</li> <li>• Dial *72 and then enter the number to forward the call;</li> <li>• Press OK softkey or SEND key.</li> </ul>
*73	<p><b>Cancel Unconditional Call Forward.</b> To cancel the unconditional call forward:</p> <ul style="list-style-type: none"> <li>• Off hook the phone;</li> <li>• Dial *73;</li> <li>• Hang up the call.</li> </ul>
*90	<p><b>Busy Call Forward.</b> To set up busy call forward:</p> <ul style="list-style-type: none"> <li>• Off hook the phone;</li> <li>• Dial *90 and then enter the number to forward the call;</li> <li>• Press OK softkey or SEND key.</li> </ul>
*91	<p><b>Cancel Busy Call Forward.</b> To cancel the busy call forward:</p> <ul style="list-style-type: none"> <li>• Off hook the phone;</li> <li>• Dial *91;</li> <li>• Hang up the call.</li> </ul>
*92	<p><b>Delayed Call Forward.</b> To set up delayed call forward:</p> <ul style="list-style-type: none"> <li>• Off hook the phone;</li> <li>• Dial *92 and then enter the number to forward the call;</li> <li>• Press OK softkey or SEND key.</li> </ul>
*93	<p><b>Cancel Delayed Call Forward.</b> To cancel the delayed call forward:</p> <ul style="list-style-type: none"> <li>• Off hook the phone;</li> <li>• Dial *93;</li> <li>• Hang up the call.</li> </ul>





## RESTORE FACTORY DEFAULT SETTINGS

---

 **Warning:**

Restoring the factory default settings will delete all configuration information on the phone. Please backup or print all the settings before you restore to the factory default settings. Grandstream is not responsible for restoring lost parameters and cannot connect your device to your VoIP service provider.

---

Please follow the instructions below to reset the phone:

- Press **MENU** button to bring up the keypad configuration menu;
- Select **Settings** and enter;
- Select **System Settings > Factory Reset**;
- A warning window will pop out to make sure a reset is requested and confirmed;
- Press **Yes** softkey to confirm and the phone will reboot.  
To cancel the Reset, press **No** softkey instead.



## EXPERIENCING DP750/DP720

Please visit our website: <http://www.grandstream.com> to receive the most up- to-date updates on firmware releases, additional features, FAQs, documentation and news on new products.

We encourage you to browse our [product related documentation](#), [FAQs](#) and [User and Developer Forum](#) for answers to your general questions. If you have purchased our products through a Grandstream Certified Partner or Reseller, please contact them directly for immediate support.

Our technical support staff is trained and ready to answer all of your questions. Contact a technical support member or [submit a trouble ticket online](#) to receive in-depth support.

Thank you again for purchasing the Grandstream DP720 / DP750, it will be sure to bring convenience and color to both your business and personal life.

