

ONKYO

CR-N765

Network CD Receiver

Instruction Manual

Names and functions of parts	8
Getting started.....	12
Playing CDs	15
Listening to Internet radio.....	18
Playing tracks stored on a USB storage device.....	20
Listening to an iPod/iPhone	22
Listening to AM/FM radio	23
Using a home network	26
Various settings.....	29
Troubleshooting	34

Thank you for purchasing an Onkyo CD receiver.
Please read this manual thoroughly before making any connections and plugging it in.
Following the instructions in this manual will enable you to obtain optimum performance and listening enjoyment from your new CD receiver.
Please retain this manual for future reference.



WARNING:

TO REDUCE THE RISK OF FIRE OR ELECTRIC SHOCK, DO NOT EXPOSE THIS APPARATUS TO RAIN OR MOISTURE.

CAUTION:

TO REDUCE THE RISK OF ELECTRIC SHOCK, DO NOT REMOVE COVER (OR BACK). NO USER-SERVICEABLE PARTS INSIDE. REFER SERVICING TO QUALIFIED SERVICE PERSONNEL.



WARNING

RISK OF ELECTRIC SHOCK
DO NOT OPEN

AVIS

RISQUE DE CHOC ELECTRIQUE
NE PAS OUVRIR



The lightning flash with arrowhead symbol, within an equilateral triangle, is intended to alert the user to the presence of uninsulated "dangerous voltage" within the product's enclosure that may be of sufficient magnitude to constitute a risk of electric shock to persons.



The exclamation point within an equilateral triangle is intended to alert the user to the presence of important operating and maintenance (servicing) instructions in the literature accompanying the appliance.

Important safety instructions

1. Read these instructions.
2. Keep these instructions.
3. Heed all warnings.
4. Follow all instructions.
5. Do not use this apparatus near water.
6. Clean only with dry cloth.
7. Do not block any ventilation openings. Install in accordance with the manufacturer's instructions.
8. Do not install near any heat sources such as radiators, heat registers, stoves, or other apparatus (including amplifiers) that produce heat.
9. Do not defeat the safety purpose of the polarized or grounding-type plug. A polarized plug has two blades with one wider than the other. A grounding type plug has two blades and a third grounding prong. The wide blade or the third prong are provided for your safety. If the provided plug does not fit into your outlet, consult an electrician for replacement of the obsolete outlet.
10. Protect the power cord from being walked on or pinched particularly at plugs, convenience receptacles, and the point where they exit from the apparatus.
11. Only use attachments/accessories specified by the manufacturer.
12. Use only with the cart, stand, tripod, bracket, or table specified by the manufacturer, or sold with the apparatus. When a cart is used, use caution when moving the cart/apparatus combination to avoid injury from tip-over.
13. Unplug this apparatus during lightning storms or when unused for long periods of time.
14. Refer all servicing to qualified service personnel. Servicing is required when the apparatus has been damaged in any way, such as power-supply cord or plug is damaged, liquid has been spilled or objects have fallen into the apparatus, the apparatus has been exposed to rain or moisture, does not operate normally, or has been dropped.

PORTABLE CART WARNING



S3125A

15. Damage Requiring Service

Unplug the apparatus from the wall outlet and refer servicing to qualified service personnel under the following conditions:

- A. When the power-supply cord or plug is damaged,
- B. If liquid has been spilled, or objects have fallen into the apparatus,
- C. If the apparatus has been exposed to rain or water,
- D. If the apparatus does not operate normally by following the operating instructions. Adjust only those controls that are covered by the operating instructions as an improper adjustment of other controls may result in damage and will often require extensive work by a qualified technician to restore the apparatus to its normal operation,
- E. If the apparatus has been dropped or damaged in any way, and
- F. When the apparatus exhibits a distinct change in performance this indicates a need for service.

16. Object and Liquid Entry

Never push objects of any kind into the apparatus through openings as they may touch dangerous voltage points or short-out parts that could result in a fire or electric shock.

The apparatus shall not be exposed to dripping or splashing and no objects filled with liquids, such as vases shall be placed on the apparatus.

Don't put candles or other burning objects on top of this unit.

17. Batteries

Always consider the environmental issues and follow local regulations when disposing of batteries.

18. If you install the apparatus in a built-in installation, such as a bookcase or rack, ensure that there is adequate ventilation.

Leave 20 cm (8") of free space at the top and sides and 10 cm (4") at the rear. The rear edge of the shelf or board above the apparatus shall be set 10 cm (4") away from the rear panel or wall, creating a flue-like gap for warm air to escape.

Precautions

- 1. Recording Copyright**—Unless it's for personal use only, recording copyrighted material is illegal without the permission of the copyright holder.
- 2. AC Fuse**—The AC fuse inside the unit is not user-serviceable. If you cannot turn on the unit, contact your Onkyo dealer.
- 3. Care**—Occasionally you should dust the unit all over with a soft cloth. For stubborn stains, use a soft cloth dampened with a weak solution of mild detergent and water. Dry the unit immediately afterwards with a clean cloth. Don't use abrasive cloths, thinners, alcohol, or other chemical solvents, because they may damage the finish or remove the panel lettering.

4. Power

WARNING

BEFORE PLUGGING IN THE UNIT FOR THE FIRST TIME, READ THE FOLLOWING SECTION CAREFULLY.

AC outlet voltages vary from country to country. Make sure that the voltage in your area meets the voltage requirements printed on the unit's rear panel (e.g., AC 230 V, 50 Hz or AC 120 V, 60 Hz).

The power cord plug is used to disconnect this unit from the AC power source. Make sure that the plug is readily operable (easily accessible) at all times.

For models with [POWER] button, or with both [POWER] and [ON/STANDBY] buttons:
Pressing the [POWER] button to select OFF mode does not fully disconnect from the mains. If you do not intend to use the unit for an extended period, remove the power cord from the AC outlet.

For models with [ON/STANDBY] button only:
Pressing the [ON/STANDBY] button to select Standby mode does not fully disconnect from the mains. If you do not intend to use the unit for an extended period, remove the power cord from the AC outlet.

5. Preventing Hearing Loss

Caution

Excessive sound pressure from earphones and headphones can cause hearing loss.

6. Batteries and Heat Exposure

Warning

Batteries (battery pack or batteries installed) shall not be exposed to excessive heat as sunshine, fire or the like.

- 7. Never Touch this Unit with Wet Hands**—Never handle this unit or its power cord while your hands are wet or damp. If water or any other liquid gets inside this unit, have it checked by your Onkyo dealer.

8. Handling Notes

- If you need to transport this unit, use the original packaging to pack it how it was when you originally bought it.
- Do not leave rubber or plastic items on this unit for a long time, because they may leave marks on the case.
- This unit's top and rear panels may get warm after prolonged use. This is normal.
- If you do not use this unit for a long time, it may not work properly the next time you turn it on, so be sure to use it occasionally.
- When you've finished using this unit, remove all discs and turn off the power.

9. Installing this Unit

- Install this unit in a well-ventilated location.
- Ensure that there's adequate ventilation all around this unit, especially if it's installed in an audio rack. If the ventilation is inadequate, the unit may overheat, leading to malfunction.
- Do not expose this unit to direct sunlight or heat sources, because its internal temperature may rise, shortening the life of the optical pickup.
- Avoid damp and dusty places, and places subject to vibrations from loudspeakers. Never put the unit on top of, or directly above a loudspeaker.
- Install this unit horizontally. Never use it on its side or on a sloping surface, because it may cause a malfunction.
- If you install this unit near a TV, radio, or VCR, the picture and sound quality may be affected. If this occurs, move this unit away from the TV, radio, or VCR.

10. Moisture Condensation

Moisture condensation may damage this unit.

Read the following carefully:

Moisture may condense on the lens of the optical pickup, one of the most important parts inside this unit.

- Moisture condensation can occur in the following situations:
 - The unit is moved from a cold place to a warm place.
 - A heater is turned on, or cold air from an air conditioner is hitting the unit.
 - In the summer, when this unit is moved from an air conditioned room to a hot and humid place.
 - The unit is used in a humid place.
 - Do not use this unit when there's the possibility of moisture condensation occurring. Doing so may damage your discs and certain parts inside this unit.
- If condensation does occur, unplug the power cord and leave the unit for two to three hours in the room temperature.

This unit contains a semiconductor laser system and is classified as a "CLASS 1 LASER PRODUCT". So, to use this model properly, read this Instruction Manual carefully. In case of any trouble, please contact the store where you purchased the unit.

To prevent being exposed to the laser beam, do not try to open the enclosure.

CAUTION:

CLASS 1M VISIBLE AND INVISIBLE LASER RADIATION WHEN OPEN. DO NOT VIEW DIRECTLY WITH OPTICAL INSTRUMENTS. THIS PRODUCT UTILIZES A LASER. USE OF CONTROLS OR ADJUSTMENTS OR PERFORMANCE OF PROCEDURES OTHER THAN THOSE SPECIFIED HEREIN MAY RESULT IN HAZARDOUS RADIATION EXPOSURE.

The label on the right is applied on the rear panel.



1. This unit is a CLASS 1 LASER PRODUCT and employs a laser inside the cabinet.
2. To prevent the laser from being exposed, do not remove the cover. Refer servicing to qualified personnel.

For European Models

Declaration of Conformity

We declare, under our sole responsibility, that this product complies with the standards:

- Safety
- Limits and methods of measurement of radio disturbance characteristics
- Limits for harmonic current emissions
- Limitation of voltage changes, voltage fluctuations and flicker
- RoHS Directive, 2011/65/EU



WEEE

<http://www.onkyo.com/manual/weee/weee.pdf>

DISCLAIMER

Through this device you are able to link to other services or websites which are not under the control of any company which has designed, manufactured or distributed/have distributed this device, and its affiliates (collectively, "Company"). We have no control over the nature, content and availability of those services. The inclusion of any links does not necessarily imply a recommendation or endorse the views expressed within them.

All information, content and services available through this device belong to third parties and are protected by copyright, patent, trademark and/or other intellectual property laws of applicable countries.

The information, content and services provided through this device are for your personal, noncommercial use only. Any information, content or services may not be used in any manner other than previously approved by the appropriate content owner or service provider. You may not modify, copy, republish, translate, exploit, create derivative works, upload, post, transmit, sell or distribute in any manner any information, content or services available through this device, unless expressly permitted by the appropriate copyright, patent, trademark and/or other intellectual property owner, including, without limitation, content owner or service provider.

THE CONTENT AND SERVICES AVAILABLE THROUGH THIS DEVICE ARE PROVIDED "AS IS". COMPANY DOES NOT WARRANT INFORMATION, CONTENT OR SERVICES SO PROVIDED, EITHER EXPRESSLY OR IMPLIEDLY, FOR ANY PURPOSE. COMPANY EXPRESSLY DISCLAIMS ANY WARRANTIES, EXPRESS OR IMPLIED, INCLUDING BUT NOT LIMITED TO, WARRANTIES OF TITLE, NON-INFRINGEMENT, MERCHANTABILITY OR FITNESS FOR A PARTICULAR PURPOSE.

Company makes no representation or warranty of any kind, express or implied, about the completeness, accuracy, validity, legality, reliability, suitability or availability with respect to the information, content or services available through this device. Company shall not be liable, whether in contract or tort, including negligence and strict liability, for any direct, indirect, special, incidental or consequential damages or any other damages arising out of, or in connection with, any information contained in, or as a result of the use of any content or service by you or any third party, even if Company has been advised of the possibility of such damages, nor shall Company be liable for any third party claims against users of this device or any third party. In no event shall Company be responsible nor liable for, without limiting the generality of the foregoing, any interruption or suspension of any information, content or service available through this device. Company is neither responsible nor liable for customer service related to the information, content and services available through this device. Any question or request for service relating to the information, content or services should be made directly to the appropriate content owners and services providers.

Features

Amplifier

- WRAT (Wide Range Amplifier Technology)
- Symmetrical Designed Power Amplifier Circuitry
- 3 Stage Inverted Darlington Amplifier Design
- 2 Digital Inputs (1 Optical/1 Coaxial)
- 3 Audio Inputs and 1 Output
- Optimum Gain Volume Circuitry
- Subwoofer Pre Out
- Headphone amplifier with fully discrete DIDRC (Dynamic Intermodulation Distortion Reduction Circuitry)

CD player

- Plays CDs, MP3/WMA discs, CD-Rs and CD-RWs
- 25 Track Programming
- 2 Repeat Mode (Track/Full)
- 3 Play Modes (Normal/Random/Memory)
- VLSC (Vector Linear Shaping Circuitry)

Network

- DSD native playback (2.8 MHz/5.6 MHz)
- Playback of high-resolution, studio-master-quality sound sources (192 kHz/24 bit) in WAV or FLAC format
- Wide-ranging music formats via Ethernet
MP3, WMA, WMA Lossless, WAV, AAC, FLAC, Ogg Vorbis, LPCM, Apple Lossless

iPod®/iPhone®

- iPod/iPhone Digital Direct Connection via USB (front)

USB interface

- DSD native playback (2.8 MHz/5.6 MHz) (5.6 MHz DSD can only be playback via the front USB port.)
- Playback of high-resolution, studio-master-quality sound sources (192 kHz/24 bit) in WAV or FLAC format
- Gapless playback that enables more natural playback of music (WAV, FLAC, Apple Lossless)
- Wide-ranging music formats
MP3, WMA, WMA Lossless, WAV, AAC, FLAC, Ogg Vorbis, LPCM, Apple Lossless
- 3 Repeat Modes (Track/Full/1 Folder)
- 3 Play Modes (Normal/Random/1 Folder)

Tuner & Other

- 40 AM/FM Presets
- Sleep Timer
- Sleep&Charge Function
- Phase-Matching Bass Boost System
- Music Optimizer™ for Compressed Digital Music files
- Auto Standby Function
- Headphone Jack
- Aluminium Front Panel
- Aluminium Volume Knob
- RI-Dock Compatible Remote Control (iPod/iPhone Control Capable)

Onkyo Remote (smartphone app)

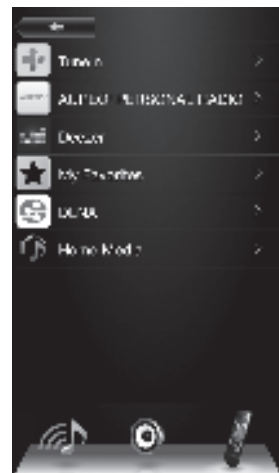

- Input source selection, volume adjustments, and other basic operations possible on your smartphone, which serves as the unit's remote control
- GUI screens that enable intuitive track selection operations on network services, including the Internet radio and DLNA
- Streaming of music data stored on your smartphone
- Available for both the iPod touch/iPhone and smartphones with Android OS

Download (free) the app from Apple's App Store or Google Play. Please note that a wireless LAN environment is required to use the app. In addition, network services may become unavailable when their service providers terminate them.

Contents

Important safety instructions	2	Using a home network	26
Precautions	3	Playing music stored on DLNA-compatible devices	26
Features	5	• Setting up Windows Media Player	26
Supplied accessories	7	• Playing music files by operating the unit	26
Handling the unit	7	• Using the Play To feature	27
Names and functions of parts	8	Music streaming from a shared folder (Home Media)	27
• Front	8	• Setting up Windows	27
• Display	9	• Playing back	28
• Rear	10	Various settings	29
• Remote control	11	• Setting the sound quality	29
Getting started	12	• Inputting characters	29
• 1. Connecting speakers	12	• Sleep timer	29
• 2. AM/FM antenna connections	12	• Menu settings	30
• 3. Network connection	13	• Firmware update	31
• 4. Connecting external devices	13	Troubleshooting	34
• 5. Connecting the power cord	14	Specifications	37
• 6. Turning on the unit	14	Compatible devices/media/file formats	38
Playing CDs	15	Compatible devices/media	38
Basic operations	15	File format	39
Selecting tracks	16		
• Selecting tracks on music CDs (Direct Play)	16		
• Selecting tracks on MP3/WMA discs	16		
Memory playback	17		
Random playback	17		
Repeat playback	17		
Listening to Internet radio	18		
TuneIn	18		
Registering your favorite radio stations (My Favorites)	18		
• Registering a station in the "My Favorites"	19		
• Playing a registered radio station	19		
Playing tracks stored on a USB storage device	20		
Basic operations	20		
Random playback	21		
Repeat playback	21		
Listening to an iPod/iPhone	22		
Listening to AM/FM radio	23		
Tuning into a radio station	23		
• Tuning into stations automatically	23		
• Tuning into stations manually	23		
• Tuning into stations by frequency	23		
Presetting an AM/FM radio station	24		
• Registering radio stations automatically	24		
• Registering radio stations manually	24		
• Selecting preset stations	24		
• Receiving RDS	25		

Supplied accessories

- Remote control (RC-850S) × 1
 - Batteries for remote control (AAA/R03) × 2
 - Power cord × 1
 - AM loop antenna × 1
 - Indoor FM antenna × 1
- * In catalogs and on packaging, the letter at the end of the product name indicates the color. Specifications and operations are the same regardless of color.

Using the remote control

Remove the cover from the back of the remote control and insert two AAA/R03 batteries with their $+/-$ ends oriented in the case as shown. Replace the cover.

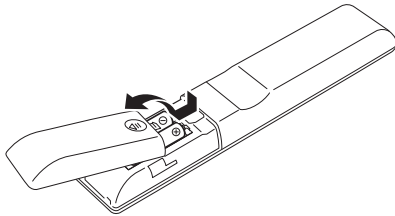

If the operation range of the remote control decreases, the batteries have become exhausted. In this case, replace the batteries with new ones. Dispose of the used batteries according to the instructions on them or requirements set by your local municipality.

- If you intend not to use the remote control for a long time, remove the batteries to prevent damage from leakage or corrosion.
- Expired batteries should be removed as soon as possible to prevent damage from leakage or corrosion.

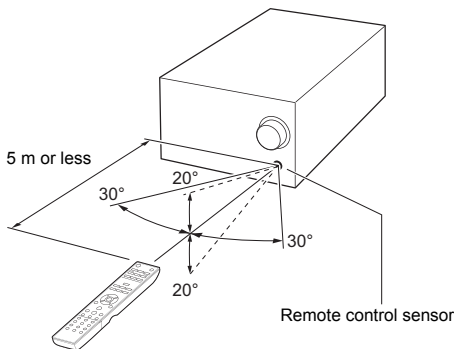

When using the remote control, point it toward the remote control signal receiver on the main unit from a distance of 5 m or less.

- Do not place obstructions between the main unit and the remote control.
- The remote control might not work if the remote control signal receiver on the unit is exposed to direct sunlight or bright light. If this occurs, try moving the unit.
- Beware that use of this remote control could cause the unintentional operation of other devices that can be controlled by infrared rays.

Handling the unit

Precautions for use

Do not install this unit in a location that could become hot. This includes places that are exposed to direct sunlight or near a radiator, heater, stove or other heating equipment. Moreover, do not place it on top of an amplifier or other equipment that generates heat. Doing so could cause discoloration or deformation.

Do not put anything on top of this unit, as it may interfere with proper ventilation.

Do not lift or move the unit during playback because the disc rotates at high speed. Doing so could damage the disc.

Always remove any loaded disc before moving this unit or packing it for installation in a different location, for example. Moving the unit with a disc inside could cause a malfunction.

Names and functions of parts

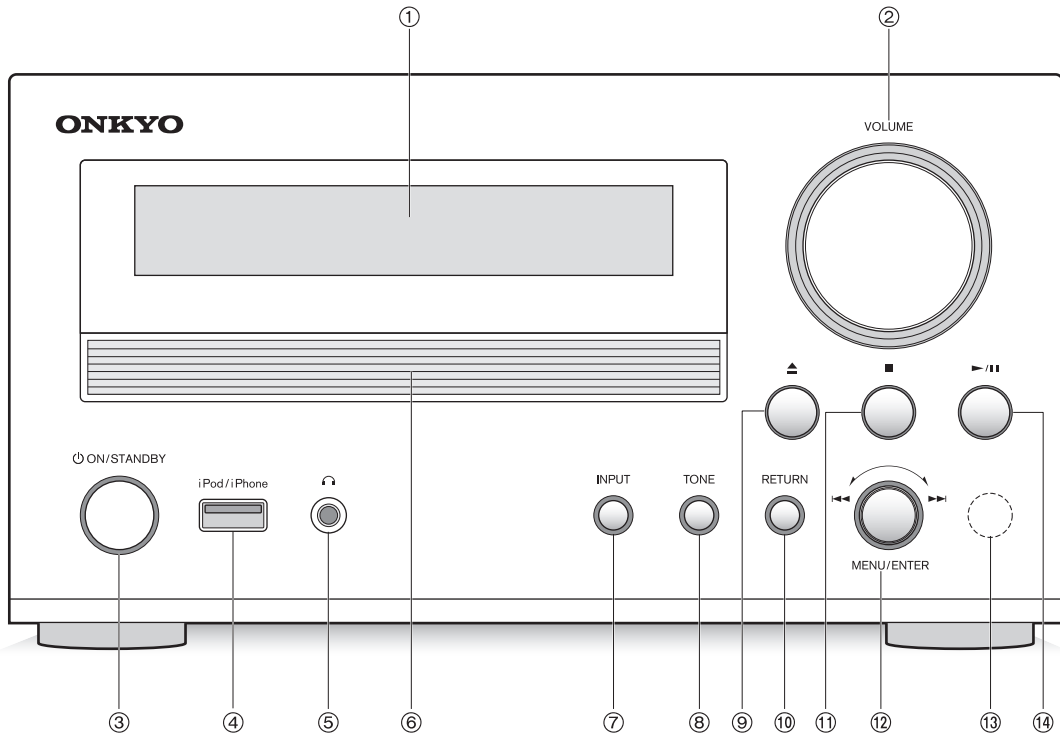

Front

- ① **Display**
- ② **VOLUME control:** Used to adjust the volume.
- ③ **ON/STANDBY button:** Press this button to turn the unit on or put it in standby mode.
- ④ **USB port:** Use to connect an iPod, iPhone or USB storage to the unit.
- ⑤ **Phones jack:** Turn down the volume, then connect your stereo headphones to the Phones mini jack. The speakers output no sound while the headphones are connected.
- ⑥ **Disc tray**
- ⑦ **INPUT button:** Use this button to select the source.
- ⑧ **TONE button:** Used to adjust the tone.
- ⑨ **Tray open/close (▲) button**
- ⑩ **RETURN button:** When a menu is displayed, press to return to the previous menu.
- ⑪ **Stop (■) button**
- ⑫ **MENU/ENTER button, Skip (◀◀/▶▶) dial:** Turn clockwise to skip to later tracks or counterclockwise to skip to earlier tracks. Turn to change the item or setting value shown when a menu is displayed. Press to use as the ENTER button to confirm settings. Press and hold to use as the MENU button.
- ⑬ **Remote control signal receiver**
- ⑭ **Playback/pause (▶/||) button**

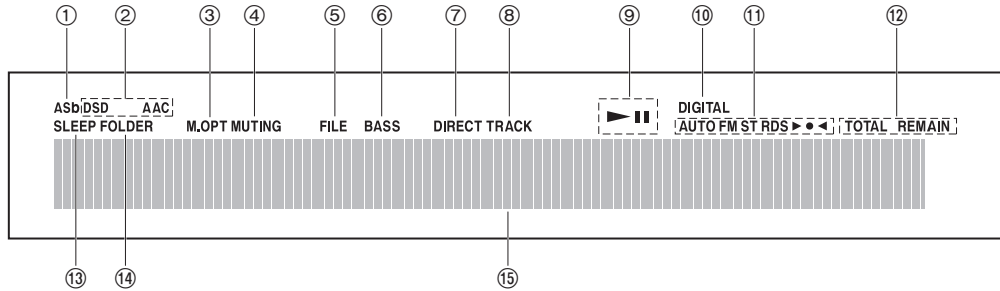

Display

- ① **Auto Standby (ASb) indicator:** This indicator appears when the Auto Standby function is on.
- ② **Format indicators:** When a DSD or AAC audio file is playing, the DSD or AAC indicator appears according to the file format.
- ③ **Music Optimizer (M.OPT) indicator:** This indicator appears when Music Optimizer (M.OPT) is on.
- ④ **MUTING indicator:** This indicator flashes when audio is muted temporarily.
- ⑤ **FILE indicator:** When the source is set to CD and a disc containing audio files is loaded, this indicator appears. The number of files or a file number appears below the indicator.
- ⑥ **BASS indicator:** This indicator appears when Phase Matching Bass (PM.Bass) of the audio quality setup is on.
- ⑦ **DIRECT indicator:** This indicator appears when Direct of the audio quality setup is on.
- ⑧ **TRACK indicator:** When the source is set to CD and a music CD is loaded, this indicator appears. The number of tracks or a track number appears below the indicator.
- ⑨ **Play/pause (▶/||) indicator**
- ⑩ **DIGITAL indicator:** When the source is set to OPTICAL/COAXIAL, the indicator status changes as follows:
On: The unit is receiving digital audio input signals.
Flashing: The unit is not receiving digital audio input signals.
- ⑪ **AM/FM reception statuses**
AUTO: This indicator appears when Auto Tuning Mode is selected.
FM ST: This indicator appears when the unit is tuned into a stereo FM broadcast.
RDS: This indicator appears when the unit receives RDS information.
▶◀◁: This indicator appears when the unit is tuned into a radio station.
- ⑫ **TOTAL/REMAIN indicator:** When the source is set to CD, this indicator shows what information about the disc is being displayed.
TOTAL: Total disc playback time
REMAIN: Remaining playback time of track being played
TOTAL REMAIN: Remaining playback time of disc being played
- ⑬ **SLEEP indicator:** This indicator appears when the sleep timer is set.
- ⑭ **FOLDER indicator:** When the source is set to CD and a disc containing audio files is loaded, this indicator appears. The number of folders or a folder number appears below the indicator.
- ⑮ **Message display area:** Track information and menus appear here.
The following icons appear.
- : Folder*
 - : Track/Broadcast station name
 - : Playing back*
 - : Paused*
 - : Searching forward*
 - : Searching backward*
 - : Artist name
 - : Album name
 - : Repeat mode
 - : Repeat one track
 - : Folder repeat*
 - : Memory**
 - : Random
- * Does not appear when the source is CD.
** This only appears when the source is CD.

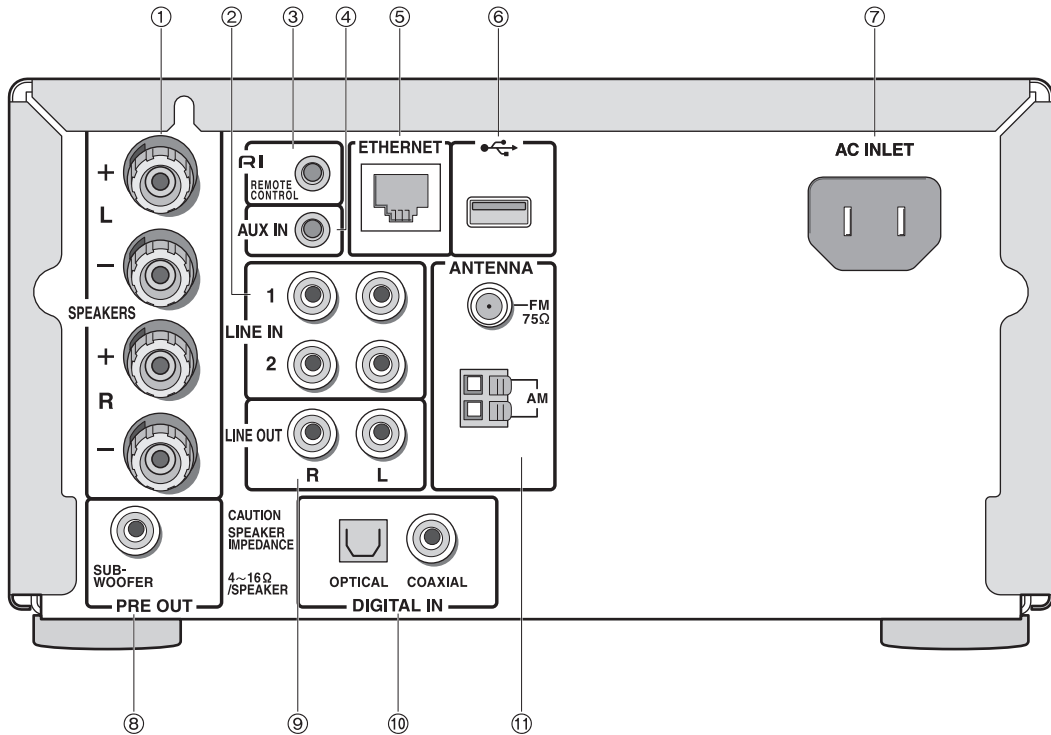

Rear

- ① **SPEAKERS terminals:** Speakers are connected.
- ② **LINE IN terminals:** These analog audio inputs are for connecting Onkyo RI Dock and cassette deck, etc.
- ③ **RI REMOTE CONTROL terminal:** An Onkyo RI Dock with RI jack can be connected.
- ④ **AUX IN terminal:** A stereo mini jack can be connected.
- ⑤ **ETHERNET port:** A LAN cable can be connected.
- ⑥ **USB terminal:** Use to connect a USB storage device to the unit.
- ⑦ **AC INLET terminal:** The supplied power cord is connected.
- ⑧ **SUBWOOFER PRE OUT terminal:** A powered subwoofer can be connected.
- ⑨ **LINE OUT terminals:** This analog audio output is for connecting a recorder such as cassette deck.
- ⑩ **DIGITAL IN OPTICAL/COAXIAL jacks:** Digital audio signals are input.
- ⑪ **FM 75Ω and AM ANTENNA terminals:** The supplied antennas are connected.

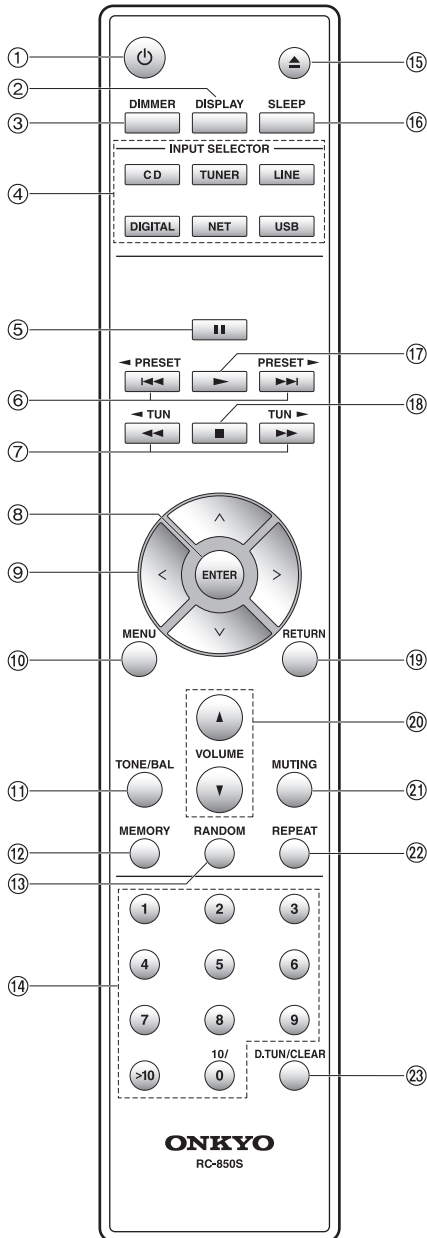

Unless otherwise indicated, the operations described in this manual are based on remote control operation. You can also use the buttons on the unit that provide the same functions as those on the remote control.

Remote control

- ① **⏻ button:** Press this button to turn the unit on or put it in standby mode.
- ② **DISPLAY button:** Change the information shown.
- ③ **DIMMER button:** Use this button to switch the display's brightness between normal, moderately dark and dark.
- ④ **INPUT SELECTOR buttons:** Use these buttons to select the source.
 - CD button:** Use this button to play a CD.
 - TUNER button:** Use this button to listen to the AM/FM radio. Each time you press this button, the radio switches between "AM" and "FM".
 - LINE button:** Use this button to listen to music stored on an external device through an analogue connection. Each time you press this button, the input setting switches among "AUX IN", "LINE1" and "LINE2".
 - DIGITAL button:** Use this button to listen to music stored on an external device through a digital connection. Each time you press this button, the input setting switches between "OPTICAL" and "COAXIAL".
 - NET button:** Use this button to listen to the Internet radio or to use your home network.
 - USB button:** Use this button to listen to music on a USB storage device or iPod/iPhone. Each time you press this button, the input setting switches between "USB(F)" (front panel) and "USB(R)" (rear panel).
- ⑤ **Pause (||) button**
- ⑥ **Skip (◀◀/▶▶)/◀ PRESET/PRESET ▶ buttons**
- ⑦ **Search (◀◀/▶▶)/◀ TUN/TUN ▶ buttons**
- ⑧ **ENTER button:** Use this button to confirm menu selections and setting values.
- ⑨ **Direction (▲/▼/◀/▶) buttons**
- ⑩ **MENU button:** Press this button to display the menu.
- ⑪ **TONE/BAL button:** Use this button to adjust the tone.
- ⑫ **MEMORY button**
- ⑬ **RANDOM button**
- ⑭ **Number buttons**
- ⑮ **Tray open/close (▲) button**
- ⑯ **SLEEP button:** Press this button to set the sleep timer.
- ⑰ **Playback (▶) button**
- ⑱ **Stop (■) button**
- ⑲ **RETURN button:** Press this button to return to the previous display.
- ⑳ **VOLUME (▲/▼) buttons**
- ㉑ **MUTING button:** Temporarily mutes audio.
- ㉒ **REPEAT button**
- ㉓ **D.TUN/CLEAR button:** Use this button to directly input an AM/FM radio frequency or clear the characters that you have input.

Getting started

1. Connecting speakers

Refer to the illustration below to connect the unit and the right and left speakers with the speaker cables. Connect the speaker to be placed on the right hand side to the SPEAKERS terminal (R), and connect the speaker to be placed on the left hand side to the SPEAKERS terminal (L). Since the unit is equipped with the SUBWOOFER PRE OUT terminal, you can enhance bass sound playback by connecting a subwoofer with a built-in power amplifier.

Important: Connect speakers with $4\ \Omega$ to $16\ \Omega$ impedance. Connecting a speaker with a lower impedance may damage the speaker.

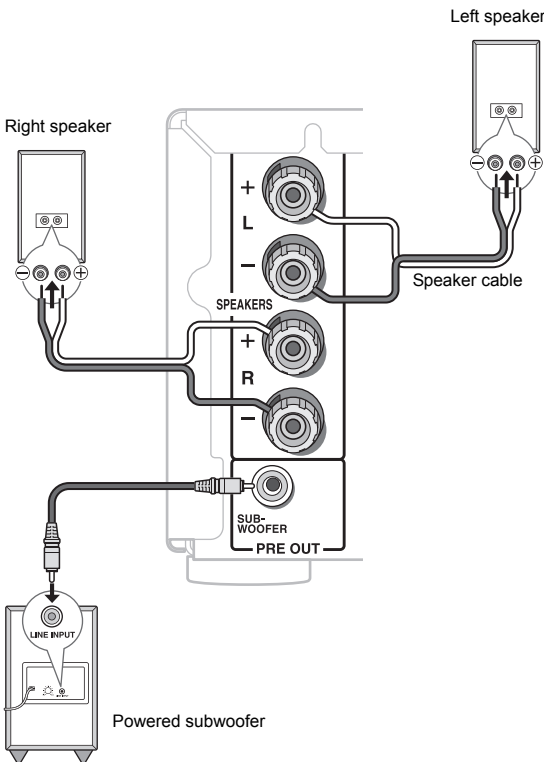

Cut and remove the plastic coating from the end of the speaker cable, twist the core and connect it to the terminal. Make correct connection between the unit's jacks and speaker's jacks (+ to + and - to -) for each channel. If connection is wrong, a bass sound may become poor due to reverse phase.

- Short-circuiting the + cable and - cable or contacting the cable core to the rear panel of the unit may cause

failure. Also do not connect two or more cables to one speaker terminal or one speaker to several terminals.

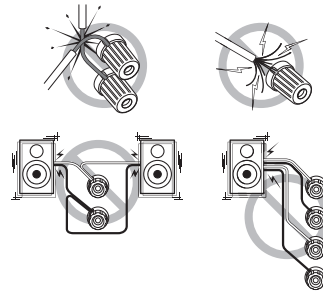

2. AM/FM antenna connections

Connect the antennas to listen to AM/FM broadcast. When listening to the broadcast for the first time, adjust the antenna position and orientation to get the best reception.

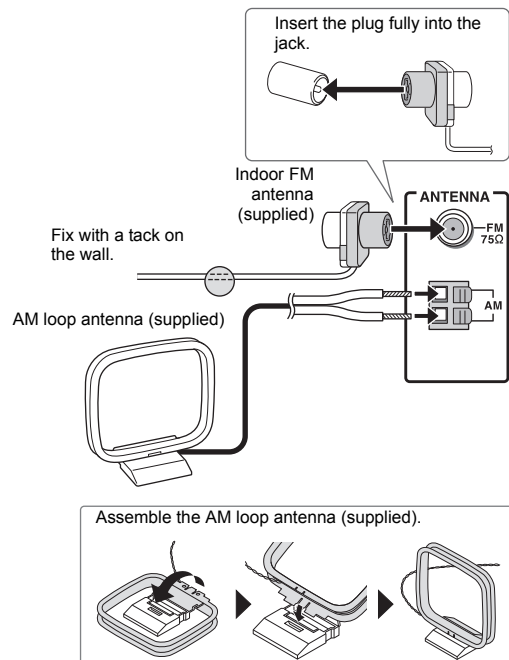

3. Network connection

You can enjoy Internet radio and DLNA by connecting the unit to LAN. Connect the LAN cable to the ETHERNET port.

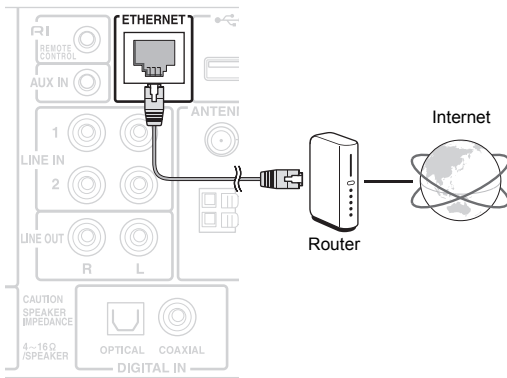

- Use a shielded CAT5 LAN cable (straight-type).
- To connect the unit to another network device or to the Internet, you must configure the relevant settings of each device. For information on the setup, see the instruction manual for each device or contact its manufacturer or your ISP (Internet Service Provider).

4. Connecting external devices

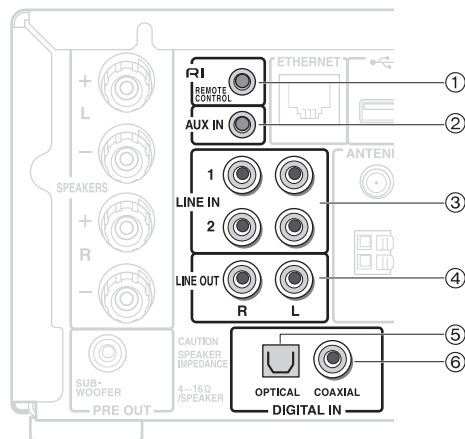

① RI REMOTE CONTROL (connecting an Onkyo RI Dock)

Required: an RI cable

You can control an RI Dock with the remote control of the unit by connecting the cable.

To use the RI function, you must change the input source name to "DOCK". For details, see "Sel Change (Selector Change)" under "Menu settings" under "Various settings".

- When playback is started on the RI Dock, this unit will automatically select it as the input source.

- For details on the connection to an RI Dock and its operations, see the instruction manual of your RI Dock.

② AUX IN (analog audio input)

Required: a stereo mini-plug (ø 3.5 mm)

To listen to music stored on a connected device, press the LINE button repeatedly to switch the input source to "AUX IN".

③ LINE IN (analog audio input)

Required: an audio pin cable

To listen to music stored on a connected device, press the LINE button repeatedly to switch the input source to "LINE1" or "LINE2".

④ LINE OUT (analog audio output)

Required: an audio pin cable

This analog audio output is for connecting a recorder such as cassette deck.

⑤ DIGITAL IN OPTICAL (digital audio input)

Required: an optical digital cable

To listen to music stored on a connected device, press the DIGITAL button repeatedly to switch the input source to "OPTICAL".

- As the digital in optical jack of the unit has a cover, push in the cable against the cover as it is turned inside.
- To prevent cover damage, hold the optical plug straight when inserting and removing.

⑥ DIGITAL IN COAXIAL (digital audio input)

Required: a coaxial digital cable

To listen to music stored on the connected device, press the DIGITAL button repeatedly to switch the input source to "COAXIAL".

- Read the manuals supplied with your other components.
- Don't connect the power cord until you've completed and double-checked all connections.
- Push plugs in all the way to make good connections. Loose connections can cause noise or malfunctions.

5. Connecting the power cord

Do not use a power cord other than the one supplied with this unit. Before connecting the power cord, connect all of your speakers and components.

Always connect the power cord to an AC outlet only after connecting it to the AC INLET terminal of the unit.

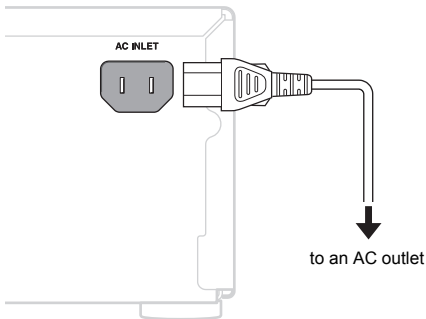

Turning on the unit may cause a momentary power surge that might interfere with other electrical equipment on the same circuit. If this is a problem, plug the unit into a different branch circuit.

Disconnect the power cord only after putting the unit into standby mode. To avoid electrical shock, always disconnect the power cord from the AC outlet before disconnecting the other end.

- This unit consumes power when in standby mode.

6. Turning on the unit

1. Press the  button.

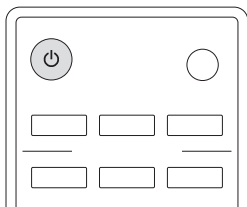

- If you turn on the unit when the input source is set to USB or NET, "Now Initializing..." appears on the display. It will take 20–30 seconds until the unit recognizes the input.

To return the unit to standby mode, press the  button again.

About the Auto Standby function: The Auto Standby function is set to "On" by default. This means when the unit is left without audio input for 2 hours, it will automatically enter standby mode.

Playing CDs

Basic operations

This unit can play the following types of discs and files.

Discs: Music CD (CD-DA), CD-R, CD-RW

File format: MP3/WMA

1. Press the CD button to change the source to "CD".

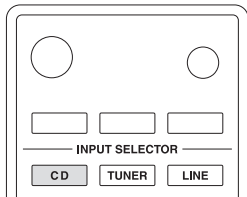

2. Press the tray open/close (▲) button.
3. Place the CD on the tray.
Place the CD on the tray with the label-side facing up.
Place 8 cm CDs in the center of the tray.
4. Press the tray open/close (▲) button to close it.
Information on the CD appears on the display.
 - Depending on the CD, reading data from it may take some time.

Example: Music CD

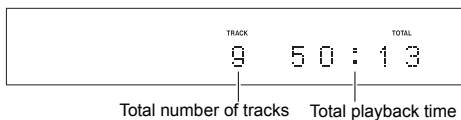

Example: MP3/WMA disc

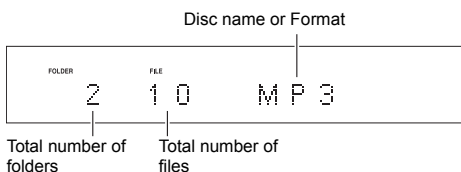

5. Press the playback (▶) button.
Playback starts from the first track.

■ **Stop:** Press the stop (■) button.

■ **Pause:** Press the pause (||) button. Playback resumes when you press the pause (||) button again.

■ **Skip:** Press the skip (◀◀/▶▶) button to skip to tracks before or after the current track. Keep pressing until the desired track is selected.

- During playback, press the ◀◀ button once to return to the beginning of the current track. To return to the beginning of the previous track, keep pressing the ◀◀ button.
- During memory playback, tracks from earlier or later in the memory will be played back.

■ **Search backward/forward:** During playback, press the search (◀◀/▶▶) buttons to search backward/forward. Release the button when you find the desired part. Playback resumes from that point.

■ **Information shown on the display:** Press the DISPLAY button repeatedly during playback to change the information shown on the display.

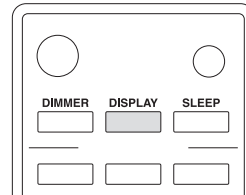

During music CD playback: Elapsed time of current track → REMAIN (remaining time of track being played) → TOTAL REMAIN (remaining time of disc being played)

- If the random playback or total playback time exceeds 99 minutes and 59 seconds, "--:--" is shown.

During MP3/WMA disc playback: Elapsed time of current track → File name → Folder name → Title (if file has ID3 tag) → Artist (if file has ID3 tag) → Album (if file has ID3 tag) → Sampling rate and bit rate

- If the file currently playing back exceeds 99 minutes and 59 seconds, "--:--" is shown.
- Characters in track and folder names that cannot be shown are indicated with asterisks (*). The unit can also be set to show the file or folder number when characters that cannot be shown are included. For details, see "BAD NAME" under "Menu settings" under "Various settings".

Selecting tracks

Selecting tracks on music CDs (Direct Play)

During playback or when stopped, you can use the remote control number buttons to select a track by number.

Example: entering track number 7

Press [7].

Example: entering track number 23

Press [>10], [2] and [3].

Playback starts after the track number is input.

Selecting tracks on MP3/WMA discs

This manual refer to MP3, WMA, and other music data as "file" and a container in which files are stored as "folder". When you select a file on a MP3/WMA disc containing multiple folders, it is convenient to use Navigation mode or All folder mode.

Navigation mode

In this mode, select the file you want to play by navigating through the folder hierarchy from the top to lower levels. For example, in the figure below, folders appear in the order of 1 to 3, and you can proceed to a deeper level when you select a folder.

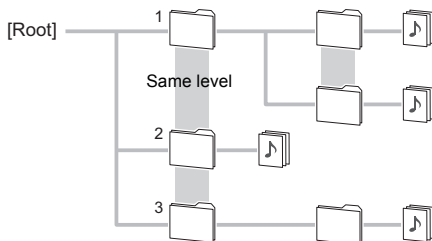

1. When stopped, press the stop (■) button.
"Root" appears on the display and navigation mode is activated.
2. Press the playback (▶) button.
The name of the first folder inside the "Root" directory appears.
If there are no folders, the name of the first file appears.
3. Use the skip (◀◀/▶▶) buttons to select a folder, and press the ENTER button or playback (▶) button to enter that folder.
 - To select a folder in a folder, repeat this step.
4. Use the skip (◀◀/▶▶) buttons to select a file.
 - To move up one level, press the pause (⏸) button.
 - To deactivate this mode, press the stop (■) button.
5. After selecting the desired file, press the ENTER button or playback (▶) button.
Playback starts.

All folder mode

In this mode, only the folders containing music files appear when you select a file. For example, in the figure below, folders appear in the order of 1 to 4.

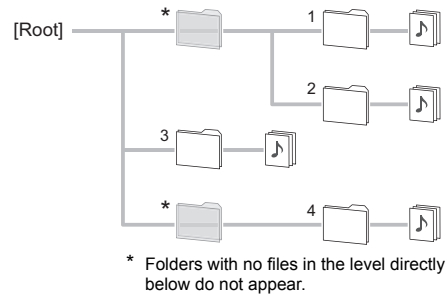

1. When stopped, press the pause (⏸) button.
"1" appears on the display and all folder mode is activated.



2. Use the skip (◀◀/▶▶) buttons to select a folder, and press the ENTER button or playback (▶) button to enter that folder.
3. Use the skip (◀◀/▶▶) buttons to select a file.
 - To return to the folder selection, press the pause (⏸) button.
 - To deactivate this mode, press the stop (■) button.
4. After selecting the desired file, press the ENTER button or playback (▶) button.
Playback starts.

Memory playback

This unit can store up to 25 tracks in the memory.

1. When stopped, press the MEMORY button.

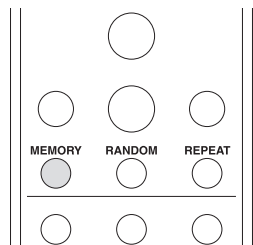

appears on the display.

2. Add tracks to the memory.
 - When using a music CD, use the skip (◀◀/▶▶) buttons to select a track to store, and press the ENTER button or playback (▶) button to add the track to the memory. You can also select tracks using the number buttons.
 - When using an MP3/WMA disc, follow the procedures in “Selecting tracks on MP3/WMA discs”.
 - If you register tracks one after another, they will be registered to the end of the memory.

Example: MP3/WMA disc

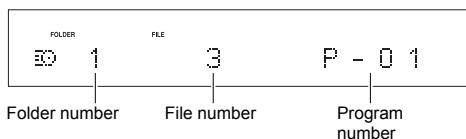

3. Press the playback (▶) button to start playback.

■ **Checking the memory content:** If you press the search (◀◀/▶▶) buttons while a music CD is stopped, a track number and the playback time appear. If you perform the same operation while a MP3/WMA disc is stopped, a folder number, file number and file name appear.

■ **Clearing tracks from the memory:** When stopped, press the CLEAR button to remove the last track that was added to the memory.

■ **Ending memory playback:** When stopped, press the MEMORY button.

- Memory playback will also end if you press the tray open/close (▲) button to open the tray or put the unit into standby.

Random playback

With random playback, all of the tracks on the disc are played in random order.

1. When stopped, press the RANDOM button.

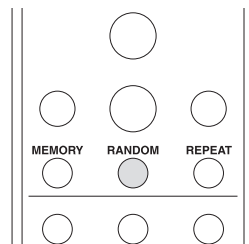

appears on the display.

2. Press the playback (▶) button to start playback.

■ **Ending random playback:** When stopped, press the RANDOM button.

- Random playback will also end if you press the tray open/close (▲) button to open the tray or put the unit into standby.

Repeat playback

1. Press the REPEAT button repeatedly to select the repeat modes.

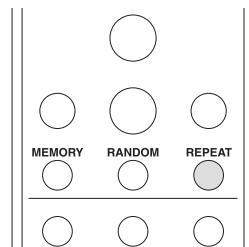

The following icons appear on the display:

: Repeats all tracks.

: Repeats one track.

- Repeat playback and memory playback/random playback can be used together.

■ **Ending repeat playback:** Press the REPEAT button repeatedly until the repeat icon disappears.

- Repeat playback will also end if you press the tray open/close (▲) button to open the tray or put the unit into standby.

Listening to Internet radio

Some Internet radio services are registered to the unit by default. You can display the desired service, menu or radio station on the display and play the radio with simple remote control operation.

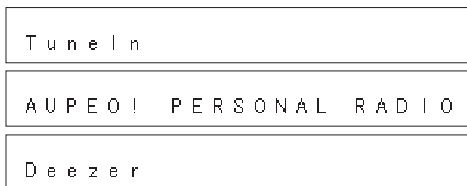

This manual describes operations for TuneIn as an example. You can also enjoy other services by performing operations in the same way. You can also listen to broadcast stations that are not included in the preset services by registering them to "My Favorites", which appears when you press the NET button.

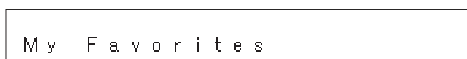

- An Internet connection is necessary to listen to Internet radio programs. If service from the service provider stops, use of that network services and contents might cease to be possible. For details on services, see the website of each service provider.
- Services available may vary depending on the region.

TuneIn

With the radio stations and the on-demand programs registered, TuneIn is a service where you can enjoy music, sports and news from all over the world.

Playing back

1. Press the NET button.

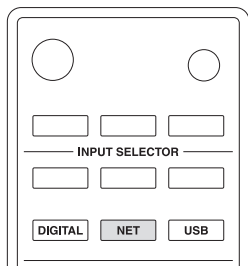

2. Use the direction (^ / v / < / >) buttons to select "TuneIn" on the display and press the ENTER button.

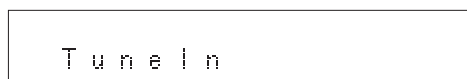

3. Press the direction (^ / v / < / >) buttons to select a folder or menu item from the "TuneIn" top list, and press the ENTER button.
 - The folders and menu items displayed on the top list are provided by the Internet radio service and categorised by genre, etc.
 - To return to the previous display, press the RETURN button.
4. Use the direction (^ / v / < / >) buttons to select a radio station and press the ENTER button. Playback starts.

TuneIn Menu

If you press and hold the MENU button while playing TuneIn, the following TuneIn menu items appear. To use each function, use the direction (^ / v) buttons to select a menu item on the display, and press the ENTER button. Menu items to be displayed differ depending on the broadcast station you are playing.

Add to My Presets: Registers radio stations and programs in your "My Presets" folder within TuneIn. (When an item has been registered, the "My Presets" folder will be added to the "TuneIn" top list.)

Remove from My Presets: Deletes a radio station or program from your "My Presets" folder.

Clear recents: Clears all radio stations and programs from the "Recents" folder within "TuneIn" top list.

Add to My Favorites: Registers radio stations and programs in "My Favorites".

- Other menu items include "View Schedule", which displays the program guide of radio stations and "Report a problem".

Regarding the TuneIn Account

Creating an account on the TuneIn website (tunein.com) and logging in it from the unit allows you to automatically add radio stations and programs to your "My Presets" folder on the unit as you save them on the website.

To log in from the unit: Select "Login" - "I have a TuneIn account" in the "TuneIn" top list on the unit, and then enter your user name and password. If you select "Login" - "Login with a registration code" to display a registration code, access My Info on the TuneIn website, and specify the device identity with the registration code, you will stay logged into the website until you log out from the unit.

- For information on how to input characters, see "Inputting characters" under "Various settings".

Registering your favorite radio stations (My Favorites)

You can listen to your favorite radio stations by registering them to "My Favorites", which appears when you press the NET button. "My Favorites" allows you to register up to 40 stations.

- This unit supports Internet radio stations that use the PLS, M3U and podcast (RSS) formats. Even if an Internet radio station uses one of these formats, playback might not always be possible depending on the type of data and playback format.

Registering a station in the “My Favorites”

There are two ways to register your favorite radio stations to “My Favorites”: you can either use a PC or operate the unit.

Registering a station with PC

You will need the name and URL of the radio station to add during the storing procedure, so check them in advance. You have to connect your PC and this unit to the same network.

Input the IP address of the unit into an Internet browser on the PC to access WEB Setup and register a station.

1. Press the MENU button.

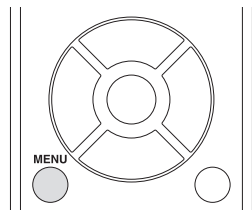

2. Use the direction (^ / v) buttons to select “NET Setting” on the display and press the ENTER button.
3. When “IP Address” appears press the ENTER button. Make a note of the IP address.
4. Turn the PC on and open Internet Explorer or another Internet browser.
5. Input this unit’s IP address into the Internet browser URL field. If the IP address displayed on the unit is “1 9 2 1 6 8 x x y y”, input “192.168.xxx.yyy” into the URL field.

If the IP address is “1 9 2 1 6 8 x x y y”, input “192.168.xx.yyy” into the URL field.

If the IP address is “1 9 2 1 6 8 x y y y”, input “192.168.x.yyy” into the URL field.

This unit’s WEB Setup information screen will open in the Internet browser.



6. Click the “My Favorites” tab and input the name and URL of the Internet radio station.
7. Click “Save” to finish registering that Internet radio station.

Registering a station by operating the unit

You will need the name and URL of the radio station to add during the storing procedure, so check them in advance.

Input radio station information directly into “My Favorites” of the unit.

1. Press the NET button.
2. Use the direction (^ / v / < / >) buttons to select “My Favorites” on the display and press the ENTER button.
3. Press the direction (^ / v / < / >) buttons to select a number to which a radio station is not registered, and press and hold the MENU button.
4. Use the direction (^ / v) buttons to select “Create new station” and press the ENTER button. “URL” appears on the display.
5. Press the ENTER button.
6. Input the name of the radio station.
 - For information on how to input characters, see “Inputting characters” under “Various settings”.
7. Input the URL of the radio station.

Playing a registered radio station

1. Press the NET button.
2. Use the direction (^ / v / < / >) buttons to select “My Favorites” on the display and press the ENTER button.

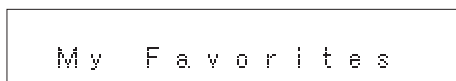

3. Use the direction (^ / v / < / >) buttons to select a radio station and press the ENTER button. Playback starts.

To remove a radio station that has been added:

1. Select the radio station in the “My Favorites” and press and hold the MENU button.
2. Use the direction (^ / v) buttons to select “Delete from My Favorites” and press the ENTER button. A message requesting confirmation appears.
3. Press the ENTER button.

To change the name or URL of a radio station that has been added:

1. Select the radio station in the “My Favorites” and press and hold the MENU button.
2. Use the direction (^ / v) buttons to select “Rename this station” and press the ENTER button.
3. Input the name of the radio station.
 - For information on how to input characters, see “Inputting characters” under “Various settings”.
4. Input the URL of the radio station.

Playing tracks stored on a USB storage device

Basic operations

You can connect a USB storage device to the USB port on the front or rear panel and play music files on it.

- For information on supported USB storage devices and file formats, see “Compatible devices/media/file formats”.
- By default, the power supply function for the USB port on the front panel is enabled. For details on the power supply function and information on its setting, see “SleepCharge” under “Menu settings” under “Various settings”.

1. Press the USB button repeatedly to select “USB(F)” or “USB(R)” on the display.

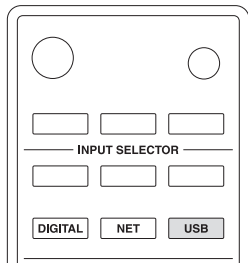

- To use the USB port on the front panel, select “USB(F)”; to use the one on the rear panel, select “USB(R)”.
2. Connect a USB storage to the selected USB port.

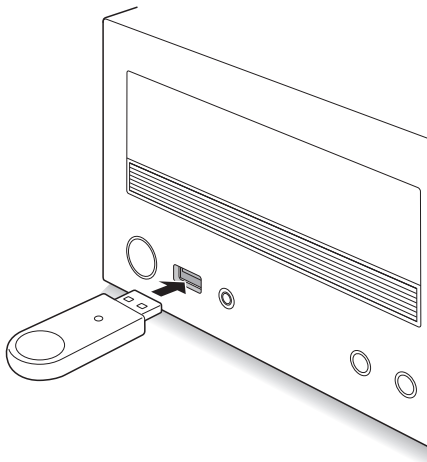

When a USB storage is detected, its volume label will be displayed.

- Depending on the USB storage device, reading data from it may take some time.
- When there is no compatible music file format on a USB storage, “No Item” will be displayed.
- If “No storage” appears, reconnect the USB storage device.

3. Press the ENTER button.
The name of the track or folder appears.
4. Use the direction (▲/▼) buttons to select a track or a folder and press the playback (▶) button.
Playback starts.

- To return to the previous display, press the RETURN button.
- When a folder is selected, the first track in that folder will start playing back.
- You can also select a folder and then press the ENTER button to select tracks inside that folder.
- Only the music files in the same level of the folder are played. You can also set repeat playback mode to Full and play all tracks stored on the USB storage device.

■ **Stop:** Press the stop (■) button.

■ **Pause:** Press the pause (⏸) button. Playback resumes when you press the pause (⏸) button again.

■ **Skip:** Press the skip (⏮/⏭) buttons to skip to tracks before or after the current track. Keep pressing until the desired track is selected.

- During playback, press the ⏮ button once to return to the beginning of the current track. To return to the beginning of the previous track, keep pressing the ⏮ button.

■ **Search backward/forward:** During playback, press the search (⏪/⏩) buttons to search backward/forward. Release the button when you find the desired part. Playback resumes from that point.

■ **Information shown on the display:** Press the DISPLAY button repeatedly during playback to change the information shown on the display.

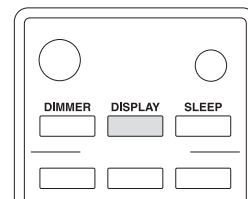



Title (if file has ID3 tag) → Artist (if file has ID3 tag) → Album (if file has ID3 tag) → Elapsed time of current track → Playback time of current track → File format, sampling rate and bit rate

Random playback

Plays back audio files in the folder repeatedly in random order.

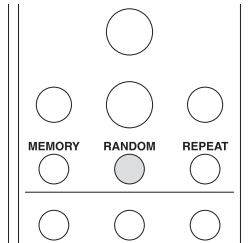
1. Press the RANDOM button.



 appears on the display.

■ **Ending random playback:** Press the RANDOM button again.

- Random playback is cancelled if you put the unit into standby mode, disconnect the USB storage device or start repeat playback.

Repeat playback

1. Press the REPEAT button repeatedly to select the repeat modes.

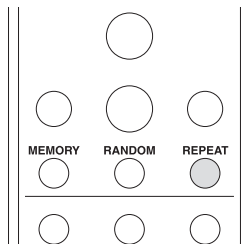

The following icons appear on the display:

 : Repeats all tracks in the USB storage device.

 : Repeats one track.

 : Repeats tracks in the folder.

■ **Ending repeat playback:** Press the REPEAT button repeatedly until the repeat icon disappears.

- Starting Random playback cancels repeat playback temporarily. If you cancel the random playback, repeat playback mode resumes with the previous setting.

Listening to an iPod/iPhone

You can connect an iPod/iPhone to the USB port on the front panel and play music files on it.

- For information on supported iPod/iPhone, see “Compatible devices/media/file formats”.
- By default, the charging function for the USB port on the front panel is enabled. For details on the charging function and information on its setting, see “SleepCharge” under “Menu settings” under “Various settings”.

1. Press the USB button repeatedly to select “USB(F)” on the display.

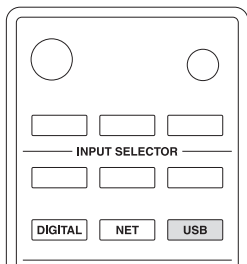

2. Connect the USB cable that comes with the iPod/iPhone to the USB port on the front of the unit.

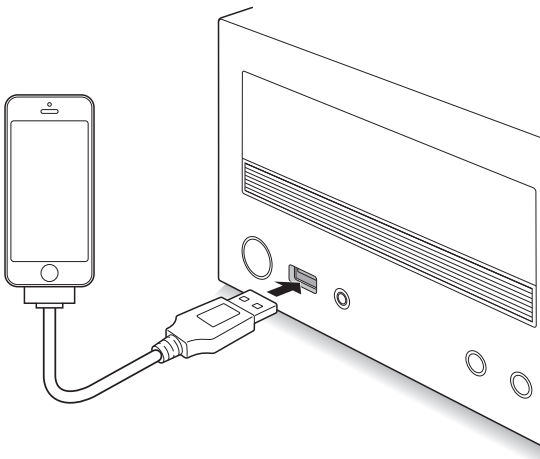

- If “No storage” appears, reconnect the iPod/iPhone.

3. Press and hold the stop (■) button to select the playback modes.

Extended mode: Content information appears on the display. In this mode, you operate the remote control of the unit.

Standard mode: In this mode, you operate both the iPod/iPhone and the remote control of the unit while looking at the iPod/iPhone screen.

- For information on remote control operation, see “Playing tracks stored on a USB storage device”.
- With some iPod/iPhone models and generations, certain buttons may not work as expected.

■ **Menu items in Extended mode:** When Extended mode is selected, the following menu items appear on the display. Use the direction (▲/▼) buttons to select the menu and press the ENTER button.

Playlists → Artists → Albums → Genres → Songs → Composers → Shuffle Songs → Now Playing

■ **Information shown on the display:** Press the DISPLAY button repeatedly during playback in the Extended mode to change the information shown on the display.

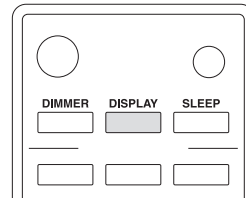

Title → Artist → Album → Elapsed time of current track → Playback time of current track → File format, sampling rate and bit rate

■ **Random playback:** Press the RANDOM button repeatedly to select the random modes. In Extended mode, the following icons appear on the display:

🎲 : Plays all tracks in the selected folder randomly.

📁 : Plays a randomly selected album when the selected folder contains multiple albums.

- To end the random playback, press the RANDOM button repeatedly until the random icon disappears.

■ **Repeat playback:** Press the REPEAT button repeatedly to select the repeat modes.

In Extended mode, the following icons appear on the display:

🔁 : Repeats all tracks.

🔁 : Repeats one track.

- Repeat playback and random playback can be used together.
- To end the repeat playback, press the REPEAT button repeatedly until the repeat icon disappears.

Listening to AM/FM radio

Tuning into a radio station

Tuning into stations automatically

1. Press the TUNER button repeatedly to select either "AM" or "FM" on the display.

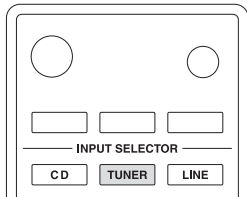

2. Press the ENTER button repeatedly until "AUTO" appears on the display.
3. Press ◀ TUN/TUN ▶ buttons to start Auto tuning.

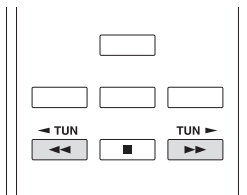

- Searching automatically stops when a station is found. When tuned into a radio station, the ▶◀ indicator on the display lights.

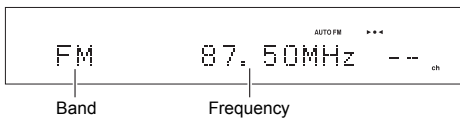

When the reception of FM broadcasts is poor: If the radio wave reception is weak or there is excess noise in your location, refer to "Tuning into stations manually" on the next page to change the reception setting to monaural. This can minimise the noise and audio interruptions.

Tuning into stations manually

If you tune into an FM radio station manually, it will be received in monaural sound.

1. Press the TUNER button repeatedly to select either "AM" or "FM" on the display.
2. Press the ENTER button repeatedly until "AUTO" on the display disappears.
3. Press ◀ TUN/TUN ▶ buttons to select the desired radio station.
 - The frequency changes by 1 step each time you press the button. The frequency changes continuously if the button is held down and stops when the button is released. Tune by looking at the display.
 - You can change the AM frequency step. See "AM Freq. Step" under "Menu settings" under "Various settings".

Tuning into stations by frequency

It allows you to directly enter the frequency of the radio station you want to listen to.

1. Press the TUNER button repeatedly to select either "AM" or "FM" on the display.
2. Press D.TUN button.

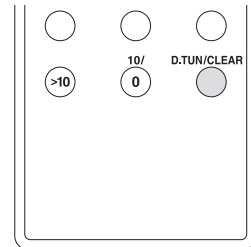

3. Using the number buttons, enter the frequency of the radio station within 8 seconds.
 - To enter 87.50 (FM), for example, press [8], [7], [5], [0]. If the entered number is incorrect, press the D.TUN button again 8 seconds or more later and re-enter the number.

Presetting an AM/FM radio station

It allows you to register up to 40 of your favorite AM/FM radio stations. Registering radio stations in advance allows you to tune into your radio station of choice directly.

Registering radio stations automatically

Only FM radio stations can be registered automatically.

- If you use the Auto Preset function, all registered radio stations will be deleted and replaced by new ones.
1. Press the TUNER button repeatedly to select “FM” on the display.
 2. Press the MENU button. Use the direction (\wedge/\vee) buttons to select “Tuner Setting” and press the ENTER button.

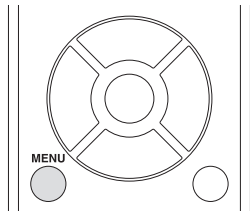

- To return to the previous display, press the RETURN button.
3. Use the direction (\wedge/\vee) buttons to select “AutoPreset” and press the ENTER button. A message requesting confirmation appears.
 - To cancel the operation, press the MENU button.
 4. Press the ENTER button. Auto Preset starts. Up to 40 stations can be registered in the order of frequency.

Registering radio stations manually

1. Tune into the AM/FM radio station you want to register.
2. Press the MENU button. Use the direction (\wedge/\vee) buttons to select “Tuner Setting” and press the ENTER button.
 - To return to the previous display, press the RETURN button.
3. Use the direction (\wedge/\vee) buttons to select “Preset Write” and press the ENTER button. The preset number on the display flashes.
 - To cancel the operation, press the MENU button.
4. Use the direction (\lt/\gt) buttons to select the preset number and press the ENTER button. When the registration is complete, “Complete” appears on the display.
 - If a station has already been stored in the selected preset, the message “OverWrite ?” appears. To overwrite the previously stored station, press the ENTER button. To not overwrite the previously stored station, press the MENU button.

Selecting preset stations

1. Press the TUNER button repeatedly to select either “AM” or “FM” on the display.
2. Press \blacktriangleleft PRESET/PRESET \blacktriangleright buttons to select a preset number.

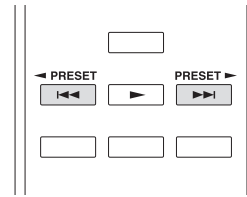

- You can also select by directly entering the preset number with the number buttons.

Naming a preset radio station:

1. Press the MENU button while a preset number is displayed, use the direction (\wedge/\vee) buttons to select “Tuner Setting”, and press the ENTER button.
2. Use the direction (\wedge/\vee) buttons to select “Name Edit” and press the ENTER button.
3. Input the name.
 - For information on how to input characters, see “Inputting characters” under “Various settings”.

Copying a preset radio station: You can copy preset radio stations to other preset numbers and arrange them into the desired order.

1. Press the MENU button while a preset number is displayed, use the direction (\wedge/\vee) buttons to select “Tuner Setting”, and press the ENTER button.
2. Use the direction (\wedge/\vee) buttons to select “Preset Copy” and press the ENTER button. The preset number on the display flashes.
3. Use the direction (\lt/\gt) buttons to select the preset number of the copy destination and press the ENTER button.

When the radio station has been copied, “Complete” appears on the display.

- If a station has already been stored in the selected preset, the message “OverWrite ?” appears. To overwrite the previously stored station, press the ENTER button. To not overwrite the previously stored station, press the MENU button.
- To keep a radio station registered to the preset number of the copy destination, copy it to another preset in advance.

Erasing a preset radio station:

1. Press the MENU button while a preset number is displayed, use the direction (\wedge/\vee) buttons to select “Tuner Setting”, and press the ENTER button.
2. Use the direction (\wedge/\vee) buttons to select “Preset Erase” and press the ENTER button. A message requesting confirmation appears.
 - To cancel the operation, press the MENU button.
3. Press the ENTER button. When the radio station has been erased, “Complete” appears on the display.

Receiving RDS

Press the DISPLAY button repeatedly to display the following RDS information.

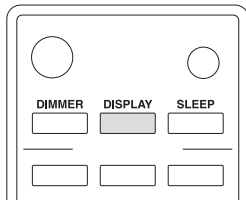

Frequency and preset number → Preset name →
Program Service Name → Radio Text (if available)

- If the selected preset has no name, it will be skipped and the next Program Service Name will be displayed.

What is RDS?

RDS stands for Radio Data System and is a method of transmitting data in FM radio signals.

This unit supports and displays the Program Service Name (PS) and Radio Text (RT) types of RDS data.

The RDS indicator appears on the display when the unit is tuned to an FM station that supports RDS.

- RDS is only available in areas where RDS broadcasts are available.
- If the signal from an RDS station is weak, RDS data may be displayed intermittently or not at all.
- The message "Waiting..." may appear while the RT data is being received.

Using a home network

Playing music stored on DLNA-compatible devices

Digital Living Network Alliance (DLNA) can be referred to as a technology standard or the industry group to develop the technology standard to interconnect and use AV components, PCs and other devices in a home network. The unit allows you to use DLNA to play music files stored on a PC or a hard disk connected to your home network (NAS device).

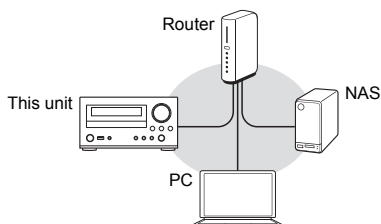

- You must connect the unit and PC or NAS to the same router.
- You can play music files on a NAS device provided with a DLNA server function or a PC installed with a player provided with a DLNA server function, such as Windows Media Player 11 or 12. To stream music files through Windows Media Player 11 or 12, you must configure its streaming settings.

Setting up Windows Media Player

Windows Media Player 11

1. Turn on your PC and start Windows Media Player 11.
2. In the "Library" menu, select "Media Sharing" to open a dialog box.
3. Select the "Share my media" check box and click "OK" to display the compatible devices.
4. Select this unit and click "Allow".
 - The icon of this unit is checked when you click it.
5. Click "OK" to close the dialog box.

Windows Media Player 12

1. Turn on your PC and start Windows Media Player 12.
2. In the "Stream" menu, select "Turn on media streaming" to open a dialog box.
 - If media streaming is already turned on, select "More streaming options..." in the "Stream" menu to list players in the network, and then go to step 4.
3. Click "Turn on media streaming" to list players in the network.
4. Select this unit in "Media streaming options" and check that it is set to "Allowed".
5. Click "OK" to close the dialog box.
6. When using the Play To feature, open the "Stream" menu and check that "Allow remote control of my Player..." is checked.

Playing music files by operating the unit

You can play music files stored on a server by operating the unit.

1. Turn on the server.
2. Press the NET button.

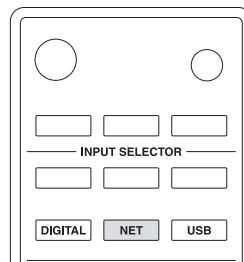

3. Use the direction ($\wedge/\vee/ </>$) buttons to select "DLNA" on the display and press the ENTER button.



4. Use the direction (\wedge/\vee) buttons to select the server and press the ENTER button. The server folder will be shown.
 - You can check the server name of your PC from the PC properties.
 - To return to the previous display, press the RETURN button.
 - Depending on server functions or sharing settings, some contents might not be shown. See the operation manual of the server.
 - This unit cannot access photographs or videos on a server.
5. Use the direction (\wedge/\vee) buttons to select the audio file that you want to play, and press the ENTER button or playback (\blacktriangleright) button.
 - Searching forward/backward and pausing functions might not work with some servers.
 - If information cannot be retrieved from a server, "No Item" will appear on the display. If this occurs, check the server and network connections.
 - Immediately after an audio file is added to a Windows Media Player library, that file might not appear in this unit's audio file list. This is because the Windows library index has not been refreshed. You can either wait for the index to refresh automatically, or you can manually rebuild the index. See Windows online help for instructions about how to do this.

About basic operations

You can also perform operations such as stopping or selecting a track with the stop (■), pause (⏸), skip (⏮/⏭), and search (⏪/⏩) buttons.

About repeat/random playback

You can perform these operations with the REPEAT button and the RANDOM button.

About information on the display

If you press the DISPLAY button repeatedly during playback, you can switch the information on the display between various details, including the title and artist name.

Using the Play To feature

Using a controller device or PC that complies with the DLNA standard, you can play music files stored on a server.

In this section, we explain the steps to perform remote playback with Windows Media Player 12.

1. Turn this unit on.
2. Turn on your PC and start Windows Media Player 12.
3. Select the file that you want to play in Windows Media Player 12 and right-click it.

This opens a pop-up menu.

- To use the Play To feature with audio files on a different server, open that server from the list that appears under "Other Libraries" and select the audio file that you want to play.

4. Click the "Play to" and select this unit from the Play To list.

Open the Windows Media Player 12 "Play To" dialog box, and start playback from this unit.

Use the "Play To" dialog box to control remote playback.

- Remote playback is not possible when you are performing a different operation that uses the network on the unit or playing a music file stored on an iPod/iPhone on the unit.

5. Adjust the volume using the volume bar on the "Play To" dialog box.
 - The default maximum volume level is 38. You can change the level using WEB Setup. For information on how to access WEB Setup, see "Registering your favorite radio stations (My Favorites)" under "Listening to Internet radio".
 - Some times, the volume displayed on the "Play To" dialog box may differ from that appeared on the display of the unit.
 - When the volume is adjusted from the unit, the value is not reflected in the "Play To" dialog box.

Music streaming from a shared folder (Home Media)

A shared folder is configured in a network device such as a PC or a hard disk connected to your home network (NAS device) for access from other users. You can play music files in a shared folder on your PC or NAS device connected to the same home network as that of this unit.

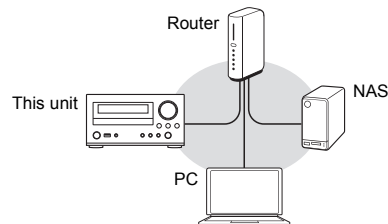

- You must connect the unit and PC or NAS to the same router.
- To play tracks in a shared folder, you must configure the relevant settings of the PC or NAS in advance. For information on the setup, see the instruction manual for each device. In this section, we explain the setup with Windows® 7 and Windows® 8.

Setting up Windows

Configuring the sharing options

1. Turn the PC on.
2. Select "Choose homegroup and sharing options" in the "Control Panel".
 - If the menu is not displayed, check that "View by" is set to "Category".
3. Select "Change advanced sharing settings".
4. Check that the following radio buttons are selected in the "Home or Work" (Windows 7) or "Private" and "All Networks" (Windows 8):
 - "Turn on network discovery"
 - "Turn on file and printer sharing"
 - "Turn on sharing so anyone with network access can read and write files in the Public folders"
 - "Turn off password protected sharing"
5. Select "Save changes" and click "OK" in the dialog box.

Creating a shared folder

1. Select and right-click the folder to share.
2. Select "Properties".
3. Select "Advanced Sharing" on the "Sharing" tab.
4. Select the "Share this folder" check box and click "OK".
5. Click "Share" for "Network File and Folder Sharing".
6. Select "Everyone" from the pull-down menu. Click "Add" and click "Share".
 - To set a user name and password to a shared folder, set "Permissions" in "Advanced Sharing" in the "Sharing" tab.
 - Check that a workgroup is set.

Playing back

You can play music files in a shared folder stored on each device by operating the unit.

1. Press the NET button.
2. Use the direction (^ / v / < / >) buttons to select "Home Media" on the display and press the ENTER button.

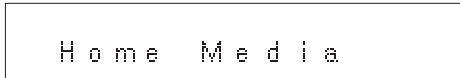

3. Use the direction (^ / v) buttons to select the server that you want to use and press the ENTER button.
 - You can check the server name of your PC from the PC properties.
 - To return to the previous display, press the RETURN button.
4. Use the direction (^ / v) buttons to select the shared folder that you want to use and press the ENTER button.
5. When a user name and password are required, input the necessary account information.
 - For information on how to input characters, see "Inputting characters" under "Various settings".
 - After inputting the account information once, it is saved, so you will not need to input it the next time.
 - Use the account information set when you created the shared folder.
6. Press the direction (^ / v) buttons to select the music file to play and press the ENTER button or playback (▶) button.
Playing starts.

About basic operations

You can also perform operations such as stopping or selecting a track with the stop (■), pause (⏸), skip (⏮/⏭), and search (⏪/⏩) buttons.

About repeat/random playback

You can perform these operations with the REPEAT button and the RANDOM button.

About information on the display

If you press the DISPLAY button repeatedly during playback, you can switch the information on the display between various details, including the title and artist name.

Various settings

Setting the sound quality

1. Press the TONE/BAL button repeatedly to select the setting you want to adjust.

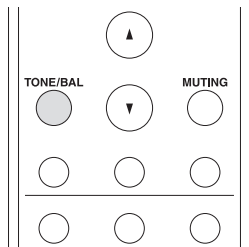

2. Press the direction (</>) buttons to adjust the setting.

■ Bass

Adjusts the bass level.

–3 to +3 (default setting: 0)

■ Treble

Adjusts the treble level.

–3 to +3 (default setting: 0)

■ Balance

Adjusts the audio output balance between the left and right speakers.

L7 to R7 (default setting: 0)

■ PM.Bass (Phase Matching Bass)

Suppresses phase shift in the midrange to enhance smooth and powerful bass sound.

On (default setting)

Off

- “BASS” appears on the display when “On” is selected.
- “Direct” is disabled when “On” is selected.

■ Direct

When the Direct function is on, the tone controls are bypassed, so you can enjoy a pure sound.

On

Off (default setting)

- “DIRECT” appears on the display when “On” is selected.
- “Bass”, “Treble” and “PM.Bass” are disabled when “On” is selected.

Inputting characters

Follow these procedures to input characters when using the “NET Setting” and “My Favorites” menus, for example.

1. Use the direction (</>) buttons to select a character or symbol and press the ENTER button. Repeat this procedure to input more.

The following characters can be used.

a

a	b	c	d	e	f	g	h	i	j	k	l	m
n	o	p	q	r	s	t	u	v	w	x	y	z
1	2	3	4	5	6	7	8	9	0	-	^	\
,	.	/	;	:	@	[]	S	p	a	c	e
S	h	i	f	t	<	>	B	S	O	K		

b

A	B	C	D	E	F	G	H	I	J	K	L	M
N	O	P	Q	R	S	T	U	V	W	X	Y	Z
!	"	#	\$	%	&	`	()	_	=	~	
<	>	?	+	*	'	{	}	S	p	a	c	e
S	h	i	f	t	<	>	B	S	O	K		

- **Shift***: Changes the characters shown. (a → b)
 - **Space**: Inputs a blank space that is one character wide. (It is displayed as SP in some cases.)
 - **← (left) / → (right)**: Moves the cursor in the text input area.
 - **BS (backspace)****: Deletes characters to the left of the cursor. Move the cursor left.
 - **ä**: When this is displayed, you can select it to change the characters shown to umlaut characters.
- * You can also change them by pressing the [>10] button.
- ** You can press the CLEAR button to delete all the input characters at once.

2. After completing input, use the direction (</>) buttons to select “OK” and press the ENTER button.

Sleep timer

With the sleep timer, you can set the unit so that it automatically turns off after a specified period.

1. Press the SLEEP button repeatedly to select the time.

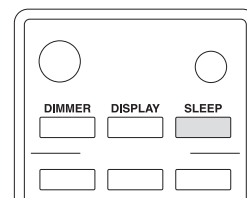

- With the SLEEP button, you can set the sleep time from 90 to 10 minutes in 10 minute increments. The setting is complete 5 seconds after you have displayed the desired time.
- When the sleep timer has been set, “SLEEP” appears on the display.

■ **Checking the remaining time:** If you press the SLEEP button, the remaining time until the unit will be put into standby mode appears.

■ **To cancel the sleep timer:** press the SLEEP button repeatedly until “SLEEP” disappears.

Menu settings

Follow the procedures below to display the menu and change settings.

ASb, SleepCharge, Tuner Setting, Sel Change, M.OPT, MP3 Setting, NET Setting, Update

- Different items are displayed depending on the input source.

1. Press the MENU button.

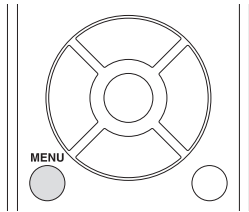

2. Use the direction (∧/∨) buttons to select the setting you want to change and press the ENTER button.
 - To return to the previous display, press the RETURN button.
 - If a submenu appears, press the direction (∧/∨) buttons to select a submenu item and press the ENTER button.
 - To cancel the operation, press the MENU button.
3. Use the direction (</>) buttons to change setting values and press the ENTER button.
4. After you complete making settings, press the RETURN button to quit the menu.

■ ASb (Auto Standby)

The unit will automatically enter standby mode if there is no operation for 2 hours with no audio signal input.

On (default setting)

Off

- “ASb” appears on the display when “On” is selected.

■ SleepCharge

You can specify how the power is fed to your USB device when the unit is in standby mode. Only the USB port on the front panel is provided with the charging function and power supply function.

On (default setting): If you connect USB device, charging or power supply will start.

Off: Your USB device is not charged.

- The charging function does not support the following types of the iPod/iPhone:
iPod touch (1st, 2nd and 3rd generation), iPod nano (2nd and 7th generation), iPhone 3GS, iPhone 3G, iPhone
- If you connect the USB device while the unit is in the standby mode, the message “ReadyCharging” appears, and then message “Charging” appears when charging or power supply starts.
- If you disconnect the USB device while “ReadyCharging” appears, the unit does not enter the standby mode. To put the unit into standby mode, press the ⏻ button to turn on the unit, and press the ⏻ button again.

- If the iPod/iPhone completely runs out of battery, charging might not work. In that case you need to turn the power on again.
- When the “SleepCharge” setting is set to “On”, the power consumption slightly increases in standby mode.

■ Tuner Setting

You can change the setting of AM/FM radio.

To set this item, switch the input source to “AM” or “FM”.

AM Freq. Step: Changes the AM radio frequency step.

AM Step 9kHz (default setting): The frequency is adjusted in increments of 9 kHz.

AM Step 10kHz: The frequency is adjusted in increments of 10 kHz.

For information on other settings, see “Listening to AM/FM radio”.

■ Sel Change (Selector Change)

When connecting an Onkyo RI Dock to the unit, you must switch the input display to “DOCK” in order for the devices to work properly with each other.

Before switching the input display to “DOCK”, select an input source to be used as “DOCK” from among “LINE1”, “LINE2”, “OPTICAL”, and “COAXIAL”.

- You can change only one of the four input sources to “DOCK” at a time.

Line1, Line2, Optical, Coaxial



Dock

■ M.OPT (Music Optimizer)

MP3s and other files that use irreversible compression formats have reduced audio quality compared to the original sound sources due to their compression. Use M.OPT to optimize compressed audio. This function only works with digital audio input signals with a sampling rate below 48 kHz.

To set this item, switch the input source to “CD”, “USB(F)”, “USB(R)”, “OPTICAL”, “COAXIAL” or any of the input sources that can be selected by pressing the NET button.

Off (default setting)

On

- “M.OPT” appears on the display when “On” is selected.

■ MP3 Setting

You can set how MP3/WMA file information is shown and how MP3/WMA discs are played back, for example.

To set this item, switch the input source to “CD”.

BAD NAME: Set how MP3/WMA file information is shown.

- Regardless of the setting, characters that cannot be shown in ID3 tag information are replaced with asterisks (*).

Replace: If a track or folder name contains a character that cannot be shown, “File_n” or “Folder_n” (with “n” being the track/folder number) will be shown instead.

Not (default setting): Characters that can be shown are shown and characters that cannot be shown are replaced with asterisks (*).

ID3 VER.1: Set how ID3 Version 1.0/1.1 tag information is shown.

Read (default setting): The unit will load tag information and show it.

Not Read: Tag information will not be shown.

ID3 VER.2: Set how ID3 Version 2.2/2.3/2.4 tag information is shown.

Read (default setting): The unit will load tag information and show it.

Not Read: Tag information will not be shown.

CD EXTRA: This preference applies to CD Extra discs and determines whether music in the audio session or MP3/WMA files in the data session are played.

Audio (default setting): Music CDs will be played.

MP3: MP3/WMA files are played.

JOLIET: Set how MP3/MMA data recorded in JOLIET format are read. Normally, you do not need to change the setting.

- SVD (Supplementary Volume Descriptor) supports characters other than alphabet characters and numbers. It also supports long file/folder names.

Use SVD (default setting): SVD data is read.

ISO9660: Data is read in ISO9660 format.

HIDE NUMBER: The unit can hide numbers that are attached to the beginnings of track and folder names.

Disable (default setting): Such numbers will be shown.

Enable: Such numbers will not be shown.

- When an MP3/WMA disc is made on a PC, the ordinary file playback order is not determined. By adding numbers like 01, 02 and 03 to the beginnings of MP3/WMA file names, however, they can be played back in numerical order.

STOP KEY: You can set the function of the stop (■) button on the main unit.

All Folder: Pressing the stop (■) button activates all folder mode.

Navigation (default setting): Pressing the stop (■) button activates navigation mode.

Disable: Pressing the stop (■) button does not activate all folder or navigation mode.

■ NET Setting

Make the settings according to the characteristics of the network to which this unit is being connected.

- If "DHCP" is set to "Enable" (default setting), "IP Address", "Subnet Mask", "Gateway" and "DNS Server" settings will appear, but cannot be changed. If "DHCP" is set to "Disable", "IP Address", "Subnet Mask", "Gateway" and "DNS Server" will appear and must be set.
- When you press the RETURN button while viewing the "NET Setting" submenu, "Network Save?" will appear. Press the ENTER button to save the settings. If you press the RETURN button, the menu will finish without saving the setting changes.

IP Address: View/set the IP address.

MAC Address: View this unit's MAC address.

DHCP:

Enable (default setting)

Disable

Subnet Mask: View/set the subnet mask.

Gateway: View/set the default gateway.

DNS Server: View/set the DNS server address.

Proxy URL: Set the proxy server address.

Proxy Port: Set the proxy port number.

- This only appears when Proxy URL has been set.

■ Update

You can update the firmware of this unit. Do not put the unit in standby during an update.

- See "Firmware update" for update procedures.

Firmware update

Update the firmware via network or USB connection.

Visit the Onkyo website to download the latest firmware. (If no firmware is listed, no firmware update is available.)

Limitation of liability

The program and accompanying online documentation are furnished to you for use at your own risk. Onkyo will not be liable and you will have no remedy for damages for any claim of any kind whatsoever concerning your use of the program or the accompanying online documentation, regardless of legal theory, and whether arising in tort or contract. In no event will Onkyo be liable to you or any third party for any special, indirect, incidental, or consequential damages of any kind, including, but not limited to, compensation, reimbursement or damages on account of the loss of present or prospective profits, loss of data, or for any other reason whatsoever.

You can check the current firmware version. Follow the procedures below.

1. Press the MENU button.

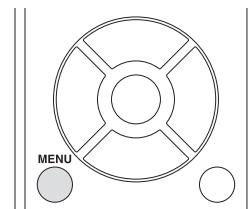

2. Use the direction (∧/∨) buttons to select "Update" and press the ENTER button.
3. Use the direction (∧/∨) buttons to select "Version" and press the ENTER button.

■ Updating the firmware via network

You can update the firmware by connecting the unit to a network.

Precautions when updating the firmware

- Confirm that the unit is on and connected to a network.
- While updating, never disconnect or turn off this unit.
- While updating, never disconnect and reconnect the LAN cable.
- While updating, never disconnect and reconnect the power cord.
- Do not access this unit from a PC while updating.
- Updating takes about five minutes to be completed.
- Settings you made are retained after updating.
- Before starting an update, stop the Internet radio, iPod/iPhone, USB device, server or any other device that is playing audio.

Update procedures

1. Press the MENU button.
2. Use the direction (▲/▼) buttons to select "Update" and press the ENTER button.
 - Wait for a while if "Not Available" is displayed and "Update" cannot be selected.
3. Use the direction (▲/▼) buttons to select "CR via NET?" and press the ENTER button.
 - The option does not appear when no firmware update is available.
4. Select "UpdateStart?" and press the ENTER button. Updating starts.
5. "Completed" appears on the display when updating is completed.
6. Press the ⏻ ON/STANDBY button on the front panel to put the unit into standby.
 - Do not use the ⏻ button on the remote control for this operation.
 - If you do nothing for three minutes, the unit will enter standby automatically.

The update is complete. The unit's firmware has been updated to the latest version.

When an error message appears

When an error occurs, "Error!! *_**" or an error message appears on the display of this unit. (Letters and numbers appear in place of the asterisks.) Refer to the descriptions below to check the meaning.

Error code

*-10, *-20: The LAN cable could not be recognized. Connect the LAN cable properly.

-11,-13,*-21,*-28: Internet connection could not be established. Check the following points.

- Confirm that the IP address, subnet mask, gateway address and DNS server setting are correct.
- Confirm that the router is turned on.
- Confirm that the unit and router are connected with a LAN cable.
- Check the router setting. For the setting, see the instruction manual of the router.

- This unit may fail in network connection if your network environment does not allow multiple device connections. Consult your Internet service provider (ISP).
- You need a router separately if your modem does not have the router function. Depending on your network connection environment, you need to configure the proxy server. For information on the configuration, consult the document provided by your carrier or ISP provider.
- If you still cannot connect to the Internet, the DNS server or proxy server may be temporarily down. Check the service status with your ISP provider.

Others: Disconnect and reconnect the power cord, and retry updating.

■ Updating the firmware via USB connection

Use the USB port to update the firmware.

- You need a 32 MB or larger capacity USB flash drive for updating.

Precautions when updating the firmware

- Before updating, stop playback and disconnect anything connected to the USB ports.
- While updating, never put the unit into standby mode, or disconnect the power cord or the USB flash drive being used for the update.
- Do not access this unit from a PC while updating.
- Updating takes about five minutes to be completed.
- Settings you made are retained after updating.

Update procedures

1. Connect a USB flash drive to the PC that you are using and delete any files on it.
2. Download the firmware file to the PC from our website. Decompress the downloaded file on the PC.
 - Do not change the names of the decompressed files.
3. Copy the decompressed files to the root folder of the USB flash drive.
 - Do not copy any files other than the decompressed files. Do not copy the compressed file.
4. Confirm that this unit is on.
5. Connect the USB flash drive with the decompressed files to the USB port.
6. Press the USB button repeatedly to select the port to which the USB flash drive is connected from "USB(F)" (front panel) and "USB(R)" (rear panel).

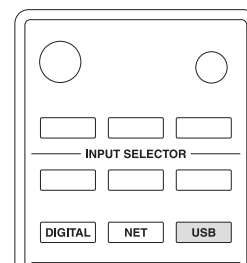

“Now Initializing...” appears on the display, followed by the name of the USB flash drive.

- Loading the USB flash drive takes about 20 to 30 seconds.
7. Press the MENU button to display the menu and use the direction (∧/∨) buttons to select “Update” and press the ENTER button.
 8. Use the direction (∧/∨) buttons to select “CR via USB?” and press the ENTER button.
 - This selection will not appear (and cannot be selected) if the flash drive does not contain firmware that can be used to update the unit.
 9. Select “UpdateStart?” and press the ENTER button. The unit firmware starts to be updated.
 10. After “Completed” appears, disconnect the USB flash drive.
 11. Press the ⏻ ON/STANDBY button on the front panel to put the unit into standby.
 - Do not use the ⏻ button on the remote control for this operation.
 - If you do nothing for three minutes, the unit will enter standby automatically.

The update is complete. The unit’s firmware has been updated to the latest version.

When an error message appears

When an error occurs, “Error!! *_**” or an error message appears on the display of this unit. (Letters and numbers appear in place of the asterisks.) Refer to the descriptions below to check the meaning.

Error code

***-10, *-20:** The USB flash drive could not be recognized. Confirm that the USB flash drive is securely connected to the USB port on the front of the unit.

***-14:** The root folder of the USB flash drive does not contain a firmware file or the firmware file is for a different model, for example.

Others: Disconnect and reconnect the power cord, and retry updating.

Troubleshooting

Before starting the procedure

Problems may be solved by simply turning the power on/off or disconnecting/connecting the power cord, which is easier than working on the connection, setting and operating procedure. Try the simple measures on both the unit and the connected device.

Restoring factory default settings

If this unit does not operate properly, follow the procedures below to restore it to the default settings that it had when shipped new from the factory. Doing this might correct the problem.

While the unit is on, press and hold the stop (■) button and press the ⏻ ON/STANDBY button.

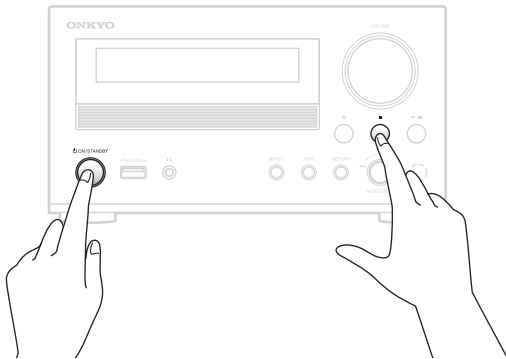

Power/Remote control

The unit does not turn on.

- Confirm that the power plug is securely plugged in to an outlet.
- Unplug the power cord once, wait five seconds and then plug it in again.

“Now Initializing...” appears on the display.

- If you turn on the unit when the input source is set to USB or NET, it takes about 20 to 30 seconds until the unit recognizes the input.

The unit turns off.

- When the Auto Standby function is enabled, the unit will enter standby automatically after a set amount of time. See “ASb (Auto Standby)” under “Menu settings” in “Various settings” to check the setting.

Remote control does not work.

- Make sure the batteries have been installed with the correct polarity (+/-).
- If the batteries are exhausted, replace both of them with new ones.
- Point the remote control at the front panel of the unit from a distance of less than about 5 m.
- The remote control will not work if there is an obstruction between it and the main unit. In this case, try changing the position.

- If a fluorescent light is near the unit, turn the light off.
- The unit is located behind the glass doors of a audio rack or cabinet.

Audio

There’s no sound.

- Make sure the correct input source is selected.
- If “MUTING” is displayed on the display, press the MUTING button to cancel muting.
- Make sure the speakers are connected correctly.
- Check all connections and correct as necessary.
- While headphones are connected, the speakers output no sound.
- If the headphones do not output audio, contact failure could be the cause. See the instruction manual for the headphones.

There is noise.

The sound quality is not good.

- Make sure that +/- of the speaker cables are connected correctly. Connect the speaker placed on the left hand side to the L terminal of the unit, and connect the right speaker to the R terminal.
- Make sure all audio connecting plugs are pushed in all the way.
- Place the unit as far away as possible from TVs and other devices that have strong magnetism.
- If you have any devices that emit high-intensity radio waves near the unit, such as a cellular phone that’s being used to make a call, the unit may output noise.
- The unit’s precision drive mechanism may emit a faint hissing sound while reading discs during playback or when searching for tracks. You may be able to hear this noise in extremely quiet environments.
- Audio performance will be at its best about 10 to 30 minutes after the unit has been turned on and had time to warm up.
- Using cable ties to bundle audio cables with speaker or power cables may degrade the sound quality, so don’t do it.

CD playback

Playback is not possible.

- If the disc is upside down, reload it with the labeled side up.
- If the disc is dirty, wipe it clean.
- If a blank disc is loaded, replace it with a disc that has recordings on it.
- Depending on the quality of the disc and the condition of the recording, playback of a CD-R/CD-RW might not be possible.
- This unit cannot play back unfinalized CD-R/CD-RW discs.

The sound skips.

- Vibrations will cause the sound to skip. Install this unit in a stable location.
- If the disc is dirty, wipe it clean.
- Do not use discs that are scratched or cracked.

■ Audio files

Playback is not possible.

- Check the file format. For information about playable file formats, see “File format” under “Compatible devices/media/file formats”.

The names of tracks, artists and albums are not shown.

- There is no ID3 tag information for the music file. Use a PC, for example, to prepare MP3 files with corrected ID3 tag information.

Some characters are not shown correctly.

- This unit cannot display symbols and full-size or double-byte characters (such as Japanese, Chinese, etc.) correctly. File names for MP3, WMA or other file formats should consist of alphanumeric characters. If the file information uses Japanese, Chinese or other double-byte characters, playback is possible but the name will not be shown correctly.

■ Internet radio

Cannot connect to the Internet.

- Confirm that a PC can connect to the Internet using the same network.
- Enter a correct network connection password.
- Check the settings of the network’s firewall.
- The station/podcast might not be available at the moment.
- The link for the station/podcast might be out of date.
- The number of registered users for the station/podcast might have already reached a limit, making it unavailable to the public.
- If the Internet connection speed is too slow, searching might take time.

Cannot listen to an Internet radio station or podcast.

- The broadcaster might have a temporary problem with their Internet connection.
- Confirm that your system is properly connected to the Internet.

■ USB storage device playback

Playback is not possible.

- Make sure that USB storage device and USB cable are securely plugged to the USB port of this unit.
- Remove the USB storage device from the unit once, and then try re-connecting.
- Performance of the hard disk that receives power from the USB port of the unit is not guaranteed.
- Depending on the type of format, the playback may not be performed normally. Check the type of the file formats that is supported.
- USB storage device with security functions may not be played.
- The unit supports USB storage devices that support the USB Mass Storage Class. However, playback may not be possible with some USB storage devices even if they conform to the USB Mass Storage Class.

- Check that the format of the USB storage device is FAT16 or FAT32.
- USB flash drives with an internal USB hub are not supported.

■ iPod/iPhone

Playback is not possible.

- Disconnect the iPod/iPhone from the USB port, wait a few seconds, and connect it again.
- Updating to the latest iPod/iPhone software might resolve the problem.

Cannot operate the iPod/iPhone.

- Make sure the iPod/iPhone is not locked.
- You cannot adjust the unit volume using an iPod/iPhone.

The RI functions don’t work properly.

- Make sure the RI cable is connected correctly.
- Try resetting your iPod/iPhone.

■ Charging Mode

The charging mode does not work.

- Make sure the “SleepCharge” function is set to “On”.
- The charging function does not support the following types of the iPod/iPhone:
iPod touch (1st, 2nd and 3rd generation), iPod nano (2nd and 7th generation), iPhone 3GS, iPhone 3G, iPhone
- Check if the iPod/iPhone completely runs out of battery. If it completely runs out of battery, charging will start after the unit is turned on again.
- The unit supports USB storage devices that support the USB Mass Storage Class. However, some of the USB devices that meet the USB Mass Storage Class may not be supplied power.

■ AM/FM radio

Reception is noisy.

Cannot tune into radio stations.

- Check the antenna connections.
- Change the position of the antenna.
- Move the antenna away from a TV, computer, power cords and speaker cables.
- Cars or airplanes can cause noisy interference.
- The radio signal will be weakened if it has to pass through a concrete wall before reaching the antenna.
- Try setting FM mode to mono.
- When listening to an AM station, noise may be heard when you operate the remote control.
- When the radio wave reception is weak, we recommend that you install a commercially-available indoor or outdoor antenna. Contact your dealer for information on the installation of an outdoor antenna.
- If registered stations were lost due to power outage or other unexpected event, register them again.

RDS doesn’t work.

- The FM station you are tuned to doesn’t support RDS.
- Install an outdoor FM antenna.

- Change the position or direction of your outdoor FM antenna.
- Move the FM antenna as far away as possible from fluorescent lights.

■ DLNA

Cannot connect to the network.

- Check the settings of the network's firewall.
- Confirm that a DLNA server on the same network can connect to the network.
- Confirm that the password to connect to the DLNA server is correct.
- Confirm that the DLNA server is not shut down or in sleep mode.
- There might be a problem with the network authentication. Press the NET button to select "DLNA" again.

Cannot find a track.

- Add the track to the media library of Windows Media Player.
- Select this unit from the Windows device list.
- If the PC is using antivirus or security software, the unit might not be able to connect to it.

■ Home Media

Cannot find a folder/file.

- Make folder/file sharing settings.
- Add the file to the shared folder.
- Confirm that the password for the user account is correct.
- Check the file format.
- If the PC is using antivirus or security software, the unit might not be able to connect to it.

Onkyo is not responsible for damages (such as CD rental fees) due to unsuccessful recordings caused by the unit's malfunction. Before you record important data, make sure that the material will be recorded correctly.

The unit contains a microcomputer for signal processing and control functions. In very rare situations, severe interference, noise from an external source, or static electricity may cause it to lockup. In the unlikely event that this should happen, unplug the power cord, wait at least 5 seconds, and then plug it again.

Specifications

■ Amplifier section

Rated output power:	22 W at 4 ohms, 1 kHz, 2 ch driven of 0.4% (IEC)
THD+N (Total Harmonic Distortion+Noise):	0.4% (1 kHz, 1 W)
Damping factor:	58 (Front, 1 kHz, 8 Ω)
Input sensitivity and impedance (unbalance):	150 mV/47 kΩ (LINE)
Rated RCA output level and impedance:	150 mV/470 Ω (LINE OUT)
Frequency response:	10 Hz - 100 kHz±3 dB (LINE1)
Tone control characteristics:	±6 dB, 80 Hz (BASS) ±8 dB, 10 kHz (TREBLE) +8 dB, 30 Hz (PM.Bass)
Signal to noise ratio:	100 dB (LINE, IHF-A)
Speaker impedance:	4 Ω - 16 Ω
Headphone impedance:	16 Ω - 600 Ω
Rated output power for headphones:	150 mW at 33 ohms, 1 kHz, 2 ch driven of 0.4% (IEC)

■ Tuner section

FM tuning frequency range:	87.5 MHz - 108.0 MHz, RDS
AM tuning frequency range:	522 kHz - 1611 kHz
Preset channel:	40

■ CD

Signal readout:	Optical non-contact
Frequency response:	10 Hz - 20 kHz
Audio dynamic range:	96 dB
THD (Total Harmonic Distortion):	0.003 % (30 kHz LPF)
Wow and flutter:	Below threshold of measurability
Audio output/impedance (analog):	2.0 V (rms)/320 Ω

■ General

Power supply:	AC 220 - 230 V, 50/60 Hz
Power consumption:	75 W
No-sound power consumption:	35 W
Stand-by power consumption:	0.2 W
Dimensions (W × H × D):	215 mm × 119 mm × 331 mm
Weight:	5.0 kg

Audio inputs

Digital:	Optical: 1 Coaxial: 1
Analog:	LINE1, LINE2, AUX

Audio outputs

Analog:	LINE OUT
Subwoofer pre output:	1
Speaker outputs:	Main (L, R)
Phones:	1 (3.5 Ø)

Others

RI:	1
USB:	1 (Front)/1 (Rear)
Ethernet:	1

Specifications and features are subject to change without notice.

License and trademark information

iPhone, iPod, iPod classic, iPod nano and iPod touch are trademarks of Apple Inc., registered in the U.S. and other countries.

"Made for iPod" and "Made for iPhone" mean that an electronic accessory has been designed to connect specifically to iPod or iPhone respectively, and has been certified by the developer to meet Apple performance standards. Apple is not responsible for the operation of this device or its compliance with safety and regulatory standards.

Please note that the use of this accessory with iPod or iPhone may affect wireless performance.

Apple, the Apple logo, App Store and the App Store logo are trademarks or registered trademarks of Apple Inc., registered in the U.S. and other countries.

Android and Google Play are trademarks or registered trademarks of Google Inc.

Windows 7, Windows Media, and the Windows logo are trademarks or registered trademarks of Microsoft Corporation in the United States and/or other countries.

DLNA®, the DLNA Logo and DLNA CERTIFIED® are trademarks, service marks, or certification marks of the Digital Living Network Alliance.

DSD and the Direct Stream Digital logo are trademarks of Sony Corporation.

VLSC, Music Optimizer, DIDRC and WRAT are trademarks of Onkyo Corporation.

"All other trademarks are the property of their respective owners."

Compatible devices/media/file formats

Compatible devices/media

■ CD

Types of discs that can be played by this unit

CDs with the "COMPACT disc DIGITAL AUDIO" logo



CD-R and CD-RW discs that have been properly recorded and finalized using the music CD format.

CD-R and CD-RW discs that have been recorded with MP3/WMA files and properly finalized.

- If you try to play any other type of disc with this unit, loud noises that damage speakers or harm hearing could occur. Never try to play any type of disc other than those shown above.
- This unit might not be able to properly play Copy Control CDs, Dual Discs or other special CDs that do not conform to the Red Book CD standard. Operation and sound quality cannot be guaranteed when special discs are used in this unit. If playback of a special disc should cause trouble, contact the seller of the disc.
- Be sure to finalize discs created by CD recorders.
- Depending on the quality of the disc and the condition of the recording, playback might not be possible. For details, see the operation manual for the device you are using.

Precautions for use

- Do not use cracked discs because they could damage the unit.
- Never use commercially-available CD stabilizers. Doing so could make the disc unplayable or damage the unit.
- Do not use discs which have a special shape (such as hearts or octagons). These types of discs could cause malfunction of the unit.
- If a CD-R/CD-RW disc that has a printable label surface is left in this unit for a long time, it could stick to the inside and become extremely difficult to remove and possibly even cause the unit to malfunction. Always remove such discs and store them in cases when not in use. Moreover, avoid using discs that have just been printed because they are especially prone to sticking.
- Do not use discs with residue from cellophane tape, rental discs with labels which are peeling off, or discs with decorative labels. This type of disc could get stuck in the unit, or could damage the unit.

Handling discs

- Always load discs with their labeled sides up.
- Be careful when handling discs. If the side that contains the data (unlabeled side) is scratched, smudged with fingerprints or otherwise dirty or marred, errors could occur during playback.
- To remove a disc from its case, while pressing down on the center of the case, hold the disc by its edges.
- If you have any questions about how to handle a CD-R or CD-RW disc, contact the seller of the disc directly.

Disc storage

- After you finish using a disc, always put it back into its case for storage. Failure to do so could result in warping and scratches.
- Do not leave discs in places that are exposed to direct sunlight or that are very humid or hot. Doing so could cause discs to become deformed or degraded, making them unplayable.
- CD-R and CD-RW discs are more susceptible to the impacts of heat and ultraviolet rays than ordinary CDs. For this reason, do not leave them for long times in places that are exposed to direct sunlight or near devices that generate heat, for example.
- Always clean discs before storing them. Leaving a disc in an unclean state might result in skipping or degraded sound quality.

Maintenance

- If the side of the disc that has the data encoded on it (unlabeled side) becomes dirty with fingerprints or dust, use a soft cloth to wipe the surface from the center directly toward the edge.
- Never use record cleaners, antistatic treatments, thinners or similar chemicals to clean discs. Such chemicals could harm the surface of the disc.

Precautions when creating MP3/WMA discs using a PC

- Perform recording following the ISO9660 Level 2 file system. The supported directory depth is eight levels, the same as ISO9660 Level 1.
- Discs recorded with the hierarchical file system (HFS) cannot be played.
- The unit recognizes MP3 and WMA files by their file extensions, which are ".mp3" and ".wma", respectively. Always include the extension in the file name.
- Encode the WMA file with an application approved by Microsoft Corporation USA. The file may not playback correctly if encoded with an unapproved application.
- After recording a CD-R/CD-RW disc, close the session (complete disc creation). This unit cannot play back discs that have unclosed sessions.
- This unit can play back files from a maximum of 99 folders. Furthermore, the unit can recognize and play back a maximum of 399 folders (including the root folder) and files.
- Multiple sessions recorded on the same disc are not supported. Only the first session on such discs can be played back.
- This unit cannot play audio files with copyright protection from a disc.
- A disc with insufficient storage capacity may not playback properly.

■ USB storage device

The unit supports USB storage devices that support the USB Mass Storage Class.

- FAT16 and FAT32 formats are supported for USB storage devices.
- If a USB storage device is divided into multiple partitions, this unit will recognize them as separate volumes.
- This unit supports up to 20,000 files and 16 folder levels within a single folder.
- This unit does not support USB hubs or devices with USB hub functions. Never connect such devices to this unit.
- When a USB storage device is connected to the USB port (USB(R)) on the rear panel, the following files cannot be played:
 - WAV files with a bit rate of 176.4 kHz or higher
 - 5.6448 MHz DSD files
- If the connected media is not supported, "No storage" appears on this unit's display.
- This unit cannot play back audio files if copyright protection is used.
- If you connect an audio player that supports USB devices to the unit, information on the audio player's screen may differ from information on the unit's display. In addition, the unit does not support management functions provided by the audio player (music file classification, sorting, supplementary information, etc.)
- Do not connect PCs to this unit's USB ports. Audio from PCs cannot be input through this unit's USB ports.
- This unit might not be able to use media that is loaded into a USB card reader.
- Depending on the USB storage device and its contents, reading data from it might take some time.
- Depending on the USB storage device, the unit might not be able to read its data correctly or supply power properly.
- During the use of USB storage devices, please be aware that our company will take no responsibility should data be lost or changed, a USB storage device become damaged or other harm occur.
- We recommend backing up data saved on a USB storage device before using it with this unit.
- Performance of the hard disk that receives power from the USB port of the unit is not guaranteed.
- If your AC adapter is supplied with your USB storage device, connect the AC adapter to an AC outlet to use the device.

- When using an audio player powered by a battery, check that its remaining capacity is sufficient.
- This unit does not support USB flash drives with security functions.

■ iPod/iPhone

This unit can be connected to and used with the following iPod/iPhone models.

iPhone 5s, iPhone 5c, iPhone 5
 iPhone 4s, iPhone 4
 iPhone 3GS, iPhone 3G
 iPhone
 iPod touch (1st, 2nd, 3rd, 4th, and 5th generation)
 iPod classic
 iPod nano (2nd, 3rd, 4th, 5th, 6th, and 7th generation)

- This unit cannot output video from an iPod or iPhone.
- Use the USB cable supplied with the iPod or iPhone to connect it to the unit.
- If the unit or remote control buttons do not work properly with your iPod or iPhone, updating its software might solve the problem.

■ Network server

This unit supports the following network server.

Windows Media Player 11
 Windows Media Player 12
 Servers that comply with DLNA

- This unit supports up to 20,000 files and 16 folder levels within a single folder.
- The Digital Living Network Alliance (DLNA) is a group that is advancing the standardization of reciprocal connections and the exchange of audio, image, video and other data among PCs, game devices and digital household appliances over ordinary home networks (LAN). This unit complies with version 1.5 of the DLNA guidelines.
- Depending on the type of media server, this unit might not recognize it or be able to play audio files saved on it.

File format

■ CD

The unit can play CD-Rs/CD-RWs recorded in music CD (CD-DA) format or MP3/WMA format.

- Variable bit rate (VBR) is supported. However, the time and other information shown on the display during playback of a VBR file might be incorrect sometimes.

MP3

Extension	.mp3, .MP3
Standard	MPEG1 Audio Layer-3
Sampling Frequency	32 k/44.1 k/48 kHz
Bit rate	32 kbps–320 kbps or VBR

WMA

Extension	.wma, .WMA
Sampling Frequency	32 k/44.1 k/48 kHz
Bit rate	32 kbps–192 kbps or VBR

- WMA Pro, Lossless and Voice are not supported.
- Copyright-protected WMA files cannot be played back.

■ USB and Networks

This unit can play the following types of audio files over a USB or network connection.

- This unit supports gapless playback of a USB storage device in the following conditions.

When WAV, FLAC and Apple Lossless files are consecutively played back and they have the same format, sampling frequency, channels and quantization bit rate

- The Play To feature does not support the following:
 - Gapless playback
 - FLAC, Ogg Vorbis, DSD
- Variable bit rate (VBR) is supported. However, the time and other information shown on the display during playback of a VBR file might be incorrect sometimes.

MP3

Extension	.mp3, .MP3
Standard	MPEG-1/MPEG-2 Audio Layer-3
Sampling Frequency	8 k/11.025 k/12 k/16 k/22.05 k/24 k/32 k/44.1 k/48 kHz
Bit rate	8 kbps–320 kbps or VBR

WMA

Extension	.wma, .WMA
Sampling Frequency	8 k/11.025 k/16 k/22.05 k/32 k/44.1 k/48 kHz
Bit rate	5 kbps–320 kbps or VBR

- WMA Pro and Voice are not supported.

WMA Lossless

Extension	.wma, .WMA
Sampling Frequency	44.1 k/48 k/88.2 k/96 kHz
Quantization bit rate	16/24-bit

WAV

Extension	.wav, .WAV
Sampling Frequency	8 k/11.025 k/12 k/16 k/22.05 k/24 k/32 k/44.1 k/48 k/64 k/88.2 k/96 k/176.4 k/192 kHz
Quantization bit rate	8/16/24-bit

- WAV files contain uncompressed PCM digital audio.

AAC

Extension	.aac, .m4a, .mp4, .3gp, .3g2, AAC, M4A, .MP4, .3GP, .3G2
Standard	MPEG-2/MPEG-4 Audio
Sampling Frequency	8 k/11.025 k/12 k/16 k/22.05 k/24 k/32 k/44.1 k/48 k/64 k/88.2 k/96 kHz
Bit rate	8 kbps–320 kbps or VBR

FLAC

Extension	.flac, .FLAC
Sampling Frequency	8 k/11.025 k/12 k/16 k/22.05 k/24 k/32 k/44.1 k/48 k/64 k/88.2 k/96 k/176.4 k/192 kHz
Quantization bit rate	8/16/24-bit

Ogg Vorbis

Extension	.ogg, .OGG
Sampling Frequency	8 k/11.025 k/16 k/22.05 k/32 k/44.1 k/48 kHz
Bit rate	32 kbps–500 kbps or VBR

- Incompatible files cannot be played back.

LPCM (Linear PCM)

Sampling Frequency	44.1 k/48 kHz
Quantization bit rate	16-bit

- Playback only supported over a network.

Apple Lossless

Extension	.m4a, .mp4, .M4A, .MP4
Sampling Frequency	8 k/11.025 k/12 k/16 k/22.05 k/24 k/32 k/44.1 k/48 k/64 k/88.2 k/96 kHz
Quantization bit rate	16/24-bit

DSD

Extension	.dsf, .DSF
Sampling Frequency	2.8224 M/5.6448 MHz

ONKYO

Onkyo Corporation

Kitahama Chuo Bldg, 2-2-22 Kitahama, Chuo-ku, OSAKA 541-0041, JAPAN
<http://www.onkyo.com/>

The Americas

Onkyo U.S.A. Corporation

18 Park Way, Upper Saddle River, N.J. 07458, U.S.A.
For Dealer, Service, Order and all other Business Inquiries:
Tel: 201-785-2600 Fax: 201-785-2650
<http://www.us.onkyo.com/>

For Product Support Team Only:
1-800-229-1687
<http://www.us.onkyo.com/>

Europe

Onkyo Europe Electronics GmbH

Liegnitzerstrasse 6, 82194 Groebenzell, GERMANY
Tel: +49-8142-4401-0 Fax: +49-8142-4208-213
<http://www.eu.onkyo.com/>

Onkyo Europe Electronics GmbH (UK Branch)

Meridien House, Ground floor, 69 - 71 Clarendon Road, Watford, Hertfordshire, WD17 1DS, United Kingdom
Tel: +44 (0)8712-00-19-96 Fax: +44 (0)8712-00-19-95

China

Onkyo China Limited (Hong Kong)

Unit 1033, 10/F, Star House, No 3, Salisbury Road, Tsim Sha Tsui Kowloon, Hong Kong.
Tel: 852-2429-3118 Fax: 852-2428-9039
<http://www.hk.onkyo.com/>

Onkyo China PRC (Mainland)

1301, 555 Tower, No.555 West NanJing Road, Jing'an District, Shanghai, China 200041,
Tel: 86-21-52131366 Fax: 86-21-52130396
<http://www.cn.onkyo.com/>

Asia, Oceania, Middle East, Africa

Please contact an Onkyo distributor referring to Onkyo SUPPORT site.
<http://www.intl.onkyo.com/support/>

The above-mentioned information is subject to change without prior notice.
Visit the Onkyo web site for the latest update.

SN 29401815

(C) Copyright 2014 Onkyo Corporation Japan. All rights reserved.

F1408-0



* 2 9 4 0 1 8 1 5 *