

# INFRARED HEATER PANEL WITH LED LIGHT

## INSTRUCTION MANUAL

(EN + DE)

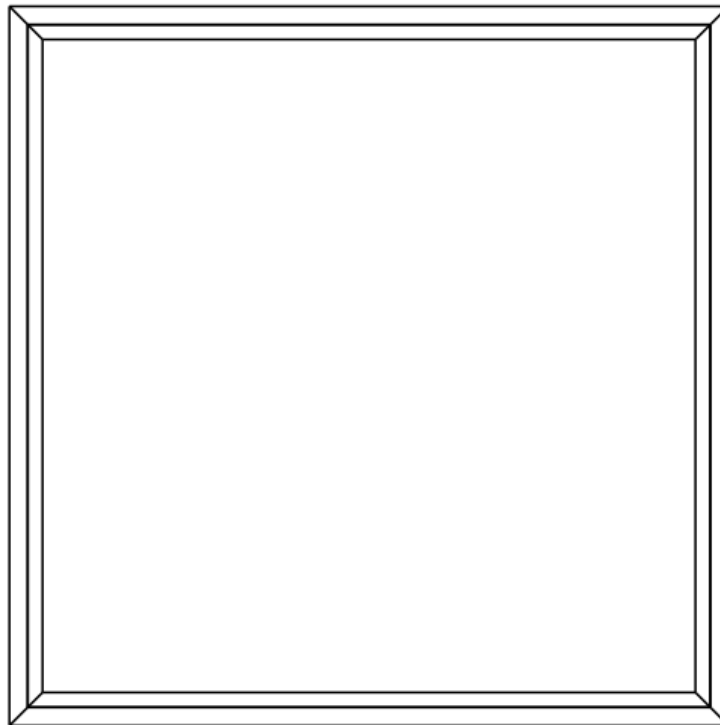

## SYMBOLS







### Warning

This signal word indicates a hazard with an average risk level which, if not avoided, can result in serious injury or death.



### Warning of electrical voltage

This symbol indicates dangers to the life and health of persons due to electrical voltage.

Symbols	Meaning
	This symbol located on the device indicates that it is prohibited to place objects (such as towels, clothes etc.) above or directly in front of the device. In order to avoid overheating and fire hazards, the device must not be covered.
	This symbol located on the device indicates dangers to the life and health of persons due to hot surface.
	This symbol located on the device indicates that it is prohibited to spray the device.
	This symbol located on the device and information marked indicates that operating manual must be observed.

## CONTENT

- 1 | WARNING & PRECAUTION
- 2 | FEATURES
- 3 | TECHNICAL INFORMATION
- 4 | SCOPE OF SUPPLY
- 5 | DEVICE STRUCTURE
- 6 | INSTALLATION
- 7 | THERMOSTAT
- 8 | TROUBLESHOOTING
- 9 | MAINTENANCE & SERVICING
- 10 | STORAGE
- 11 | TECHNICAL ANNEX
- 12 | DISPOSAL

## 1 | WARNING & PRECAUTION

**Read this manual carefully before starting or using the device. Always store the manual in the immediate vicinity of the device or its site of use!**

**Read all safety warnings and all instructions.**

Failure to follow the warnings and instructions may result in electric shock, fire and / or serious injury. Save all warnings and instructions for future reference.

### **Warning**

This series must be mounted above 1.8meters high!

Make sure the series you bought and install it in accordance to the tips in installation part!

### **Warning**

This appliance can be used by children aged from 8 years and above and persons with reduced physical, sensory or mental capabilities or lack of experience and knowledge if they have been given supervision or instruction concerning use of the appliance in a safe way and understand the hazards involved.

Children shall not play with the appliance. Cleaning and user maintenance shall not be made by children without supervision.

### **Warning**

Children of less than 3 years should be kept away unless continuously supervised.

Children aged from 3 years and less than 8 years shall only switch on/off the appliance provided that it has been placed or installed in its intended normal operating position and they have been given supervision or instruction concerning use of the appliance in a safe way and understand the hazards involved.

Children aged from 3 years and less than 8 years shall not plug in, regulate and clean the appliance or perform user maintenance.

### **Warning**

Do not use the device in small rooms if persons are present who cannot leave the room independently and who are not under constant supervision.

### **Warning**

Sensors with temperature detection, or temperature controller, should not be placed within the radiation range of 130 degrees of the ceiling heating plate, otherwise it will affect the actual temperature detection .

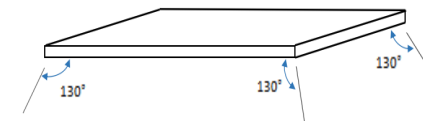

### **Warning**

Some parts of this product can become very hot and cause burns. Particular attention has to be given where children and vulnerable people are present. Its dangerous of installation close to curtains and other combustible materials. To avoid the possibility of burns, the following people should be much more careful when using the heaters: infants and kids, people with sensitive skin, the old, the sick, people who is drunk, people who takes sleeping pills.

- Remove the protective film(on the front) before using.
- Be sure the usage voltage is between 220-240V, 50Hz, and power supply has been strictly in accordance with IEC, left is null wire and right is live wire, and also well grounded.
- The devices will draw more current than small appliances, so a separate 5A socket is required.
- Do not use the device in potentially explosive rooms.
- Do not use the device in aggressive atmosphere.
- Set the device up in an upright and stable position.
- Let the device dry out after a wet clean. Do not operate it when wet.
- Do not use the device with wet or damp hands.
- Do not expose the device to directly squirting water.
- Never insert any objects or limbs into the device.

- Do not cover or transport the device during operation.
- Do not sit on the device.
- This appliance is not a toy! Keep away from children and animals. Do not leave the device unattended during operation.
- Check accessories and connection parts for possible damage prior to every use of the device. Do not use any defective devices or device parts.
- Ensure that all electric cables outside of the device are protected from damage (e.g. caused by animals). Never use the device if electric cables or the power connection are damaged!
- The electrical connection must correspond to the specifications in chapter Technical data.
- Do not use the device when the socket or wire overloaded.
- Observe the device's power input, cable length and intended use when selecting extensions to the power cable. Completely unroll extension cables. Avoid electrical overload.
- Before carrying out maintenance, care or repair work on the device, remove the mains plug from the mains socket or disconnect the circuit.
- Switch the device off and disconnect the power cable from the main socket when the device is not in use.
- Do not use the device under any circumstances if any damages on the mains plug or power cable. If the supply cord is damaged, it must be replaced by the manufacturer, its service agent or similarly qualified persons in order to avoid a hazard. Defective power cables pose a serious health risk.
- During the installation of the device observe the minimum distances from walls and other objects as well as the storage and operating conditions specified in the Technical data chapter.
- Never drill into the heating device.
- Do not use the device in immediate proximity to curtains.
- Do not place the device on combustible ground.
- Do not transport the device during operation.
- Do not touch the surface during the device working to avoid burns.
- Allow the device to cool down before transport and / or maintenance work.
- Do not use this device near bathtubs, shower trays, swimming pools or other water containers. Risk of electric shock!

- The device must be placed where the switches and controllers cannot be touched by a person in a bathtub or shower.
- Do not use this device in a child-care centre and bathroom.(Only for Sweden)

## 2 | FEATURES

- The device is designed to provide an efficient, comfortable and healthy heating system for any domestic users.
- These devices can reduce air circulation and help to maintain a clean, silent, dust free environment.
- A wide range of devices available in a huge choice of colors, sizes and styles.

## 3 | TECHNICAL INFORMATION

**LED Light HH series**

Heating element	Carbon
Heating way	Far infrared heating
Input Voltage	220-240V/50Hz
Surface temperature	Main 130-150°C
Frame	Aluminum
Over heating protection	Yes
Power cord length	≤1.9m

Model NO.	Size(mm)	Heating Power	LED Power	Voltage Frequency	Rated Current
HH0606L	655*630*35	370W	30W	230V/50Hz	1.7A
HH1006L	1080*630*35	660W	40W		3A
HH1206L	1280*630*35	800W	40W		3.6A

## 4 | SCOPE OF SUPPLY

- (A) 1 x heating device
- (B) 4 x Screws
- (C) 4 x Dowels
- (D) 2 x hanging units
- 1 x thermostat
- 1 x Manual

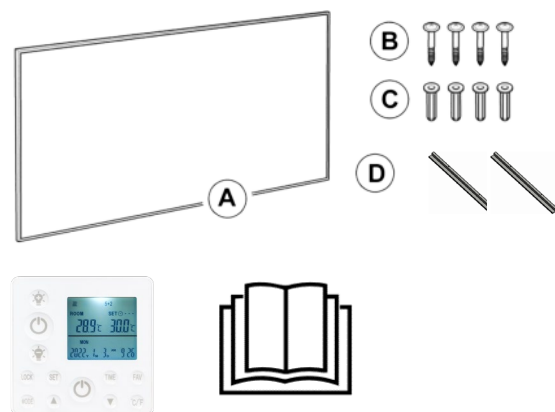

## 5 | DEVICE STRUCTURE

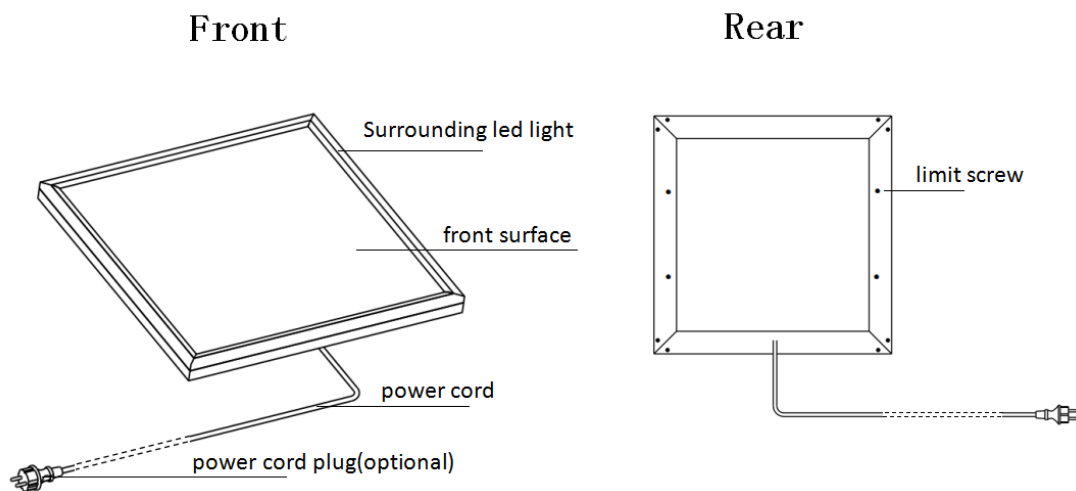

## 6 | INSTALLATION



### Warning

- Mounting work must be carried out by professional electrician !
- Do not suspend panels by heating power cord !
- No any sticking ways are allowed to be used for hanging or suspending support !
- Make sure the ceiling is stable enough !
- Do remove the front protective film before using !
- Power cord must be well grounded!

1. Drill four holes on the ceiling with correct distance A and distance B.



Must use CORRECT diameter drilling bit to avoid panel falling!

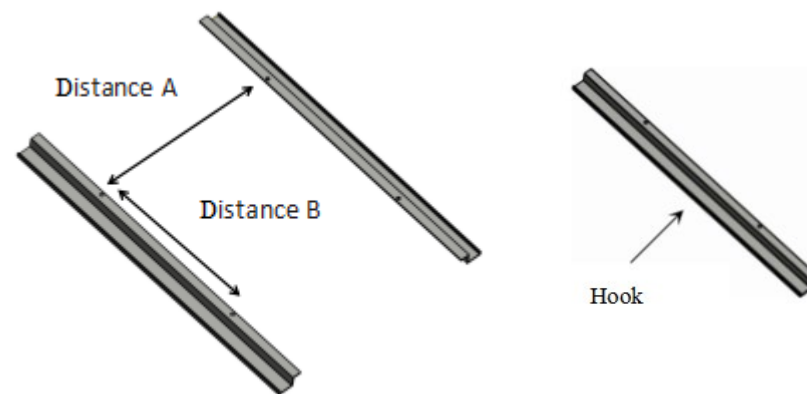

Panel Size/mm	Hole Distances of Screws/mm
655*630 (or similar)	A495*B100mm
1080*630(or similar)	A495*B300mm
1280*630 (or similar)	A495*B300mm

2. Mount the two hanging units onto ceiling with screws, and turn the screws to the end tightly, this is very important.

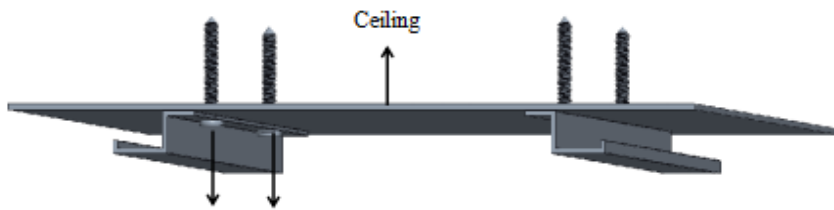

must be screwed to the end tightly

3. Push the rear of the left long frame into the hook, and then push back to make the rear of the right long frame into the other hook.

*Note: 1.Hooks are for the two long frames only, not the two short ones!*

*2.Make sure the hooks are between the two limit screws !*

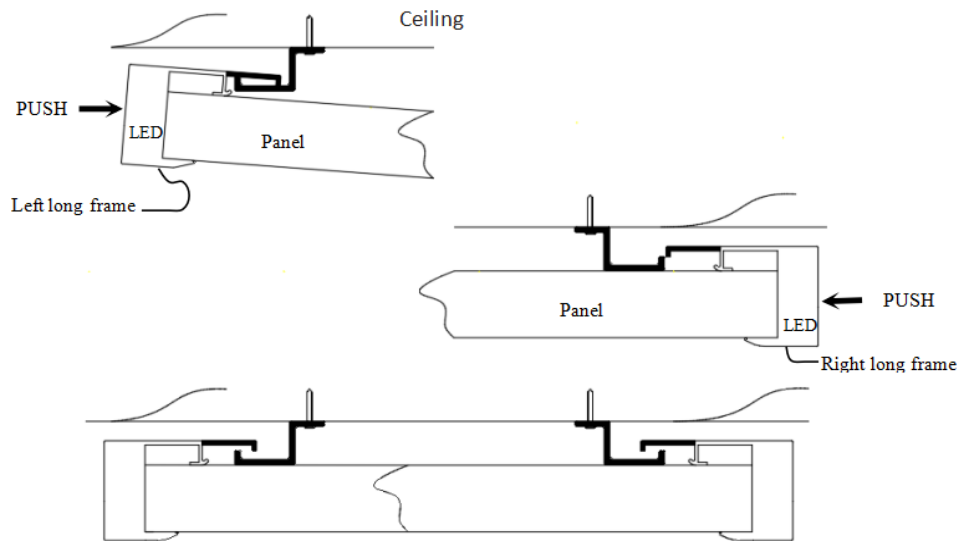

### WARNING

To avoid falling off, you must slide the panel left and right to make sure the two hooks have been completely put into the rear of the two long frames!

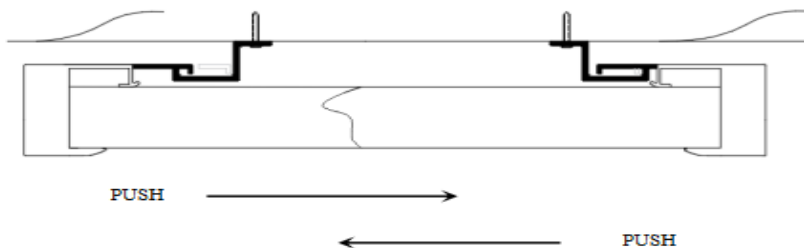

## 7 | THERMOSTAT

### Specification

- Battery-powered: DC 4x 1.5V AAA batteries (not included)
- Set temperature range: 0°C ~ 45°C, resolution: 1°C
- Room temperature range: 0°C ~ 50°C, display resolution: 0.1°C
- Accuracy of the measured temperature: ±0.5°C
- Working environment range 1°C ~ 50°C
- Radio frequency 433.92MHz

### Description

#### Operation Part for Light

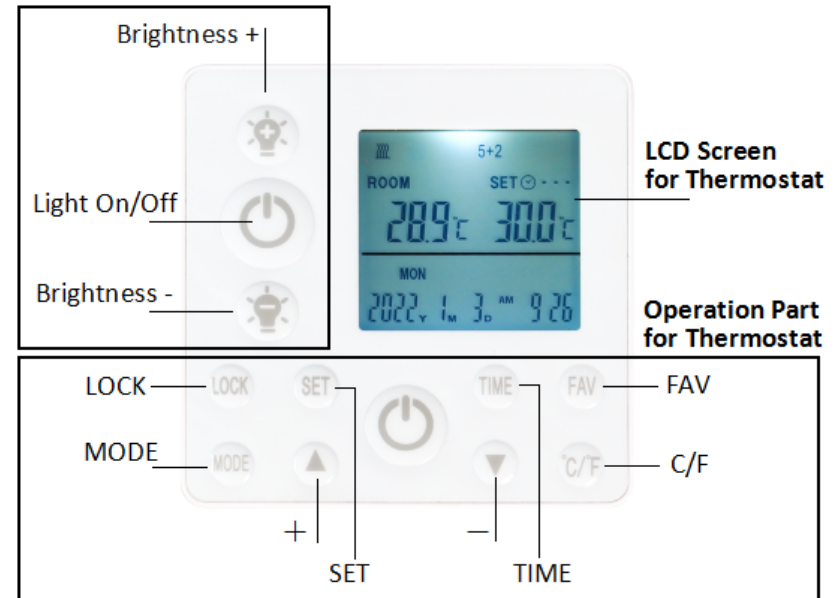

1. This thermostat also includes individual operation part for LED light.
2. The thermostat acquires the room temperature with its integrated sensor and transmit signal to the panel to turn on/off heating as the ambient temperature changing, in order to maintain a constant room temperature. When the ROOM temperature is 0.5°C higher than the SET temperature, thermostat will send OFF commands to panel; When the ROOM temperature is 0.5°C lower than the SET

temperature, thermostat will send ON commands to panel to turn on heating function.

3. The screen display shows the setting temperature as well as the measured temperature, time, date, modes etc.
4. The thermostat has week programmable、 temperature setting、 auto-off when temperature jump、 favorite temperature 、 time setting functions etc.
5. It is powered by 4pcs of 1.5V AAA batteries. Please change with new ones if the battery symbol gets flashing, or else it will not be able to control the panel.
6. Keypad locking function is designed to prevent the children from misusing.
7. LCD screen powered off means only the panel heating power off, the remote control itself is still under working state until batteries dead/out or broken.
8. The LCD screen only can work in temperature range from 1°C ~ 50°C.

## Operation Instructions of Heating Function

### Pair the thermostat with the heating device

Plug the panel into power socket, press ON/OFF for thermostat, then press button °C/°F and MODE buttons at same time to pair the thermostat with panel until a long beep sound heard.

*NOTE:*

- 1) Pairing should be finished within 1 minute, or else you need to re-power on the device.
- 2) Please re-power on the panel if you want to pair the device with another thermostat.
- 3) One thermostat can be paired to and work with several panels at same time.
- 4) Before pairing please do power off those panels which you don't want to pair.

### Set the Time and Day

It is essential that the clock time and day are set accurately if you require your programmed events to start on time.

**Step 1.** Press and hold TIME button for 3 seconds until the Year of date flashing.

**Step 2.** Use ▲ or ▼ button to set the Year, then short press TIME to save and proceed with setting up Month/Day/Hours/Minutes in similar manner.

**Step 3.** Short press TIME button again to save and exit.

### Manually turn the thermostat ON/OFF

Press ON/OFF button to turn the thermostat on/off.

When thermostat is turned Off, the LCD will only display current room temperature reading.

When thermostat is turned On, users can press ▲ or ▼ button to increase or decrease the set temperature. If the set temperature is below room temperature, heating device is now OFF. If the set temperature is above room temperature, the thermostat goes ON a  heating symbol appears on the screen of thermostat, it is now supplying power to heating device.

### Lock the buttons

Press and hold the LOCK button for 3 seconds until you see a lock icon  appearing. To unlock, repeat the steps above.

### °C/°F Display

Short press the C/F button to convert Celsius/Fahrenheit or Fahrenheit/Celsius.

### FAV Function

Press and hold FAV for 3 seconds until the set temperature icon flashes, press UP and DOWN to set a favorite temperature, short press FAV to confirm.

In daily use, set temperature will convert to favorite temperature when short press FAV button, and it will convert again to week target temperature at the time when TIMER ON start to work.

### 5+2 or 1...7 Programming Mode

Press the MODE and TIME buttons simultaneously to select 5+2 or 1...7 programming modes.

### Turns programming mode ON/OFF

Press and hold the MODE buttons for 3 seconds until you see ON appearing. To turn OFF, repeat the steps above.

### How to Programme Your Thermostat?

Press and hold the SET button for 3-5 seconds to enter into programming mode.

*Note: Programming mode has a time-out limit whereby if no buttons are pressed within 3-5seconds, it reverts back to the main screen.*

#### 1) 5+2 Programming Mode

You can program the thermostat to fit your lifestyle — week and weekend, plus up to 4 groups of time interval per day.

**Step 1.** Once in 5+2 mode, Press and hold the SET button for 3-5 seconds until Program icon ① and MON TUE WED THU FRI is displayed with ON and Time Icon flashing on screen.

**Step 2.** Press ▲ button to adjust hour(+1hour/press) and press ▼ to adjust Minute(+5minutes/press) to set the starting time of Program ①.

**Step 3.** Press the SET button once and OFF icon flashing on screen, Use ▲ Button to adjust hour (+1hour/press) and press ▼ to adjust minute (+5minutes/press) to set the ending time of Program ①.

**Step 4.** Press the SET button once again and set temperature icon flashing on screen, Use ▲ or ▼ button to set the desired temperature to be maintained for program ①.

**Step 5.** Press the SET button to bring up Program ② of week days , repeat Step 2-5. And users can set up Program ③ and ④ in similar manner.

**Step 6.** After finishing setting Program ④, press the SET button to bring up SAT and SUN setting, repeat step 2-5 to set Program ① ② ③ ④ of weekends.

## 2) 1-7 Programming Mode

You can program the thermostat everyday with setting 2 groups of time interval per day.

Once in 1-7 Mode, Press and hold the SET button for 3-5 seconds until Program icon ① and MON is displayed with ON and Time icon flashing on screen, users can follow the above step 2-4 to set On/Off time and desired temperature of Program ① and ② from Monday to Sunday in sequence.

*Tips:*

1). The default starting time is 00:00, the ending time is 00:00, and the default operating temperature is 15 degrees.

2). If the user does not adjust the default On/Off time of 00:00, the programming settings is invalid.

3). Running time of Program ① ② ③ ④ should not be overlapped, and the ending time value of each program must be later than the starting time, otherwise setting is invalid.

4). In 5+2 mode, if you do not want to set a mid-day heating period(Program ② or ③ ), simply set the programs ② or ③ to a lower temperature than default with very short intervals. An example is shown below.

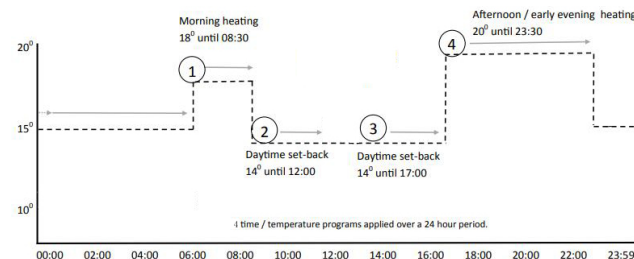

5). The programmed time / temperature setting will be restored with the next program entry in the memory.

6). Once finish setting up the programming mode, the thermostat will work under programming mode ON even if the thermostat is turned off. The heating device will be switched ON or OFF according to the programming setting.

## Open Window Detection

The thermostat will automatically turn off the heating device if a sudden drop in temperature in the room is detected.

## Operation Instructions of LED Lighting Function

- Once thermostat is paired with device, Press ON/OFF button for LED light to turn on/off the led light surrounding the panel, and long press ON/OFF button to switch light color (Cold Light—Warm Light—Nature Light if available).
- Press +/- to adjust the brightness, short press can adjust brightness to 100%, 75%, 50% and 25%, long press can adjust from 100% to 5%.

## Notes

- All settings need to be re-set after battery replacement.
- Alkaline battery is recommended. If ALL buttons on the thermostat are not working, try replacing the batteries.
- Please do change the batteries with new ones once the screen battery symbol gets flashing, or else it may result in halted/stuck/not working.
- Check if set temperature is higher enough than room temperature first if the heating can not be turned on by thermostat.



- 5 Make sure the Programming function has been switched to ON by long press MODE setting if you want to use any programming mode.
- 6 Do not cover or touch the temperature sensor which is at the top of the thermostat.
- 7 Do not put the thermostat in a open normal room environment rather not inside a drawer/pocket or under pillow/quilt etc.

Please do not take out the batteries from the thermostat if long time no use.

## 8 | TROUBLESHOOTING

Problem	Reason	Measure
It has noise when original charged with electricity	Due to the structure stress of the heat insulator.	It is a normal phenomenon. Don't worry about it.
The surface of the device was slightly raised.	Due to the thermal expansion of the surface material.	It is a normal phenomenon. Don't worry about it.
The surface of the heating device is slightly warm.	1. The voltage is low. 2. In a low-temperature environment.	1. Install a voltage regulator. 2. It is normal.

## 9 | MAINTENANCE & SERVICING

### Activities required before starting maintenance



#### Warning of electrical voltage

- If the power cord comes without plug, disconnect the circuit before connecting it.
- Do not touch the mains plug or power cord connection with wet or damp hands.
- Hold onto the mains plug while pulling the power cable out of the mains socket.
- Allow the device to cool down completely.



#### Warning of electrical voltage

Tasks which require the housing to be opened must only be carried out by authorized specialist companies.

#### Cleaning the device



#### Warning of electrical voltage

Never immerse the device in water!

Clean the device with a soft, damp and lint-free cloth.

Ensure that no moisture enters the housing. Protect electrical components from moisture. Do not use any aggressive cleaning agents such as cleaning sprays, solvents, alcohol-based or abrasive cleaners to dampen the cloth.

Wipe the housing dry after cleaning

## 10 | STORAGE

When the device is not being used, observe the following storage conditions:

- dry and protected from frost and heat
- in an upright position where it is protected from dust and direct sunlight
- with a cover to protect it from invasive dust, if necessary
- Place no further devices or objects on top of the device to prevent it from being damaged.

## 11 | TECHNICAL ANNEX

Information requirements for electrical local space heaters

Item	Unit
<b>Type of heat input, for electric storage local space heaters only (select one)</b>	
manual heat charge control, with integrated thermostat	N/A
manual heat charge control with room and/or outdoor	N/A
electronic heat charge control with room and/or outdoor	N/A
fan assisted heat output	N/A
<b>Type of heat output/room temperature control (select one)</b>	
single stage heat output and no room temperature control	[no]
Two or more manual stages, no room temperature control	[no]
with mechanic thermostat room temperature control	[no]
with electronic room temperature control	[no]
electronic room temperature control plus day timer	[no]
electronic room temperature control plus week timer	[yes]
<b>Other control options (multiple selections possible)</b>	
room temperature control, with presence detection	[no]
room temperature control, with open window detection	[no]
with distance control option	[no]
with adaptive start control	[yes]
with working time limitation	[no]
with black bulb sensor	[no]

## 12 | DISPOSAL



The icon with the crossed-out waste bin on waste electrical or electronic equipment stipulates that this equipment must not be disposed of with the household waste at the end of its life. You will find collection points for free return of waste electrical and electronic equipment in your vicinity. The addresses can be obtained from your municipality or local administration.

The separate collection of waste electrical and electronic equipment aims to enable the re-use, recycling and other forms of recovery of waste equipment as well as to prevent negative effects for the environment and human health caused by the disposal of hazardous substances potentially contained in the equipment.