

NINJA®

OP500UK Series

INSTRUCTIONS

FOODI® MAX TENDERCRISP™ PRESSURE COOKER



THANK YOU

for purchasing the Ninja® Foodi® Max TenderCrisp™ Pressure Cooker



REGISTER YOUR PURCHASE

 ninjakitchen.eu

 Scan QR code using mobile device

RECORD THIS INFORMATION

Model Number: _____

Serial Number: _____

Date of Purchase: _____
(Keep receipt)

Store of Purchase: _____

TECHNICAL SPECIFICATIONS

Voltage: 230V~, 50Hz

Watts: 1760W

Volume: 7.5L

Fluid Group: 2

TIP: You can find the model and serial numbers on the QR code label located on the back of the unit by the power cord.

CONTENTS

Important Safeguards	2
Parts & Accessories	6
Using the Control Panel	8
Function Buttons.....	8
Operating Buttons.....	8
Before First Use	9
Installing the Condensation Collector.....	9
Removing & Reinstalling the Anti-Clog Cap.....	9
Using Your Foodi® Max TenderCrisp™ Pressure Cooker	10
Swap the Top.....	10
Using the Crisping Lid.....	10
Using the Cooking Functions with the Crisping Lid.....	10
Air Crisp.....	10
Grill.....	11
Bake/Roast.....	12
Dehydrate.....	13
Installing & Removing the Pressure Lid.....	14
Water Test: Get Started Pressure Cooking.....	14
Natural Pressure Release vs. Quick Pressure Release.....	15
Pressurising.....	15
Using the Cooking Functions with the Pressure Lid.....	16
Pressure Cook.....	16
Steam.....	17
Slow Cook.....	18
Yogurt.....	18
Sear/Sauté.....	19
Accessories for Purchase	20
Cleaning & Maintenance	21
Cleaning: Dishwasher & Hand-Washing.....	21
Removing & Reinstalling the Silicone Ring.....	21
Troubleshooting Guide	22
Helpful Tips	24
Replacement Parts	25
Product Registration	25

IMPORTANT SAFEGUARDS

HOUSEHOLD USE ONLY • READ ALL INSTRUCTIONS BEFORE USE

Read all instructions before using your Ninja® Foodi® Max TenderCrisp™ Pressure Cooker.

When using electrical appliances, basic safety precautions should always be followed, including the following:

⚠ WARNING

- 1 This appliance can be used by persons with reduced physical, sensory or mental capabilities or lack of experience and knowledge if they have been given supervision or instruction concerning use of the appliance in a safe way and understand the hazards involved.
- 2 Keep the appliance and its cord out of reach of children. **DO NOT** allow the appliance to be used by children. Close supervision is necessary when used near children.
- 3 **DO NOT** use an extension cord. A short power-supply cord is used to reduce the risk of children grabbing the cord or becoming entangled and to reduce the risk of people tripping over a longer cord.
- 4 Children shall not play with the appliance.
- 5 **NEVER** use socket below counter.
- 6 **NEVER** connect this appliance to an external timer switch or separate remote-control system.
- 7 **DO NOT** use an extension cord. A short power-supply cord is used to reduce the risk of children grabbing the cord or becoming entangled and to reduce the risk of people tripping over a longer cord.
- 8 To protect against electrical shock **DO NOT** immerse cord, plugs, or main unit housing in water or other liquid. Cook only in the pot provided or in a container recommended by SharkNinja placed in the provided pot.
- 9 Regularly inspect the appliance and power cord. **DO NOT** use the appliance if there is damage to the power cord or plug. If the appliance malfunctions or has been damaged in any way, immediately stop use and call Customer Service.
- 10 **ALWAYS** ensure the appliance is properly assembled before use.
- 11 Before use, **ALWAYS** check pressure release valve and red float valve for clogging or obstruction, and clean them if necessary. Check to make sure the red float valve on the pressure lid moves freely. Foods such as apple sauce, cranberries, pearl barley, oatmeal or other cereals, split peas, noodles, macaroni, rhubarb, or spaghetti can foam, froth, and splutter when pressure cooked, clogging the pressure release valve. These and similar expanding foods (such as dried vegetables, beans, grains, and rice) should not be cooked in a pressure cooker, except when following a Ninja® Foodi® recipe.
- 12 **DO NOT** cover the air intake vent or air socket vent while crisping lid is closed. Doing so will prevent even cooking and may damage the unit or cause it to overheat.
- 13 To prevent risk of explosion and injury, use only SharkNinja Silicone rings. Make certain silicone ring is installed and lid is properly closed before operating. **DO NOT** use if torn or damaged. Replace before using.

- 14 Before placing removable cooking pot into the cooker base, ensure pot and cooker base are clean and dry by wiping with a soft cloth.
- 15 This appliance is for household use only. **DO NOT** use this appliance for anything other than its intended use. **DO NOT** use in moving vehicles or boats. **DO NOT** use outdoors. Misuse may cause injury.
- 16 Intended for worktop use only. Ensure the surface is level, clean and dry. **DO NOT** move the appliance when in use.
- 17 **DO NOT** place appliance on hot surfaces or near a hot gas or electric burner or in a heated oven.
- 18 **DO NOT** use accessory attachments not recommended or sold by SharkNinja. **DO NOT** place accessories in a microwave, toaster oven, convection oven, or conventional oven or on a ceramic cooktop, electric coil, gas burner range, or outdoor grill. The use of accessory attachments not recommended by SharkNinja may cause fire, electric shock, or injuries.
- 19 When using this appliance, provide adequate space above and on all sides for air circulation.
- 20 **ALWAYS** follow the maximum and minimum quantities of liquid as stated in instructions and recipes.
- 21 **NEVER** use SLOW COOK setting without food and liquids in the removable cooking pot.
- 22 **DO NOT** use the appliance without the removable cooking pot installed.
- 23 **DO NOT** use this appliance for deep frying.
- 24 **DO NOT** cover the pressure valves.
- 25 **DO NOT** sauté or fry with oil while pressure cooking.
- 26 Prevent food contact with heating elements. **DO NOT** overfill or exceed the MAX fill level when cooking. Overfilling may cause personal injury or property damage or affect the safe use of the appliance.
- 27 When pressure cooking foods that expand (such as dried vegetables, beans, grains, rice, etc.). **DO NOT** fill pot more than halfway, or as otherwise instructed in a Ninja® Foodi® recipe.
- 28 **DO NOT** use this unit to cook instant rice.
- 29 To prevent food contact with the heating elements, **DO NOT** overfill the Cook & Crisp™ Basket.
- 30 Use extreme caution when closing the crisping lid, taking care that nothing is caught in or pinched by the hinge.
- 31 Socket voltages can vary, affecting the performance of your product. To prevent possible illness, use a thermometer to check that your food is cooked to the temperatures recommended.
- 32 **DO NOT** place the appliance near the edge of a worktop during operation.
- 33 To avoid possible steam damage, place the unit away from walls and cabinets during use.
- 34 Should the unit emit black smoke, unplug immediately and wait for smoking to stop before removing the cooking pot and Cook & Crisp™ Basket.

SAVE THESE INSTRUCTIONS

IMPORTANT SAFEGUARDS

HOUSEHOLD USE ONLY • READ ALL INSTRUCTIONS BEFORE USE

- 35 DO NOT** touch hot surfaces. Appliance surfaces are hot during and after operation. To prevent burns or personal injury, **ALWAYS** use protective hot pads or insulated oven mitts and use available handles and knobs.
- 36** Extreme caution must be used when the cooker contains hot oil, hot food, or hot liquids, or if the cooker is under pressure. Improper use, including moving the cooker, may result in personal injury. When using this appliance to pressure cook, ensure the lid is properly assembled and locked into position before use.
- 37** Caution should be used when searing meats and sautéing in hot oil. Keep hands and face away from the removable cooking pot, especially when adding new ingredients, as hot oil may splatter.
- 38** When unit is in operation, hot steam is released through the air socket vent. Place unit so vent is not directed toward the power cord, sockets, or other appliances. Keep your hands and face at a safe distance from vent.
- 39 DO NOT** attempt to open the lid during or after pressure cooking until all internal pressure has been released through the pressure release valve and the unit has cooled slightly. **DO NOT** tamper with, disassemble, or otherwise remove the red float valve or pressure release assembly.
- 40** When using SLOW COOK or SEAR/SAUTÉ settings, **ALWAYS** keep the pressure lid closed and the pressure release valve in the VENT position. If the lid is closed and the pressure release valve is in the SEAL position, an audible alarm will sound. "VENT" error code will appear on LED display to signal the need to turn the pressure release valve to the VENT position.
- 41** When using the PRESSURE COOK setting, **ALWAYS** keep the pressure lid locked and the pressure release valve turned anticlockwise to the SEAL position.
- 42** If the lid will not turn to unlock, this indicates the appliance is still under pressure. Any pressure remaining can be hazardous. Let unit naturally release pressure or turn the Pressure Release Valve slowly to the VENT position to release steam. Take care to avoid contact with the releasing steam to avoid burns or injury. When the steam is completely released, the red float valve will be in the lower position allowing the lid to be removed.
- 43** Spilled food can cause serious burns. Keep appliance and cord away from children. **DO NOT** let cord hang over edge of tables or counters or touch hot surfaces.
- 44 ALWAYS** keep hands, face, and other body parts away from the pressure release valve prior to or during pressure release and when removing the pressure lid after cooking. Serious burns can result from the steam inside. **ALWAYS** lift and tilt the lid away from you when removing.
- 45** When removable cooking pot is empty, **DO NOT** heat it for more than 10 minutes, as doing so may damage the cooking surface.
- 46** The cooking pot, Cook & Crisp™ Basket, and reversible rack become extremely hot during the cooking process. Avoid hot steam and air while removing the cooking pot and Cook & Crisp™ Basket from the appliance, and **ALWAYS** place them on a heat resistant surface after removing. **DO NOT** touch accessories during or immediately after cooking.
- 47** Removable cooking pot can be extremely heavy when full of ingredients. Care should be taken when lifting pot from cooker base.
- 48** Cleaning and user maintenance shall not be made by children.
- 49** Let the appliance cool for approximately 30 minutes before handling, cleaning, or storing.
- 50** To disconnect, turn any control to "off", then unplug from socket when not in use and before cleaning. Allow to cool before cleaning, disassembly, putting in or taking off parts and for storage.
- 51 DO NOT** clean with metal scouring pads. Pieces can break off the pad and touch electrical parts, creating a risk of electric shock.
- 52** Please refer to the Cleaning & Maintenance section for regular maintenance of the appliance.



Indicates to read and review instructions to understand operation and use of product.



Indicates the presence of a hazard that can cause personal injury, death or substantial property damage if the warning included with this symbol is ignored.



Take care to avoid contact with hot surface. Always use hand protection to avoid burns.



For indoor and household use only.

SAVE THESE INSTRUCTIONS

PARTS & ACCESSORIES

PARTS

- A** Top Tier (Lower rack)
- B** Reversible Rack
- C** Cook & Crisp™ Basket
- D** Detachable Diffuser
- E** 7.5L Removable Cooking Pot
- F** Crisping Lid
- G** Heat Shield
- H** Control Panel
- I** Cooker Base
- J** Pressure Lid
- K** Pressure Release Valve
- L** Float Valve
- M** Silicone Ring
- N** Anti-Clog Cap
- O** Air Outlet Vent
- P** Condensation Collector

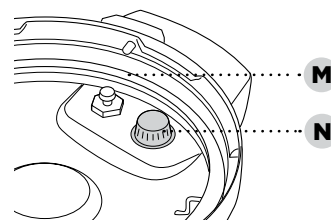
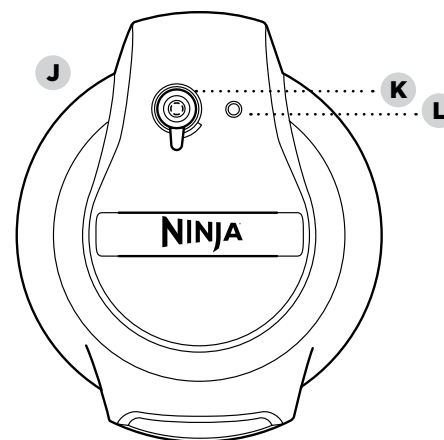
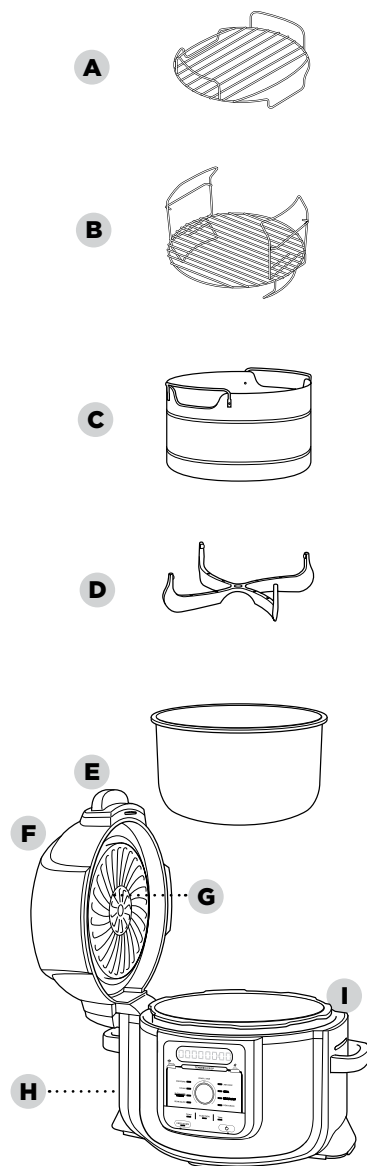

Underside of Pressure Lid

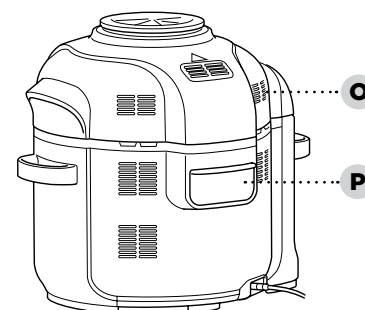

ACCESSORY ASSEMBLY INSTRUCTIONS

2 TIER REVERSIBLE RACK

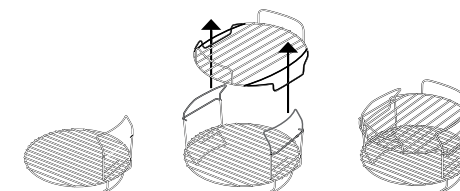

- 1** Place the reversible rack in the pot in the lower position.
- 2** Drop the lower rack through the reversible rack handles.

COOK & CRISP™ BASKET

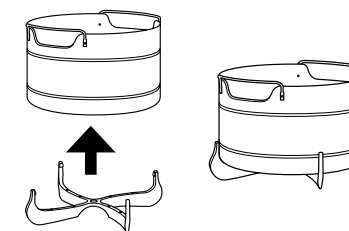

- 1** To remove diffuser for cleaning, pull 2 diffuser fins off the groove on the basket, then pull down firmly.
- 2** To assemble the Cook & Crisp Basket, place basket on top of diffuser and press down firmly.

USING THE CONTROL PANEL

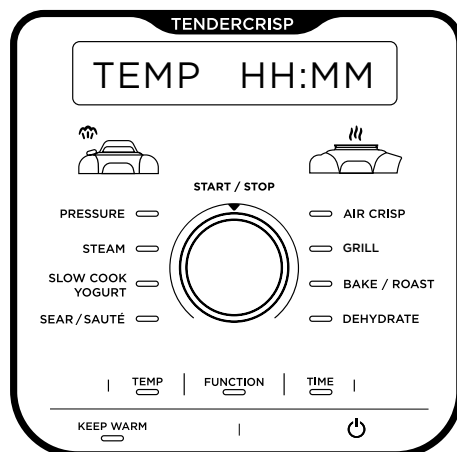

NOTE: Control panel may differ per model.

COOKING FUNCTIONS

PRESSURE: Use to cook food quickly while maintaining tenderness.

STEAM: Use to gently cook delicate foods at a high temperature.

SLOW COOK: Cook your food at a lower temperature for longer periods of time.

YOGURT: Pasteurise and ferment milk for creamy homemade yogurt.

SEAR/SAUTÉ: To use the unit as a stovetop for browning meats, sautéing vegetables, simmering sauces and more.

AIR CRISP: Give foods crispiness and crunch with little to no oil.

BAKE/ROAST: Use the unit like an oven for tender meats, baked treats and more.

GRILL: Use high temperature to caramelize and brown your food.

DEHYDRATE: Dehydrate meats, fruits and vegetables for healthy snacks.

NOTE: If running for 1 hour or less, the clock will count down by minutes and seconds. If running for more than 1 hour, the clock will count down by minutes only.

OPERATING BUTTONS

FUNCTION: Press FUNCTION, then use the START/STOP dial to choose a cooking function.

TEMP: Press TEMP, then use the START/STOP dial to adjust the cooking temperature and/or pressure level.

TIME: Press TIME, then use the START/STOP dial to adjust the cook time.

NOTE: To adjust settings while cooking, press TEMP or TIME, then turn the START/STOP dial to choose desired temperature or time.

START/STOP dial/button: Use the dial to choose a cooking function, cook temperature and cook time. Press the button to start cooking. Pressing the button while the unit is cooking will stop the current cooking function.

KEEP WARM: After pressure cooking, steaming, or slow cooking, the unit will automatically switch to Keep Warm mode and start counting up. Keep Warm will stay on for 12 hours, or you may press KEEP WARM to turn it off. Keep Warm mode is not intended to warm food from a cold state but to keep it warm at a food-safe temperature.

POWER: The Power button shuts the unit off and stops all cooking modes.

BEFORE FIRST USE

- 1 Remove and discard any packaging material, promotional labels, and tape from the unit.
- 2 Please pay particular attention to operational instructions, warnings, and important safeguards to avoid any injury or property damage.
- 3 Wash the pressure lid, silicone ring, removable cooking pot, Cook & Crisp™ Basket, reversible rack, and condensation collector in hot, soapy water, then rinse and dry thoroughly. **NEVER** clean the cooker base or pressure lid in the dishwasher. Inspect the pressure lid to ensure there is no debris blocking the valves.
- 4 The silicone ring is reversible and can be inserted in either direction. Insert the silicone ring around the outer edge of the silicone ring rack on the underside of the lid. Ensure it is fully inserted and lies flat under the silicone ring rack.

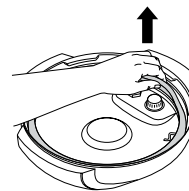

INSTALLING THE CONDENSATION COLLECTOR

To install the condensation collector, slide it into the slot on the cooker base. Slide it out to remove it for hand-washing after each use.

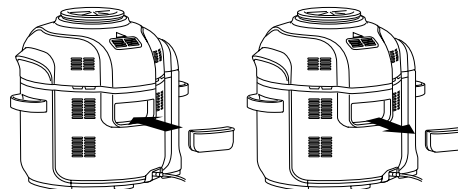

REMOVING & REINSTALLING THE ANTI-CLOG CAP

Make sure your anti-clog cap is in the correct position before using the pressure lid. The anti-clog cap protects the inner valve of the pressure lid from clogging and protects users from potential food splatters. It should be cleaned after every use with a cleaning brush. To remove it, squeeze and pull upward. To reinstall, position it in place and press down.

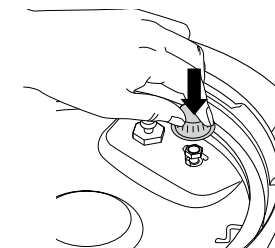
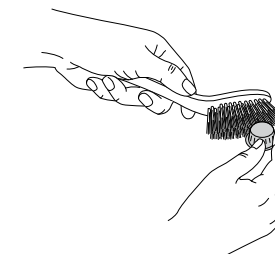
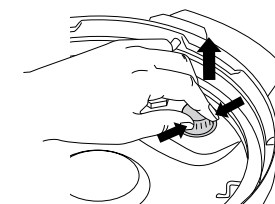

NOTE: Prior to each use, make sure the silicone ring is well seated in the silicone ring rack and the anti-clog cap is mounted properly on the pressure release valve.

USING YOUR FOODI® MAX TENDERCRISP™ PRESSURE COOKER

SWAP THE TOP

The two lids allow you to seamlessly transition between all your favourite cooking methods. Use the pressure lid to tenderise, then use the crisping lid to crisp up your food.

USING THE CRISPING LID

The crisping lid is attached to the unit and can be opened at any time to check on your food during the cooking process. When the lid is opened, the timer will pause, and the heating element will turn off. When the lid is closed, cooking will begin again and the timer will resume counting down.

USING THE COOKING FUNCTIONS WITH THE CRISPING LID

To turn on the unit, plug the power cord into a wall socket, then press the .

Air Crisp

- 1 Place either the Cook & Crisp™ Basket or reversible rack in the pot. Basket should have diffuser attached.

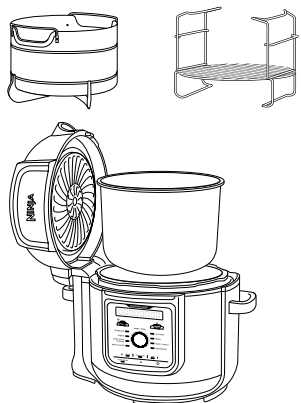

- 2 Add ingredients to the Cook & Crisp Basket or reversible rack. Close the lid.

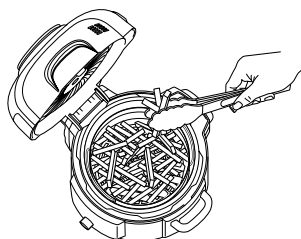

- 3 Press FUNCTION, then turn the START/STOP dial to select AIR CRISP. The default temperature setting will display. Press TEMP, then turn the dial to choose a temperature between 150°C and 200°C.

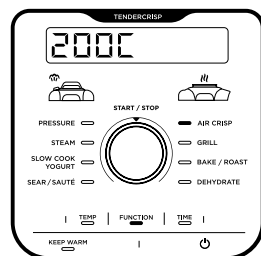

- 4 Press TIME, then turn the START/STOP dial to adjust the cook time in minute increments up to 1 hour. To preheat your unit, simply add an additional 5 minutes to the cook time. Press START/STOP to begin cooking.

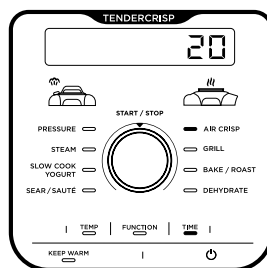

- 5 During cooking, you can open the lid and lift out the basket to shake or toss ingredients for even browning, if needed. When done, lower basket back into pot and close lid. Cooking will automatically resume after lid is closed.

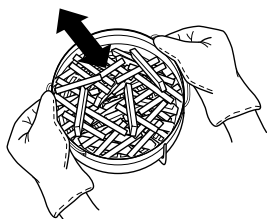

- 6 When cook time is complete, the unit will beep and display DONE.

Grill

- 1 Place the reversible rack in the pot in the higher grill position or follow the directions in your recipe.

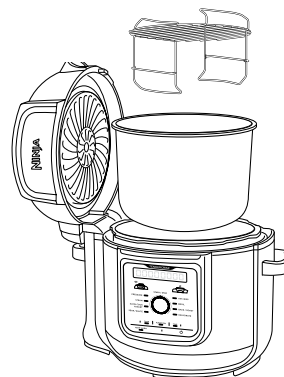

- 2 Place ingredients on the rack, then close the lid.

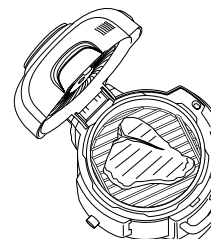

- 3 Press FUNCTION, then turn the START/STOP dial to select GRILL.

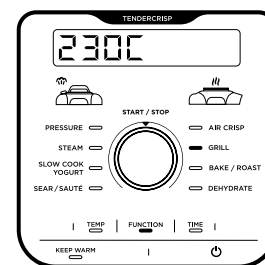

NOTE: There is no temperature adjustment available or necessary when using the Grill function.

- 4 Press TIME, then turn the dial to adjust the cook time in minute increments up to 30 minutes.

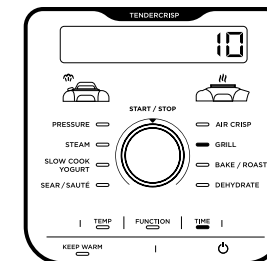

- 5 Press START/STOP to begin cooking.
- 6 When cook time is complete, the unit will beep and display DONE.

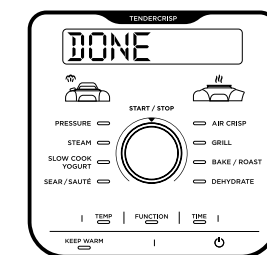

USING YOUR FOODI® MAX TENDERCRISP™ PRESSURE COOKER – CONT.

Bake/Roast

- 1 Add ingredients and any accessories to the pot. Close the lid.
- 2 Press FUNCTION, then turn the START/STOP dial to select BAKE/ROAST. The default temperature setting will display. Press TEMP, then turn the dial to select a temperature between 120°C and 200°C.

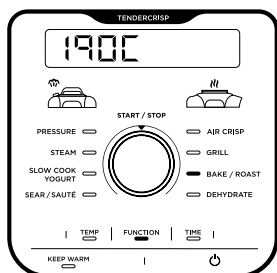

- 3 Press TIME, then turn the START/STOP dial to adjust the cook time in minute increments up to 1 hour and then 5-minute increments from 1 hour to 4 hours. Press START/STOP to begin cooking.

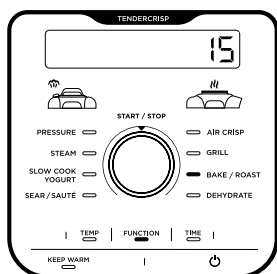

- 4 When cook time is complete, the unit will beep and display DONE.

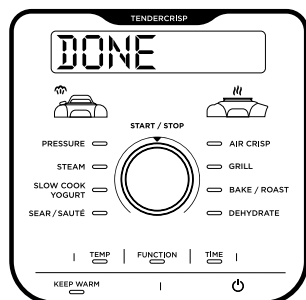

Dehydrate

- 1 Place the 2 tier reversible rack in the pot, then place a layer of ingredients on the rack.

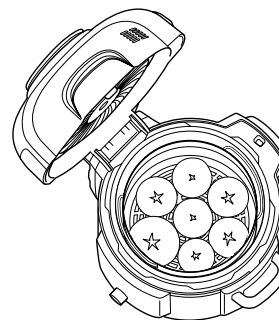

- 2 Holding the top tier by its handles, place it down over the reversible rack in the position shown below. Then place a layer of ingredients on the top tier and close the lid.

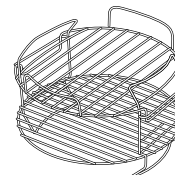

NOTE: For five levels of capacity, use the Dehydrator Stand (sold separately) directly in the cooking pot.

- 3 Press FUNCTION, then turn the START/STOP dial to select DEHYDRATE. The default temperature setting will display. Press TEMP, then turn the dial to choose a temperature between 25°C and 90°C.

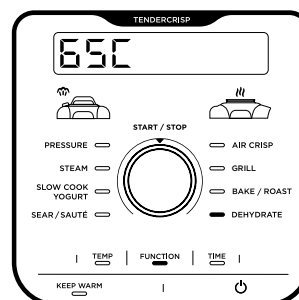

- 4 Press TIME, then turn the dial to adjust the cook time in 15-minute increments up to 12 hours.

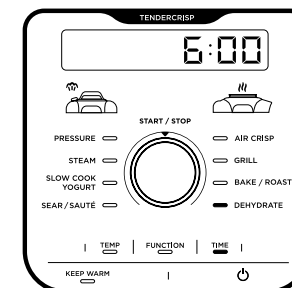

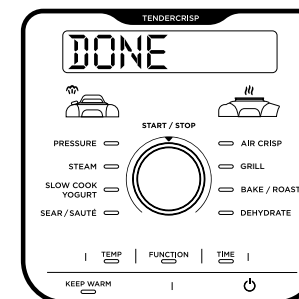

- 5 Close the lid and press START/STOP to begin dehydrating.
- 6 When cook time is complete, the unit will beep and display DONE.



USING YOUR FOODI® MAX TENDERCRISP™ PRESSURE COOKER – CONT.

INSTALLING & REMOVING THE PRESSURE LID

- Place the pressure lid on top of the unit with the  on the lid and the  on the base lined up evenly. Turn the lid clockwise until it locks in place.

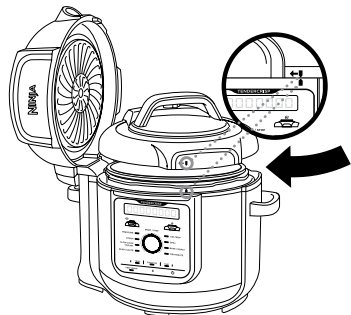

- Pressure Lid is locked when it has clicked into place and the Ninja Logo is facing you.

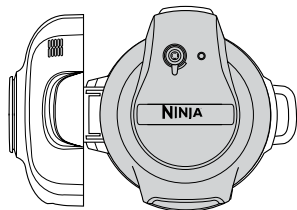

- To unlock the pressure lid, turn it counterclockwise. Lift it up and away from you, as some steam will remain in the unit and escape when the lid is opened.

NOTE: The pressure lid will not unlock until the unit is completely depressurised.



SEAL
for Pressure Cook



VENT
for Steam, Slow Cook,
and Sear/Sauté

NOTE: Valve will be loose when fully installed.

WATER TEST: GETTING STARTED PRESSURE COOKING

It is recommended that first-time users do the water test to familiarise themselves with Pressure Cooking.

- Place the pot in the cooker base and add 750ml of room-temperature water to the pot.

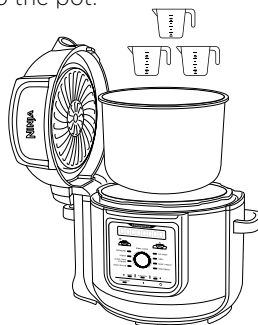

- Assemble the pressure lid by aligning the arrow on the front of the lid with the arrow on the front of the cooker base. Then turn the lid clockwise until it locks in place.

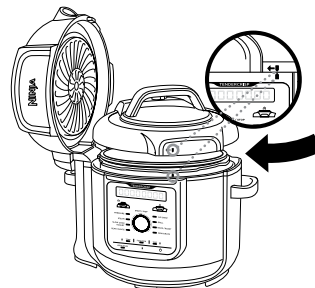

- Make sure the pressure release valve is in the SEAL position.



- Press FUNCTION, then turn the START/STOP dial to select PRESSURE. The unit will default to high (HI) pressure and a time setting of 2 minutes. Press START/STOP to begin.

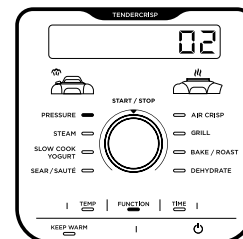

- The display showing PRE and some steam release indicate pressure is building. When fully-pressurised, countdown will begin.



NOTE: Time to pressure varies and may take up to 15 minutes.

- When the countdown is finished, the unit will beep and display DONE before automatically switching to KEEP WARM mode, and begin counting up.

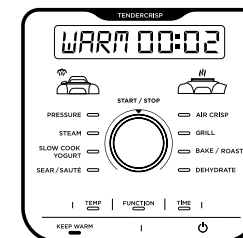

- Turn the pressure release valve to the VENT position to quick release the pressurised steam. There will be a burst of steam from the pressure release valve. When steam is completely released, float valve will drop and the lid can be opened.



NATURAL PRESSURE RELEASE VS. QUICK PRESSURE RELEASE

Natural Pressure Release: When pressure cooking is complete, steam will naturally release from the unit as it cools down. This can take upwards of 20 minutes, depending on the amount of ingredients in the pot. During this time, the unit will switch to Keep Warm mode. Press KEEP WARM if you would like to turn Keep Warm mode off. When natural pressure release is complete, the float valve will drop down.

Quick Pressure Release: Use **ONLY** if your recipe calls for it. After pressure cooking and the KEEP WARM light comes on, turn the pressure release valve to the VENT position to quickly release the steam. Steam release will be accompanied by an audible hiss.

Some steam will remain in the unit after pressure release and will escape when the lid is opened. Lift and tilt it away from you, making sure no condensation drips into the cooker base.



NOTE: At any time during the natural release process, you can switch to quick release by turning the pressure release valve to the VENT position.

PRESSURISING

As pressure builds in the unit, the control panel will display PRE. Time to pressure varies based on the amount and temperature of ingredients as well as liquid in the pot. For safety, the lid will lock as the unit pressurizes, and it will not unlock until pressure is released. Once the unit has reached full pressure, the cooking cycle will begin and the timer will start counting down.



NOTE: It can take upwards of 20 minutes to build pressure.

USING YOUR FOODI® MAX TENDERCRISP™ PRESSURE COOKER – CONT.

USING THE COOKING FUNCTIONS WITH THE PRESSURE LID

To turn on the unit, plug the power cord into a wall outlet, then press the .

Pressure Cook

- 1 Place ingredients and at least 1 cup of liquid in the pot, as well as any necessary accessory. **DO NOT** fill the pot past the PRESSURE MAX line.

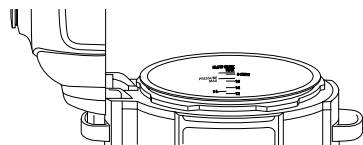

NOTE: When cooking rice, beans, or other ingredients that expand, **DO NOT** fill the pot more than halfway.

- 2 Install the pressure lid and turn the pressure release valve to the SEAL position.



- 3 Press FUNCTION, then turn the START/STOP dial to select PRESSURE. The default pressure level will display. Press TEMP, then turn the dial to select HI or LO.

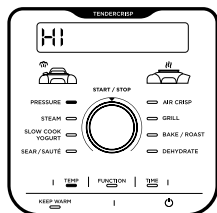

NOTE: If running for 1 hour or less, the clock will count down by minutes and seconds. If running for more than 1 hour, the clock will count down by minutes only.

- 4 Press TIME, then turn the dial to adjust the cook time in minute increments up to 1 hour, and then 5-minute increments from 1 hour to 4 hours.

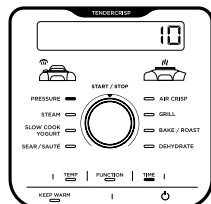

- 5 Press START/STOP to begin cooking. The unit will begin to build pressure, and PRE will be shown on the display. The unit will begin counting down when it is fully pressurized.



NOTE: Time to pressure varies and may take up to 15 minutes.

- 6 When cook time is complete, the unit will beep, automatically switch to Keep Warm mode, and begin counting up.



NOTE: After cooking is complete, you may press KEEP WARM to turn the Keep Warm mode off.

- 7 Let the unit naturally release pressure or, if the recipe instructs, turn the pressure release valve to the VENT position to quick release the steam.



Steam

- 1 Add 1 cup of liquid (or recipe-specified amount) to the pot, then place the reversible rack or Cook & Crisp™ Basket with ingredients in the pot.

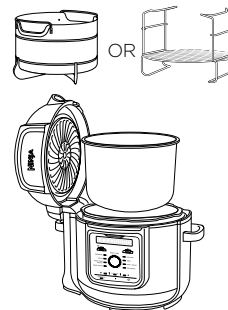

- 2 Install the pressure lid and turn the pressure release valve to the VENT position.



- 3 Press FUNCTION, then turn the START/STOP dial to select STEAM.

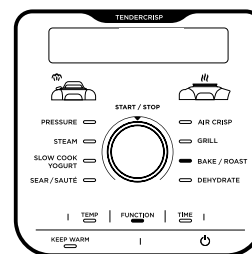

NOTE: There is no temperature adjustment when using the STEAM function.

- 4 Press TIME, then turn the dial to adjust the cook time in minute increments up to 30 minutes. Press START/STOP to begin cooking.

- 5 The unit will begin preheating to bring the liquid to a boil. The display will show PRE. The preheating animation will show until the unit reaches temperature and then the display will show BOIL and the timer will begin counting down.



- 6 When cook time is complete, the unit will beep and automatically switch to Keep Warm mode and begin counting up. Ensure the float valve has dropped before opening the lid.

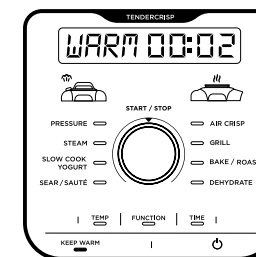

NOTE: After cooking is complete, you may press the KEEP WARM button to turn the Keep Warm mode off.

USING YOUR FOODI® MAX TENDERCRISP™ PRESSURE COOKER – CONT.

Slow Cook

- 1 Add ingredients to the pot. **DO NOT** fill the pot past the MAX line.
- 2 Install the pressure lid and turn the pressure release valve to the VENT position.



- 3 Press FUNCTION, then turn the START/STOP dial to select SLOW COOK. The default temperature setting will display. Press TEMP, then turn the dial to select HI or LO.

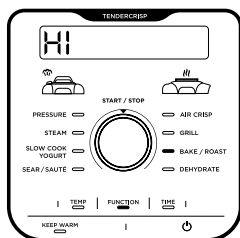

- 4 Press TIME, then turn the dial to adjust the cook time in 15-minute increments up to 12 hours.

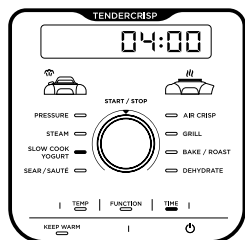

- 5 Press START/STOP to begin cooking.

NOTE: The Slow Cook HIGH time setting may be adjusted between 4 and 12 hours; the Slow Cook LOW time setting may be adjusted between 6 and 12 hours.

- 6 When cook time is complete, the unit will beep, automatically switch to Keep Warm mode, and begin counting up.

NOTE: After cooking is complete, you may press KEEP WARM to turn the Keep Warm mode off.

Yogurt

- 1 Add desired amount of milk to the pot.

NOTE: If you prefer to pasteurise, cool, and add cultures not using the unit, skip steps 1-9. Instead press TEMP, select FMNT, press TIME, select desired incubation time, then press START/STOP to begin.

- 2 Install the pressure lid and turn the pressure release valve to the VENT position.



- 3 Press FUNCTION, then turn the START/STOP dial to select YOGURT. The default temperature setting will display. Press TEMP, then turn the dial to select YGRT or FMNT.

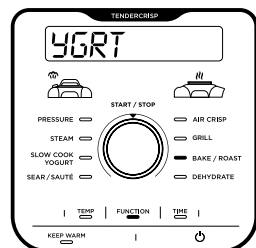

- 4 Press TIME, then turn the dial to adjust the incubation time in 30-minute increments between 8 and 12 hours.

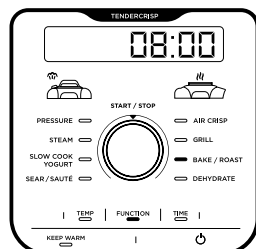

NOTE: Selecting a longer time will lead to tangier yogurt with a thicker consistency. Use 12 hours to achieve Greek-style yogurt.

- 5 Press START/STOP to begin pasteurisation.

- 6 Unit will display BOIL while pasteurizing. When pasteurisation temperature is reached, the unit will beep and display COOL.

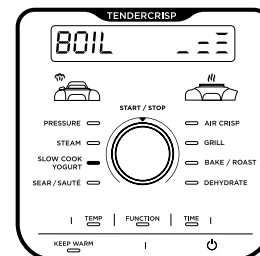

- 7 Once the milk has cooled, the unit will display ADD And STIR in succession and the incubation time.

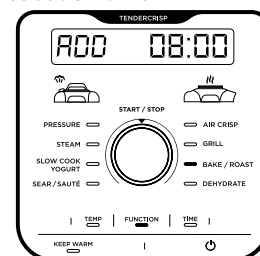

- 8 Remove the pressure lid and skim the top of the milk.

- 9 Add yogurt cultures to milk and stir to combine. Install the pressure lid and press START/STOP to begin incubation process.

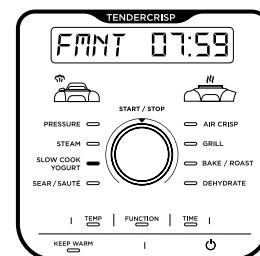

- 10 The display will show FMNT and will begin counting down. When incubation time is complete, the unit will beep and display DONE. The unit will beep each minute for up to 4 hours or until powered off.

- 11 Chill yogurt up to 12 hours before serving.

Sear/Sauté

- 1 Add ingredients to the pot.

- 2 Press FUNCTION, then turn the dial to select SEAR/SAUTÉ. The default temperature setting will display. Press TEMP, then turn the dial to select LO, LO:MD, MD, MD:HI, or HI.

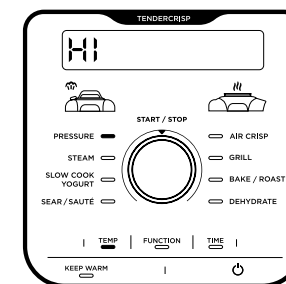

NOTE: There is no time adjustment available when using the Sear/Sauté function.

- 3 Press START/STOP to begin cooking.

- 4 Press START/STOP to turn off the SEAR/SAUTÉ function. To switch to a different cooking function, press FUNCTION, then turn the START/STOP dial to your desired cooking function.

NOTE: You can use this function with the crisping lid open or with the pressure lid with the pressure release valve in the VENT position.

NOTE: ALWAYS use nonstick utensils in the cooking pot. **DO NOT** use metal utensils, as they will scratch the nonstick coating on the pot.

ACCESSORIES FOR PURCHASE

Ninja offers a variety of accessories custom made for your Ninja® Foodi® 2 Tier TenderCrisp™ Pressure Cooker. Visit ninjakitchen.eu to expand your capabilities and take your cooking to the next level.

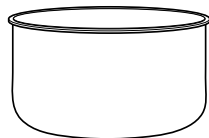

Cooking Pot

An extra pot so you can keep the Foodi® fun going when your other pot is already full of delicious food.

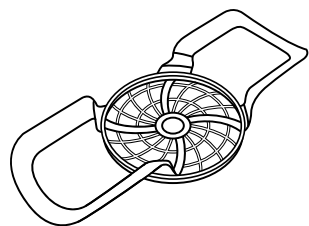

Multi-Purpose Silicone Sling

Easily lift ingredients and pans into and out of the cooking pot.



Multi-Purpose Tin

Create casseroles, dips, and sweet and savory pies, or bake a fluffy, moist cake with a golden top for dessert. D22cm H6cm.

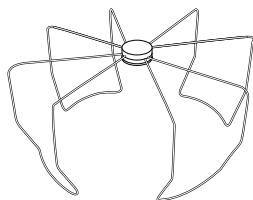

Folding Crisping Rack

Cook an entire pack of bacon or turn tortillas into taco shells.

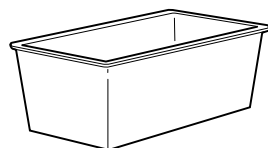

Loaf Pan

Our specially designed pan is the perfectly sized baking accessory for bread mixes like banana and courgette. L21cm x W11cm x H9cm approx.

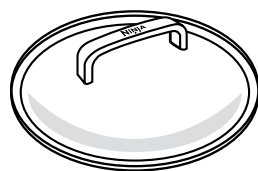

Glass Lid

See into the pot during multiple cooking functions, then use to transport or store easily.



Extra Pack of Silicone Rings

2-pack silicone ring set helps keep flavours separate—use one when cooking savory foods and the other when cooking sweet foods.

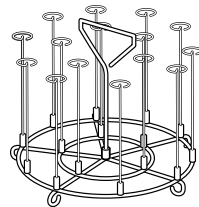

Skewer Stand

Only compatible with the 7.5L models. Use the skewer stand to create kebabs. 15 skewers included.

CLEANING & MAINTENANCE

Cleaning: Dishwasher & Hand-Washing

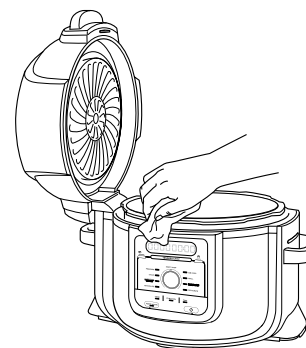

The unit should be cleaned thoroughly after every use.

- 1 Unplug the unit from the wall socket before cleaning.
- 2 To clean the cooker base and the control panel, wipe them clean with a damp cloth.
- 3 The pressure lid and cooking pot, silicone ring, reversible rack, Cook & Crisp™ Basket, and detachable diffuser can be washed in the dishwasher.

NOTE: NEVER put the cooker base in the dishwasher, or immerse it in water or any other liquid.

- 4 The pressure lid, including the pressure release valve and anti-clog cap, can be washed with water and dish soap.
- 5 To clean the crisping lid, wipe it down with a wet cloth or paper towel after the heat shield cools.
- 6 If food residue is stuck on the cooking pot, reversible rack, or Cook & Crisp Basket, fill the pot with water and allow to soak before cleaning. **DO NOT** use scouring pads. If scrubbing is necessary, use a non-abrasive cleanser or liquid dish soap with a nylon pad or brush.
- 7 Air-dry all parts after each use.

NOTE: DO NOT take apart the pressure release valve or float valve assembly.

Removing & Reinstalling the Silicone Ring

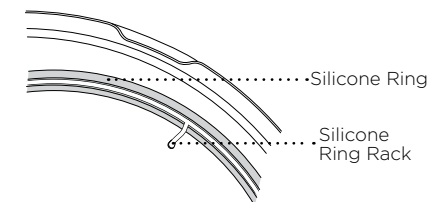
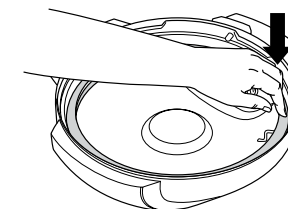
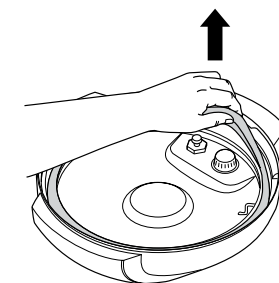

To remove the silicone ring, pull it outward, section by section, from the silicone ring rack. The ring can be installed with either side facing up. To reinstall, press it down into the rack section by section.

After use, remove any food debris from the silicone ring and anti-clog cap.

Keep the silicone ring clean to avoid odour

Washing it in warm, soapy water or in the dishwasher can remove odour. However, it is normal for it to absorb the smell of certain acidic foods. It is recommended to have more than one silicone ring at hand. You can purchase additional silicone rings on ninjakitchen.eu

NEVER pull out the silicone ring with excessive force, as this may deform it and the rack and affect the pressure-sealing function. A silicone ring with cracks, cuts, or other damage should be replaced immediately.

TROUBLESHOOTING GUIDE

Why is my unit taking so long to come to pressure? How long does it take to come to pressure?

- Cooking times may vary based on the selected temperature, current temperature of the cooking pot, and temperature or quantity of the ingredients.
- Check to make sure your silicone ring is fully seated and flush against the lid. If installed correctly, you should be able to tug lightly on the ring to rotate it.
- Check that the pressure lid is fully locked, and the pressure release valve is in the SEAL position when pressure cooking.

Why is the time counting down so slowly?

- You may have set hours rather than minutes. When setting time, the display will show HH:MM and the time will increase/decrease in minute increments.

How can I tell when the unit is pressurising?

- The rotating lights will display on the screen to indicate the unit is building pressure.

PRE and moving lights are shown on the display screen when using the Pressure or Steam function.

- This indicates the unit is building pressure or preheating when using STEAM or PRESSURE. When the unit has finished building pressure, your set cook time will begin counting down.

There is a lot of steam coming from my unit when using the Steam function.

- It's normal for steam to release through the pressure release valve during cooking. Leave the pressure release valve in the VENT position for Steam, Slow Cook, and Sear/Sauté.

Why can't I take the pressure lid off?

- As a safety feature, the pressure lid will not unlock until the unit is completely depressurised. Turn the pressure release valve to the VENT position to quick release the pressurised steam. A quick burst of steam will spurt out of the pressure release valve. When the steam is completely released, the unit will be ready to open. Turn the pressure lid counterclockwise, then lift it up and away from you.

Is the pressure release valve supposed to be loose?

- Yes. The pressure release valve's loose fit is intentional; it enables a quick and easy transition between SEAL and VENT and helps regulate pressure by releasing small amounts of steam during cooking to ensure great results. Please make sure it is turned as far as possible toward the SEAL position when pressure cooking and as far as possible toward the VENT position when quick releasing.

The unit is hissing and not reaching pressure.

- Make sure the pressure release valve is turned to the SEAL position. If you've done this and still hear a loud hissing noise, it may indicate your silicone seal is not fully in place. Press START/STOP to stop cooking, VENT as necessary, and remove the pressure lid. Press down on the silicone ring, ensuring it is fully inserted and lies flat under the ring rack. Once fully installed, you should be able to tug lightly on the ring to rotate it.

The unit is counting up rather than down.

- The cooking cycle is complete and the unit is in Keep Warm mode.

How long does the unit take to depressurise?

- Quick release is about 2 minutes or less. Natural release can take up to 20 minutes or more, depending on the type of food and/or the amount of liquid and food in the pot.

“ADD POT” error message appears on display screen.

- Cooking pot is not inside the cooker base. Cooking pot is required for all functions.

“OTHR LID” error message appears on display screen and lid icon flashes.

- The incorrect lid is installed for your desired cooking function. Install the pressure lid to use the Pressure, Slow Cook, Yogurt, Steam, or Keep Warm functions.

“SHUT LID” error message appears on display screen.

- The crisping lid is open and needs to be closed for the selected function to start.

“TURN LID” error message appears on display screen.

- The pressure lid is not fully installed. Turn the pressure clockwise until it clicks to use the Pressure, Slow Cook, Yogurt, Steam, and Keep Warm functions.

“OPEN VENT” error message appears on display screen.

- When set to Slow Cook or Sear/Sauté, and the unit senses pressure building up, this message indicates the pressure release valve is in the SEAL position.
- Turn the pressure release valve to the VENT position and leave it there for the remainder of the cooking function.
- If you do not turn the pressure release valve to the VENT position within 5 minutes, the program will cancel and the unit will shut off.

“ADD WATR” error message appears on display screen when using the Steam function.

- The water level is too low. Add more water to the unit for the function to continue.

“ADD WATR” error message appears on display screen when using the Pressure function.

- Add more liquid to the cooking pot before restarting the pressure cook cycle.
- Make sure the pressure release valve is in the SEAL position.
- Make sure the silicone ring is installed correctly.

“ERR” message appears.

- The unit is not functioning properly. Please contact Customer Service at 0800 862 0453.

HELPFUL TIPS

- 1** For consistent browning, make sure ingredients are arranged in an even layer on the bottom of the cooking pot with no overlapping. If ingredients are overlapping, make sure to shake half way through the set cook time.
- 2** For smaller ingredients that could fall through the reversible rack, we recommend first wrapping them in a parchment paper or foil pouch.
- 3** When switching from pressure cooking to using the crisping lid it is recommended to empty the pot of any remaining liquid for best crisping results.
- 4** Use the Keep Warm mode to keep food at a warm, food-safe temperature after cooking. To prevent food from drying out, we recommend keeping the lid closed and using this function just before serving. To reheat food, use the Air Crisp function.
- 5** When using a recipe for the Ninja Foodi® 6L in this unit, some additional cooking time, or extra shake of the Cook & Crisp™ Basket may be required.
- 6** 6L pressure recipes like soups, stews, and chilies can be scaled up by 50% in the Ninja® Foodi® Max.

REPLACEMENT PARTS

To order additional parts and accessories, visit ninjakitchen.eu or contact Customer Service at 0800 862 0453.

PRODUCT REGISTRATION

Please visit registeryourninja.com or call 0800 862 0453 to register your new Ninja® product within 28 days of purchase. You will be asked to provide the store name, date of purchase, and model number along with your name and address.

The registration will enable us to contact you in the unlikely event of a product safety notification. By registering, you acknowledge you have read and understood the instructions for use and warnings set forth in the accompanying instructions.

VISIT US ONLINE AT:

ninjakitchen.eu

Or follow us on any of our social media pages:



@ninjakitchenuk



NOTE: Save these instructions. Keep for future reference.



This marking indicates this product should not be disposed of with other household wastes throughout the EU. To prevent possible harm to the environment or human health from uncontrolled waste disposal, recycle it responsibly to promote the sustainable reuse of material sources. To return your used device, please use the return and collection systems or contact the retailer where this product was purchased. They can take this product for environmentally safe recycling.

Euro-Pro Europe Limited

3150 Century Way,

Thorpe Park,

Leeds,

LS15 8ZB

0800 862 0453

ninjakitchen.eu

Illustrations may differ from actual product. We are constantly striving to improve our products, therefore the specifications contained herein are subject to change without notice.

NINJA and FOODI are registered trademarks of SharkNinja Operating LLC.

TENDERCRISP and COOK & CRISP are trademarks of SharkNinja Operating LLC.

© 2019 SharkNinja Operating LLC

OP500UK_IB_REV_190708_MV1
PRINTED IN CHINA

