

ARCTIS 7+ WIRELESS

PRODUCT INFORMATION GUIDE



CONTENTS

Product overview	5–6	Translations	
Setup	7	Español	17
Charging	9	简体中文	19
Power On/Off	10	繁體中文	21
Pairing	11	日本語	23
Microphone	12	한국어	25
Multimedia Control	13	Deutsch	27
Ski Goggle Headband	14	Русский	29
ChatMix Setup	15	Français	31
		Italiano	33
		Português	35
		Polski	37
		Regulatory	39

WELCOME TO ARCTIS

Your new headset is the result of gaming expertise since 2001 and our unyielding pursuit of perfection. We poured our hearts into making your new Arctis, giving it the best gaming mic available, 7.1 surround sound and comfort and style unlike anything you've experienced before.

Arctis is our glory; now go chase yours.

STEELSERIES GG

Find help at support.steelseries.com

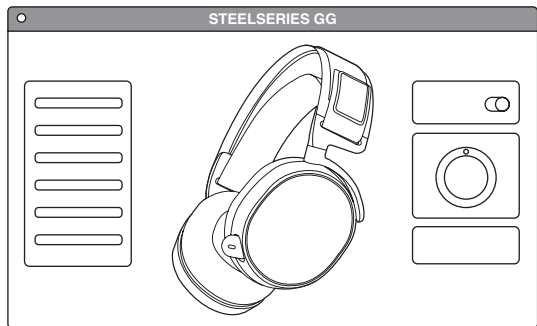

Download SteelSeries GG to customize your audio settings, setup ChatMix, use surround sound and to integrate with Engine Apps like Discord: steelseries.com/gg

PACKAGE CONTENTS

- Product Information Guide
- Artcis 7+ Wireless Headset
- USB-C Wireless Dongle
- USB-C to USB-A Adapter Cable
- 4-pole 3.5 mm Audio Cable
- USB-C Charging Cable

SYSTEM COMPATIBILITY

- PC
- Mac
- PlayStation 5
- PlayStation 4
- Nintendo Switch
- Android (with USB-C)

PRODUCT OVERVIEW

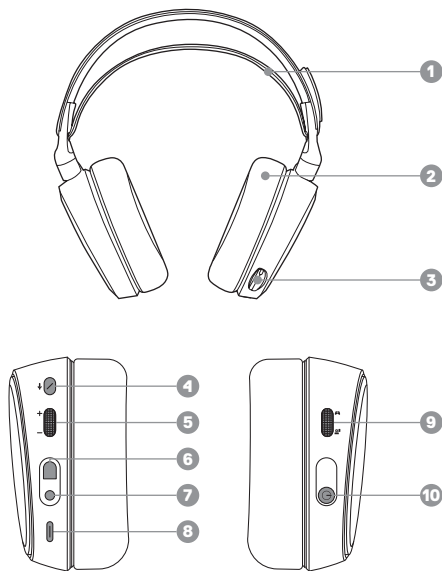

- 1 Ski Goggle Headband*
- 2 Airweave Ear Cushions*
- 3 Retractable Microphone
- 4 Microphone Mute Button
- 5 Volume Control
- 6 Mobile Cable Jack
- 7 Headphone Share Jack
- 8 USB-C Charging Jack
- 9 ChatMix Dial
- 10 Power Button

- 11 USB-C Wireless Dongle
- 12 USB-C to USB-A Adapter Cable
- 13 USB-C Charging Cable
- 14 4-pole 3.5 mm Audio Cable*

*Find accessories at steelseries.com/gaming-accessories

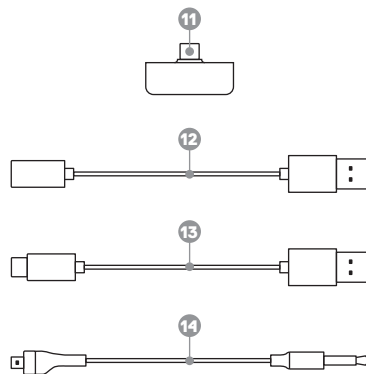

SETUP

More detailed product information at steelseries.com/arctis-7x

WIRELESS SETUP

Connection to USB-A

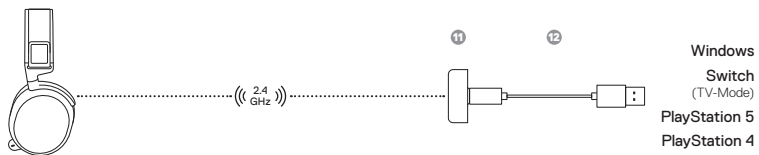

Connection to USB-C

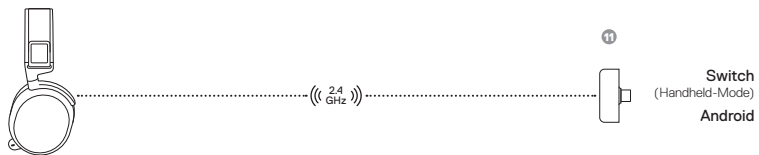

WIRED SETUP

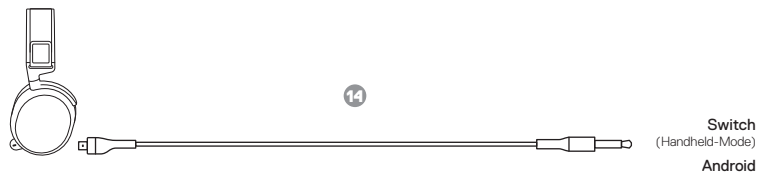

CHARGING

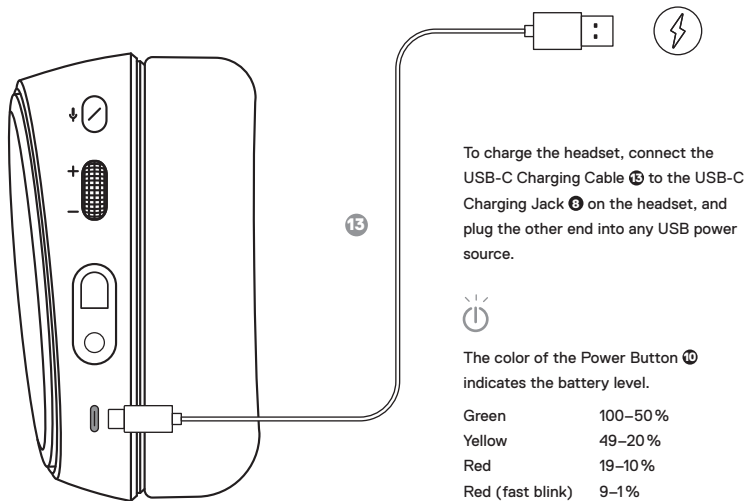

POWER ON/OFF

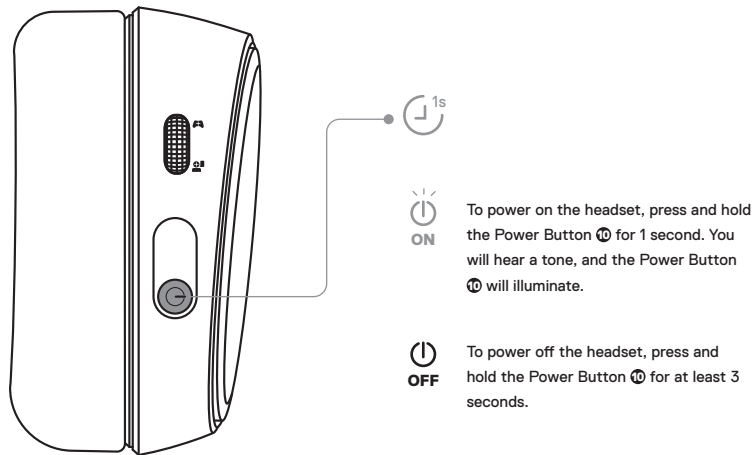

PAIRING



Note: The headset is already paired with the Dongle out of the box. To re-pair the Dongle:

- 1 Connect the USB-C Wireless Dongle 11 to a Windows PC with SteelSeries GG installed.
- 2 Use the 13 USB-C Charging Cable to connect the headset to the same PC.
- 3 Use Engine from SteelSeries GG software to initiate the pairing.
- 4 Engine will show when pairing is completed.

MICROPHONE

RETRACTABLE MICROPHONE

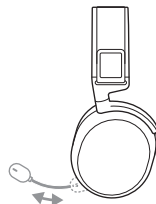



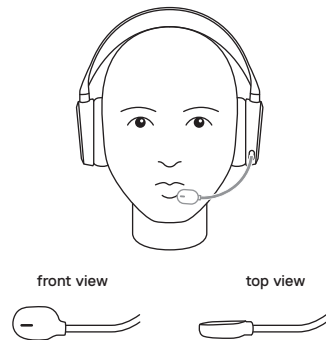

POSITIONING

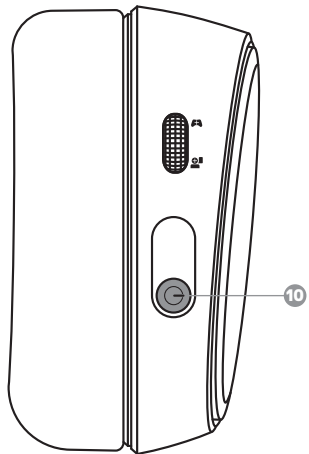

Position the ClearCast Microphone 5 close to the corner of your mouth with the flat surface facing you.

MULTIMEDIA CONTROL



-  Answer/end voice call
single · press Power Button 10
-  Play/pause music
single · press Power Button 10
-  Next track
double · · press Power Button 10
-  Previous track
triple · · · press Power Button 10

SKI GOGGLE HEADBAND

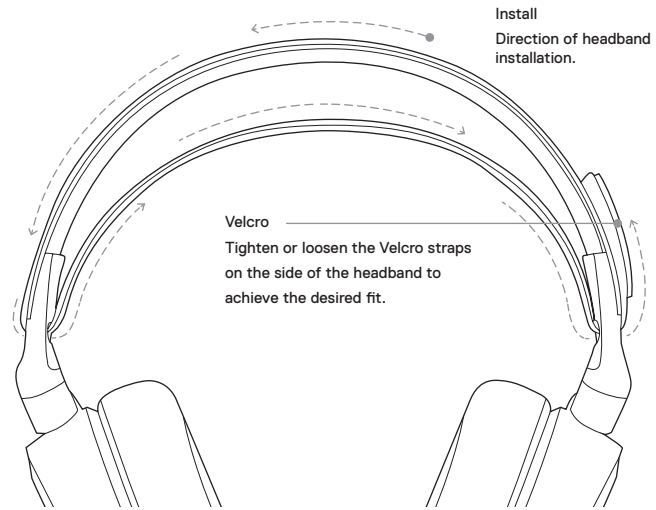

CHATMIX SETUP

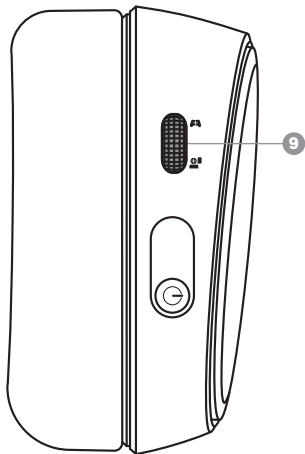

CHATMIX DIAL

Download and install SteelSeries GG, then run GG's first time audio setup. After finishing setup, the ChatMix Dial **9**, can be used to control the balance between how much you hear of the game audio vs chat audio from your voice communication application.

ESPAÑOL

CONTENIDO DEL PAQUETE

Guía de información sobre el producto

Arctis 7+ auricular inalámbrico

Dongle inalámbrico USB-C

Cable adaptador USB-C a USB-A

Cable de audio de 3,5 mm, 4 polos

Cable de carga USB-C

COMPATIBILIDAD DEL SISTEMA

PC, Mac, PlayStation 5, PlayStation 4, Nintendo Switch, Android (con USB-C)

Ayuda en support.steelseries.com

RESUMEN DEL PRODUCTO

- 1 Cinta de gran confort*
- 2 Almohadillas de cuero AirWeave*
- 3 Micrófono retráctil
- 4 Botón para silenciar el micrófono
- 5 Control del volumen
- 6 Conector para cable de móvil
- 7 Conector para compartir auriculares
- 8 Conector de carga USB-C
- 9 Perilla ChatMix
- 10 Botón de encendido

11 Dongle inalámbrico USB-C

12 Cable adaptador USB-C a USB-A

13 Cable de carga USB-C

14 Cable de audio de 3,5 mm, 4 polos*

*Los accesorios están en steelseries.com/gaming-accessories

CONFIGURACIÓN

CONFIGURACIÓN INALÁMBRICA

Conexión a USB-A

Conexión a USB-C

CONFIGURACIÓN CON CABLE

Información de producto detallada en steelseries.com/arctis-7x

CARGA

Para cargar el auricular, conecta el cable de carga USB-C **8** al conector de carga USB-C **8** del auricular y enchufa el otro extremo a cualquier fuente de alimentación USB.

El color del botón de encendido **10** indica el nivel de carga.

verde	100-50 %
amarillo	49-20 %
rojo	19-10 %
rojo (parpadeo rápido)	9-1 %

ENCENDER/APAGAR

Para encender los auriculares, mantén presionado

el botón de encendido **10** durante 1 segundo. Escucharás un sonido y el botón de encendido **10** se iluminará.

Para apagar los auriculares, mantén presionado el botón de encendido **10** durante al menos 3 segundos.

EMPAQUEAMIENTO

Aviso: El auricular ya viene emparejado con el dongle. Para volver a emparejar el dongle:

- 1 Conecta el dongle inalámbrico USB-C **11** a un PC con Windows que tenga instalado Steelseries GG.
- 2 Utiliza el **13** cable de carga USB-C para conectar los auriculares a ese mismo PC.
- 3 Utiliza Engine del software Steelseries GG para iniciar el emparejamiento.
- 4 Engine te avisará cuando se haya realizado el emparejamiento.

MICRÓFONO

MICRÓFONO RETRÁCTIL

COLOCACIÓN

vista frontal

vista superior

Coloca el micrófono ClearCast **3** cerca de la

comisura de los labios con la superficie plana apuntando hacia ti.

CONTROL MULTIMEDIA

 Responder/finalizar llamada de voz pulsar · una vez el botón de encendido **10**

 Reproducir/pausar música pulsar · una vez el botón de encendido **10**

 Siguiete pista pulsar · dos veces el botón de encendido **10**

 Pista anterior pulsar · tres veces el botón de encendido **10**

CINTA DE GRAN CONFORT

Instalar

Ajuste de la dirección de la cinta.

Velcro

Aprieta o afloja las tiras de velcro por el lado de la cinta para que se ajuste como tú prefieres.

CONFIGURACIÓN DE CHATMIX

PERILLA CHATMIX

Descarga e instala Steelseries GG y luego ejecuta la primera configuración para audio de GG. Una vez concluida la configuración, la perilla ChatMix **9** se puede utilizar para ajustar el balance del audio del juego y el audio del chat que viene de tu aplicación para la comunicación.

简体中文

包装内容

产品信息指南

Artcis 7+ 无线耳机

USB-C 无线收发器

USB-C 转 USB-A 适配器电缆

4 极 3.5 mm 音频线

USB-C 充电线

系统兼容性

个人电脑, Mac, PlayStation 5, PlayStation 4, Nintendo Switch, 安卓 (带 USB-C)

如需帮助, 请访问 support.steelseries.com

产品概览

- 1 滑雪护目镜头带*
- 2 Airweave 耳垫*
- 3 可伸缩麦克风
- 4 麦克风静音按钮
- 5 音量控制
- 6 移动电缆插孔
- 7 耳机共享插孔
- 8 USB-C 充电插孔
- 9 ChatMix 控制盘

10 电源按钮

11 USB-C 无线收发器

12 USB-C 转 USB-A 适配器电缆

13 USB-C 充电线

14 4 极 3.5 mm 音频线*

*在 steelseries.com/gaming-accessories 查找配件

设置

无线设置

连接至 USB-A

连接至 USB-C

有线设置

更多详细的产品信息, 请访问 steelseries.com/arctis-7x

充电

若要给耳机充电, 请将 USB-C 充电线连接到耳机上的 **13** USB-C 充电插孔 **8**, 并将另一端插入任何 USB 电源。

电源按钮 **10** 的颜色表示电池电量。

绿色	100-50 %
黄色	49-20 %
红色	19-10 %
红色 (快闪)	9-1 %

电源开/关

若要打开耳机电源, 按住电源按钮 10 1 秒。您将听到提示音, 且电源按钮 10 将亮起。

若要关闭耳机电源, 按住电源按钮 10 至少 3 秒。

配对

注意: 耳机开箱即用, 已与收发器配对。若要重新配对收发器:

- 1 将 USB-C 无线收发器 11 连接到安装有 SteelSeries GG 的 Windows 电脑。
- 2 使用 13 USB-C 充电线, 将耳机连接到同一台电脑。
- 3 使用 SteelSeries GG 软件中的引擎, 启动配对。
- 4 配对完成后, 引擎将相应显示。

麦克风

可伸缩麦克风

定位

正视图

俯视图

将 ClearCast 麦克风 5 靠近您的嘴角, 且平面朝向您。

多媒体控制

接听/结束语音通话
按下一次·电源按钮 10

播放/暂停音乐
按下一次·电源按钮 10

下一首曲目
按下两次···电源按钮 10

上一首曲目
按下三次···电源按钮 10

滑雪护目镜头带

安装
头带安装方向。

尼龙搭扣
紧固或松开头带侧面的尼龙搭扣带, 以达到理想的贴合度。

CHATMIX 设置

CHATMIX 控制盘

下载和安装 SteelSeries GG, 然后, 运行 GG 的首次音频设置。设置完成后, ChatMix 控制盘 9 可用于控制您从语音通信应用程序听到的游戏音频与聊天音频之间的平衡。

繁體中文

包裝內容

產品資訊指南

Arctis 7+ 無線耳機

USB-C 無線收發器

USB-C 轉 USB-A 轉接器纜線

4 極 3.5mm 音訊線

USB-C 充電線

系統相容性

PC, Mac, PlayStation 5, PlayStation 4, Nintendo Switch, Android (帶 USB-C)

如需幫助, 請訪問 support.steelseries.com

產品概覽

- 1 滑雪護目鏡頭帶*
- 2 Airweave 耳墊*
- 3 可伸縮麥克風
- 4 麥克風靜音按鈕
- 5 音量控制
- 6 移動纜線插孔
- 7 耳機共用插孔
- 8 USB-C 充電插孔
- 9 ChatMix 控制盤

10 電源按鈕

11 USB-C 無線收發器

12 USB-C 轉 USB-A 轉接器纜線

13 USB-C 充電線

14 4 極 3.5mm 音訊線*

* 在 steelseries.com/gaming-accessories 找尋配件

設定

無線設定

連接至 USB-A

連接至 USB-C

有線設定

如需更多產品詳情, 請造訪 steelseries.com/arctis-7x

充電

若要給耳機充電, 請將 USB-C 充電線連接到耳機上的 13 USB-C 充電插孔 8, 並將另一端插入任何 USB 電源。

電源按鈕 10 的顏色表示電池電量。

綠色	100-50 %
黃色	49-20 %
紅色	19-10 %
紅色 (快閃)	9-1 %

電源開/關

若要開啟耳機電源，按住電源按鈕 10 1 秒。您將聽到提示音，且電源按鈕 10 將亮起。

若要關閉耳機電源，按住電源按鈕 10 至少 3 秒。

配對

注意：耳機開箱即用，已與收發器配對。若要重新配對收發器：

- 1 將 USB-C 無線收發器 11 連接到安裝有 SteelSeries GG 的 Windows 電腦。
- 2 使用 12 USB-C 充電線，將耳機連接到同一台電腦。
- 3 使用 SteelSeries GG 軟體中的引擎，啟動配對。
- 4 配對完成後，引擎將相應顯示。

麥克風

可伸縮麥克風

定位

正視圖

俯視圖

將 ClearCast 麥克風 13 靠近您的嘴角，且平面朝向您。

多媒體控制

📞 接聽/結束語音通話
按下一次·電源按鈕 10

⏮ 播放/暫停音樂
按下一次·電源按鈕 10

▶▶ 下一首曲目
按下兩次···電源按鈕 10

◀◀ 上一首曲目
按下三次···電源按鈕 10

滑雪護目鏡頭帶

安裝
頭帶安裝方向。

尼龍搭扣
緊固或鬆開頭帶側面的尼龍搭扣帶，以達到理想的貼合度。

CHATMIX 設定

CHATMIX 控制盤

下載和安裝 SteelSeries GG，然後，運行 GG 的首次音訊設定。設定完成後，ChatMix 控制盤 14 可用於控制您從語音通信應用程式聽到的遊戲音訊與聊天音訊之間的平衡。

日本語

パッケージ内容

商品情報ガイド

Arctis 7+ ワイヤレスヘッドセット

USB-C ワイヤレスドングル

USB-C & USB-A アダプターケーブル

4極3.5mm オーディオケーブル

USB-C 充電ケーブル

システム互換性

PC, Mac, PlayStation 5, PlayStation 4, Nintendo Switch, Android (USB-C を使用)

support.steelseries.com でヘルプを参照してください

商品概要

- 1 スキーゴーグルにも使用される快適なヘッドバンド*
- 2 AirWeave イヤークッション*
- 3 格納式マイク
- 4 マイクミュートボタン
- 5 音量コントロール
- 6 モバイルケーブルジャック
- 7 ヘッドフォンシエアジャック
- 8 USB-C 充電ジャック

9 CHATMIX ダイヤル

10 電源ボタン

11 USB-C ワイヤレスドングル

12 USB-C & USB-A アダプターケーブル

13 USB-C 充電ケーブル

14 4極3.5mm オーディオケーブル*

*steelseries.com/gaming-accessories でアクセサリをお求めいただけます

設定

ワイヤレス接続設定

USB-A への接続

USB-C への接続

有線接続設定

詳しい商品情報はこちら steelseries.com/arctis-7x

充電

ヘッドセットを充電するには、USB-C 電源ケーブル 15 をヘッドセットの USB-C 充電ジャック 8 に接続し、反対の先端を USB 電源に差し込みます。

電源ボタン 10 の色がバッテリーレベルを表示します。

緑	100~50%
黄	49~20%
赤	19~10%
赤 (高速点滅)	9~1%

電源オン/オフ

電源ボタン ⑩を1秒間押ししてホールドすると、ヘッドセットの電源がオンになります。電源がオンになるとトーンが鳴り、電源ボタン ⑩が点灯します。

電源ボタン ⑩を最低3秒間押ししてホールドすると、ヘッドセットの電源がオフになります。

ペアリング

注:ヘッドセットは開封時すでにドングルとペアリングされています。再度ドングルとペアリングする方法は以下の通りです。

- 1 USB-Cワイヤレスドングル ⑪を、SteelSeries GGがインストールされているWindows PCに接続します。
- 2 ⑬ USB-C充電ケーブルを使用して、ヘッドセットを同じPCに接続します。
- 3 Steelseries GGソフトウェアのエンジンを使用してペアリングを開始します。
- 4 ペアリングが完了するとエンジンがその旨を表示します。

マイク

格納式マイク

配置

正面からの図

上からの図

ClearCastマイク ⑨を、平らな面がご自身の方を向くようにして、口元の近くに配置してください。

マルチメディアコントロール

📞 音声電話の応答/終了
電源ボタン ⑩を1度・押し

⏮ 音楽の再生/停止
電源ボタン ⑩を1度・押し

▶▶ 次の曲へ移動
電源ボタン ⑩を2度・押し

◀◀ 前の曲へ移動
電源ボタンを3度・押し ⑩

スキーゴーグルにも使用される快適なヘッドバンド

インストール
ヘッドバンドをインストールする方向

マジックテープ
ヘッドバンドの横のマジックテープのついたストラップを締めて、または緩めて、ご希望のフィット感に調節します。

CHATMIXの設定

CHATMIXダイヤル

Steelseries GGをダウンロードおよびインストールして、GGの初期オーディオ設定を行います。設定が完了したらCHATMIXダイヤル ⑨を使用して、ゲーム音声と、音声通信アプリからのチャット音声のバランスを調節できます。

한국어

패키지 내용

제품 정보 가이드

Arctis 7+무선 헤드셋

USB-C 무선 동글

USB-C에서 USB-A 어댑터 케이블

4-폴 3.5mm 오디오 케이블

USB-C 충전 케이블

시스템 호환성

PC, Mac, PlayStation 5, PlayStation 4, Nintendo Switch, Android (USB-C와 함께)
support.steelseries.com을 통해 도움말을 확인하십시오.

제품 개요

- 1 Ski Goggle 헤드밴드*
- 2 Airweave 귀 쿠션*
- 3 안으로 집어넣을 수 있는 마이크
- 4 마이크 음소거 버튼
- 5 볼륨 컨트롤
- 6 이동식 케이블 잭
- 7 헤드폰 공유 잭
- 8 USB-C 충전 잭
- 9 ChatMix Dial

10 전원 버튼

11 USB-C 무선 동글

12 USB-C에서 USB-A 어댑터 케이블

13 USB-C 충전 케이블

14 4-폴 3.5mm 오디오 케이블*

*steelseries.com/gaming-accessories에서 부속품과 대체품을 찾으십시오.

설정

무선 설정

USB-A로 연결

USB-C로 연결

유선 설정

steelseries.com/setup/arena-7에서 더 자세한 제품 정보를 확인하십시오.

충전

헤드셋을 충전하려면, USB-C 충전 케이블 ⑬을 헤드셋의 USB-C 충전 잭 ⑨에 연결하고, 반대쪽 끝은 USB 전원에 연결하십시오.

전원 버튼의 색깔은 ⑩배터리의 남은 정도를 나타냅니다.

녹색	100-50% 노란색	49-20%
빨간색	19-10%	
빨간색(빠르게 깜빡거림)	9-1%	

전원 켜짐/꺼짐

헤드셋을 켜려면, 전원 버튼을 ⑩ 약 1초간 누르고 있으십시오. 그러면 신호음이 들리고 전원 버튼에 ⑩ 불이 들어옵니다.

헤드셋을 끄려면, 전원 버튼을 ⑩ 약 3초간 누르고 있으십시오.

페어링

알림: 헤드셋은 이미 박스에서 꺼낸 동글과 페어 되어 있습니다. 동글과 다시 페어링하려면:

- 1 USB-C 무선 동글을 ⑪ Windows PC에 설치된 SteelSeries GG에 연결하십시오.
- 2 ⑬ USB-C 충전 케이블을 사용해 같은 PC의 헤드셋에 연결하십시오.
- 3 SteelSeries GG 소프트웨어 엔진을 사용해 페어링을 시작합니다.
- 4 페어링이 끝나면 엔진이 표시됩니다.

마이크

안으로 집어넣을 수 있는 마이크

위치

앞쪽

뒤쪽

ClearCast 마이크가 귀하를 향하도록 해 입의 모서리에 ⑤ 울(를) 가까이 둡니다.

멀티미디어 컨트롤

☎ 음성 통화 받기/끄기 · 모양 전원 버튼 누르기 ⑩

▶▶ 음악 플레이/일시 정지 · 모양 전원 누르기 ⑩

▶▶ 다음 트랙 · · 모양 전원 버튼 누르기 ⑩

◀◀ 이전 트랙 · · · 모양 전원 버튼 누르기 ⑩

SKI GOGGLE 헤드밴드

설치
헤드밴드 설치 방향

벨크로
딱 맞고 고정하기 위해 헤드밴드 옆의 벨크로 스트랩을 조이거나 느슨하게 합니다.

CHATMIX 설정

CHATMIX 다이얼

SteelSeries GG를 다운로드해 설치하고 GG의 첫 오디오 설정을 작동 시킵니다. 설정이 끝나면, ChatMix 다이얼은 ⑨ 귀하가 게임 오디오와 음성 통신 앱의 채팅 오디오 간의 균형을 잡는데 사용됩니다.

DEUTSCH

LIEFERUMFANG

Produkt-Informationshandbuch

Arctis 7+ Wireless Headset

USB-C-Wireless-Dongle

USB-C- auf USB-A-Adapterkabel

4-poliges 3,5-mm-Audiokabel

USB-C-Ladekabel

KOMPATIBILITÄT

PC, Mac

PlayStation 5, PlayStation 4, Nintendo Switch, Android (via USB-C)

weitere Unterstützung gibt es unter support.steelseries.com

PRODUKTÜBERSICHT

- 1 Skibrillen-Kopfriemen*
- 2 AirWeave Leder-Ohrpolster*
- 3 Einziehbares Mikrofon
- 4 Mikrofon-Stummschalttaste
- 5 Lautstärkeregler
- 6 Anschluss für mobiles Audiokabel
- 7 Anschluss für zusätzlichen Kopfhörer
- 8 USB-C-Ladeanschluss

9 Chatmix-Regler

10 Power-Taste

11 USB-C-Wireless-Dongle

12 USB-C- auf USB-A-Adapterkabel

13 USB-C-Ladekabel

14 4-poliges 3,5-mm-Audiokabel*

*Zubehör gibt es unter steelseries.com/gaming-accessories

EINRICHTUNG

HERSTELLEN DER DRAHTLOSVERBINDUNG

Anschluss zu UBC-A

Anschluss zu UBC-C

HERSTELLEN DER KABELGEBUNDENEN VERBINDUNG

Weitere Produktinformationen erhältst du unter steelseries.com/arctis-7x

LADEVORGANG

Um das Headset zu laden, schließe das USB-C-Ladekabel ⑬ an den USB-C-Ladeanschluss ⑧ am Headset an. Verbinde das andere Kabelende zur Stromversorgung an einen beliebigen USB-Anschluss.

Die Farbe der Power-Taste ⑩ zeigt den Akkustand an.

Grün

100–50 %

Gelb	49–20 %
Rot	19–10 %
Rot (schnelles Blinken)	9–1 %

EIN- UND AUSSCHALTEN

Um das Headset einzuschalten, halte die Power-Taste **10** 1 Sekunde gedrückt. Du hörst einen Ton und die Power-Taste **10** beginnt zu leuchten.

Um das Headset auszuschalten, halte die Power-Taste **10** für mindestens 3 Sekunden gedrückt.

KOPPELN

Hinweis: Das Headset ist bereits vom Werk aus mit dem Dongle gekoppelt. Um die Verbindung zum Dongle erneut herzustellen:

- 1 Stecke den USB-C-Wireless-Dongle **11** mit einem Windows-PC, auf dem SteelSeries GG installiert ist.
- 2 Verbinde anschließend das Headset über das USB-C-Ladekabel **12** mit dem PC.
- 3 Öffne die SteelSeries GG-Software, navigiere zu „Engine“, um das Headset zu koppeln.
- 4 Die „Engine“-Ansicht zeigt dir, wenn die Verbindung erfolgreich hergestellt ist.

MIKROFON

EINZIEHBARES MIKROFON

POSITIONIERUNG

Ansicht von vorne

Ansicht von oben

Positioniere das ClearCast-Mikrofon **3** nahe an deinem Mundwinkel, mit der flachen Seite Richtung Gesicht.

MULTIMEDIA-STEUERUNG

☎ Anruf entgegennehmen/beenden
Power-Button **10** einmal · drücken

||▶ Anruf entgegennehmen/beenden
Power-Button **10** einmal · drücken

▶▶ Nächster Titel
Power-Button **10** einmal · · drücken

◀◀ Vorheriger Titel
Power-Button · · · dreimal drücken **10**

SKIBRILLEN-KOPFRIEMEN

Installation
Anweisung zur Installation des Kopfriemens

Klettbänder
Ziehe die Klettbänder an der Seite des Kopfriemens an oder lockere sie, bis die gewünschte Passform erreicht ist.

CHATMIX-EINRICHTUNG

CHATMIX-REGLER

Lade SteelSeries GG herunter, installiere es und führe das GG-Audiosetup aus. Wenn das Setup abgeschlossen ist, kannst du den Chatmix-Regler **9** verwenden, um den Mix zwischen Game- und Chat-Audio aus deinem Voicechat-Tool anzupassen.

РУССКИЙ

СОДЕРЖИМОЕ УПАКОВКИ

- Руководство по продукту
- Беспроводная гарнитура Arctis 7+
- Беспроводной ключ USB-C
- Кабель-адаптер USB-C к USB-A
- 4-полюсный аудио кабель 3,5 мм
- Зарядный кабель USB-C

СОВМЕСТИМОСТЬ С СИСТЕМАМИ

ПК, Mac, PlayStation 5, PlayStation 4, Nintendo Switch, Android (через USB-C)
Обращайтесь за помощью на сайт support.steelseries.com

ОБЗОР ПРОДУКТА

- 1 Оголовье Ski Goggle*
- 2 Амбшюры Airweave*
- 3 Складной микрофон
- 4 Кнопка выключения микрофона
- 5 Регулировка громкости
- 6 Разъем Jack для мобильного кабеля
- 7 Разъем Share Jack для наушников
- 8 Зарядный кабель Jack USB-C
- 9 ChatMix Dial

- 10 Кнопка питания
- 11 Беспроводной ключ USB-C
- 12 Кабель-адаптер USB-C к USB-A
- 13 Зарядный кабель USB-C
- 14 4-полюсный аудио кабель 3,5 мм*

*Ищите аксессуары на сайте steelseries.com/gaming-accessories

УСТАНОВКА

БЕСПРОВОДНАЯ УСТАНОВКА

Подключение к USB-A

Подключение к USB-C

ПРОВОДНАЯ УСТАНОВКА

Более подробную информацию о продукте можно найти по адресу: steelseries.com/arctis-7x

ЗАРЯДКА

Для зарядки гарнитуры подключите зарядный кабель **13** к разъему USB-C Jack для зарядки **8** на гарнитуре, а другой конец вставьте в любой USB-источник питания.

Цвет кнопки питания **10** указывает на уровень заряда аккумулятора.

Зеленый	100-50 %	Желтый	49-20 %
Красный	19-10 %	Красный (быстро мигает)	9-1 %

ВКЛЮЧЕНИЕ/ВЫКЛЮЧЕНИЕ ПИТАНИЯ

Чтобы включить питание на гарнитуре, нажмите и удерживайте кнопку питания **10** в течение 1 секунды. Вы услышите сигнал, а кнопка питания **10** засветится.

Чтобы выключить гарнитуру, нажмите и удерживайте кнопку питания **10** в течение минимум 3 секунд.

СОПРЯЖЕНИЕ

Примечание: Гарнитура уже сопряжена с ключом из коробки. Для повторного сопряжения с ключом:

- 1 Подключите беспроводной ключ USB-C **11** к ПК с ОС Windows, на котором установлено SteelSeries GG.
- 2 Используйте зарядный кабель USB-C **12**, чтобы подключить гарнитуру к тому же ПК.
- 3 Используйте Engine из программного обеспечения SteelSeries GG, чтобы начать сопряжение.
- 4 Engine покажет, когда завершится сопряжение.

МИКРОФОН

СКЛАДНОЙ МИКРОФОН

РАСПОЛОЖЕНИЕ

Вид спереди

Вид сзади

Расположите микрофон ClearCast **3** близко к углу своего рта плоской поверхностью к себе.

УПРАВЛЕНИЕ МУЛЬТИМЕДИА

 Ответ/завершение голосового звонка одно · нажатие кнопки питания **10**

 Запуск/пауза музыки одно · нажатие кнопки питания **10**

 Следующий трек двойное · · нажатие кнопки питания **10**

 Предыдущий трек тройное · · · нажатие кнопки питания **10**

ОГОЛОВЬЕ SKI GOGGLE

Установка Направление установки оголовья.

Velcro Затяните или ослабьте ремни Velcro со стороны оголовья, чтобы получить необходимую посадку.

УСТАНОВКА CHATMIX

CHATMIX DIAL

Загрузите и установите SteelSeries GG, затем запустите первую установку аудио GG. После завершения установки ChatMix Dial **9** можно использовать для контроля баланса между уровнем громкости звука игры и чата их вашего приложения для голосового общения.

FRANÇAIS

CONTENU DE L'EMBALLAGE

Guide d'information sur le produit

Casque sans fil Arctis 7+

Dongle sans fil USB-C

Câble adaptateur USB-C vers USB-A

Câble audio 3,5 mm à 4 pôles

Câble de recharge USB-C

COMPATIBILITÉ SYSTÈME

PC, Mac, PlayStation 5, PlayStation 4, Nintendo Switch, Android (avec USB-C)

Trouvez de l'aide sur support.steelseries.com

APERÇU DU PRODUIT

- 1 Serre-tête pour lunettes de ski*
- 2 Coussinets Airweave pour les oreilles*
- 3 Microphone rétractable
- 4 Bouton de sourdine du microphone
- 5 Contrôle du volume
- 6 Prise pour câble mobile
- 7 Prise pour le partage des écouteurs
- 8 Prise de recharge USB-C
- 9 Roulette Chatmix
- 10 Bouton d'alimentation

11 Dongle sans fil USB-C

12 Câble adaptateur USB-C vers USB-A

13 Câble de recharge USB-C

14 Câble audio 3,5 mm à 4 pôles*

*Retrouvez les accessoires sur steelseries.com/gaming-accessories

CONFIGURATION

CONFIGURATION SANS FIL

Connexion à l'USB-A

Connexion à l'USB-C

CONFIGURATION FILAIRE

Plus d'informations détaillées sur le produit sur steelseries.com/arctis-7x

EN RECHARGE

Pour recharger le casque, connectez le câble de recharge USB-C **12** à la prise de recharge USB-C **8** du casque, et branchez l'autre extrémité à n'importe quelle source d'alimentation USB.

La couleur du bouton d'alimentation **10** indique le niveau de batterie.

Vert	100-50 %
jaune	49-20 %
rouge	19-10 %
rouge (clignotement rapide)	9-1 %

ALLUMER / ÉTEINDRE

Pour allumer le casque, appuyez sur le bouton d'alimentation **10** et maintenez-le enfoncé pendant 1 seconde. Vous entendrez une tonalité et le bouton d'alimentation **10** s'illuminera.

Pour éteindre le casque, appuyez sur le bouton d'alimentation **10** et maintenez-le enfoncé pendant 3 secondes.

APPAIRAGE

Remarque : Le casque est déjà appairé avec le dongle à la sortie de l'emballage. Pour réappairer le dongle :

- 1 Connectez le dongle sans fil USB-C **11** à un PC Windows sur lequel SteelSeries GG est installé.
- 2 Utilisez le **13** câble de recharge USB-C pour connecter le casque au même PC.
- 3 Utilisez Engine du logiciel SteelSeries GG pour initier l'appairage.
- 4 Engine indiquera lorsque l'appairage est terminé.

MICROPHONE

MICROPHONE RÉTRACTABLE

POSITIONNEMENT

vue de face

vue de dessus

Positionnez le microphone ClearCast **3** près du coin de votre bouche, la surface plane vous faisant face.

CONTRÔLE MULTIMÉDIA

 Répondre à/terminer un appel vocal · appuyer sur le bouton d'alimentation **10**

 Lecture/pause d'un titre musical · appuyer sur le bouton d'alimentation **10**

 Piste suivante double · · appuyer sur le bouton d'alimentation **10**

 Piste précédente triple · · · appuyer sur le bouton d'alimentation **10**

SERRE-TÊTE POUR LUNETTES DE SKI

Installer

Sens de placement du bandeau pour la tête.

Velcro

Serrez ou desserrez les bandes velcro sur le côté du bandeau pour la tête afin d'obtenir l'ajustement souhaité.

CONFIGURATION DU CHATMIX

ROULETTE CHATMIX

Téléchargez et installez SteelSeries GG, puis exécutez la première configuration audio de GG. Une fois la configuration terminée, la roulette ChatMix **9** peut être utilisée pour contrôler l'équilibre entre l'audio du jeu et l'audio du chat de votre application de communication vocale.

ITALIANO

CONTENUTO DELLA CONFEZIONE

Guida alle informazioni sul prodotto

Cuffie wireless Arctis 7+

Dongle wireless USB-C

Cavo adattatore da USB-C a USB-A

Cavo audio da 3,5 mm a 4 poli

Cavo di ricarica USB-C

COMPATIBILITÀ DEL SISTEMA

PC, Mac, PlayStation 5, PlayStation 4, Nintendo Switch, Android (con USB-C)

Trovi assistenza su support.steelseries.com

PANORAMICA SUL PRODOTTO

- 1 Fascia per maschera da sci*
- 2 Cuscinetti Airweave*
- 3 Microfono retraibile
- 4 Pulsante di mute del microfono
- 5 Controllo del volume
- 6 Cavo con jack per telefono
- 7 Jack per condivisione cuffie
- 8 Jack di ricarica USB-C
- 9 Manopola ChatMix

10 Pulsante di accensione

11 Dongle wireless USB-C

12 Cavo adattatore da USB-C a USB-A

13 Cavo di ricarica USB-C

14 Cavo audio da 3,5 mm a 4 poli*

*Trova gli accessori su steelseries.com/gaming-accessories

CONFIGURAZIONE

CONFIGURAZIONE WIRELESS

Connessione a USB-A

Connessione a USB-C

CONFIGURAZIONE CON CAVO

Informazioni più dettagliate sul prodotto su steelseries.com/setup/arctis-7x

RICARICA IN CORSO

Per caricare le cuffie, collegare il cavo di ricarica USB-C **12** al jack di ricarica USB-C **8** sull'auricolare e collegare l'altra estremità a qualsiasi fonte di alimentazione USB.

Il colore del pulsante di accensione **10** indica il livello della batteria.

Verde	100–50 %
Giallo	49–20 %
Rosso	19–10 %
Rosso (lampeggiante veloce)	9-1 %

ACCENSIONE/SPEGNIMENTO

Per accendere le cuffie, tieni premuto il pulsante di accensione **10** per 1 secondo. Sentirai un suono e il pulsante di accensione **10** si illuminerà.

Per spegnere le cuffie, tieni premuto il pulsante di accensione **10** per almeno 3 secondi.

ASSOCIAZIONE

Nota: Le cuffie sono già associate con il Dongle, non devi fare nulla. Per associare nuovamente il Dongle:

- 1 Collega il dongle wireless USB-C **11** su un PC Windows con SteelSeries GG installato.
- 2 Usa il **15** Cavo di ricarica USB-C per collegare le cuffie allo stesso PC.
- 3 Utilizza Engine che fa parte del software SteelSeries GG per avviare l'associazione.
- 4 Engine verrà visualizzato quando l'associazione è completata.

MICROFONO

MICROFONO RETRAIBILE

POSIZIONAMENTO





vista frontale

vista dall'alto

Posiziona il microfono ClearCast **9** vicino

all'angolo della bocca con la superficie piana rivolta verso di te.

CONTROLLO MULTIMEDIALE

-  Risposta/fine chiamata vocale
premi **·** una volta il pulsante di accensione **10**
-  Riproduci/metti in pausa la musica
premi **·** una volta il pulsante di accensione **10**
-  Brano successivo
premi **· ·** due volte il pulsante di accensione **10**
-  Traccia precedente
premi **· · ·** tre volte il pulsante di accensione **10**

FASCIA PER MASCHERA DA SCI

Installazione

Istruzioni per l'installazione della fascia.

Velcro

Stringere o allentare le cinghie in velcro sul lato della fascia per ottenere la vestibilità desiderata.

CONFIGURAZIONE DI CHATMIX

MANOPOLA CHATMIX

Scarica e installa SteelSeries GG, quindi esegui la prima configurazione audio di GG. Dopo aver terminato la configurazione, la manopola ChatMix **9**, può essere utilizzata per controllare il bilanciamento tra quanto vuoi sentire dell'audio del gioco rispetto all'audio della chat proveniente dalla tua applicazione di comunicazione vocale.

PORTUGUÊS

CONTEÚDO DA EMBALAGEM

Guia de informação sobre o produto

Auscultadores sem fios Arctis 7+

Dongle sem fios USB-C

Cabo adaptador USB-C para USB-A

Cabo de áudio de 3,5 mm de 4 polos

Cabo de carregamento USB-C

COMPATIBILIDADE

PC, Mac, PlayStation 5, PlayStation 4, Nintendo Switch, Android (com USB-C)

Obtém ajuda em support.steelseries.com

DESCRIÇÃO GERAL DO PRODUTO

- 1 Arco de suporte de óculos de esqui*
- 2 Almofadas AirWeave*
- 3 Microfone retrátil
- 4 Botão de silêncio do microfone
- 5 Controlo de volume
- 6 Conector de cabo para telemóvel
- 7 Conector de partilha de auscultadores
- 8 Conector de carregamento USB-C
- 9 ChatMix Dial
- 10 Botão de energia

11 Dongle sem fios USB-C

12 Cabo adaptador USB-C para USB-A

13 Cabo de carregamento USB-C

14 Cabo de áudio de 3,5 mm de 4 polos*

*Encontra acessórios em steelseries.com/gaming-accessories

CONFIGURAÇÃO

CONFIGURAÇÃO SEM FIOS

Ligação a USB-A

Ligação a USB-C

CONFIGURAÇÃO COM FIOS

Mais informações detalhadas em steelseries.com/arctis-7x

CARREGAMENTO

Para carregar os auscultadores, liga o cabo de carregamento USB-C **13** ao conector de carregamento USB-C **8** nos auscultadores e liga a outra extremidade a qualquer fonte de alimentação USB.

A cor do botão de energia **10** indica o nível da bateria.

Verde	100–50 %
Amarelo	49–20 %
Vermelho	19–10 %
Vermelho (intermitente rápido)	9–1 %

LIGAR/DESLIGAR

Para ligar os auscultadores, mantém o botão de energia **10** premido durante 1 segundo. Será emitido um som e o botão de energia **10** ficará iluminado.

Para desligar os auscultadores, mantém o botão de energia **10** premido pelo menos 3 segundos.

EMPARELHAMENTO

Nota: Os auscultadores já se encontram emparelhados com o dongle, de fábrica. Para emparelhar novamente com o dongle:

- 1 Liga o dongle sem fios USB-C **11** a um PC Windows com o SteelSeries GG instalado.
- 2 Utiliza o **13** cabo de carregamento USB-C para ligar os auscultadores ao mesmo PC.
- 3 Utiliza o Engine do software SteelSeries GG para iniciar o emparelhamento.
- 4 O Engine irá indicar quando o emparelhamento estiver concluído.

MICROFONE

MICROFONE RETRÁTIL

POSICIONAMENTO

Vista frontal

Vista superior

Posiciona o microfone ClearCast **9** perto do canto da boca com a superfície plana voltada para ti.

CONTROLO MULTIMÉDIA

 Responder/terminar chamada de voz prime · uma vez o botão de energia **10**

 Reproduzir/pausar música prime · uma vez o botão de energia **10**

 Faixa seguinte prime ·· duas vezes o botão de energia **10**

 Faixa anterior prime ··· três vezes o botão de energia **10**

ARCO DE SUPORTE DE ÓCULOS DE ESQUI

Instalação
Direção da instalação do arco de suporte.

Velcro
Aperta ou afrouxa as tiras de Velcro na lateral do arco de suporte para alcançar o ajuste pretendido.

CONFIGURAÇÃO DE CHATMIX

CHATMIX DIAL

Transfere e instala o SteelSeries GG e executa a configuração de áudio inicial do GG. Depois de terminar a configuração, o ChatMix Dial **9** pode ser utilizado para controlar o equilíbrio entre o volume do áudio do jogo e do áudio do chat da sua aplicação de comunicação de voz.

POLSKI

ZAWARTOŚĆ OPAKOWANIA

Przewodnik dotyczący informacji o produkcie

Bezprzewodowy zestaw słuchawkowy Arctis 7+

Bezprzewodowy odbiornik USB-C

Przewód-adapter USB-C – USB-A

4-biegunowy przewód audio 3,5 mm

Przewód ładujący USB-C

KOMPATYBILNOŚĆ Z SYSTEMAMI

PC, Mac, PlayStation 5, PlayStation 4, Nintendo Switch, Android (z USB-C)

Pomoc dostępna na stronie support.steelseries.com

OPIS PRODUKTU

- 1 Pasek do regulacji pałąka*
- 2 Poduszki nauszne Airweave*
- 3 Wysuwany mikrofon
- 4 Przycisk wyciszenia mikrofonu
- 5 Regulator głośności
- 6 Złącze typu jack na kabel do telefonu
- 7 Złącze typu jack do podłączenia innych słuchawek
- 8 Złącze ładowania USB-C
- 9 Regulator ChatMix
- 10 Przycisk zasilania

11 Bezprzewodowy odbiornik USB-C

12 Przewód-adapter USB-C – USB-A

13 Przewód ładujący USB-C

14 4-biegunowy przewód audio 3,5 mm*

*Akcesoria dostępne na stronie steelseries.com/gaming-accessories

KONFIGURACJA

KONFIGURACJA BEZPRZEWODOWA

Podłączenie do USB-A

Podłączenie do USB-C

KONFIGURACJA PRZEWODOWA

Szczegółowe informacje na temat produktu dostępne są na stronie steelseries.com/arctis-7x

ŁADOWANIE

Aby naładować zestaw słuchawkowy, podłącz przewód ładujący USB-C **13** do złącza USB-C **8**, znajdującego się na zestawie, a następnie podłącz drugi koniec do dowolnego źródła zasilania USB.

Kolor przycisku zasilania **10** wskazuje poziom naładowania baterii.

Zielony	100-50%
Żółty	49-20%
Czerwony	19-10%
Czerwony (szybko migający)	9-1%

WŁĄCZANIE/WYŁĄCZANIE

Aby włączyć zestaw słuchawkowy, naciśnij

i przytrzymaj przycisk zasilania **10** przez przynajmniej 1 sekundę. Usłyszysz sygnał, a przycisk zasilania **10** zaświeci się.

Aby wyłączyć zestaw słuchawkowy, naciśnij i przytrzymaj przycisk zasilania **10** przez przynajmniej 3 sekundy.

PAROWANIE

Uwaga: Zestaw słuchawkowy został już w pełni sparowany z odbiornikiem. Aby ponownie sparować odbiornik:

- 1 Podłącz bezprzewodowy odbiornik USB-C **11** do komputera z systemem Windows z zainstalowanym oprogramowaniem SteelSeries GG
- 2 Użyj **13** przewodu ładującego USB-C, aby podłączyć zestaw słuchawkowy do tego samego komputera.
- 3 Użyj aplikacji Engine z platformy SteelSeries GG, aby rozpocząć parowanie.
- 4 Aplikacja Engine wskaże, gdy parowanie zostanie zakończone.

MIKROFON

WYSUWANY MIKROFON





POZYCJONOWANIE

widok z przodu

widok z góry

Umieść mikrofon ClearCast **3** blisko kącika ust, płaska powierzchnia powinna być skierowana w Twoją stronę.

STEROWANIE MULTIMEDIAMI

-  Odbierz/zakończ połączenie głosowe jedno · naciśnięcie przycisku zasilania **10**
-  Odtwórz/zatrzymaj muzykę jedno · naciśnięcie przycisku zasilania **10**
-  Następny utwór dwa · · naciśnięcia przycisku zasilania **10**
-  Poprzedni utwór trzy · · · naciśnięcia przycisku zasilania **10**

PASEK DO REGULACJI PAŁĄKA

Dopasowywanie
Kierunek dopasowywania paska.

Rzep
Zaciągnij lub poluzuj zapinane na rzep elementy paska znajdujące się po bokach pałąka, by uzyskać idealne dopasowanie

KONFIGURACJA CHATMIX

REGULATOR CHATMIX

Pobierz i zainstaluj SteelSeries GG, a następnie uruchom w GG wstępną konfigurację audio. Po zakończeniu konfiguracji regulator ChatMix **9** może być używany do balansowania dźwięku pomiędzy grą a czatem głosowym w wybranym komunikatorze.

REGULATORY



Europe – EU Declaration of Conformity

Hereby, SteelSeries ApS. declares that the equipment which is compliance with directive RoHS 2.0 (2015/863/EU), R.E.D (2014/53/EU), EMC Directive (2014/30/EU), and LVD (2014/35/EU) which are issued by the Commission of the European Community.

The full text of the EU declaration of conformity is available at the following internet address: <https://steelseries.com/>

Operating Temperature: 0 to + 40 °C

SteelSeries ApS. hereby confirms, to date, based on the feedback from our suppliers indicates that our products shipping to the EU territory comply with REACH (Registration, Evaluation, Authorization, and Restriction of Chemicals - (EC) 1907/2006) compliance program. We are fully committed to offering REACH compliance on the products and posting accurate REACH compliance status for the all of products.

Frequency bands and Powers (Headset and Transceiver)

a. Frequency band(s) in which the radio equipment operates: 2.400 - 2.4835 GHz

b. Maximum radio-frequency power transmitted in the frequency band(s) in which the radio equipment operates:

-EIRP: μ /4-DQPSK: 7.78 dBm (Headset ANT 1)

-EIRP: μ /4-DQPSK: 9.57 dBm (Headset ANT 2)

-EIRP: μ /4-DQPSK: 9.32 dBm (Transceiver)

c. Firmware Version: T1.00.05



UK Declaration of Conformity

Hereby, SteelSeries ApS. declares that the following equipment which is compliance with Electromagnetic Compatibility Regulations 2016, Electrical Equipment (Safety) Regulations 2016, Radio Equipment Regulations 2017 and The Restriction of the Use of Certain Hazardous Substances in Electrical and Electronic Equipment Regulations 2012 issued by the Department for Business, Energy& Industrial Strategy.

The full text of the UK declaration of conformity is available at the following internet address: <https://steelseries.com/>

WEEE

This product must not be disposed of with your other household waste or treat them in compliance with the local regulations or contact your local city office, your household waste disposal service or the shop where you purchased the product.

TURKEY ROHS COMPLIANCE

Republic of Turkey: In conformity with the EEE Regulation

Türkiye Cumhuriyeti: EEE Yönetmeliğine Uygundur

Safety Guideline for Lithium Battery

This battery must not be disposed of with your other household waste or treat them in compliance with the local regulations or contact your local city office, your household waste disposal service or the shop where you purchased the product.



Federal Communication Commission Interference Statement

This device complies with Part 15 of the FCC Rules. Operation is subject to the following two conditions: (1) This device may not cause harmful interference, and (2) this device must accept any interference received, including interference that may cause undesired operation.

This equipment has been tested and found to comply with the limits for a Class B digital device, pursuant to Part 15 of the FCC Rules. These limits are designed to provide reasonable protection against harmful interference in a residential installation. This equipment generates, uses and can radiate radio frequency energy and, if not installed and used in accordance with the instructions, may cause harmful interference to radio communications. However, there is no guarantee that interference will not occur in a particular installation. If this equipment does cause harmful interference to radio or television reception, which can be determined by turning the equipment off and on, the user is encouraged to try to correct the interference by one of the following measures:

- Reorient or relocate the receiving antenna.
- Increase the separation between the equipment and receiver.
- Connect the equipment into an outlet on a circuit different from that to which the receiver is connected.
- Consult the dealer or an experienced radio/TV technician for help.

FCC Caution:

Any changes or modifications not expressly approved by the party responsible for compliance could void the user's authority to operate this equipment.

This transmitter must not be co-located or operating in conjunction with any other antenna or transmitter.

Radiation Exposure Statement:

The device has been evaluated to meet general RF exposure requirement, the device can be used in portable exposure condition without restriction.

FCC ID: ZHK-HS33 (Wireless Headset)

FCC ID: ZHK-HS33TX(Transceiver)

Frequency bands and Powers (Mouse and Transceiver)

a. Frequency band(s) in which the radio equipment operates: 2.400 - 2.4835 GHz

b. Maximum radio-frequency power transmitted in the frequency band(s) in which the radio equipment operates:

- Conducted Peak Power/ μ /4-DQPSK: 4.88 dBm (Headset ANT 1)

- Conducted Peak Power/ μ /4-DQPSK: 4.9 dBm (Headset ANT 2)

- Conducted Peak Power/ μ /4-DQPSK: 5.45 dBm (Transceiver)

c. Firmware Version: T1.00.05

Regions	Contact Information
USA	SteelSeries ApS., 656 W Randolph St., Suite 3E, Chicago, IL 60661, USA +1 312 258 9467

More information and support from <https://steelseries.com/>

Industry Canada Statement:

This device complies with Industry Canada license-exempt RSS standard(s). Operation is subject to the following two conditions:

- 1) this device may not cause interference, and
 - 2) this device must accept any interference, including interference that may cause undesired operation of the device.
- Le présent appareil est conforme aux CNR d'Industrie Canada applicables aux appareils radio exempts de licence. L'exploitation est autorisée aux deux conditions suivantes:
- 1) l'appareil ne doit pas produire de brouillage, et
 - 2) l'utilisateur de l'appareil doit accepter tout brouillage radioélectrique subi, même si le brouillage est susceptible d'en compromettre le fonctionnement.

This Class B digital apparatus complies with Canadian ICES-003.

Cet appareil numérique de la classe B est conforme à la norme NMB-003 du Canada.

This device and its antenna(s) must not be co-located or operating in conjunction with any other antenna or transmitter, except tested built-in radios.

Cet appareil et son antenne ne doivent pas être situés ou fonctionner en conjonction avec une autre antenne ou un autre émetteur, exception faites des radios intégrées qui ont été testées.

The County Code Selection feature is disabled for products marketed in the US/ Canada.

La fonction de sélection de l'indicatif du pays est désactivée pour les produits commercialisés aux États-Unis et au Canada.

The appliance must not be exposed to splashes or drops of water and it should not be used as a support for any object filled with liquid, such as a vase.

L'appareil ne doit pas être exposé à des éclaboussures ou à des gouttes d'eau et il ne doit pas servir de support à un quelconque objet rempli de liquide, tel qu'un vase.

"CAUTION!"

RISK OF EXPLOSION IF BATTERY PACK IS NOT REPLACE BY SAME TYPE AS SPECIFIED BY THE MANUFACTURER.

Please keep follow all listed important warnings and cautions below while using this battery pack to avoid any damage or hazard.

1. The battery polarity (+) and (-) shall not be connected and charged reversely. Risk of explosion if the battery polarity (+) and (-) is reversed.
2. Please keep this battery pack away from fire and high heat sources due to the explosion that might happen. Do not place your battery pack close to any heater or hot location.
3. This battery pack shall not be hit or impacted. This battery pack shall not be dealt with any sharp or keen objects either.
4. This battery pack shall not be exposed to moisture, dripping or splashing.
5. If any electrolyte flows out of this battery pack when touching the user's eyes and skin, please seek medical advice immediately.

"MISE EN GARDE!"

RISQUE D'EXPLOSION SI LE BLOC-PILES N'EST PAS REMPLACÉ PAR LE MÊME TYPE QUE SPÉCIFIÉ PAR LE FABRICANT.

Veillez suivre tous les avertissements et mises en garde ci-dessous lors de l'utilisation de cette batterie pour éviter tout dommage ou danger.

1. La polarité (+) et (-) de la batterie ne doit pas être connectée et chargée à l'envers. Risque d'explosion si la polarité (+) et (-) de la batterie est inversée.
2. Gardez cette batterie à l'écart du feu et des sources de chaleur élevées en raison de l'explosion qui pourrait se produire. Ne placez pas votre batterie près d'un radiateur ou d'un endroit chaud.
3. Cette batterie ne doit pas être heurtée ni impactée. Ce bloc-batterie ne doit pas non plus être traité avec des objets tranchants ou vifs.
4. Cette batterie ne doit pas être exposée à l'humidité, aux gouttes ou aux éclaboussures.
5. Si un électrolyte s'écoule de cette batterie lorsque vous touchez les yeux et la peau de l'utilisateur, consultez immédiatement un médecin.

Radiation Exposure Statement:

The device has been evaluated to meet general RF exposure requirement, The device can be used in portable exposure condition without restriction.

Déclaration d'exposition aux radiations:

L'appareil a été évalué pour répondre aux exigences générales d'exposition aux radio fréquences.

L'appareil peut être utilisé en condition d'exposition portable sans restriction

Headset IC: 9638A-HS33

Transceiver IC: 9638A-HS33TX

해당 무선설비는 운용 중 전파혼신 가능성이 있음

해당 무선설비는 전파혼신 가능성이 있으므로 인명안전과 관련된 서비스는 할 수 없음

이 기기는 가정용(B급) 전자파적합기기로서 주로 가정에서 사용하는 것을 목적으로 하며, 모든 지역에서 사용할 수 있습니다



- | | |
|-------------|--------------------------------|
| 1. 상호명: | SteelSeries ApS. |
| 2. 기기명칭: | Wireless Headset / Transceiver |
| 3. 모델명: | HS33 / HS33TX |
| 4. 인증번호: | R-R-SS4-HS33
R-R-SS4-HS33TX |
| 5. 제조사/제조국: | SteelSeries ApS./China |



この装置は、クラスB機器です。この装置は、住宅環境で使用することを目的としていますが、この装置がラジオやテレビジョン受信機に近接して使用されると、受信障害を引き起こすことがあります。取扱説明書に従って正しい取り扱いをして下さい。VCCI-B

この機器の使用周波数帯では、電子レンジ等の産業・科学・医療用機器のほか工場の製造ライン等で使用されている移動体識別用の構内無線局（免許を要する無線局）及び特定小電力無線局（免許を要しない無線局）並びにアマチュア無線局（免許を要する無線局）が運用されています。

- 1 この機器を使用する前に、近くで移動体識別用の構内無線局及び特定小電力無線局並びにアマチュア無線局が運用されていないことを確認して下さい。
- 2 万一、この機器から移動体識別用の構内無線局に対して有害な電波干渉の事例が発生した場合には、速やかに使用周波数を変更するか又は電波の発射を停止した上、下記連絡先にご連絡頂き、混信回避のための処置等（例えば、パーティションの設置など）についてご相談して下さい。
- 3 その他、この機器から移動体識別用の特定小電力無線局あるいはアマチュア無線局に対して有害な電波干渉の事例が発生した場合など何かお困りのことが起きたときは、次の連絡先へお問い合わせ下さい。

低功率電波輻射性電機管理辦法

取得審驗證明之低功率射頻器材，非經核准，公司、商號或使用者均不得擅自變更頻率、加大功率或變更原設計之特性及功能。低功率射頻器材之使用不得影響飛航安全及干擾合法通信；經發現有干擾現象時，應立即停用，並改善至無干擾時方得繼續使用。前述合法通信，指依電信管理法規定作業之無線電通信。低功率射頻器材須忍受合法通信或工業、科學及醫療用電波輻射性電機設備之干擾。

鋰電池安全使用指南

注意：電池若未正確更換，可能會爆炸，請用原廠建議之同款的電池來更換。

電池不可當作一般的家庭廢棄物棄置，請依據當地法規使用公共回收系統退回、回收或處理電池。

電池極性 (+) 和 (-) 不得相反連接，充電電池極性如果電池極性反轉，則有爆炸危險。

請勿將此電池放在靠近火源或任何高溫的地方，否則可能會因高熱源而發生爆炸(60°C以上)。

電池組不得受撞擊，也不能用任何尖銳的物體去穿刺。

該電池組無防水功能，不得暴露於潮濕場所避免受潮導致兩電池極性短路導致爆炸危險。

電池若是膨脹請勿繼續使用

*報廢電池請按照廢棄物管理辦法回收處理

《废弃电器电子产品回收处理管理条例》提示性说明

为了更好地关爱及保护地球，当用户不再需要此产品或产品寿命终止时，请遵守国家废弃电器电子产品回收处理相关法律法规，将其交给当地具有国家认可的回收处理资质的厂商进行回收处理。

產品使用環境溫度：0 - 40度

SteelSeries Products and Australian Consumer Law

Our goods come with guarantees that cannot be excluded under Australian consumer law. You are entitled to a repair, replacement, or refund for a major failure and compensation for any other reasonably foreseeable loss or damage. You are also entitled to have the goods repaired or replaced if the goods fail to be of acceptable quality and the failure does not amount to a major failure.

Should your product be defective, you can make a claim under Australian consumer law.

SteelSeries will provide its own remedies equivalent to those remedies in the consumer guarantee provisions of the Australian Consumer Law at any time within 24 months of the date of purchase. For the avoidance of doubt, SteelSeries acknowledges that the Australian Consumer Law may provide for remedies beyond 24 months for a number of its products.

Summary of Australian statutory consumer guarantees

Consumer guarantees in relation to goods

The goods will be of acceptable quality, The goods will be fit for a particular purpose, The goods will match their description, The goods will match the sample or demonstration model, You have title to the goods, You have undisturbed possession of the goods, There are no undisclosed securities on the goods.

Consumer guarantees in relation to services

We will provide the services with due care and skill, The services will be fit for a particular purpose, The services will be provided within a reasonable time.

For SteelSeries-branded goods, in addition to the above, we also guarantee that we will provide repairs or spare parts for a reasonable time. Under Australian consumer law, the remedy you are entitled to if a product fails to meet a consumer guarantee will depend on whether the failure to comply with the guarantee is major or minor.

Minor failures to comply with a consumer guarantee can normally be fixed or resolved in a reasonable amount of time. In this case, the seller can choose to offer you a refund, replacement, repair or, in the case of services, resupply. If the seller does not fix the problem or takes too long, you may be able to get it fixed by someone else and recover the costs from the seller depending on the circumstances.

Remedies for major failure with goods

Return the product and ask for a refund, Return the product and ask for an identical replacement, or one of similar value if reasonably available, Keep the product and ask for compensation for the drop in value caused by the problem.

Remedies for major failure with services

Cancel the contract and pay a reasonable amount for the work done, or seek a refund, For money already paid, keep the contract and negotiate a reduced price for the drop in value of the service — this may mean asking for some of your money back if you have already paid.

For goods, there is a major failure to comply with a consumer guarantee when:

- You would not have purchased the product if you had known about the problem.
- The product is significantly different from the description, sample or demonstration model you were shown.
- The product is substantially unfit for its normal purpose and cannot easily be made fit within a reasonable time.
- The product is substantially unfit for a purpose that you told the supplier about, and cannot easily be made fit



廢電池請回收

within a reasonable time.

• The product is unsafe.

For services, there is a major failure to comply with a consumer guarantee when:

• You would not have engaged the service if you had known the nature and extent of the problem.

• The service does not meet the reasonable expectations for that type of service, and the problem cannot be rectified within a reasonable time.

• You told the supplier that you wanted the service for a specific purpose, which was not fulfilled, and the problem could not be easily rectified within a reasonable time.

• You told the supplier that you wanted a specific result, yet the service and end result failed to meet your specifications and could not be easily rectified within a reasonable time.

• The supply of the service has created an unsafe situation.

For information on Australian consumer laws, please visit Australian consumer law website at

<http://www.consumerlaw.gov.au>.

Importer Name and Address: Ingram Micro Pty LTD / Level1, 61 Dunning Avenue, Rosebery NSW 2018

Telephone technical support: +61-2-9381-6000

This product is compliant with requirements of Circular No. 30/2011/TT-BCT Regulations "STIPULATING TEMPORARILY THE PERMISSIBLE CONTENT LIMITATION OF SOME TOXIC CHEMICALS IN THE ELECTRONIC, ELECTRICAL PRODUCTS"

Restriction on Hazardous Substances statement (India)

This product complies with the "India E-waste Rule 2011" and prohibits use of lead, mercury, hexavalent chromium, polybrominated biphenyls or polybrominated diphenyl ethers in concentrations exceeding 0.1 weight % and 0.01 weight % for cadmium, except for the exemptions set in Schedule 2 of the Rule.

微功率设备应当在其产品使用说明:

(一)符合“微功率短距离无线电发射设备目录和技术要求”的具体条款和使用场景,采用的天线类型和性能,控制、调整及开关等使用方法;

(二)不得擅自改变使用场景或使用条件、扩大发射频率范围、加大发射功率(包括额外加装射频功率放大器),不得擅自更改发射天线;

(三)不得对其他合法的无线电台(站)产生有害干扰,也不得提出免受有害干扰保护;

(四)应当承受辐射射频能量的工业、科学及医疗(ISM)应用设备的干扰或其他合法的无线电台(站)干扰;

(五)如对其他合法的无线电台(站)产生有害干扰时,应立即停止使用,并采取措施消除干扰后方可继续使用;

(六)在航空器内和依据法律法规、国家有关规定、标准划设的射电天文台、气象雷达站、卫星地球站(含测控、测距、接收、导航站)等军民用无线电台(站)、机场等的电磁环境保护区域内使用微功率设备,应当遵守电磁环境保护及相关行业主管部门的规定;

(七)禁止在以机场跑道中心点为圆心、半径5000米的区域内使用各类模型遥控器;

(八)微功率设备使用时温度和电压的环境条件。



《废弃电器电子产品回收处理管理条例》提示性说明

为了更好地关爱及保护地球,当用户不再需要此产品或产品寿命终止时,请遵守国家废弃电器电子产品回收处理相关法律法规,将其交给当地具有国家认可的回收处理资质的厂商进行回收处理。

锂电池安全使用指南

注意:电池若未正确更换,可能会爆炸,请用原厂建议之同款的电池来更换。

电池不可当作一般的家庭废弃物弃置,请依据当地法规使用公共回收系统退回、回收或处理电池。

1. 电池极性(+)和(-)不得相反连接,充电电池极性如果电池极性反转,则有爆炸危险。

2. 请勿将此电池放在靠近火源或任何高温的地方,否则可能会因高热而发生爆炸。

3. 电池组不得受撞击,也不能用任何尖锐的物体去穿刺。

4. 该电池组无防水功能,不得暴露于潮湿场所避免受潮导致两电极短路导致爆炸危险。

5. 电池若是膨胀请勿继续使用

微功率设备产品使用说明:

(一)符合“微功率短距离无线电发射设备目录和技术要求”的具体条款和使用场景,采用的天线类型和性能,控制、调整及开关等使用方法;

(二)不得擅自改变使用场景或使用条件、扩大发射频率范围、加大发射功率(包括额外加装射频功率放大器),不得擅自更改发射天线;

(三)不得对其他合法的无线电台(站)产生有害干扰,也不得提出免受有害干扰保护;

(四)应当承受辐射射频能量的工业、科学及医疗(ISM)应用设备的干扰或其他合法的无线电台(站)干扰;

(五)如对其他合法的无线电台(站)产生有害干扰时,应立即停止使用,并采取措施消除干扰后方可继续使用;

(六)在航空器内和依据法律法规、国家有关规定、标准划设的射电天文台、气象雷达站、卫星地球站(含测控、测距、接收、导航站)等军民用无线电台(站)、机场等的电磁环境保护区域内使用微功率设备,应当遵守电磁环境保护及相关行业主管部门的规定;

(七)禁止在以机场跑道中心点为圆心、半径5000米的区域内使用各类模型遥控器;

(八)微功率设备使用时温度和电压的环境条件。

Ukraine RoHS:

Обладнання відповідає вимогам Технічного регламенту щодо обмеження використання деяких небезпечних речовин в електричному та електронному обладнанні, затвердженого постановою Кабінету Міністрів України від 3 грудня 2008 № 1057

根据中国大陆《电子电气产品有害物质限制使用标识要求》，以下部分列出了产品中可能包含的有害物质的名称和含量：						
零部件名称	有害物质					
	铅 (Pb)	汞 (Hg)	镉 (Cd)	六价铬 (Cr(VI))	多溴联苯 (PBB)	多溴二苯醚 (PBDE)
电路板组件	X	○	○	○	○	○
其他线材	X	○	○	○	○	○

*: 电路板组件包括印刷电路板及其构成的零部件，如电阻、电容、集成电路、连接器等。

本表格依据SJ/T 11364的规定编制。

O: 表示该有害物质在该部件所有均质材料中的含量均在 GB/T 26572规定的限量要求以下。

X: 表示该有害物质至少在该部件的某一均质材料中的含量超出GB/T 26572规定的限量要求；

上表中打“X”的部件，应功能需要，部分有害物质含量超出GB/T 26572规定的限量要求，但是符合欧盟RoHS法规要求(属于豁免部分)。

The RoHS test method is based on the standards JIS C 0950 and CNS 15663.

設備名稱: 無線耳機 Equipment name: Wireless Headset		型號(型式): HS33 Type designation: HS33				
單元 / Unit	限用物質及其化學符號 Restricted substances and its chemical symbols					
	鉛 Lead (Pb)	汞 Mercury (Hg)	鎘 Cadmium (Cd)	六價鉻 Hexavalent chromium (Cr+6)	多溴聯苯 Polybrominated biphenyls (PBB)	多溴二苯醚 Polybrominated diphenyl ethers (PBDE)
塑膠部件 / Plastic	○	○	○	○	○	○
電路板及元件 / PCBA	-	○	○	○	○	○
線材 / Cables	-	○	○	○	○	○
金屬部件 / Metal	-	○	○	○	○	○

備考1. “超出0.1 wt %”及“超出0.01 wt %”係指限用物質之百分比含量超出百分比含量基準值。
Note 1: “Exceeding 0.1 wt %” and “exceeding 0.01 wt %” indicate that the percentage content of the restricted substance exceeds the reference percentage value of presence condition.

備考2. ○係指該項限用物質之百分比含量未超出百分比含量基準值。
Note 2: ○ Indicates that the percentage content of the restricted substance does not exceed the percentage of reference value of presence.

備考3. - 係指該項限用物質為排除項目。
Note 3: - indicates that the restricted substance corresponds to the exemption



Custom Union Compliance.
(Russia / Belarus / Kazakhstan /
Armenia / Kyrgyzstan)



Malaysia Approval (SIRIM)



ACMA Compliance
(Australia/ New Zealand)



RED (2014/53/EU),
EMCD(2014/30/EU) and LVD
(2014/35/EU) Compliances (The
Commission of the European
Community.)



Direct Current



Singapore approval (IMDA)

Product Name (產品名稱/产品名称): Wireless Headset (無線耳機/无线耳机)
Model No. (型號/型号): HS33
Rated (規格/规格): 5V  500mA
Made in China 中國製造/中国制造
Operating Temperature: 0 to + 40 °C

Accessories information (配件資訊/配件信息)

Product Name: (產品名稱/产品名称): Transceiver (收發器/收发器)
Model No. (型號/型号): HS33TX
Rated (規格/规格): 5V  100mA

Regions	Contact Information	
亞洲	丹麥商賽睿有限公司台灣分公司 23511 新北市中和區建一路150號16樓	+886 2 8226 3858
Asia	SteelSeries ApS. Taiwan Branch 16F, No.150, Jian-Yi Rd., Chung Ho Dist., New Taipei City, Taiwan (R.O.C)	+886 2 8226 3858
USA	656 W Randolph St, Suite 3E, Chicago, IL 60661, USA	+1 312 258 9467
Europe	Havneholmen 8, 1.Sal, 2450 Copenhagen SV, Denmark	+45 7025 0075

More information and support from <https://steelseries.com/>



learn more at steelseries.com