



CE EMC TEST REPORT

On Behalf of

Linhai Dongle Lighting Co., Ltd.

Product Name: Neon Lights Modelling

Trademark: N/A

Model Number: Desktop Modeling, Hanging type modelling, Alphabetic modeling, Digital modeling.

Prepared For: Linhai Dongle Lighting Co., Ltd.

Address: 5-22, San Jia East Road, Dongcheng Town, Linhai City, Zhe Jiang Province.

Prepared By: Shenzhen BKC Testing Co., Ltd.

Address: 6/F, Building 3, Zhouteng Industrial Park, Nanwan Street, Longgang District, Shenzhen, Guangdong, China.

Report No.: BKC-180801366R



TABLE OF CONTENT

	Page
Test Report Declaration	
1. GENERAL INFORMATION	5
1.1. Description of Device (EUT)	5
1.2. Tested System Details	5
1.3. Test Uncertainty	5
1.4. Test Facility	6
2. TEST INSTRUMENT USED	7
3. CONDUCTED EMISSION AT THE MAINS TERMINALS TEST	9
3.1. Block Diagram Of Test Setup	9
3.2. Test Standard	9
3.3. Power Line Conducted Emission Limit	9
3.4. EUT Configuration on Test	9
3.5. Operating Condition of EUT	9
3.6. Test Procedure	10
3.7. Test Result	10
4. MAGNETIC EMISSION TEST	11
4.1. Block Diagram Of Test Setup	11
4.2. Test Standard	11
4.3. Power Line Conducted Emission Limit	11
4.4. EUT Configuration on Test	11
4.5. Operating Condition of EUT	11
4.6. Test Procedure	12
4.7. Test Result	12
5. RADIATION EMISSION TEST	16
5.1. Block Diagram of Test Setup	16
5.2. Test Standard	16
5.3. Radiation Limit	16
5.4. EUT Configuration on Test	16
5.5. Operating Condition of EUT	17
5.6. Test Procedure	17
5.7. Test Result	17
6. HARMONIC CURRENT EMISSION TEST	20
6.1. Block Diagram of Test Setup	20
6.2. Test Standard	20
6.3. Operating Condition of EUT	20
6.4. Test Procedure	20
6.5. Test Results	20
7. VOLTAGE FLUCTUATIONS & FLICKER TEST	21
7.1. Block Diagram of Test Setup	21
7.2. Test Standard	21
7.3. Operating Condition of EUT	21
7.4. Test Procedure	21
7.5. Test Results	21
8. ELECTROSTATIC DISCHARGE IMMUNITY TEST	22
8.1. Block Diagram of Test Setup	22
8.2. Test Standard	22
8.3. Severity Levels and Performance Criterion	22
8.4. EUT Configuration	23
8.5. Operating Condition of EUT	23



8.6. Test Procedure..... 23

8.7. Test Results.....24

9. RF FIELD STRENGTH SUSCEPTIBILITY TEST..... 25

9.1. Block Diagram of Test Setup.....25

9.2. Test Standard.....25

9.3. Severity Levels and Performance Criterion.....26

9.4. EUT Configuration on Test..... 26

9.5. Operating Condition of EUT..... 26

9.6. Test Procedure..... 27

9.7. Test Results.....27

10. ELECTRICAL FAST TRANSIENT/BURST IMMUNITY TEST..... 28

10.1. Block Diagram of EUT Test Setup..... 28

10.2. Test Standard..... 28

10.3. Severity Levels and Performance Criterion.....28

10.4. EUT Configuration on Test..... 29

10.5. Operating Condition of EUT.....29

10.6. Test Procedure..... 29

10.7. Test Results..... 29

11. SURGE TEST.....30

11.1. Block Diagram of EUT Test Setup.....30

11.2. Test Standard.....30

11.3. Severity Levels and Performance Criterion.....30

11.4. EUT Configuration on Test..... 31

11.5. Operating Condition of EUT..... 31

11.6. Test Procedure.....31

11.7. Test Result.....31

12. INJECTED CURRENTS SUSCEPTIBILITY TEST..... 32

12.1. Block Diagram of EUT Test Setup..... 32

12.2. Test Standard..... 32

12.3. Severity Levels and Performance Criterion.....32

12.4. EUT Configuration on Test..... 33

12.5. Operating Condition of EUT.....33

12.6. Test Procedure..... 33

12.7. Test Result..... 34

13. MAGNETIC FIELD IMMUNITY TEST..... 35

13.1. Block Diagram of Test Setup..... 35

13.2. Test Standard..... 35

13.3. Severity Levels and Performance Criterion.....35

13.4. EUT Configuration on Test..... 36

13.5. Operating Condition of EUT.....36

13.6. Test Procedure..... 36

13.7. Test Results..... 36

14. VOLTAGE DIPS AND INTERRUPTIONS TEST.....37

14.1. Block Diagram of EUT Test Setup..... 37

14.2. Test Standard..... 37

14.3. Severity Levels and Performance Criterion.....37

14.4. EUT Configuration on Test..... 38

14.5. Operating Condition of EUT.....38

14.6. Test Procedure..... 38

14.7. Test Result..... 38

15. EUT PHOTOGRAPHS.....39



Shenzhen BKC Testing Co., Ltd.

Applicant : Linhai Dongle Lighting Co., Ltd.
Address : 5-22, San Jia East Road, Dongcheng Town, Linhai City, Zhe Jiang Province.
Manufacturer : Linhai Dongle Lighting Co., Ltd.
Address : 5-22, San Jia East Road, Dongcheng Town, Linhai City, Zhe Jiang Province.
EUT : Neon Lights Modelling
Model Number : Desktop Modeling
Trademark: : N/A
Test Date : Aug. 14, 2018 - Aug. 22, 2018
Date of Report : Aug. 22, 2018
Test Result: : The equipment under test was found to be compliance with the requirements of the standards applied.

Test Procedure Used:

EMI : EN 55015: 2013+A1:2015
EN 61000-3-2:2014, EN 61000-3-3:2013
EMS : EN 61547:2009
EN 61000-4-2:2009, EN 61000-4-3:2006+A1:2008+A2:2010,
EN 61000-4-4:2012, EN 61000-4-5:2014,
EN 61000-4-6:2014, EN 61000-4-8:2010, EN 61000-4-11:2004

Prepared by(Test Engineer): *Wilew Shi*

Reviewer(Supervisor): *Jamie Zou*

Approved(Manager): 



1. GENERAL INFORMATION

1.1. Description of Device (EUT)

EUT : Neon Lights Modelling

Trademark : N/A

Model Number : Desktop Modeling

Model Difference : The product is different for model number and outlook color.

Power Supply : DC4.5V===

Work Frequency : Below 108MHz

Note: Desktop Modeling was selected as the test model and the datas have been recorded in this report.

1.2. Tested System Details

Personal Computer : DELL Monitor : SONY
M/N : INSPIRON M/N : MNT1

Printer : EPSON STYLUS Keyboard (USB) : Genuine
M/N : P320A M/N : N/A

Modem : ACEEX Mouse : DETROIS
M/N : DM-1414 M/N : CM309

1.3. Test Uncertainty

Conducted Emission Uncertainty : ± 2.48 dB

Radiated Emission Uncertainty : ± 4.14 dB



1.4. Test Facility

Site Description

Name of Firm : Shenzhen BKC Testing Co., Ltd.

Site Location : 6/F, Building 3, Zhouteng Industrial Park, Nanwan Street,
Longgang District, Shenzhen, Guangdong, China.





2. TEST INSTRUMENT USED

2.1 CONDUCTED TEST SITE

Item	Kind of Equipment	Manufacturer	Type No.	Serial No.	Calibrated until
1	LISN	R&S	ENV216	101313	Nov. 20, 2018
2	LISN	EMCO	3816/2	00042990	Nov. 20, 2018
3	50Ω Switch	ANRITSU CORP	MP59B	6200983704	Nov. 20, 2018
4	EMI Test Receiver	R&S	ESCI	101160	Nov. 20, 2018
5	Passive Voltage Probe	ESH2-Z3	R&S	100196	Nov. 20, 2018
6	Triple-Loop Antenna	EVERFINE	LIA-2	11020003	Nov. 20, 2018
7	Absorbing Clamp	R&S	MDS-21	100423	Nov. 20, 2018
8	Coupling/ Decoupling Network	PH	ISN T800	S1509001	Nov. 20, 2018

2.2 MAGNETIC EMISSION

Item	Kind of Equipment	Manufacturer	Type No.	Serial No.	Calibrated until
1	Three-loop antenna	DAZE	ZN30401	13017	Nov. 20, 2018
2	EMI Test Receiver	R&S	ESCI-7	101318	Nov. 20, 2018
3	50Ω Switch	Anritsu Corp	MP59B	6200983705	Nov. 20, 2018

2.3 RADIATED TEST SITE

Item	Kind of Equipment	Manufacturer	Type No.	Serial No.	Calibrated until
1	Bilog Antenna	TESEQ	CBL6111D	31216	Nov. 20, 2018
2	EMI Test Receiver	R&S	ESCI-7	101318	Nov. 20, 2018
3	Antenna Mast	EM	SC100_1	N/A	Nov. 20, 2018
4	50Ω Switch	Anritsu Corp	MP59B	6200983705	Nov. 20, 2018
5	Spectrum Analyzer	Aglient	E4407B	MY45108040	Nov. 20, 2018
6	Horn Antenna	EM	EM-AH-1018 0	2011071402	Nov. 20, 2018
7	Amplifier	EM	EM-30180	060538	Nov. 20, 2018

2.4 HARMONICS AND FILCK

Item	Kind of Equipment	Manufacturer	Type No.	Serial No.	Calibrated until
1	Harmonic & Flicker	EM TEST	DPA500	0303-04	Nov. 20, 2018
2	AC Power Source	EM TEST	ACS500	0203-01	Nov. 20, 2018



2.5 Electrostatic Discharge

Item	Kind of Equipment	Manufacturer	Type No.	Serial No.	Calibrated until
1	ESD TEST GENERATOR	EVERFINE	EMS61000-2 A-V200	11040001T	Nov. 20, 2018

2.6 RS

Item	Kind of Equipment	Manufacturer	Type No.	Serial No.	Calibrated until
1	Signal Generator	R&S	SMT 06	832080/007	Nov. 20, 2018
2	Log-Bicon Antenna	Schwarzbeck	VULB9161	4022	Nov. 20, 2018
3	Power Amplifier	AR	150W1000M1	320946	Nov. 20, 2018
4	Microwave Horn Antenna	AR	AT4002A	321467	Nov. 20, 2018
5	Power Amplifier	AR	25S1G4A	308598	Nov. 20, 2018

2.7 SURGE, EFT/BURST, VOLTAGE INTERRUPTION/DIPS

Item	Kind of Equipment	Manufacturer	Type No.	Serial No.	Calibrated until
1	Surge Generator	EVERFINE	EMS61000-5 A	1101002	Nov. 20, 2018
2	DIPS Generator	EVERFINE	EMS61000-11 K	1011002	Nov. 20, 2018
3	EFT/B Generator	Schaffner	MODULA615 0	34437	Nov. 20, 2018

2.8 INJECTION CURRENT

Item	Kind of Equipment	Manufacturer	Type No.	Serial No.	Calibrated until
1	Signal Generator	IFR	2023A	202301/368	Nov. 20, 2018
2	Power Amplifier	AR	75A250AM1	0320709	Nov. 20, 2018
3	CDN	FCC	FCC-801-M2	06043	Nov. 20, 2018
4	EM Clamp	FCC	F-203I-23MM	504	Nov. 20, 2018

2.9 Magnetic Field Immunity

Item	Kind of Equipment	Manufacturer	Type No.	Serial No.	Calibrated until
1	Generator	EVERFINE	EMS61000-8 K	1007001	Nov. 20, 2018

3. CONDUCTED EMISSION AT THE MAINS TERMINALS TEST

3.1. Block Diagram Of Test Setup

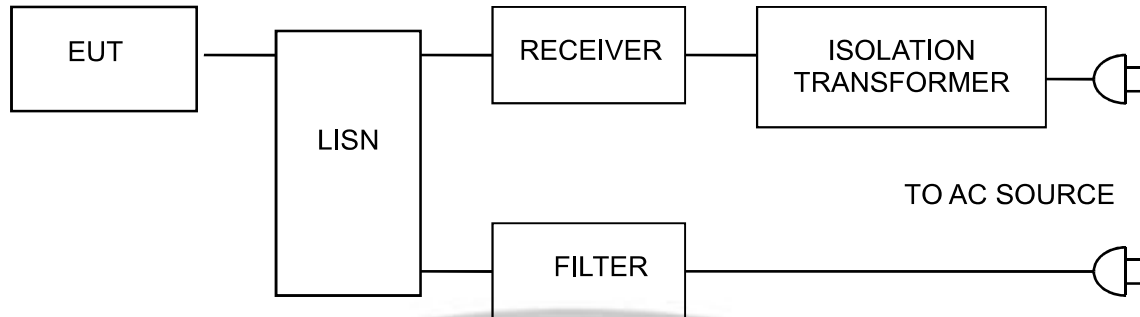

3.2. Test Standard

EN 55015: 2013+A1:2015

3.3. Power Line Conducted Emission Limit

Frequency MHz	Limits dB(μ V)	
	Quasi-peak Level	Average Level
0.15 ~ 0.50	66 ~ 56*	56 ~ 46*
0.50 ~ 5.00	56	46
5.00 ~ 30.00	60	50

Notes: 1. *Decreasing linearly with logarithm of frequency.

2. The lower limit shall apply at the transition frequencies.

3.4. EUT Configuration on Test

The following equipments are installed on conducted emission test to meet EN 55015 requirement and operating in a manner which tends to maximize its emission characteristics in a normal application.

3.5. Operating Condition of EUT

3.5.1 Setup the EUT and simulators as shown in Section 3.1.

3.5.2 Turn on the power of all equipments.

3.5.3 Let the EUT work in test modes and test it.

3.6. Test Procedure

The EUT is put on the ground and connected to the AC mains through a Artificial Mains Network (AMN). This provided a 50ohm coupling impedance for the tested equipments. Both sides of AC line are checked to find out the maximum conducted emission levels according to the EN 55015 regulations during conducted emission test.

The bandwidth of the test receiver (R&S Test Receiver ESCI) is set at 10KHz.

The frequency range from 150 KHz to 30 MHz is investigated.

3.7. Test Result

The product's power provide by DC, no requirement for this item.



4. MAGNETIC EMISSION TEST

4.1. Block Diagram Of Test Setup

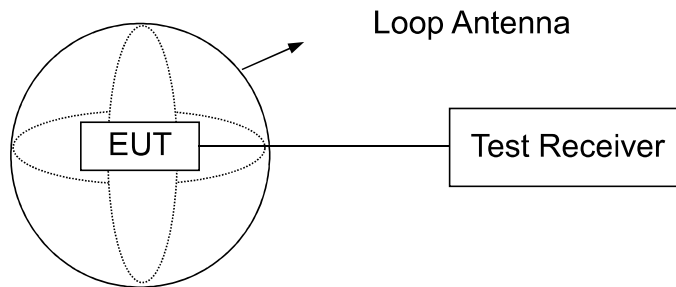

4.2. Test Standard

EN 55015:2013+A1:2015

4.3. Power Line Conducted Emission Limit

Frequency MHz	Limits dB(μ A)
	Quasi-peak Level
0.009 ~ 0.07	88
0.07 ~ 0.15	88 ~ 58*
0.15 ~ 0.50	58 ~ 22*
0.50 ~ 5.00	22

Notes: 1. *Decreasing linearly with logarithm of frequency.
2. The lower limit shall apply at the transition frequencies.

4.4. EUT Configuration on Test

The following equipments are installed on conducted emission test to meet EN55015 requirement and operating in a manner which tends to maximize its emission characteristics in a normal application.

4.5. Operating Condition of EUT

- 4.5.1 Setup the EUT and simulators as shown in Section 4.1.
- 4.5.2 Turn on the power of all equipments.
- 4.5.3 Let the EUT work in test modes and test it.

4.6. Test Procedure

The EUT is placed on a wood table in the center of a loop antenna. The induced current in the loop antenna is measured by means of a current probe and the test receiver. Three field components is checked by means of a coax Neon Lights Modelling.

The frequency range from 9KHz to 30MHz is investigated. The receiver is measured with the quasi-peak detector. For frequency band 9KHz to 150KHz, the bandwidth of the field strength meter (R&S Test Receiver ESCI) is set at 200Hz. For frequency band 150KHz to 30MHz , the bandwidth is set at 10KHz.

4.7. Test Result

PASS

Please refer to the following page.





Magnetic Emission Test Data			
Temperature:	25.1°C	Relative Humidity:	56%
Pressure:	1008hPa	Ant. Polarity	X
Test Voltage :	DC4.5V	Test Mode:	ON Mode

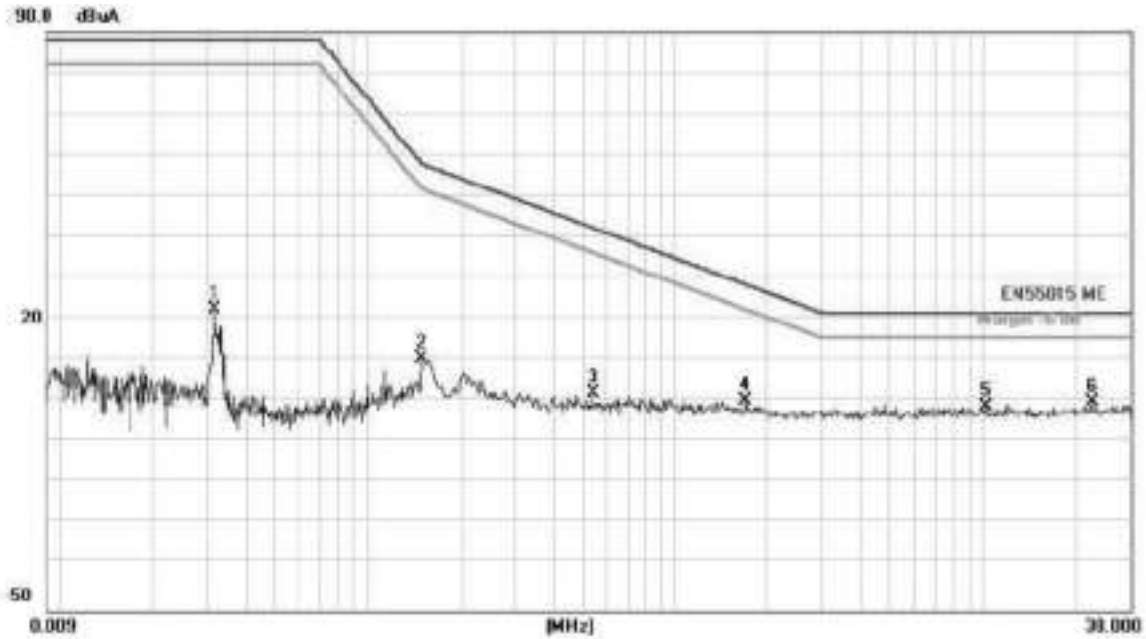

No. Mk.	Freq. MHz	Reading Level dBuA	Correct Factor dB	Measurement dBuA	Limit dBuA	Over dB	Detector	Comment
1	0.0316	0.45	22.45	22.90	88.00	-65.10	QP	
2	0.1500	-15.87	27.00	11.13	58.00	-46.87	QP	
3	0.5380	-24.29	27.00	2.71	42.65	-39.94	QP	
4	1.6940	-25.95	27.00	1.05	28.87	-27.82	QP	
5	10.2620	-27.53	27.00	-0.53	22.00	-22.53	QP	
6 *	22.5820	-26.57	27.00	0.43	22.00	-21.57	QP	



Magnetic Emission Test Data			
Temperature:	25.1°C	Relative Humidity:	56%
Pressure:	1008hPa	Ant. Polarity	Y
Test Voltage :	DC4.5V	Test Mode:	ON Mode

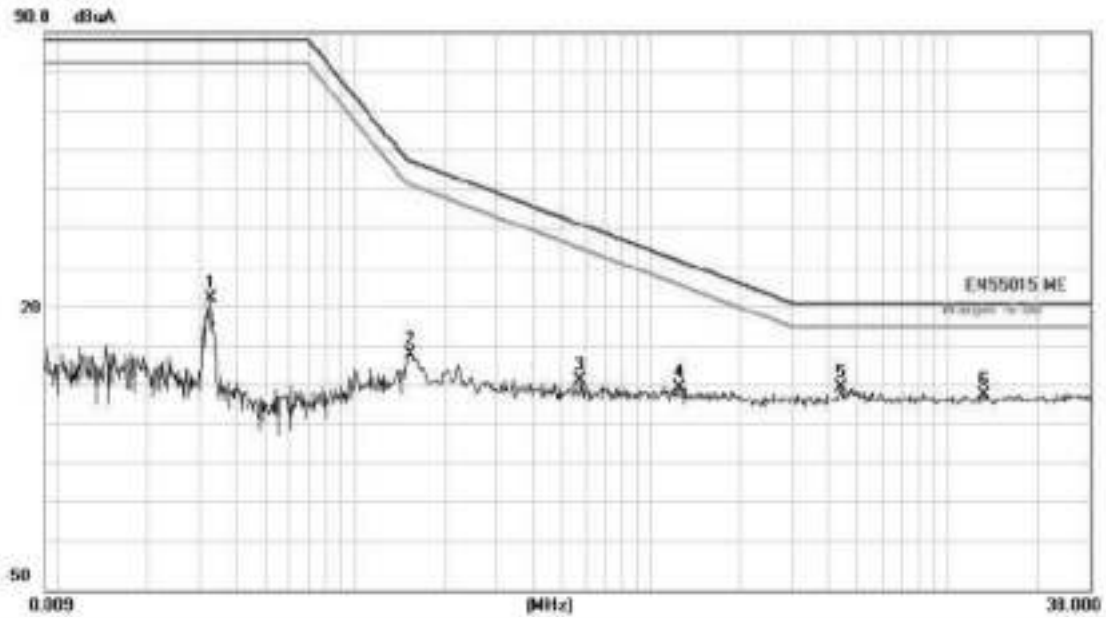

No. Mk.	Freq. MHz	Reading Level dBuA	Correct Factor dB	Measurement dBuA	Limit dBuA	Over dB	Detector	Comment
1	0.0330	1.12	22.27	23.39	88.00	-64.61	QP	
2	0.1540	-17.77	27.00	9.23	57.68	-48.45	QP	
3	0.5820	-24.33	27.00	2.67	41.71	-39.04	QP	
4	1.2460	-26.09	27.00	0.91	32.56	-31.65	QP	
5 *	4.3540	-26.16	27.00	0.84	22.00	-21.16	QP	
6	13.2740	-27.70	27.00	-0.70	22.00	-22.70	QP	



Magnetic Emission Test Data			
Temperature:	25.1°C	Relative Humidity:	56%
Pressure:	1008hPa	Ant. Polarity	Z
Test Voltage :	DC4.5V	Test Mode:	ON Mode

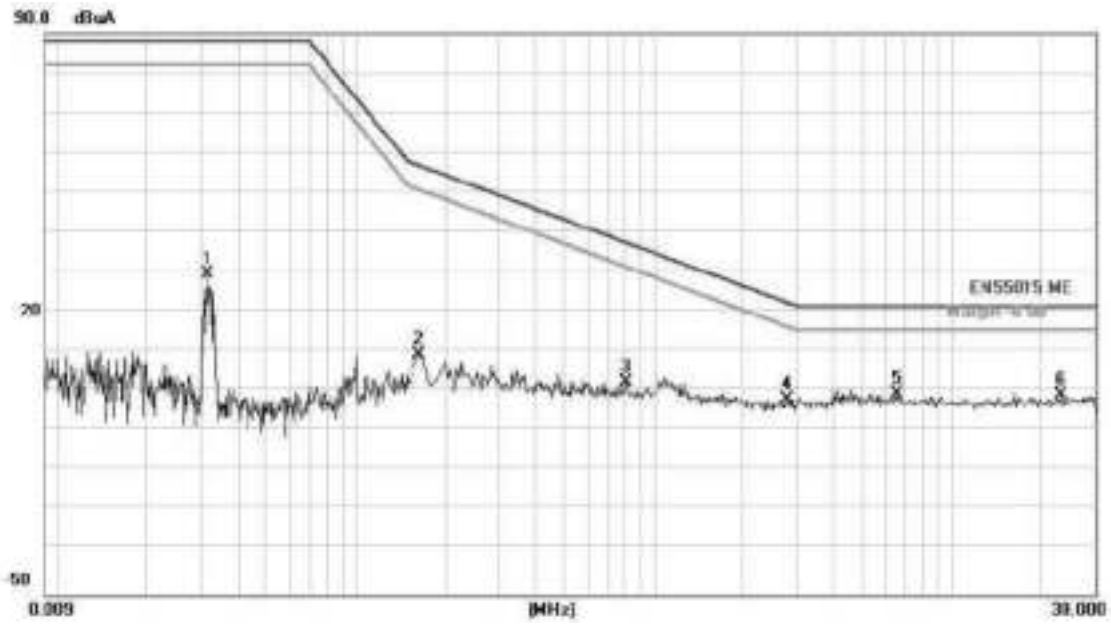

No. Mk.	Freq. MHz	Reading Level dBuA	Correct Factor dB	Measurement dBuA	Limit dBuA	Over dB	Detector	Comment
1	0.0317	7.41	22.44	29.85	88.00	-58.15	QP	
2	0.1620	-16.96	27.00	10.04	57.08	-47.04	QP	
3	0.8100	-23.99	27.00	-3.01	37.73	-34.72	QP	
4	2.8060	-28.05	27.00	-1.05	22.80	-23.85	QP	
5 *	6.5220	-26.80	27.00	0.20	22.00	-21.80	QP	
6	22.9900	-27.29	27.00	-0.29	22.00	-22.29	QP	

5. RADIATION EMISSION TEST

5.1. Block Diagram of Test Setup

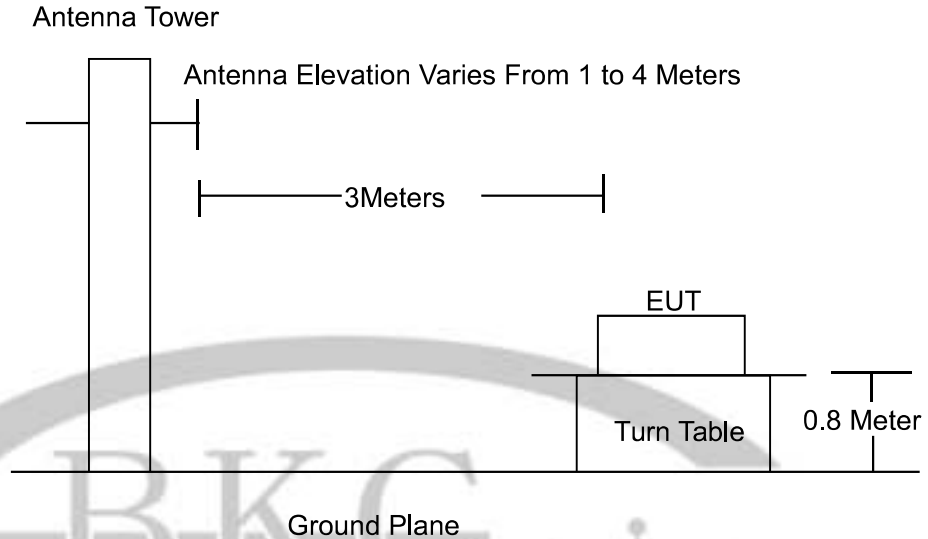

5.2. Test Standard

EN 55015: 2013+A1:2015

5.3. Radiation Limit

Frequency MHz	Distance (Meters)	Field Strengths Limits dB(μ V)/m
30 ~ 230	3	40.0
230 ~ 300	3	47.0

Remark:

(1) Emission level (dB(μ V)/m) = 20 log Emission level (μ V/m)

(2) The smaller limit shall apply at the cross point between two frequency bands.

(3) Distance refers to the distance in meters between the measuring instrument, antenna and the closed point of any part of the device or system.

5.4. EUT Configuration on Test

The EN 55015 regulations test method must be used to find the maximum emission during radiated emission test.

The configuration of EUT is the same as used in conducted emission test. Please refer to Section 2.3.

5.5. Operating Condition of EUT

Same as conducted emission test, which is listed in Section 2.3 except the test set up replaced as Section 5.1.

5.6. Test Procedure

The EUT and its simulators are placed on a turned table that is 0.8 meter above the ground. The turned table can rotate 360 degrees to determine the position of the maximum emission level. The EUT is set 3 meters away from the receiving antenna that is mounted on the antenna tower. The antenna can move up and down between 1 meter and 4 meters to find out the maximum emission level. Broadband antenna (calibrated biconical and log periodical antenna) is used as receiving antenna. Both horizontal and vertical polarization of the antenna is set on test. In order to find the maximum emission levels, the interface cable must be manipulated according to EN 55015 on radiated emission test.

The bandwidth setting on the field strength meter (R&S Test Receiver ESCI) is set at 120KHz below 1GHz, set at 1MHz above 1GHz

The frequency range from 30MHz to 1000MHz is checked.

5.7. Test Result

PASS

Please refer to the following page.



Radiation Emission Test Data			
Temperature:	25.1°C	Relative Humidity:	56%
Pressure:	1008hPa	Phase :	Horizontal
Test Voltage :	DC4.5V	Test Mode:	On Mode

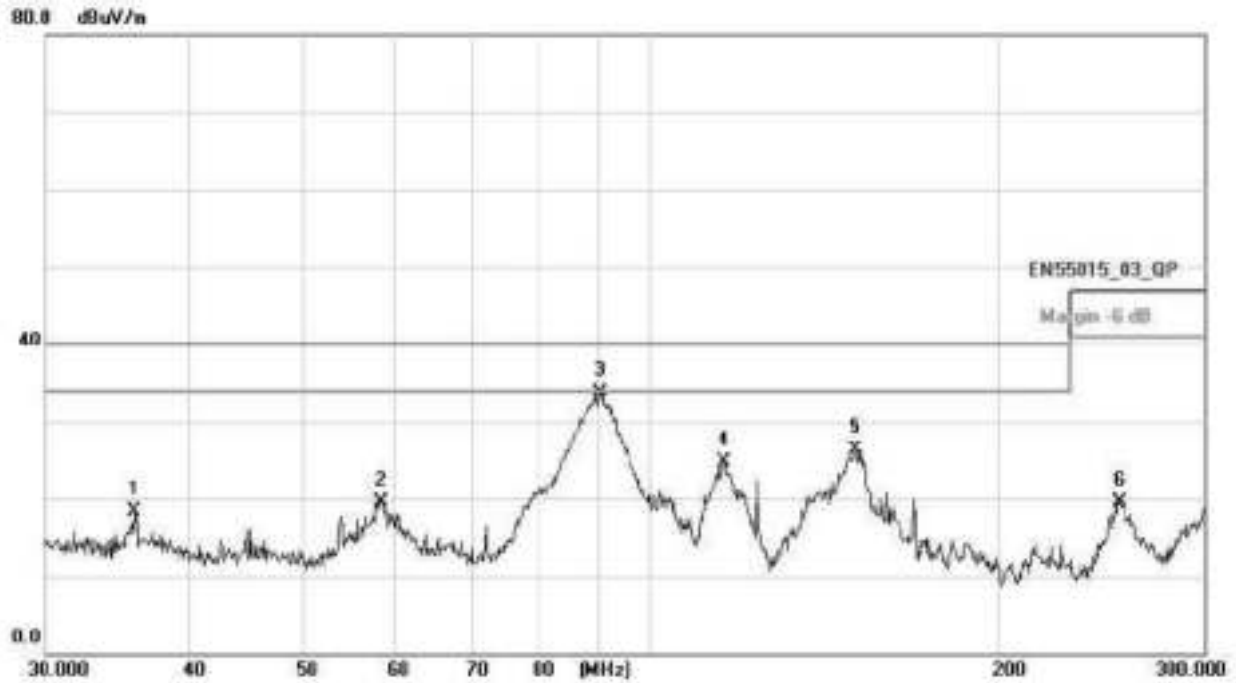

No. Mk.	Freq. MHz	Reading Level dBuV	Correct Factor dBm	Measurement dBuV/m	Limit dBuV/m	Over dB	Detector	Antenna Height cm	Table Degree	Comment
1	35.7373	26.90	-8.56	18.34	40.00	-21.66	QP			
2	58.4953	30.96	-11.39	19.57	40.00	-20.43	QP			
3 *	90.3902	51.10	-17.47	33.63	40.00	-6.37	QP			
4	115.6435	39.88	-15.08	24.80	40.00	-15.20	QP			
5	150.0104	39.22	-12.86	26.36	40.00	-13.64	QP			
6	253.5837	33.68	-14.10	19.58	47.00	-27.42	QP			



Radiation Emission Test Data			
Temperature:	25.1°C	Relative Humidity:	56%
Pressure:	1008hPa	Phase :	Vertical
Test Voltage :	DC4.5V	Test Mode:	On Mode

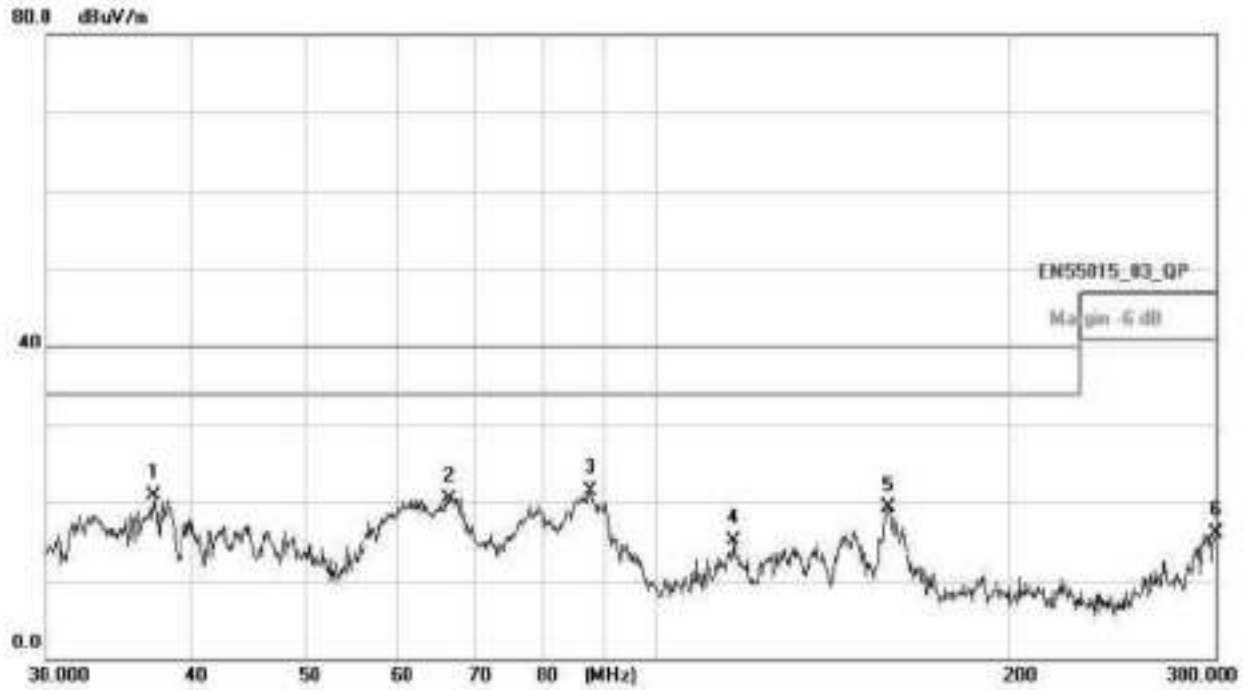

No.	Mk.	Freq. MHz	Reading Level dBuV	Correct Factor dBm	Measure- ment dBuV/m	Limit dBuV/m	Over dB	Antenna Height cm	Table Degree	Detector	Comment
1		37.1639	29.50	-8.69	20.81	40.00	-19.19	QP			
2		66.3928	33.56	-13.08	20.48	40.00	-19.52	QP			
3	*	87.7246	39.21	-17.79	21.42	40.00	-18.58	QP			
4		116.4450	30.19	-15.05	15.14	40.00	-24.86	QP			
5		157.8052	32.18	-12.87	19.31	40.00	-20.69	QP			
6		300.0000	28.63	-12.58	16.05	47.00	-30.95	QP			

6. HARMONIC CURRENT EMISSION TEST

6.1. Block Diagram of Test Setup

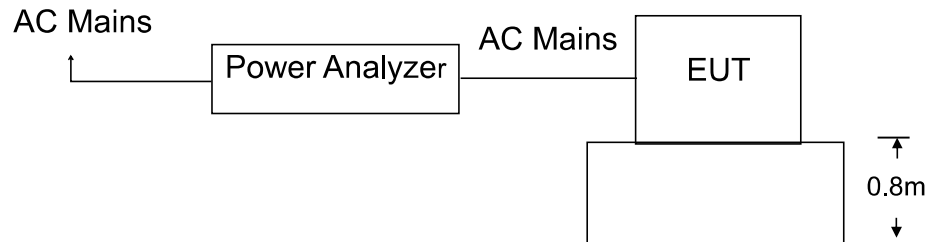

6.2. Test Standard

EN 61000-3-2:2014

6.3. Operating Condition of EUT

6.1.1 Setup the EUT as shown in Section 6.1.

6.1.2 Turn on the power of all equipments.

6.1.3 Let the EUT work in test mode and test it.

6.4. Test Procedure

The power cord of the EUT is connected to the output of the test system. Turn on the power of the EUT and use the test system to test the harmonic current level.

6.5. Test Results

The product's power provide by DC, no requirement for this item.



7. VOLTAGE FLUCTUATIONS & FLICKER TEST

7.1. Block Diagram of Test Setup

Same as Section 6.1..

7.2. Test Standard

EN 61000-3-3:2013

7.3. Operating Condition of EUT

Same as Section 6.3.. The power cord of the EUT is connected to the output of the test system. Turn on the power of the EUT and use the test system to test the harmonic current level.

Flicker Test Limit

Test items	Limits
Pst	1.0
dc	3.3%
dmax	4.0%
dt	Not exceed 3.3% for 500ms

7.4. Test Procedure

The power cord of the EUT is connected to the output of the test system. Turn on the power of the EUT and use the test system to test the harmonic current level.

7.5. Test Results

The product's power provide by DC, no requirement for this item.

8. ELECTROSTATIC DISCHARGE IMMUNITY TEST

8.1. Block Diagram of Test Setup

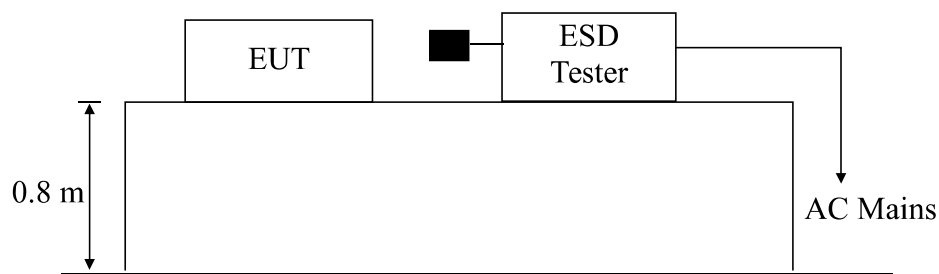

8.2. Test Standard

EN 61547:2009, EN 61000-4-2:2009

Severity Level: 3 / Air Discharge: ± 8 KV

Level: 2 / Contact Discharge: ± 4 KV

8.3. Severity Levels and Performance Criterion

8.3.1 Severity level

Level	Test Voltage Contact Discharge (KV)	Test Voltage Air Discharge (KV)
1.	± 2	± 2
2.	± 4	± 4
3.	± 6	± 8
4.	± 8	± 15
X	Special	Special

8.3.2 Performance criterion : B

- A.** The apparatus shall continue to operate as intended during and after the test. No degradation of performance or loss of function is allowed below a performance level specified by the manufacturer, when the apparatus is used as intended.

- B.** The apparatus shall continue to operate as intended after the test. No degradation of performance or loss of function is allowed below a performance level specified by the manufacturer, when the apparatus is used as intended. The performance level may be replaced by a permissible loss of performance. During the test, degradation of performance is however allowed.

- C.** Temporary loss of function is allowed, provided the function is self-recoverable or can be restored by the operation of the controls.

8.4.EUT Configuration

The following equipments are installed on Electrostatic Discharge Immunity test to meet EN 61547:2009, EN 61000-4-2:2009, requirement and operating in a manner which tends to maximize its emission characteristics in a normal application. The configuration of EUT is the same as used in conducted emission test.

Please refer to Section 2.5.

8.5.Operating Condition of EUT

Same as conducted emission measurement, which is listed in Section 3.5 except the test setup replaced by Section 8.1.

8.6.Test Procedure

8.6.1 Air Discharge:

This test is done on a non-conductive surface. The round discharge tip of the discharge electrode shall be approached as fast as possible to touch the EUT. After each discharge, the discharge electrode shall be removed from the EUT. The generator is then re-triggered for a new single discharge and repeated 10 times for each pre-selected test point. This procedure shall be repeated until all the air discharge completed.

8.6.2 Contact Discharge:

All the procedure shall be same as Section 8.6.1. Except that the tip of the discharge electrode shall touch the EUT before the discharge Switch is operated.



8.6.3 Indirect discharge for horizontal coupling plane

At least 10 single discharges (in the most sensitive polarity) shall be applied at the front edge of each HCP opposite the center point of each unit (if applicable) of the EUT and 0.1m from the front of the EUT. The long axis of the discharge electrode shall be in the plane of the HCP and perpendicular to its front edge during the discharge.

8.6.4 Indirect discharge for vertical coupling plane

At least 10 single discharges (in the most sensitive polarity) shall be applied to the center of one vertical edge of the coupling plane. The coupling plane, of dimensions 0.5m X 0.5m, is placed parallel to, and positioned at a distance of 0.1m from the EUT. Discharges shall be applied to the coupling plane, with this plane in sufficient different positions that the four faces of the EUT are complete illuminated.

8.7. Test Results

PASS

Please refer to the following page.

ESD Test Data				
Temperature:	25.1°C	Humidity:	54%	
Power Supply :	DC4.5V	Test Mode:	On	
Air Discharge: ± 8KV Contact Discharge: ± 4KV # For each point positive 25 times and negative 25 times discharge				
Test Points	Air Discharge	Contact Discharge	Performance Criterion	Result
Enclosure	±2,4,8KV	N/A	B	PASS
Slit	±2,4,8KV	N/A	B	PASS
Screw	N/A	±2,4 KV	B	PASS
VCP	N/A	±2,4 KV	B	PASS
HCP	N/A	±2,4 KV	B	PASS
Note: N/A				

9. RF FIELD STRENGTH SUSCEPTIBILITY TEST

9.1. Block Diagram of Test Setup

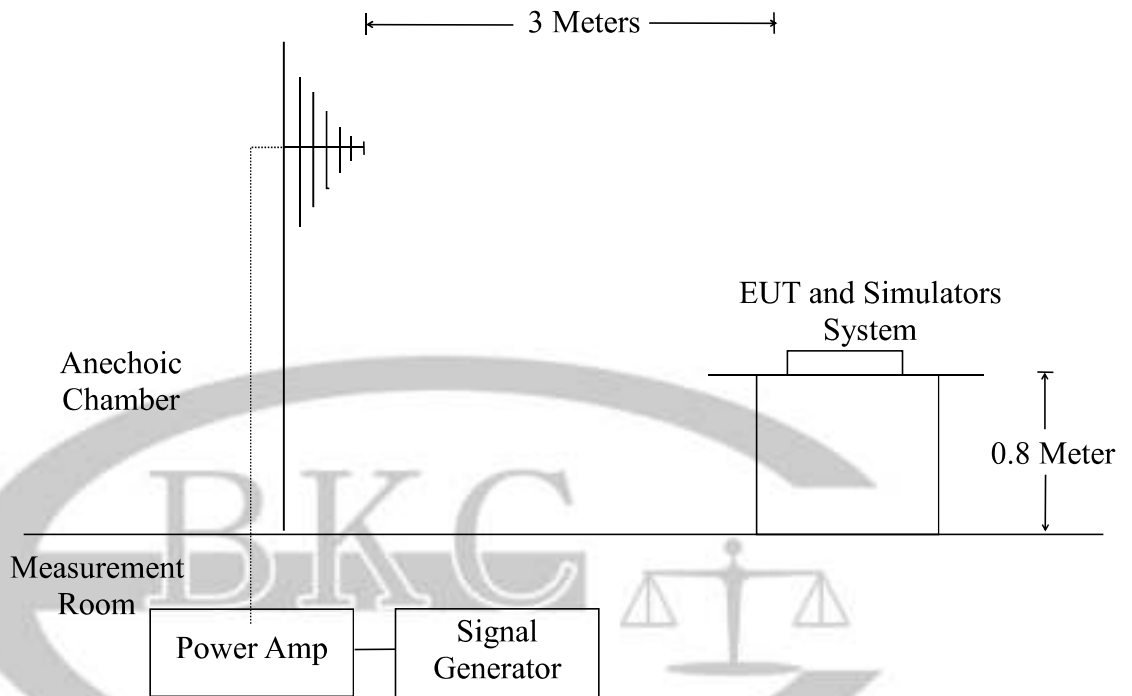

9.2. Test Standard

EN 61547:2009, EN 61000-4-3: 2006+A1:2008+A2:2010
Severity Level 2, 3V / m

9.3. Severity Levels and Performance Criterion

9.3.1. Severity level

Level	Field Strength V/m
1.	1
2.	3
3.	10
X.	Special

9.3.2. Performance criterion: A

- A、 The apparatus shall continue to operate as intended during and after the test. No degradation of performance or loss of function is allowed below a performance level specified by the manufacturer, when the apparatus is used as intended.
- B、 The apparatus shall continue to operate as intended after the test. No degradation of performance or loss of function is allowed below a performance level specified by the manufacturer, when the apparatus is used as intended. The performance level may be replaced by a permissible loss of performance. During the test, degradation of performance is however allowed.
- C、 Temporary loss of function is allowed, provided the function is self-recoverable or can be restored by the operation of the controls.

9.4. EUT Configuration on Test

The following equipments are installed on Electrical Fast Transient/Burst Immunity test to meet EN 61547:2009, EN 61000-4-4:2012, requirement and operating in a manner which tends to maximize its emission characteristics in a normal application. The configuration of EUT is the same as used in conducted emission test.

Please refer to Section 3.4.

9.5. Operating Condition of EUT

Same as conducted emission measurement, which is listed in Section 2.6 except the test setup replaced by Section 9.1.



9.6. Test Procedure

The EUT and its simulators are placed on a turn table which is 0.8 meter above ground. EUT is set 3 meter away from the transmitting antenna which is mounted on an antenna tower. Both horizontal and vertical polarization of the antenna are set on test. Each of the four sides of EUT must be faced this transmitting antenna and measured individually.

All the scanning conditions are as follows :

Condition of Test	Remarks
1. Fielded Strength	3 V/m (Severity Level 2)
2. Radiated Signal	Modulated
3. Scanning Frequency	80 – 1000 MHz
4. Dwell time of radiated	0.0015 decade/s
5. Waiting Time	1 Sec.

9.7. Test Results

PASS

Please refer to the following page.

R/S Test Data			
Temperature : 25.1°C		Humidity : 53%	
Field Strength: 3 V/m		Criterion: A	
Power Supply: DC4.5V		Frequency Range: 80 MHz to 1000 MHz	
Modulation: <input checked="" type="checkbox"/> AM <input type="checkbox"/> Pulse <input type="checkbox"/> none 1 KHz 80%			
Test Mode : On			
Frequency Range : 80-1000MHz			
Steps 1 %			
	Horizontal	Vertical	Result
Front	A	A	Pass
Right	A	A	Pass
Rear	A	A	Pass
Left	A	A	Pass
Note: N/A			

10. ELECTRICAL FAST TRANSIENT/BURST IMMUNITY TEST

10.1. Block Diagram of EUT Test Setup

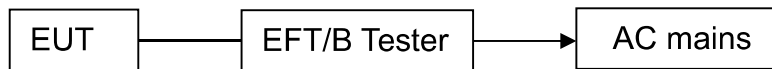

10.2. Test Standard

EN 61547:2009, EN 61000-4-4:2012

10.3. Severity Levels and Performance Criterion

Severity Level 2 at 1KV, Pulse Rise time & Duration: 5 nS / 50 nS

Severity Level:

Open Circuit Output Test Voltage $\pm 10\%$		
Level	On power ports	On I/O(Input/Output) Signal data and control ports
1.	0.5KV	0.25KV
2.	1KV	0.5KV
3.	2KV	1KV
4.	4KV	2KV
X.	Special	Special

Performance criterion: B

- A. The apparatus shall continue to operate as intended during and after the test. No degradation of performance or loss of function is allowed below a performance level specified by the manufacturer, when the apparatus is used as intended.
- B. The apparatus shall continue to operate as intended after the test. No degradation of performance or loss of function is allowed below a performance level specified by the manufacturer, when the apparatus is used as intended. The performance level may be replaced by a permissible loss of performance. During the test, degradation of performance is however allowed.
- C. Temporary loss of function is allowed, provided the function is self-recoverable or can be restored by the operation of the controls.



10.4. EUT Configuration on Test

The following equipments are installed on Electrical Fast Transient/Burst Immunity test to meet EN 61547:2009, EN 61000-4-4:2012, requirement and operating in a manner which tends to maximize its emission characteristics in a normal application. The configuration of EUT is the same as used in conducted emission test.

Please refer to Section 3.4.

10.5. Operating Condition of EUT

Same as conducted emission measurement, which is listed in Section 2.7 except the test setup replaced by Section 10.1.

10.6. Test Procedure

EUT shall be placed 0.8m high above the ground reference plane which is a min.1m*1m metallic sheet with 0.65mm minimum thickness. This reference ground plane shall project beyond the EUT by at least 0.1m on all sides and the minimum distance between EUT and all other conductive structure, except the ground plane beneath the EUT, shall be more than 0.5m

10.6.1. For input and output AC power ports:

The EUT is connected to the power mains by using a coupling device which couples the EFT interference signal to AC power lines. Both polarities of the test voltage should be applied during compliance test and the duration of the test is 2 minutes.

10.7. Test Results

The product's power provide by DC, no requirement for this item.

11. SURGE TEST

11.1. Block Diagram of EUT Test Setup

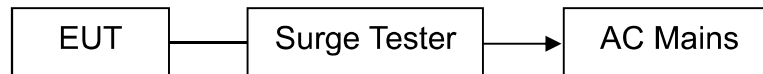

11.2. Test Standard

EN 61547:2009, EN61000-4-5:2014

11.3. Severity Levels and Performance Criterion

Severity Level: Line to Line, Level 2 at 1KV;

Severity Level: Line to Earth, Level 3 at 2KV.

Severity Level	Open-Circuit Test Voltage (KV)
1.	0.5
2.	1.0
3.	2.0
4.	4.0
X.	Special

Performance criterion: B

- A. The apparatus shall continue to operate as intended during and after the test. No degradation of performance or loss of function is allowed below a performance level specified by the manufacturer, when the apparatus is used as intended.
- B. The apparatus shall continue to operate as intended after the test. No degradation of performance or loss of function is allowed below a performance level specified by the manufacturer, when the apparatus is used as intended. The performance level may be replaced by a permissible loss of performance. During the test, degradation of performance is however allowed.
- C. Temporary loss of function is allowed, provided the function is self-recoverable or can be restored by the operation of the controls.



11.4. EUT Configuration on Test

The following equipments are installed on Electrical Fast Transient/Burst Immunity test to meet EN 61547:2009, EN61000-4-5:2014, requirement and operating in a manner which tends to maximize its emission characteristics in a normal application

The configuration of EUT is the same as used in conducted emission test. Please refer to Section 3.4.

11.5. Operating Condition of EUT

Same as conducted emission measurement, which is listed in Section 2.7 except the test setup replaced by Section 11.1.

11.6. Test Procedure

- 1) Set up the EUT and test generator as shown on section 10.1
- 2) For line to line coupling mode, provide a 1KV 1.2/50us voltage surge (at open-circuit condition) and 8/20us current surge to EUT selected points.
- 3) At least 5 positive and 5 negative (polarity) tests with a maximum 1/min repetition rate are conducted during test.
- 4) Different phase angles are done individually.
- 5) Repeat procedure 2) to 4) except the open-circuit test voltage change from 1KV to 2KV for line to earth coupling mode test.
- 6) Record the EUT operating situation during compliance test and decide the EUT immunity criterion for above each test.

11.7. Test Result

The product's power provide by DC, no requirement for this item.

12. INJECTED CURRENTS SUSCEPTIBILITY TEST

12.1. Block Diagram of EUT Test Setup

11.1.1. Block Diagram of EUT Test Setup

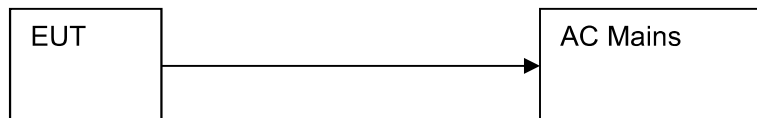

11.1.2. Block Diagram of Test Setup

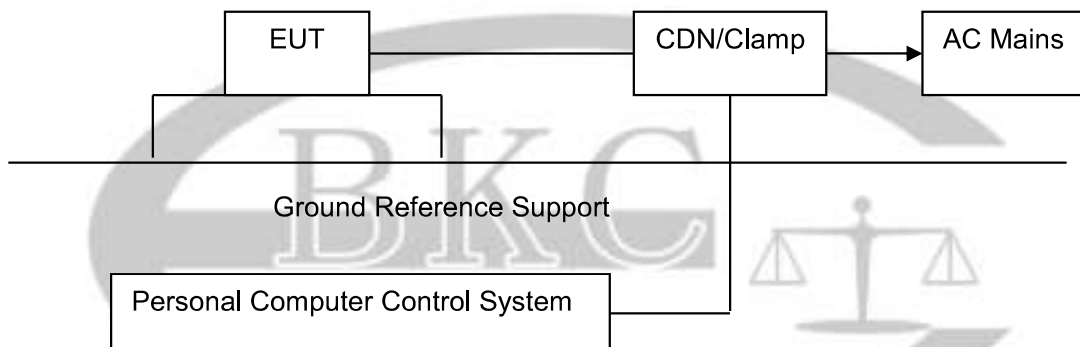

12.2. Test Standard

EN 61547:2009, EN61000-4-6:2014

12.3. Severity Levels and Performance Criterion

Severity Level 2: 3V(rms), 150KHz ~ 80MHz

Severity Level:

Level	Field Strength V
1.	1
2.	3
3.	10
X.	Special

Performance criterion: A

- A. The apparatus shall continue to operate as intended during and after the test. No degradation of performance or loss of function is allowed below a performance level specified by the manufacturer, when the apparatus is used as intended.
- B. The apparatus shall continue to operate as intended after the test. No degradation of performance or loss of function is allowed below a performance level specified by the manufacturer, when the apparatus is used as intended. The performance level may be replaced by a permissible loss of performance. During the test, degradation of performance is however allowed.
- C. Temporary loss of function is allowed, provided the function is self-recoverable or can be restored by the operation of the controls.

12.4. EUT Configuration on Test

The configuration of EUT is the same as used in conducted emission test. Please refer to Section 2.7.

12.5. Operating Condition of EUT

Same as conducted emission test, which is listed in Section 2.8 except the test set up replaced as Section 12.1.

12.6. Test Procedure

- 1) Set up the EUT, CDN and test generator as shown on section 12.1
- 2) Let EUT work in test mode and measure.
- 3) The EUT and supporting equipments are placed on an insulating support 0.1m high above a ground reference plane. CDN (coupling and decoupling device) is placed on the ground plane at above 0.1-0.3m from EUT. Cables between CDN and EUT are as short as possible, and their height above the ground reference plane shall be between 30 and 50 mm (where possible).
- 4) The disturbance signal described below is injected to EUT through CDN.
- 5) The EUT operates within its operational mode(s) under intended climatic conditions after power on.
- 6) The frequency range is swept from 150KHz to 80MHz using 3V signal level, and with the disturbance signal 80% amplitude modulated with a 1KHz sine wave
- 7) The rate of sweep shall not exceed 1.5×10^{-3} decades/s. Where the frequency is swept incrementally, the step size shall not exceed 1% of the start and thereafter 1% of the preceding frequency value.



- 8) Recording the EUT operating situation during compliance test and decide the EUT immunity criterion for above each test.

12.7. Test Result

The product's power provide by DC, no requirement for this item.



13. MAGNETIC FIELD IMMUNITY TEST

13.1. Block Diagram of Test Setup

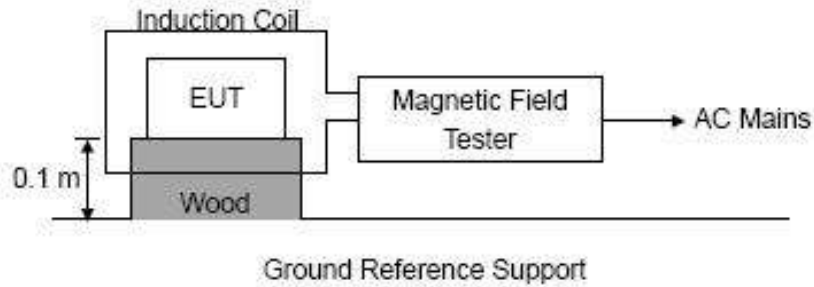

13.2. Test Standard

EN 61547:2009, EN61000-4-8:2010
Severity Level 1 at 1A/m

13.3. Severity Levels and Performance Criterion

13.3.1 Severity level

Level	Magnetic Field Strength A/m
1.	1
2.	3
3.	10
4.	30
5.	100
X.	Special

13.3.2 Performance criterion: B

- A. The apparatus shall continue to operate as intended during and after the test.
- B. No degradation of performance or loss of function is allowed below a performance level specified by the manufacturer, when the apparatus is used as intended.
- C. The apparatus shall continue to operate as intended after the test. No degradation of performance or loss of function is allowed below a performance level specified by the manufacturer, when the apparatus is used as intended. The performance level may be replaced by a permissible loss of performance. During the test, degradation of performance is however allowed.



D. Temporary loss of function is allowed, provided the function is self-recoverable or can be restored by the operation of the controls.

13.4. EUT Configuration on Test

The configuration of EUT is listed in Section 2.9.

13.5. Operating Condition of EUT

Same as conducted emission test, which is listed in Section 2.9 except the test set up replaced as Section 13.1.

13.6. Test Procedure

The EUT shall be subjected to the test magnetic field by using the induction coil of standard dimensions (1m*1m) and shown in Section 13.1. The induction coil shall then be rotated by 90° in order to expose the EUT to the test field with different orientations.

13.7. Test Results

PASS

Please refer to the following page.

MS Test Data					
Temperature:	24.5°C	Humidity:	53%		
Power Supply :	DC4.5V	Test Mode:	On		
Environmental Phenomena	Test specification	Units	Coil Orientation	Performance Criterion	Result
Magnetic Field	1	A/m	X	A	PASS
			Y	A	PASS
			Z	A	PASS
Note: N/A					

14. VOLTAGE DIPS AND INTERRUPTIONS TEST

14.1. Block Diagram of EUT Test Setup



14.2. Test Standard

EN 61547:2009, EN61000-4-11:2004

14.3. Severity Levels and Performance Criterion

Severity Level:

Input and Output AC Power Ports.

- Voltage Dips.
- Voltage Interruptions.

Environmental Phenomena	Test Specification	Units	Performance Criterion
Voltage Dips	>95 0.5	% Reduction period	B
	30 25	% Reduction period	C
Voltage Interruptions	>95 250	% Reduction period	C

Performance criterion: B, C, C

- A. The apparatus shall continue to operate as intended during and after the test. No degradation of performance or loss of function is allowed below a performance level specified by the manufacturer, when the apparatus is used as intended.
- B. The apparatus shall continue to operate as intended after the test. No degradation of performance or loss of function is allowed below a performance level specified by the manufacturer, when the apparatus is used as intended. The performance level may be replaced by a permissible loss of performance. During the test, degradation of performance is however allowed.
- C. Temporary loss of function is allowed, provided the function is self-recoverable or can be restored by the operation of the controls.

14.4. EUT Configuration on Test

The configuration of EUT is the same as used in conducted emission test. Please refer to Section 2.7.

14.5. Operating Condition of EUT

Same as conducted emission test, which is listed in Section 2.7 except the test set up replaced as Section 14.1.

14.6. Test Procedure

- 1) Set up the EUT and test generator as shown on section 14.1
- 2) The interruption is introduced at selected phase angles with specified duration. There is a 3mins minimum interval between each test event.
- 3) After each test a full functional check is performed before the next test.
- 4) Repeat procedures 2 & 3 for voltage dips, only the level and duration is changed.
- 5) Record any degradation of performance.

14.7. Test Result

The product's power provide by DC, no requirement for this item.

A large, semi-transparent watermark of the BKC Testing Co., Ltd. logo is centered on the page, overlapping the text of section 14.7.

15. EUT PHOTOGRAPHS

EUT Photo 1

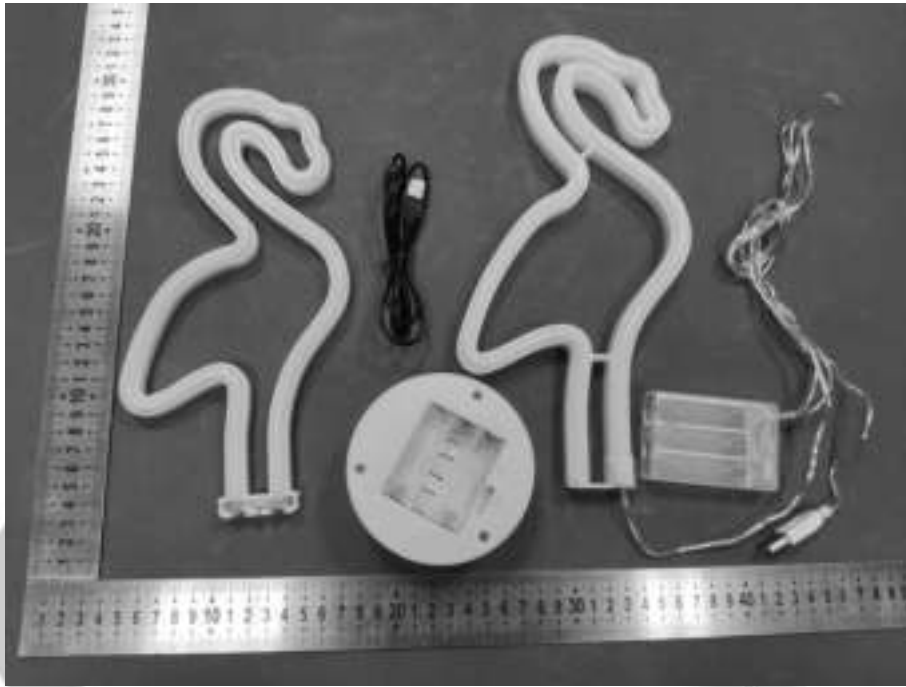

EUT Photo 2



EUT Photo 3

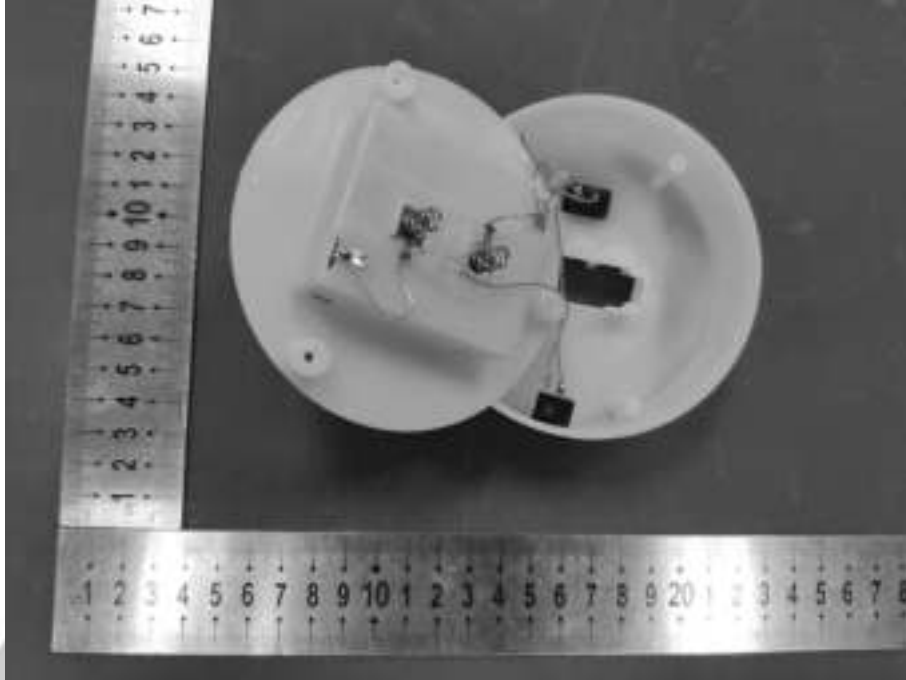

***** END OF REPORT *****