

ACCESSOIRES / ACCESSOIRES /
ACCESSORI / ACCESORIOS
Ref. No. 00153

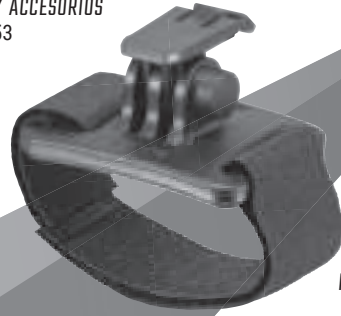

Helmhouderset
Kit Support pour casque
Kit supporto casco
Set de soporte del casco

ACCESSOIRES / ACCESSOIRES /
ACCESSORI / ACCESORIOS
Ref. No. 00150



Siliconenhouder
Support en silicone
Supporto in silicone
Soporte de silicona

ACCESSOIRES / ACCESSOIRES /
ACCESSORI / ACCESORIOS
Ref. No. 18460



USB-C-Kabel
Câble USB-C
Cavo USB-C
Cable USB-C

ACCESSOIRES / ACCESSOIRES /
ACCESSORI / ACCESORIOS
Ref. No. 00151



Schroefhouder
Support de recharge a visser
Supporto a vite
Soporte atornillado

ACCESSOIRES / ACCESSOIRES /
ACCESSORI / ACCESORIOS
Ref. No. 20501

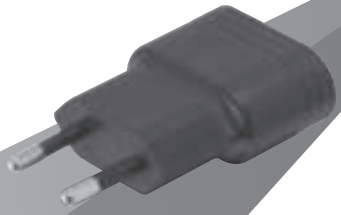

Oplader USB-C
Chargeur USB-C
Caricatore USB-C
Cargador USB-C

ACCESSOIRES / ACCESSOIRES /
ACCESSORI / ACCESORIOS
Ref. No. 00154



Action Camera adapter
Adaptateur pour Action Camera
Adattatore per Action Camera
Adaptador para Action Camera

FCC DECLARATION OF CONFORMITY



This device complies with Part 15 of the FCC Rules. Operation is subject to the following two conditions:
(1) This device may not cause harmful interference, and (2) This device must accept any interference received, including interference that may cause undesired operation. The grantee is not responsible for any changes or modifications not expressly approved by the party responsible for compliance. Such modifications could void the user's authority to operate the equipment. This equipment should be installed and operated with a minimum distance of 5 millimeters between the radiator and your body.

NOTE:
This equipment has been tested and found to comply with the limits for a Class B digital device, pursuant to part 15 of the FCC Rules. These limits are designed to provide reasonable protection against harmful interference in a residential installation. This equipment generates, uses and can radiate radio frequency energy and, if not installed and used in accordance with the instructions, may cause harmful interference to radio communications. However, there is no guarantee that interference will not occur in a particular installation. If this equipment does cause harmful interference to radio or television reception, which can be determined by turning the equipment off and on, the user is encouraged to try to correct the interference by one or more of the following measures:
- Reorient or relocate the receiving antenna.
- Increase the separation between the equipment and receiver.
- Connect the equipment into an outlet on a circuit different from that to which the receiver is connected.
- Consult the dealer or an experienced radio/TV technician for help.

FCC Caution:
Any changes or modifications not expressly approved by the party responsible for compliance could void the user's authority to operate this equipment.

Radiation Exposure Statement:
The product comply with the FCC portable RF exposure limit set forth for an uncontrolled environment and are safe for intended operation as described in this manual. The further RF exposure reduction can be achieved if the product can be kept as far as possible from the user body or set the device to lower output power if such function is available.

UKCA STATEMENT



We, SIGMA-ELEKTRO GmbH, declare that the equipment above has been tested in our facility and found compliance with the requirement limits of applicable standards, in accordance with the Radio Equipment Regulations 2017 and the Restriction of the Use of Certain Hazardous Substances in Electrical and Electronic Equipment Regulations 2012. The test record, data evaluation and Equipment Under Test (EUT) configurations represented herein are true and accurate under the standards herein specified.



CE INFORMATION

EN SIGMA-ELEKTRO GmbH hereby declares that the BUSTER 150 comply with the fundamental requirements and other relevant regulations of Directive 2014/30/EU and RoHS Directive 2011/65/EU. You can find the CE declaration at: ce.sigmasport.com/buster150
DE Hiermit erklärt SIGMA-ELEKTRO GmbH, dass sich die BUSTER 150 in Übereinstimmung mit den grundlegenden Anforderungen und den anderen relevanten Vorschriften der Richtlinie 2014/30/EU und RoHS Directive 2011/65/EU befinden. Sie finden die Konformitäts-Erklärung unter folgendem Link: ce.sigmasport.com/buster150
FR Vous trouverez la déclaration CE à l'adresse : ce.sigmasport.com/buster150
IT La dichiarazione CE è disponibile all'indirizzo: ce.sigmasport.com/buster150
ES Puede encontrar la declaración de conformidad CE en: ce.sigmasport.com/buster150
NL U kunt de CE-certificering vinden op: ce.sigmasport.com/buster150

WAARSCHUWING / AVERTISSEMENT / AVVERTENZA / ADVERTENCIA !

NL Mogelijk gevaarlijke optische straling! Kijk bij gebruik nooit direct in de lamp of richt deze nooit op de ogen van andere personen.
FR Le rayonnement émis peut être dangereux ! Ne jamais regarder l'éclairage pendant son fonctionnement et ne jamais l'orienter dans les yeux d'autres personnes.
IT Radiazioni ottiche potenzialmente pericolose! Non guardare mai direttamente nel fanale quando è in funzione o non puntarlo mai sugli occhi di altre persone.
ES ¡Riesgo de radiación nociva! Nunca mires directamente al faro encendido, ni lo orientes hacia los ojos de otras personas.



MONTAGE / MONTAGE / MONTAGGIO / MONTAJE

SILICONENHOUDER / SUPPORT EN SILICONE / SUPPORTO IN SILICONE / SOPORTE DE SILICONA

NL Stel de BUSTER 150 zo in dat andere verkeersdeelnemers niet worden verblind. De BUSTER 150 moet vast met de fiets verbonden zijn en de lichtbundel mag niet bedekt zijn.
FR Réglez le BUSTER 150 de manière à ne pas éblouir les autres usagers. Le BUSTER 150 doit être solidement fixé au vélo et le faisceau lumineux ne doit pas être obstrué.
IT Posizionate la BUSTER 150 in modo da non abbagliare gli altri utenti della strada. La BUSTER 150 deve essere saldamente fissata alla bici e la luce non essere coperta.
ES Ajusta el BUSTER 150 de manera que no deslumbré a otros usuarios de la vía. El BUSTER 150 debe estar firmemente fijado a la bicicleta y el haz de luz debe proyectarse sin obstáculos.

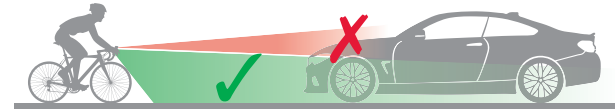
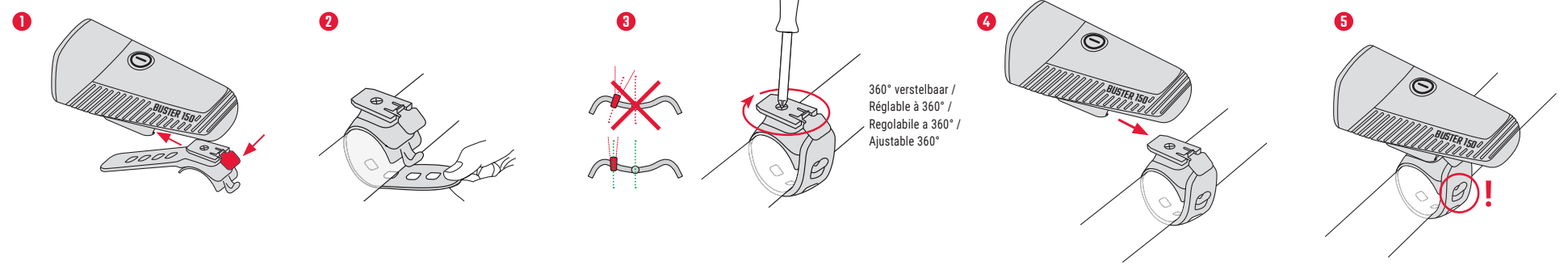

DO YOU ALSO KNOW OUR BIKE COMPUTERS?

More SIGMA Bike Computers at sigmasport.com



SIGMA-ELEKTRO GmbH
Dr. -Julius-Leber-Straße 15
67433 Neustadt / Weinstraße
Germany
Tel. +49 6321-9120-118
kundenservice@sigmasport.com



Designed in Germany
Manufactured in China

VIDEO TUTORIALS

Gedetailleerde tutorials en gebruikstips kun je vinden onder deze link.

Vous trouverez des tutoriels détaillés et des astuces d'utilisation sous ce lien.

Tutorial dettagliati e consigli per l'uso sono disponibili a questo link.

En este enlace encontrarás tutoriales detallados y consejos de uso.

goto.sigmasport.com/buster150/service



5 MODI / 5 MODES / 5 MODALITÀ / 5 MODOS

KNOP BOUTON PULSANTE BOTÓN	MODUS MODE MODALITÀ MODOS	LUMEN LUMEN LÚMENES	BRANDDUUR AUTONOMIE DURATA DURACIÓN
2 x short click	AAN / Laatste modus ON / Dernier mode ON / Ultima Modalità ON / Último modo		
+ 1 x click	HIGH	≤ 150	≤ 3 h
+ 1 x click	MID	≤ 75	≤ 7,5 h
+ 1 x click	LOW	≤ 35	≤ 14,5 h
+ 1 x click	NIGHT FLASHING	≤ 100/40	≤ 5 h
+ 1 x click	DAY FLASHING	≤ 40	≤ 25 h
+ 1 x click			
1 x long click 2 sec. → OFF			

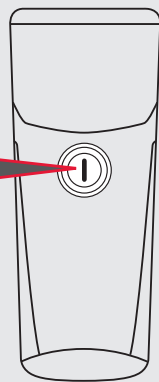

LICHT-MODUS GEHEUGENFUNCTIE / FONCTION MÉMOIRE DE MODE / FUNZIONE MODE MEMORY / FUNCIÓN DE MODO DE MEMORIA



VOORBEELD / EXEMPLE / ESEMPIO / EJEMPLO

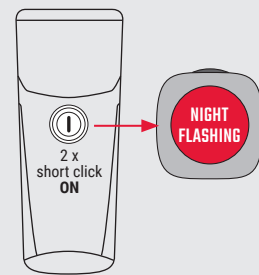

NL Bij het uitschakelen van de BUSTER 150 blijft de laatst gebruikte modus behouden.
FR Le dernier mode utilisé est conservé après l'arrêt du BUSTER 150.
IT Quando si spegne la BUSTER 150 viene memorizzata l'ultima modalità utilizzata.
ES Al apagar el BUSTER 150 se mantiene el modo utilizado por última vez.

VOORINGESTELDE LICHT-PROFIELEN / PROFILS DE MODE PRÉRÉGLÉS / PROFILI MODALITÀ PREIMPOSTATI / PERFILES DE MODOS PREAJUSTADOS

NL PROFIELELECTIE:

Je kunt jouw BUSTER 150 individueel aan jouw geprefereerde lichtmodi instellen. Hiervoor beschikt de lamp over 5 verschillende profielen welke je als volgt kunt selecteren. Houd de ON/OFF knop in (lamp moet uitgeschakeld zijn) ca. 5 sec ingedrukt, dan kom je in de 'profielselectie'. De lamp knippert 1 maal voor profiel 1, 2 maal voor profiel 2, etc. Druk om het gewenste profiel te selecteren 1 x op de ON/OFF knop als jouw gewenste profiel voorbij komt. Jouw keuze wordt bevestigd door het vier maal kort oplichten van de voorste LED.

FR SÉLECTION DU PROFIL :

Vous pouvez adapter votre BUSTER 150 en fonction de vos exigences. L'éclairage est doté de 5 profils différents pouvant être sélectionnés de la façon suivante. Maintenez le bouton ON/OFF enfoncé pendant plus de 5 sec. lorsque l'éclairage est éteint pour accéder à la sélection du profil. L'éclairage clignote 1x pour le profil 1, 2x pour le profil 2 et ainsi de suite. Appuyez ensuite 1x sur le bouton ON/OFF pour sélectionner le profil souhaité. Votre sélection est alors confirmée par quatre clignotements brefs de l'éclairage.

IT SELEZIONE DEL PROFILO:

Potete modificare individualmente la BUSTER 150 in base alle vostre esigenze. La luce dispone infatti di 5 profili diversi che potete selezionare come di seguito. Tenete premuto il pulsante ON/OFF a fanale spento per più di 5 sec., fino ad arrivare alla selezione del profilo. Il fanale lampeggia 1 volta per il profilo 1, 2 volte per il profilo 2 ecc. Per selezionare il profilo desiderato premere il pulsante ON/OFF 1x. La vostra selezione viene confermata dal LED anteriore che si illumina brevemente per quattro volte.

ES SELECCIÓN DEL PERFIL:

Puedes adaptar el BUSTER 150 a tus necesidades. Para ello, el faro dispone de 5 perfiles diferentes que puedes seleccionar de la siguiente manera: Mantén pulsado el botón ON/OFF durante más de 5 segundos con el faro apagado para acceder a la selección de perfiles. El faro parpadeará 1 vez para el perfil 1, 2 veces para el perfil 2 y así sucesivamente. Para seleccionar el perfil deseado, pulsa una vez el botón ON/OFF. La selección queda confirmada al encenderse el LED frontal, que se enciende brevemente cuatro veces.

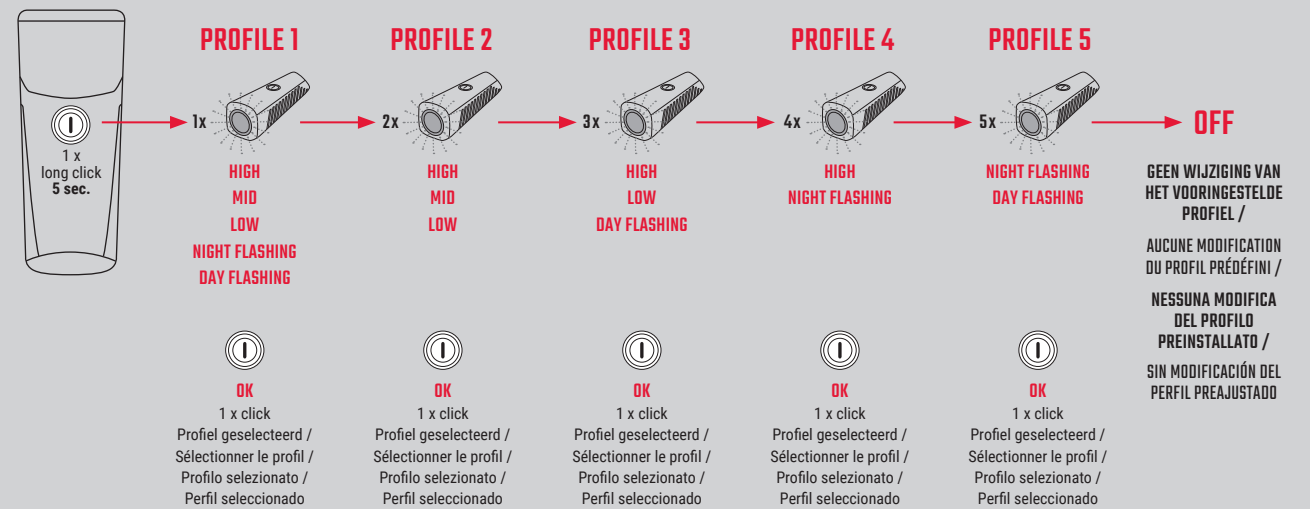

ACCU-INDICATOR / TÉMOIN DE LA BATTERIE / INDICATORE BATTERIA / INDICADOR DE BATERÍA

NL ACCUSTATUS:

Door één keer kort klikken in uitgeschakelde toestand wordt de actuele laadtoestand van de accu weergegeven.

FR ÉTAT DE LA BATTERIE :

L'état actuel de la batterie peut être affiché en faisant un clic court sur le bouton pendant que l'éclairage est éteint.

IT STATO BATTERIA:

A fanale spento 1 breve clic mostra lo stato attuale della batteria.

ES ESTADO DE LA BATERÍA:

Cuando está apagado, 1 breve click muestra el estado actual de la batería.

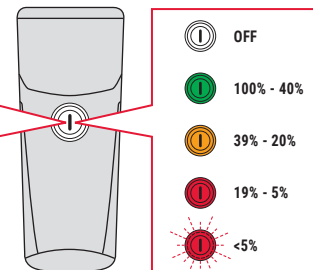

NL OPMERKING:

Bij minder dan 20% accucapaciteit gaat de rode indicator-LED branden en na circa 45 minuten knippert de rode led. Kort daarna schakelt de BUSTER 150 helemaal uit.

FR REMARQUE :

Lorsque la capacité de la batterie est inférieure à 20 %, le témoin LED rouge s'allume et, après environ 45 minutes, il commence à clignoter, puis le BUSTER 150 s'éteint complètement peu après.

IT NOTA:

In caso di capacità della batteria inferiore al 20% l'indicatore a LED rosso si illumina e dopo circa 45 min. il LED rosso lampeggia. In breve tempo la BUSTER 150 si spegnerà completamente.

ES OBSERVACIÓN:

Si a la batería le queda menos del 20 %, se enciende el indicador LED rojo y, después de aprox. 45 minutos, este LED rojo empieza a parpadear. Poco después, el BUSTER 150 se apaga por completo.

LAADPROCEDURE / PROCESSUS DE CHARGEMENT / PROCESSO DI CARICA / PROCESO DE CARGA

NL Laad de lamp alleen op kamertemperatuur op.

(Laadtemperatuur: +10 °C tot +45 °C)
Let er op dat de rood gemarkeerde afdichting na het laden altijd goed is afgesloten.
Stroomafname via de USB-C aansluiting is niet mogelijk.

FR Chargez la lampe uniquement à température ambiante.

(Température de charge : +10 °C à +45 °C)
Veillez à ce que le cache USB-C étanche indiqué ici en rouge soit correctement refermé après le chargement.
Aucune énergie ne peut être transférée vers l'extérieur par la connexion USB-C.

IT Caricare la lampada solo a temperatura ambiente.

(Temperatura di carica: da +10 °C a +45 °C)
Assicuratevi che la sigillatura contrassegnata in rosso sia sempre chiusa correttamente dopo il processo di ricarica.
Non può essere utilizzata come power bank.

ES Solo cargue la lámpara a temperatura ambiente.

(Temperatura de carga: +10 °C a +45 °C)
Por favor, asegúrate de que el elemento sellante marcado en rojo esté siempre correctamente cerrado después de completar la carga.
No es posible extraer energía del faro usando el puerto USB-C.

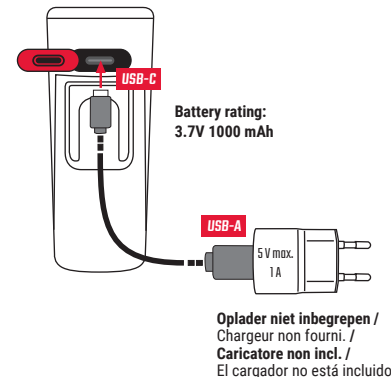

OPLAADINDICATOR / INDICATEUR DU NIVEAU DE CHARGE / INDICATORE DI CARICA / INDICADOR DE CARGA

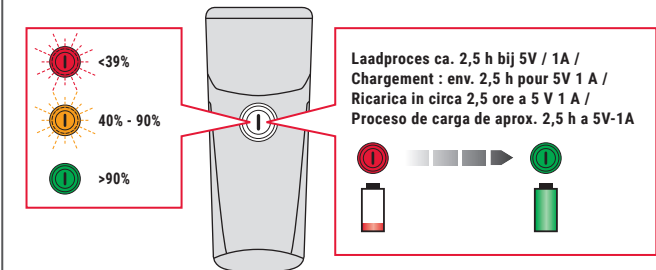

Laadproces ca. 2,5 h bij 5V / 1A /
Chargement : env. 2,5 h pour 5V 1 A /
Ricarica in circa 2,5 ore a 5 V 1 A /
Proceso de carga de aprox. 2,5 h a 5V-1A

TECHNISCHE GEGEVENS / DONNÉES TECHNIQUES / DATI TECNICI / ESPECIFICACIONES TÉCNICAS

NL	FR	IT	ES
Laadtemperatuur: +10°C tot +45°C	Température de chargement : +10 °C à +45 °C	Temperatura di carica: da +10 °C a +45 °C	Temperatura de carga: +10°C hasta +45°C
Accutype: 3,7V, 1000 mAh	Type de batterie : 3,7 V, 1000 mAh	Tipo di batteria: 3,7 V, 1000 mAh	Tipo de batería: 3,7 V, 1000 mAh
Max. vermogen: 3 W	Puissance max. : 3 W	Potenza max.: 3 W	Potencia máx.: 3 W
Beschermingsklasse water- en stofdichtheid: IP44	Classe de protection contre l'eau et la poussière : IP44	Classe di protezione acqua e polvere: IP44	Nivel de protección para agua y polvo: IP44