

Getting started with
reMarkable

Get started 

Contents

1. Gestures

1.1 Navigating by touch

1.2 Long-press

2. Organizing and sharing

2.1 My files

2.2 Folders

2.3 Favorites

2.4 Moving files and folders

2.5 Deleting files and folders

2.6 Trash

2.7 Settings

2.8 Transferring files to your reMarkable

2.9 Syncing files

2.10 Sharing via email

2.11 LiveView

3. Page management

- 3.1 Page orientation
- 3.2 Page management
- 3.3 Adding pages
- 3.4 Moving and reordering pages
- 3.5 Duplicating pages
- 3.6 Deleting pages

4. Notetaking and sketching

- 4.1 Finding your favorite pen
- 4.2 Erasers
- 4.3 Quick sheets
- 4.4 Adjusting the toolbar menu
- 4.5 Templates
- 4.6 Handwriting conversion
- 4.7 Layers
- 4.8 Selection tool (copy, paste, and other functions)

5. Reading

- 5.1 Text settings for ebooks
- 5.2 Highlighter tool
- 5.3 Cropping documents

Gestures

1.1 Navigating by touch

1.2 Long-press

1.1 Navigating by touch

You can navigate within documents and notebooks using gestures.

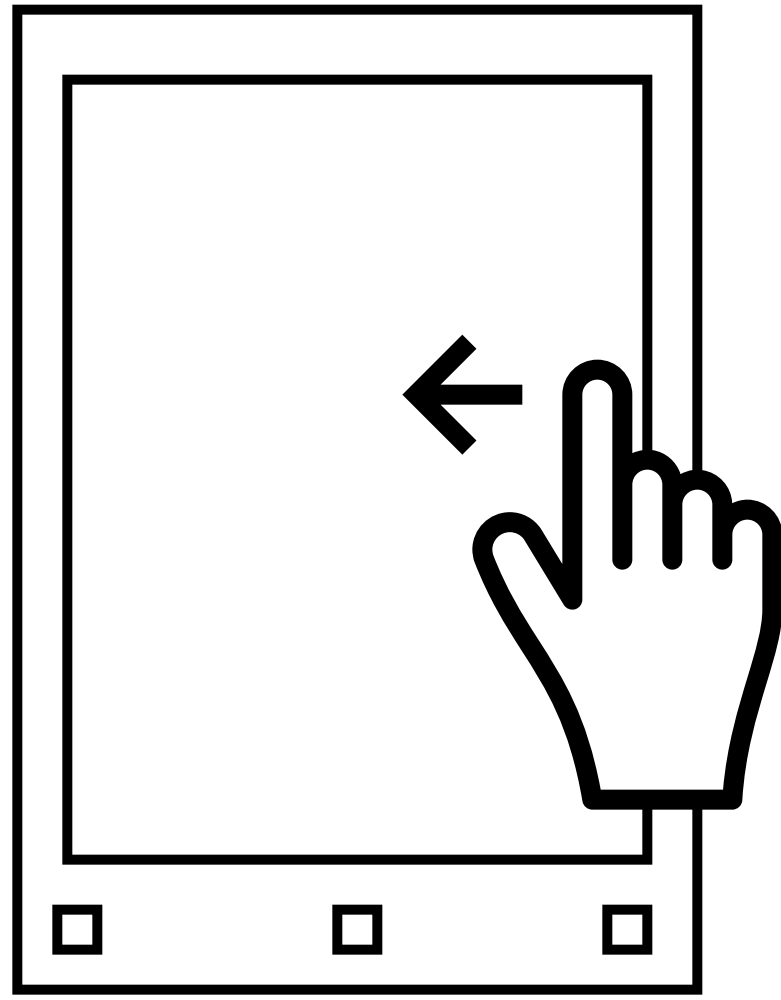

Swipe left to go to the next page, or to add a new page if you are on the last page of your notebook.

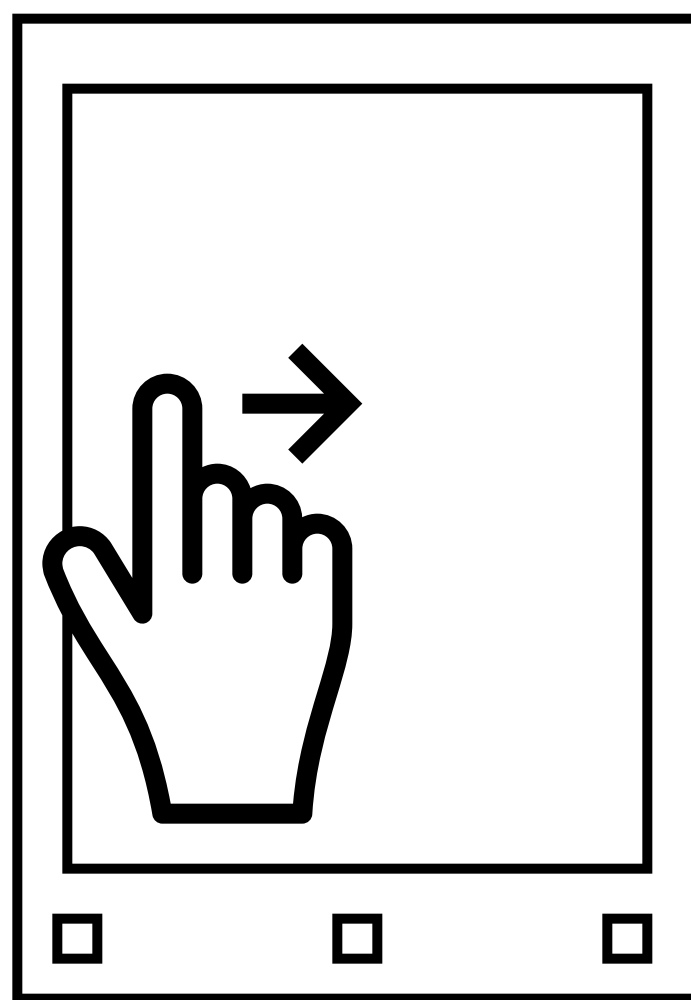

Swipe right to go to the previous page.

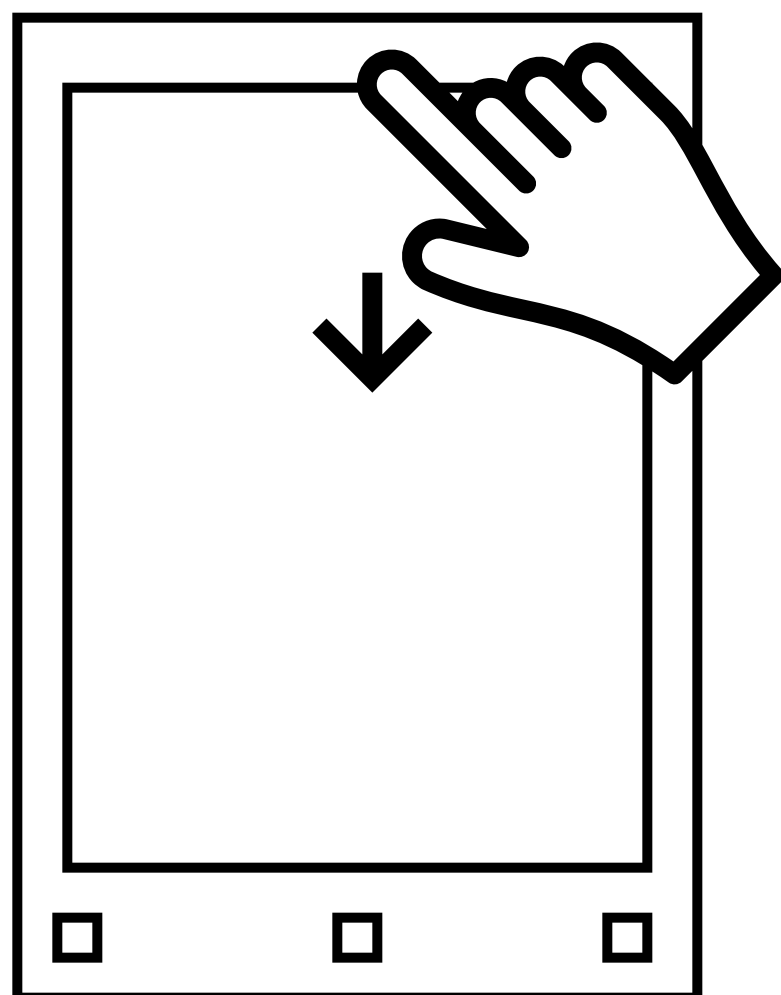

Swipe down to close the document.

1.2 Long-press

To edit or share a folder, document, page, or notebook, simply hold your Marker or finger on it for a few seconds, and the required action bar will appear above. The same rule applies for editing the names of layers.

Long-press

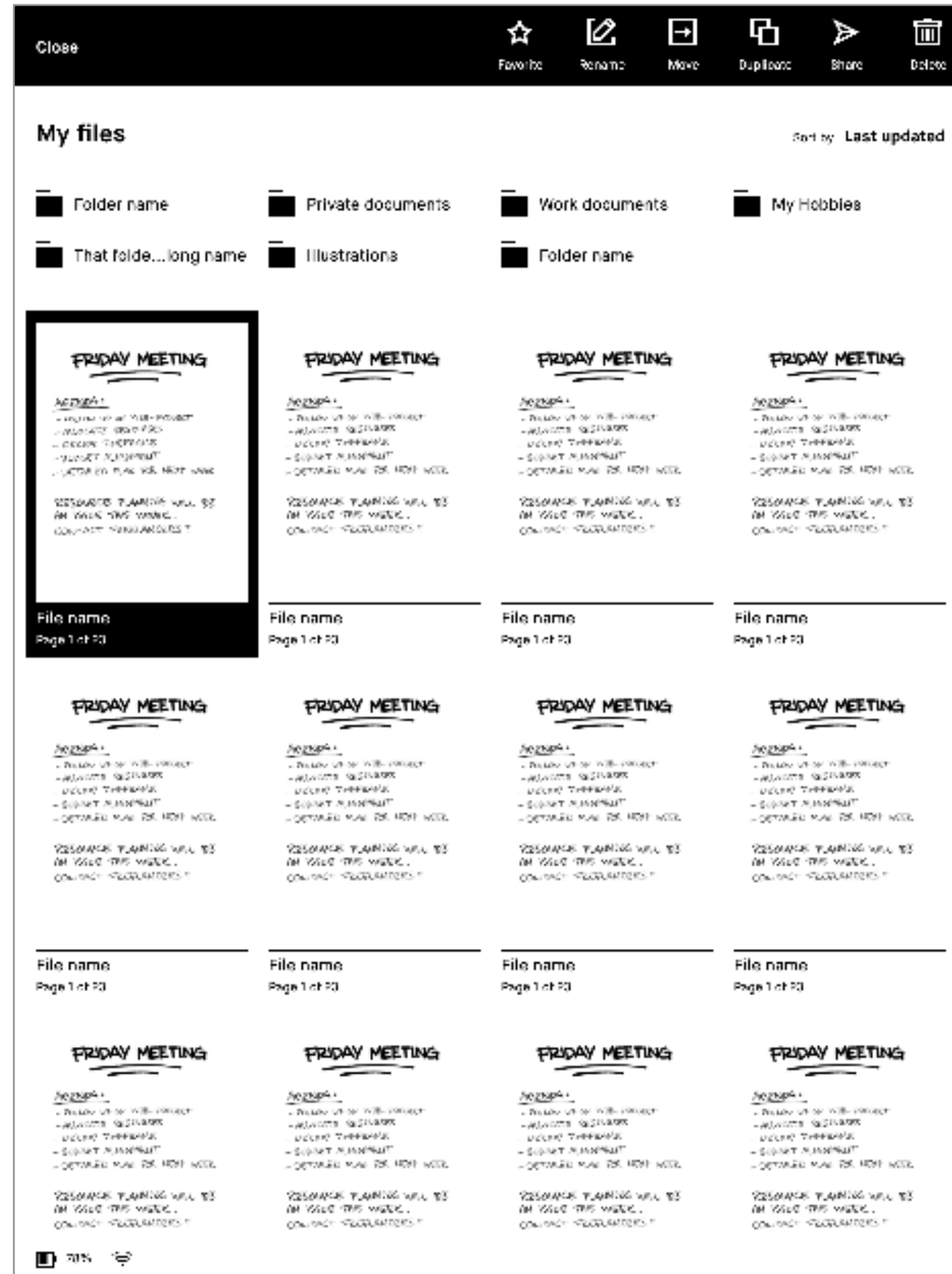
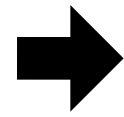
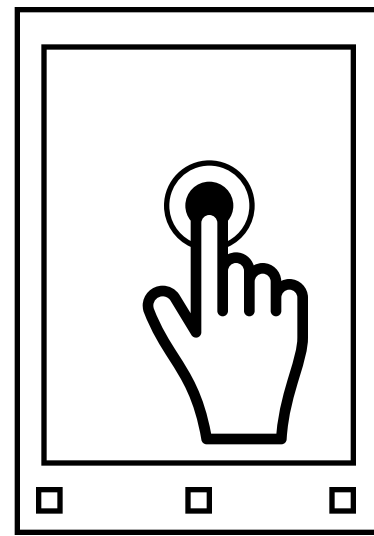

To select additional files, folders, or pages simply tap them.

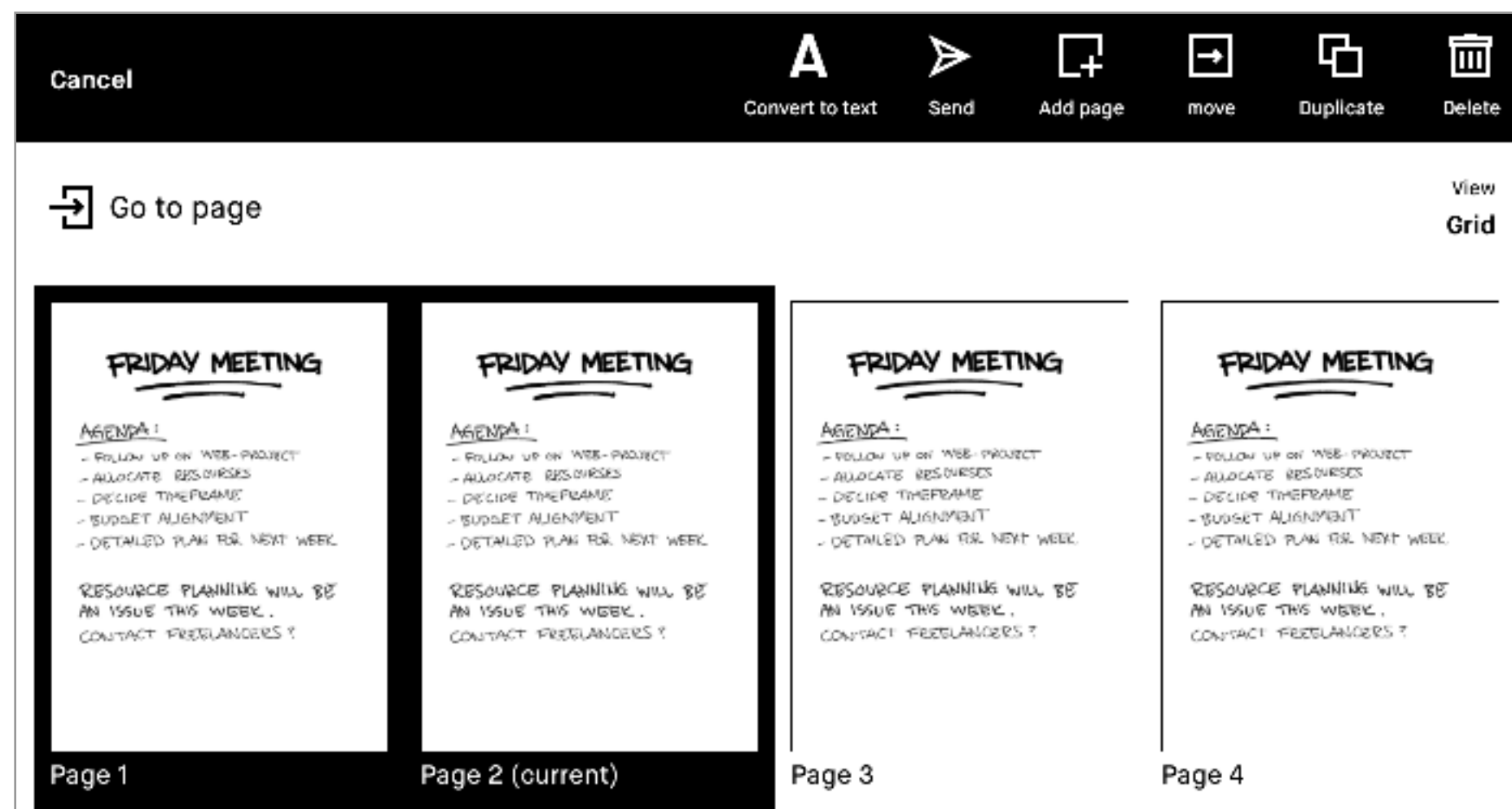

Organizing and sharing

- 2.1 My files
- 2.2 Folders
- 2.3 Favorites
- 2.4 Moving files and folders
- 2.5 Deleting files and folders
- 2.6 Settings
- 2.7 Transferring files to your reMarkable
- 2.8 Syncing files
- 2.9 Sharing via email
- 2.10 LiveView

2.1 My files

My files

Provides an overview of all the files on your reMarkable, and allows you to organize your notebooks, PDFs, and ebooks according to your needs. Here you can also add, move, rename, and delete folders. To show **My files**, just tap **Menu**, then **My files**.

Create new

At the top of your screen, you can create new folders, notebooks, and quick sheets.

File order

Tap **Sort by** to arrange your files by last updated, by size, or alphabetically.

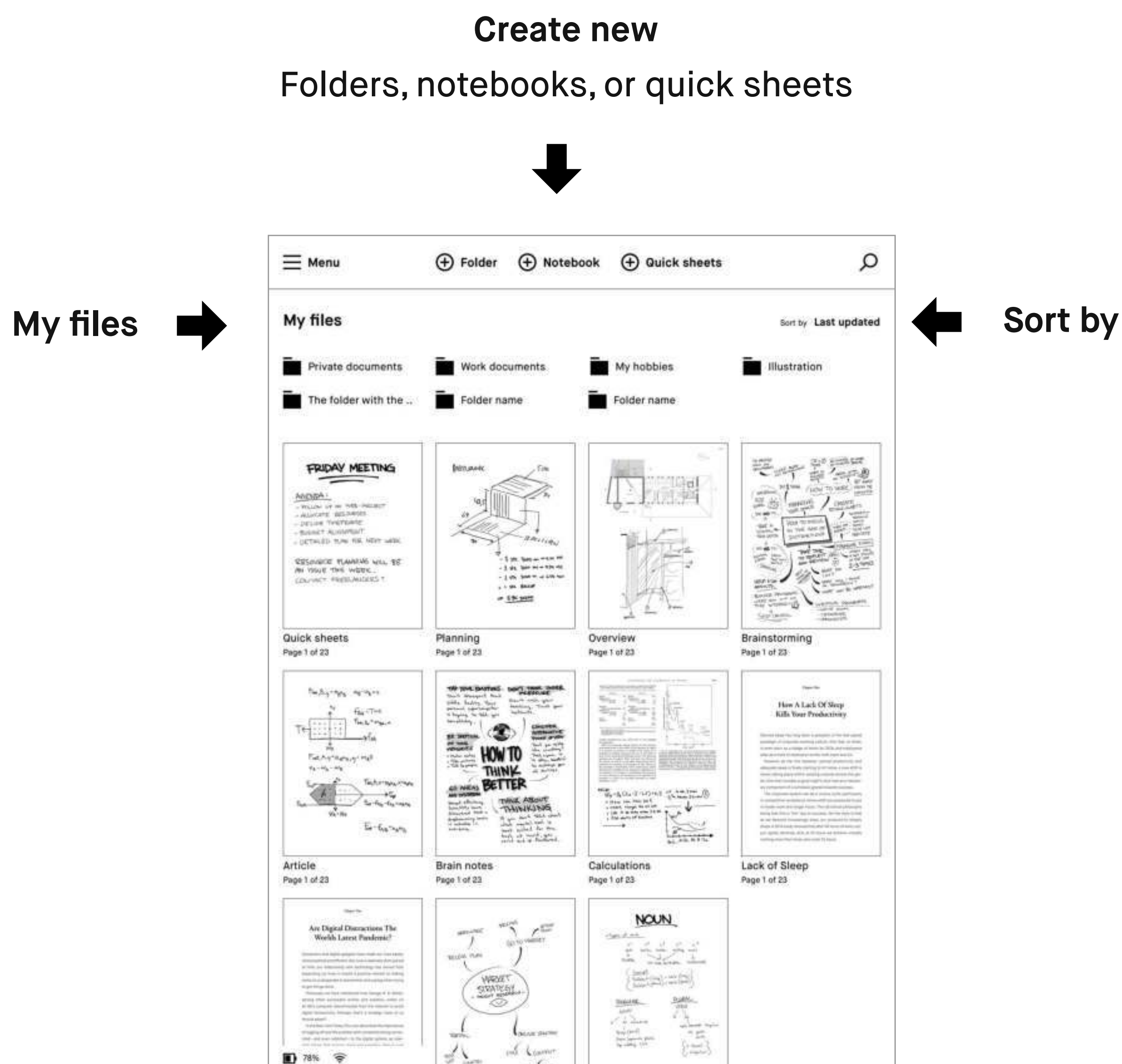

Menu

Tapping **Menu** in the top left corner reveals the sidebar menu and gives you the option to filter by **Notebooks**, **PDFs**, **Ebooks**, **Favorites**, or **Trash**. The sidebar menu is also home for your reMarkable's settings, and view options.

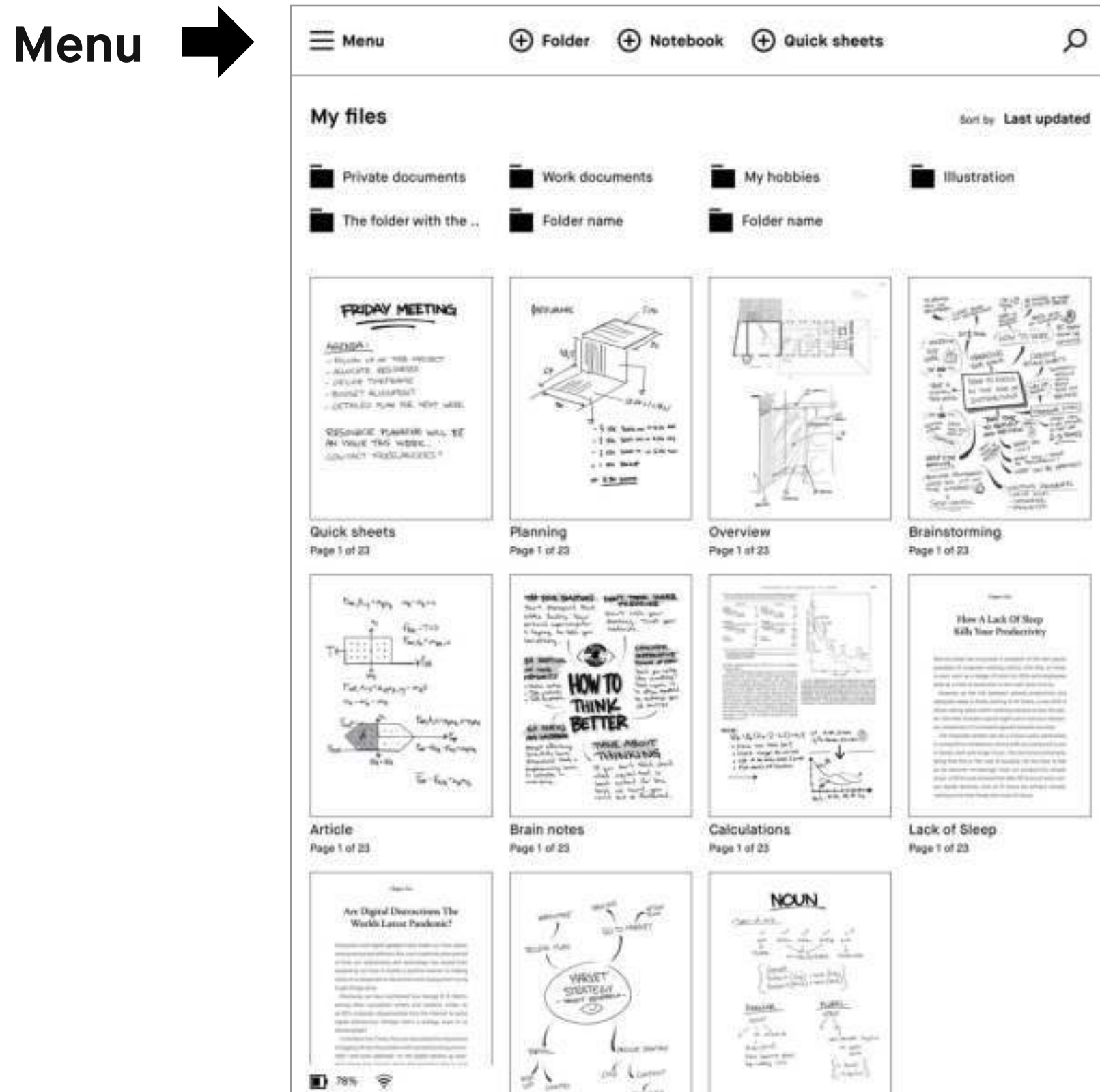

Filters

Tapping **Notebooks**, **PDFs**, **Ebooks**, or **Favourites**, in the sidebar menu will filter your content to reflect your selection. To reset, or go back to viewing all files, simply tap **My files**.

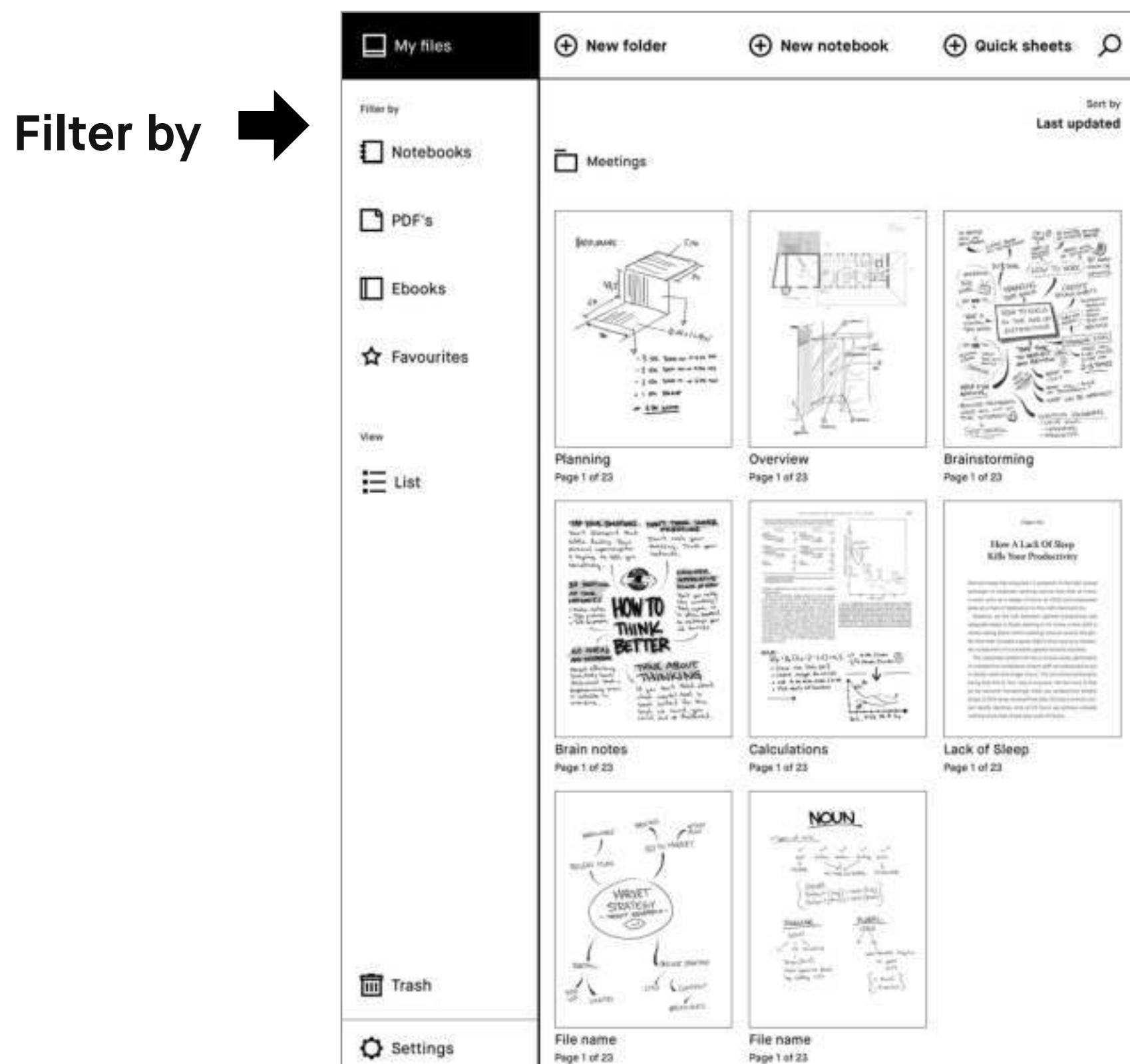

2.2 Folders

You can organize your notebooks, documents, and ebooks into folders. Define your file structure using folders and subfolders under **My files**.



+ Folder

New folders can be created from the My files screen, by tapping the create folder icon found in the middle of the top bar.

2.3 Favorites

Use favorites to label notebooks, documents, or ebooks that you want quick access to. All your favorites are collected in **My files** under Favorites.

To favourite a file, **long-press** the item you want and then tap on the star.

Tap on star

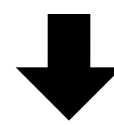

Long-press →

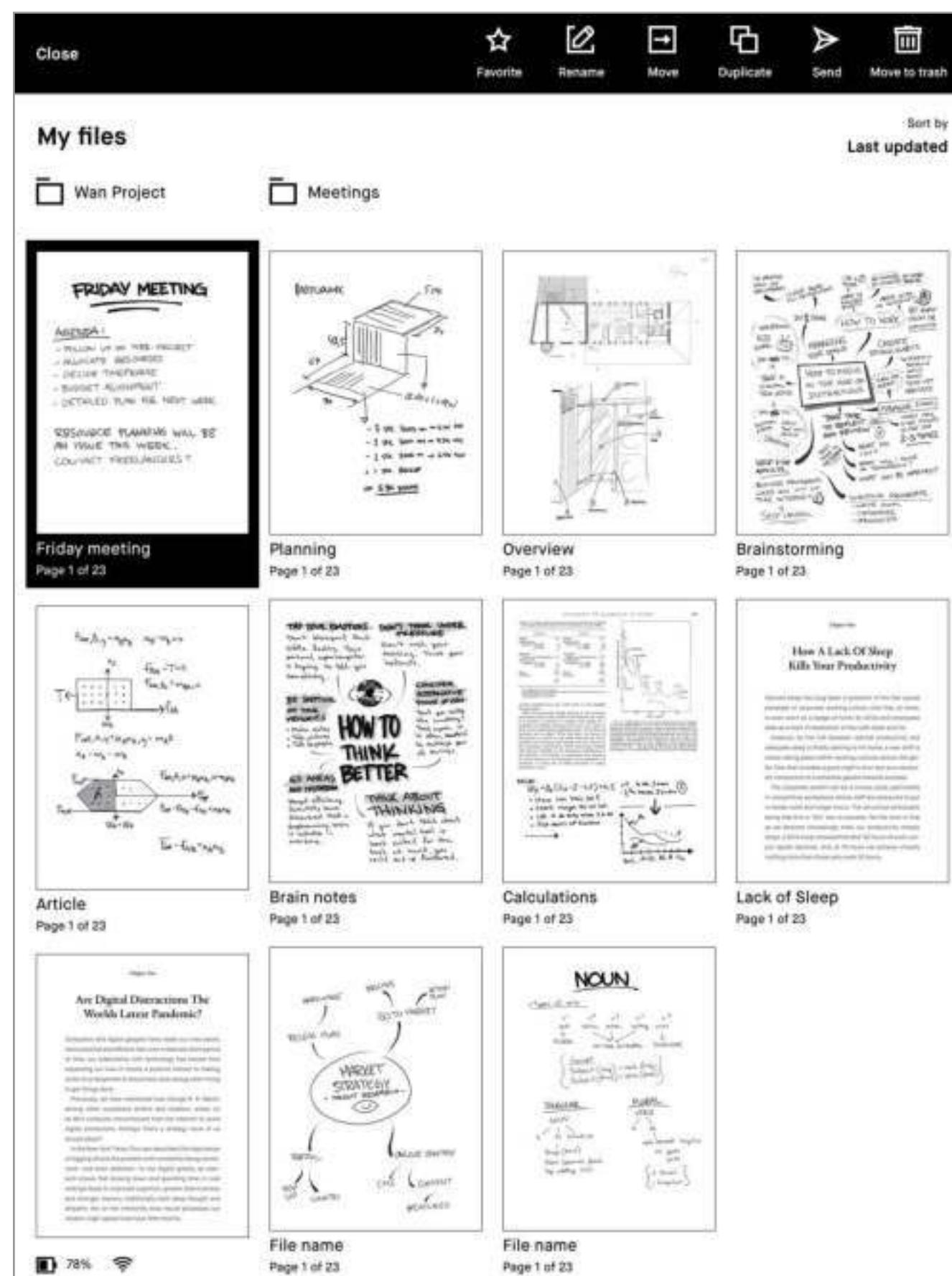

2.4 Moving files and folders

1. Open My files or a folder.
2. Long-press the item you would like to move. Select multiple items by tapping.
3. Tap **Move** in the action bar.

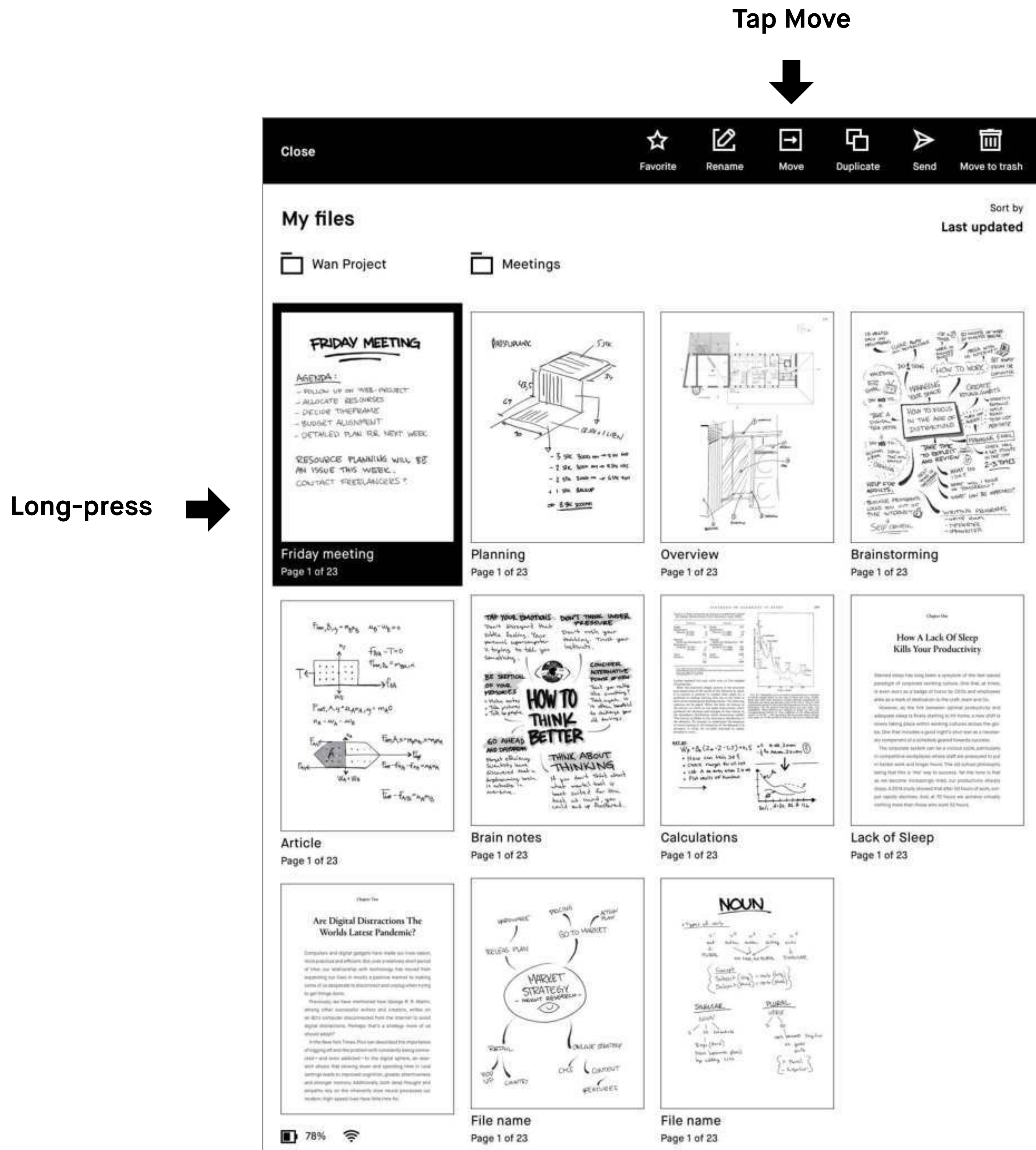

4. Choose your destination by selecting a folder.
5. Confirm the action by tapping **Move here**.

Cancel

Select where to place the page



Move here

2.5 Deleting files and folders

Before files or folders can be permanently deleted, they need to be moved to trash first. This does not apply to pages within notebooks, which are instantly deleted. It's possible to restore files that have been moved to the trash if you change your mind.

1. Long-press the item you want to delete.
2. Tap Move to trash in the action bar.

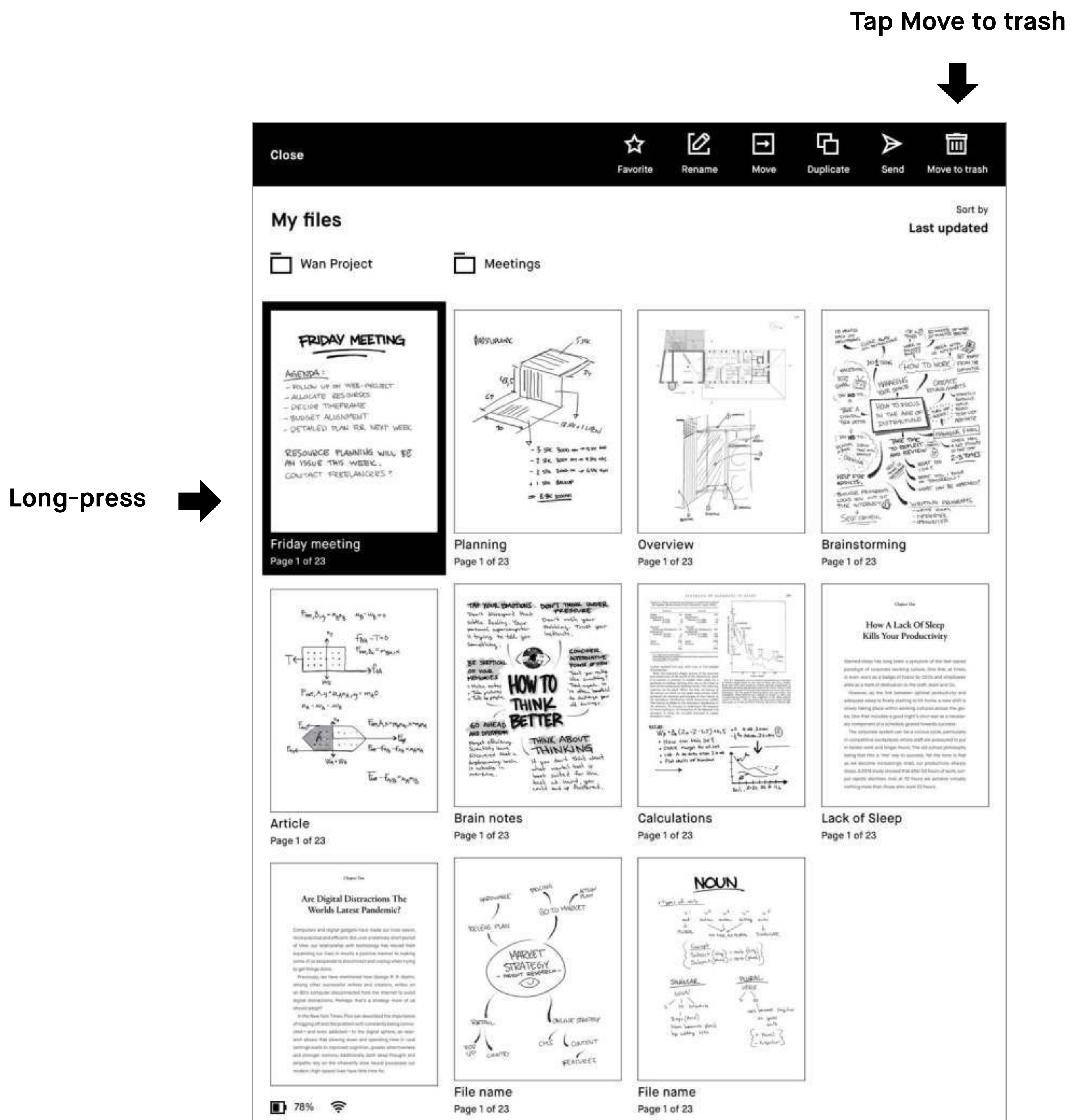

Note The deletion process can be canceled by tapping undo on the notification that appears at the bottom of the screen.

2.6 Trash

Deleted files and folders are found in Trash, which is located in the sidebar menu towards the bottom. To permanently delete all files and folders currently in the trash, tap **Empty trash**.

Tap to permanently delete all

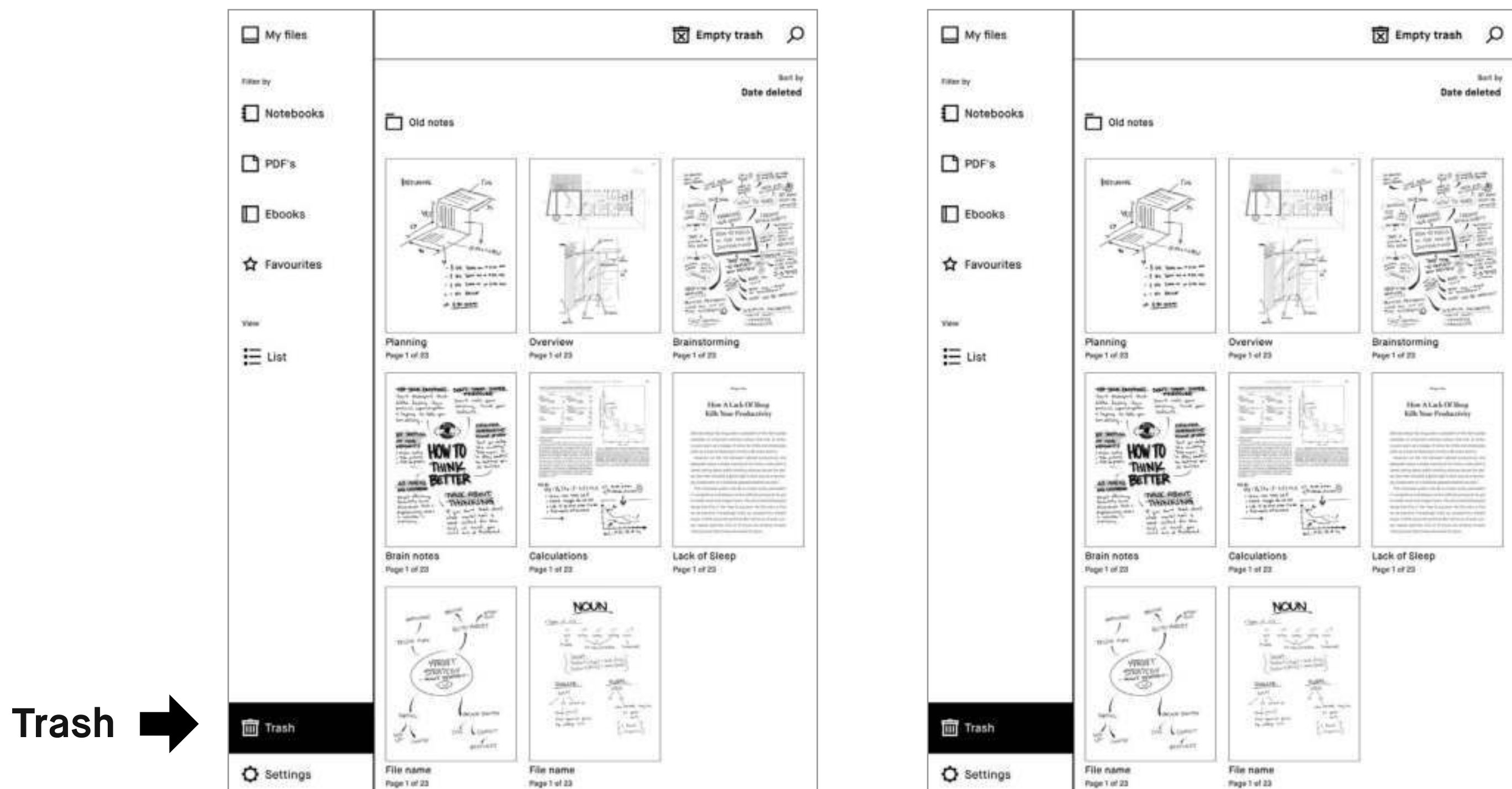
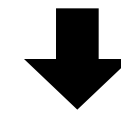

Long-pressing files or folders in the trash will give you the option to either restore or delete permanently.

Tap to restore

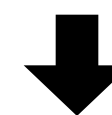

Tap to delete permanently



2.6 Settings

Tap **Settings** in the bottom left-hand corner, to bring up the settings menu.

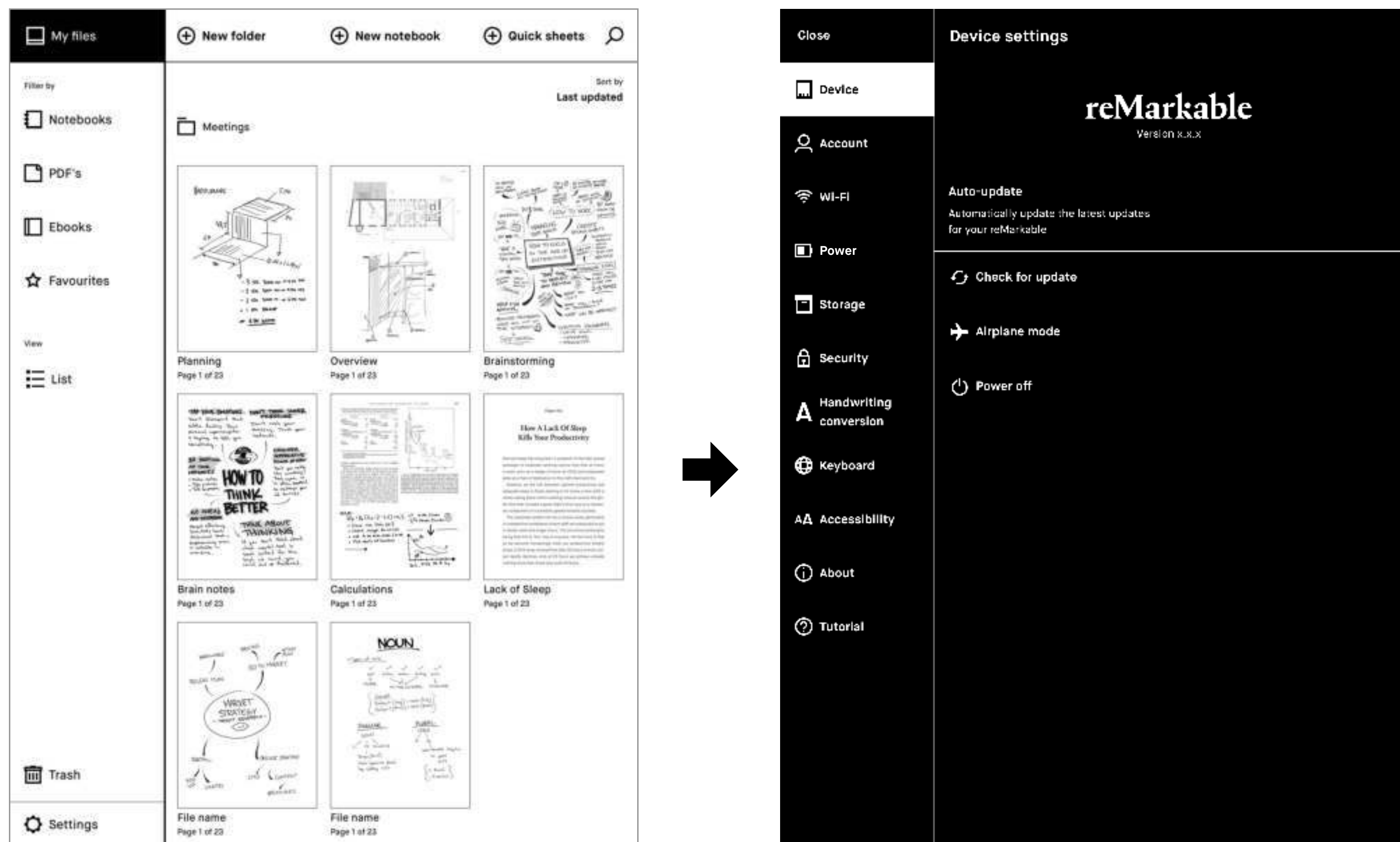

↑
Settings

Device settings enables you to turn auto-update on/off and download the latest software.

Account settings is where you log in to your account to transfer files between your connected apps.

Wi-Fi settings is where you connect to Wi-Fi.

Power settings informs you of your battery status.

Storage settings gives an overview of how much free space is left on your reMarkable.

Security settings enables you to set a passcode to protect your files.

Keyboard settings is where you choose your keyboard language.

Accessibility settings lets you alter between left, and right-handed mode, and modify text size to suit your needs

2.7 Transferring files to your reMarkable

Use the **desktop or mobile app** to import PDFs and ebooks onto your reMarkable. Once imported, your files will be synced across your connected devices.

Note reMarkable supports the following file formats: PDF and ePUB (DRM-free)

Importing files using the desktop app

The desktop app is available for Mac OS and Windows 7 or newer. Download it at my.remarkable.com

Drag and drop files directly into the app.

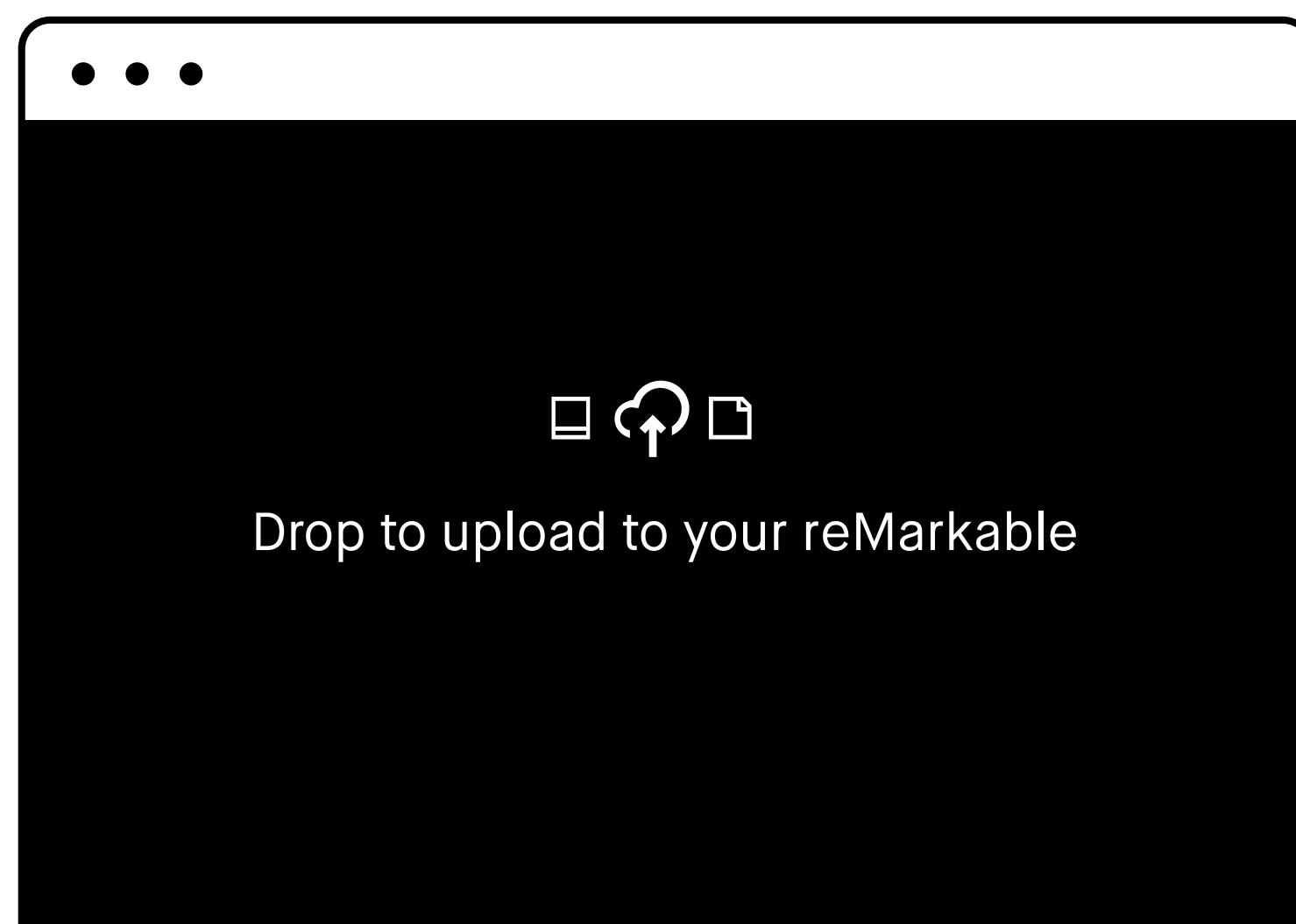

Importing files using the mobile app

The **reMarkable** app is available for iOS and Android. Download it at my.remarkable.com, or from Google Play or the App Store.

iOS app

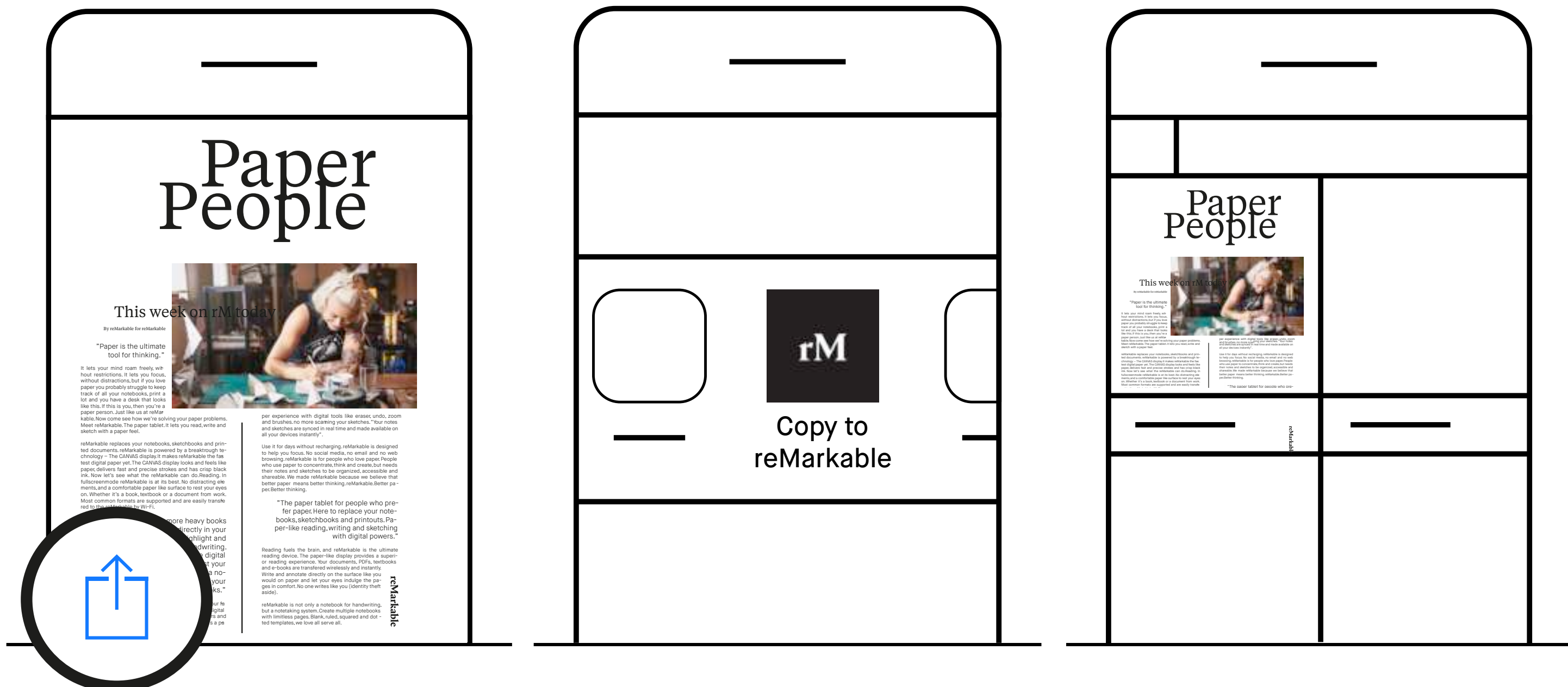

1. Open the file you want to import and tap the **Share** icon.

2. Select **Import with** or **Copy to reMarkable**.

3. The file can now be found in the mobile app and on your reMarkable.

Android app

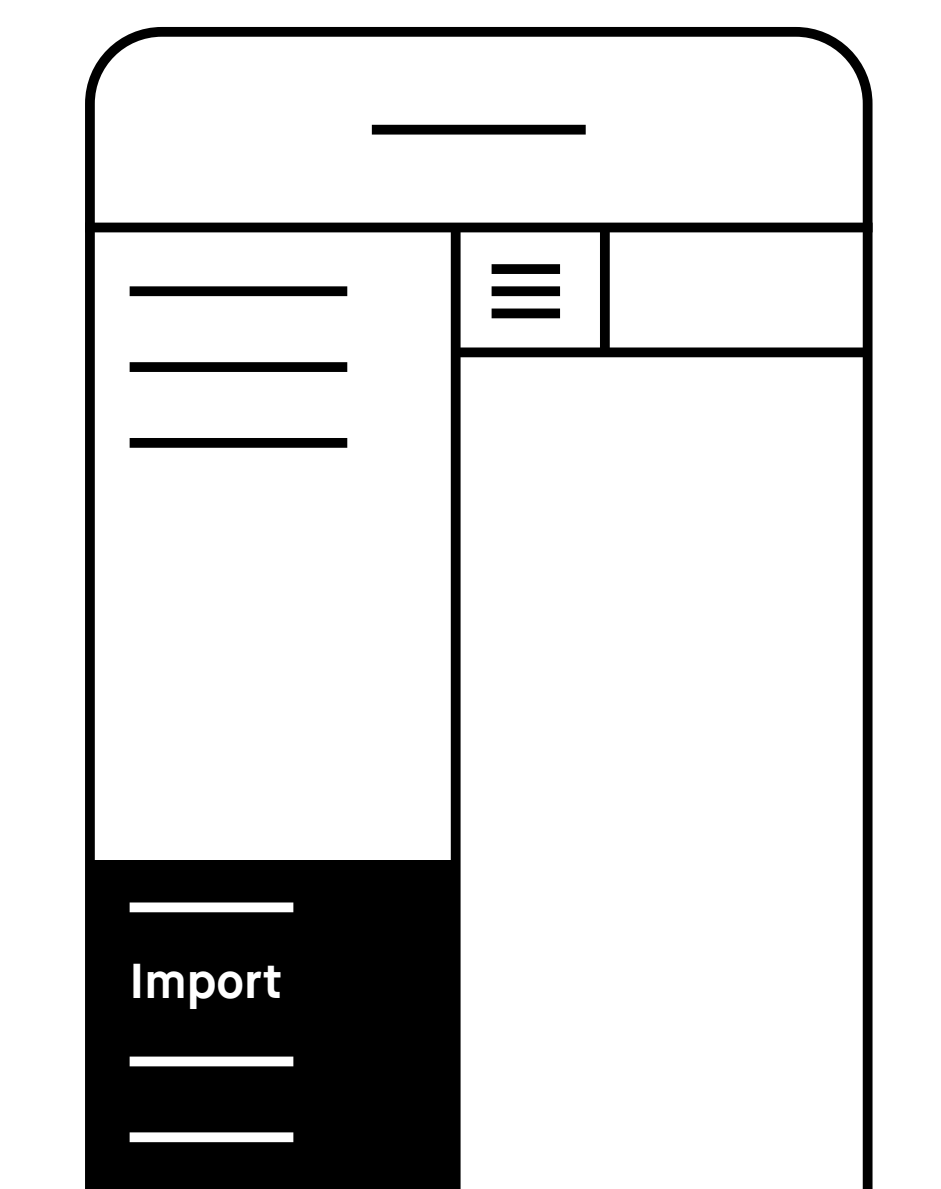

You can also import files directly from the Android app. Simply tap the menu and select **Import**.

2.8 Syncing files

Once imported, your files will be synced across all devices (app, desktop, and your reMarkable). A progress bar monitors sync progress, while there's a check sync option for diagnosing sync issues.

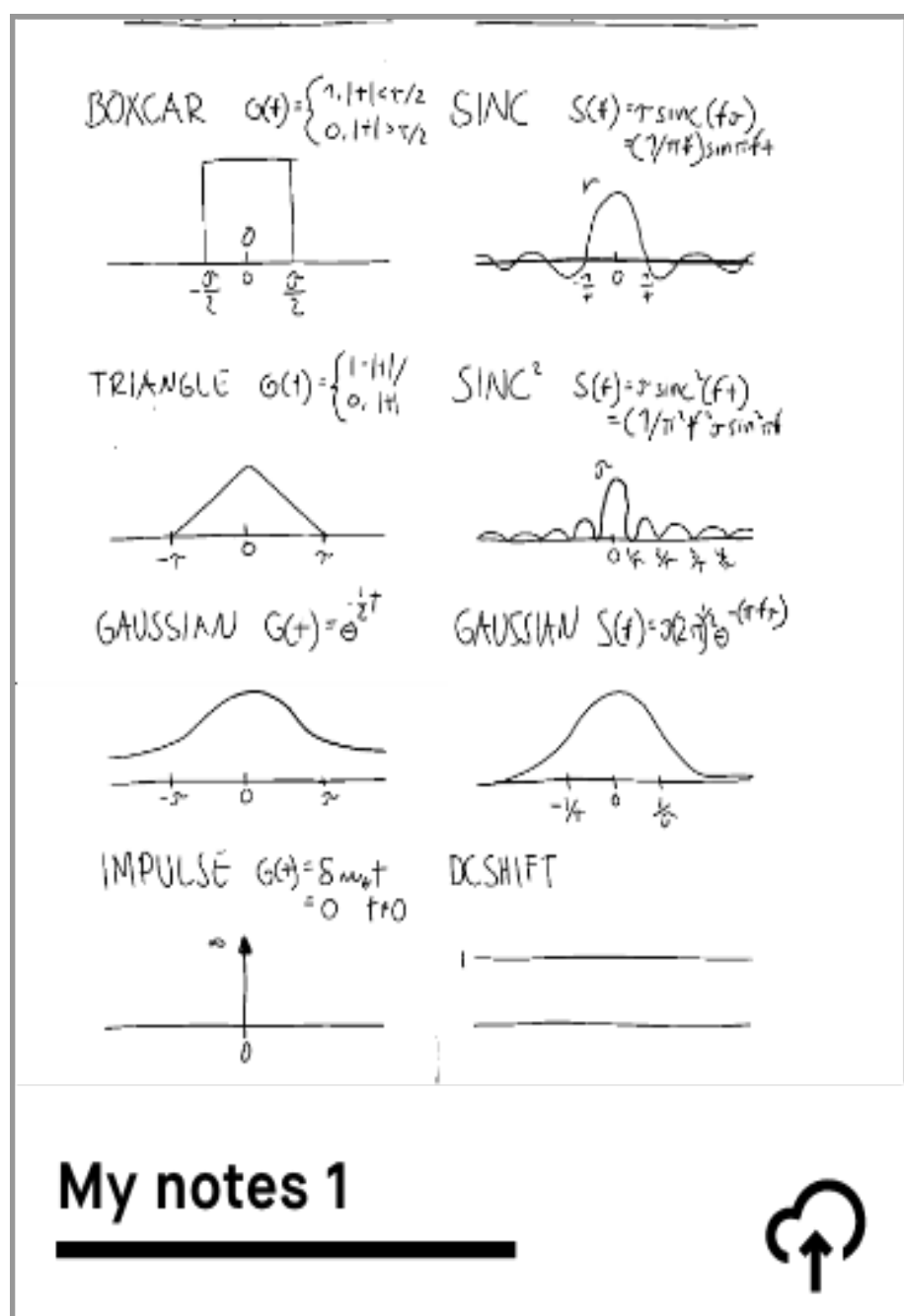

Progress bar

A progress bar will appear while syncing and exporting files. You will also see a cloud connection status icon.

In the event of a sync failure, there is an option to check sync.

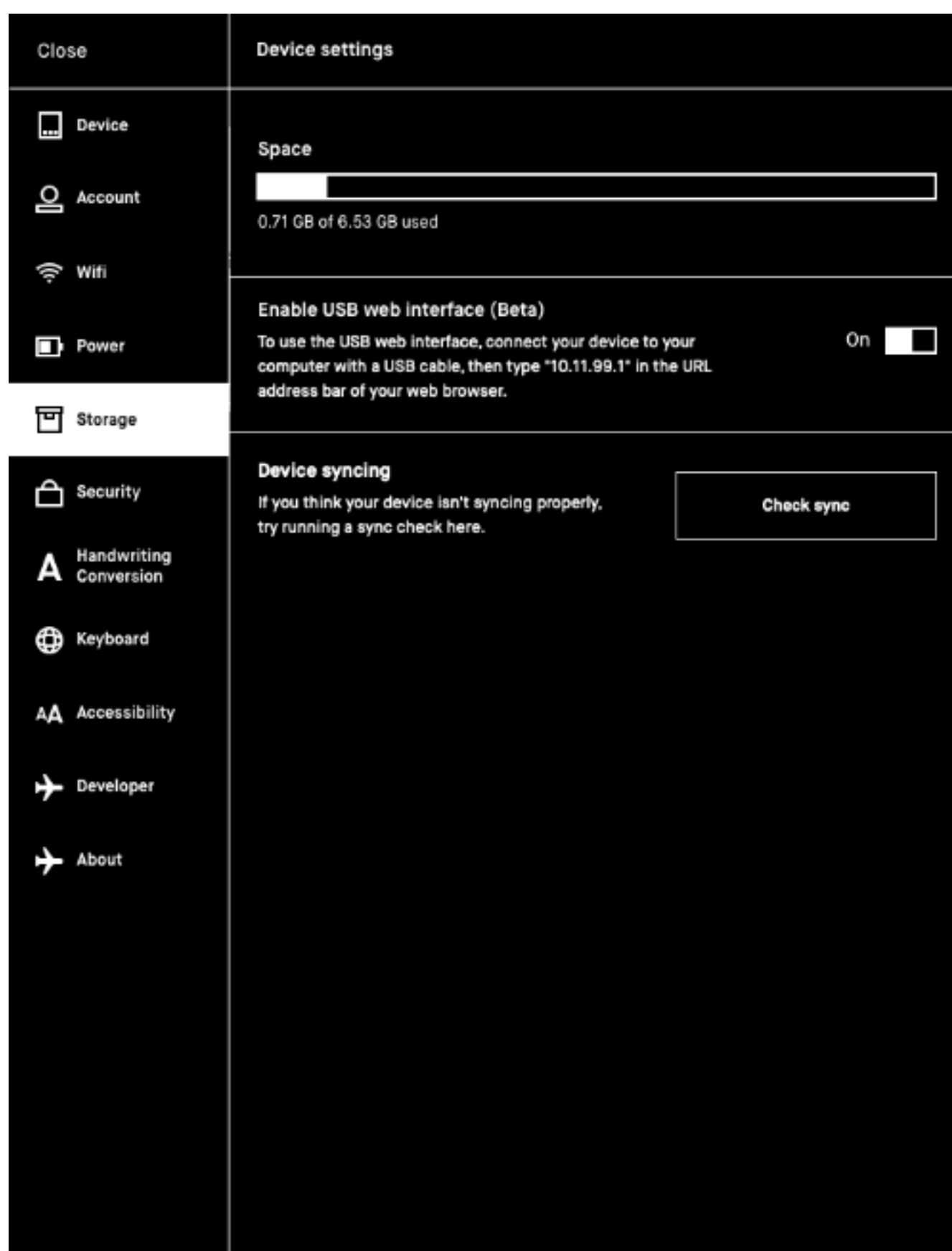

Check sync

The check sync option in the settings menu helps diagnose any sync issues. To find it, tap **Menu**, **Settings**, then **Storage**. To check if your device is syncing properly, tap **Check sync**.

2.9 Sharing via email

Sharing a file from the home screen

1. Long-press the item you want to share.
2. Tap **Send** to send.

Tap Send

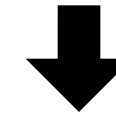

Long-press

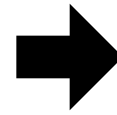

Close

Favorite Rename Move Duplicate Send Move to trash

My files

Sort by Last updated

Wan Project Meetings

Friday meeting Page 1 of 23

Planning Page 1 of 23

Overview Page 1 of 23

Brainstorming Page 1 of 23

Article Page 1 of 23

Brain notes Page 1 of 23

Calculations Page 1 of 23

Lack of Sleep Page 1 of 23

File name Page 1 of 23

File name Page 1 of 23

78% Wi-Fi

Sharing a file from the home screen

3. Add recipients by tapping **Add email address** under **Send to**. You can also add recipients from **Recently used** by tapping their email address.
4. Under **Message** you can add text to your email, and under **Filename**, edit the filename.
5. **Export** lets you choose which pages you would like to include, and **Export format** lets you choose the file format.
6. Tap **Send** in the top right corner to share.

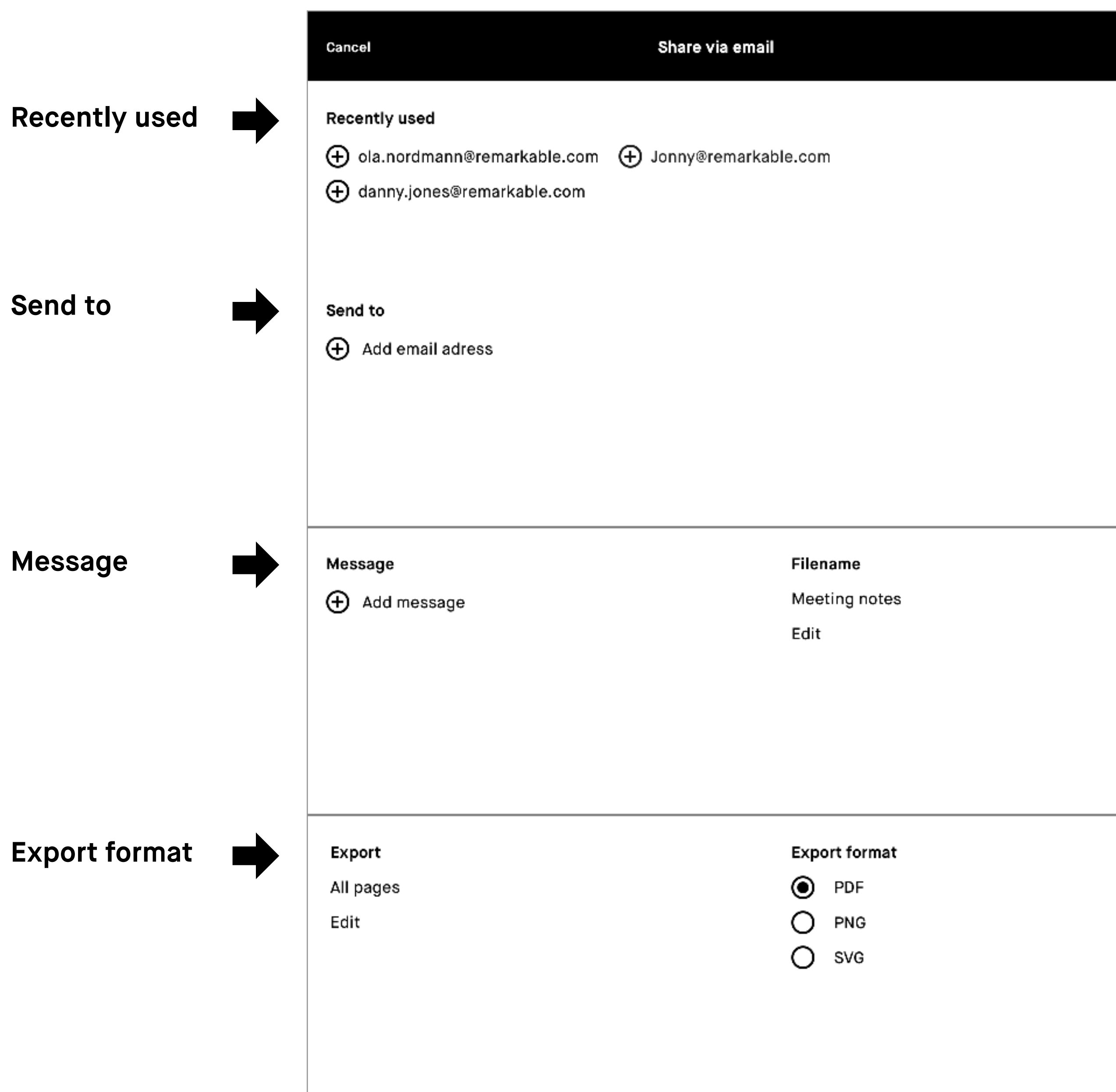

Sharing single or multiple pages from within a notebook

1. Open a file and tap the **Notebook** icon (📁).
2. Tap **Page overview** (📄).
3. **Long-press** on the page, or pages, you want to share.
4. Tap **Send** to send.

Note You must be connected to Wi-Fi to be able to share from your reMarkable.

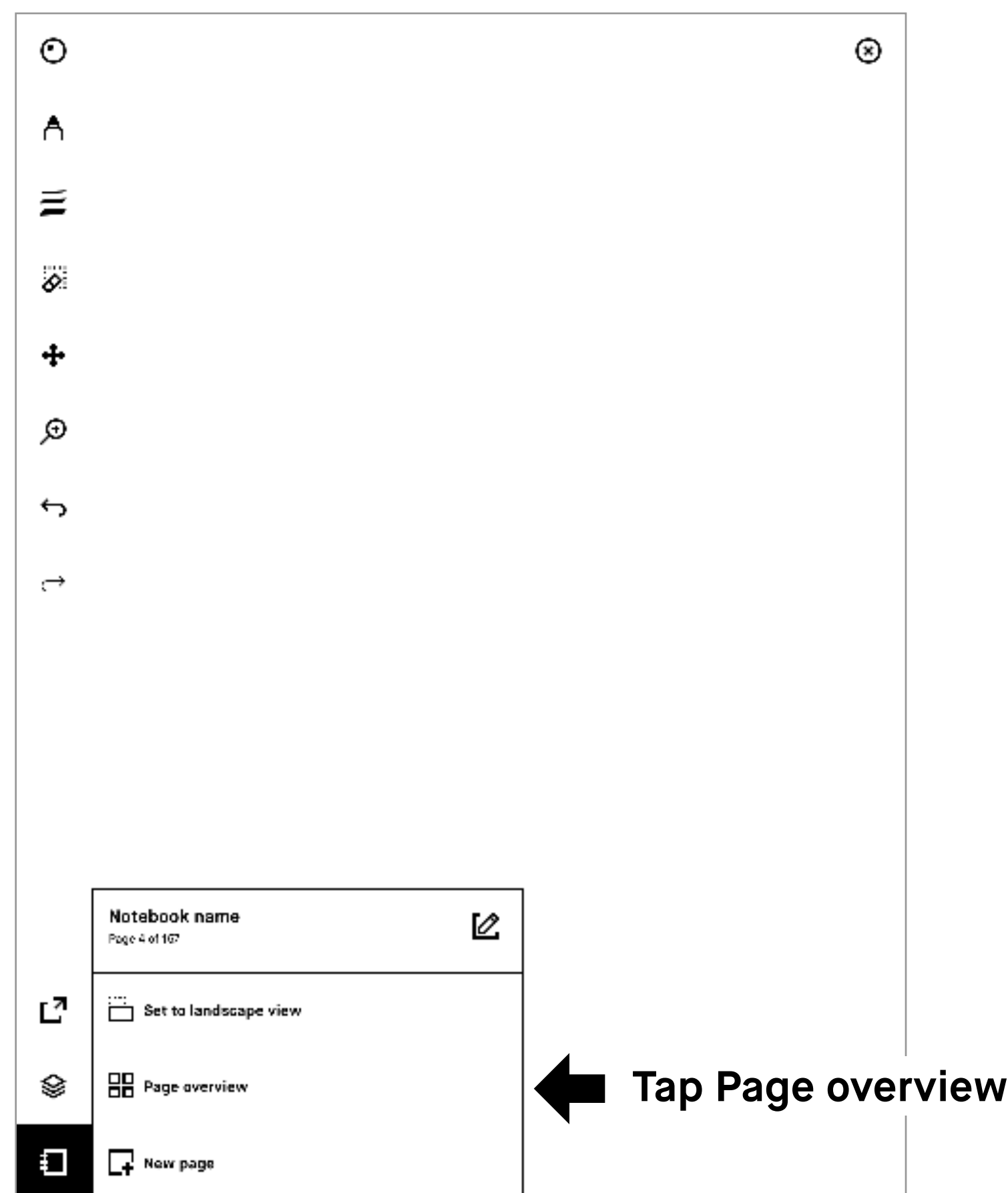

Sharing the current page from within a notebook, with the option to add additional pages

1. Tap the share icon in the sidebar menu.
2. Tap **Send by email**.
3. Add recipients, message, file name and an export format.
4. Tap **Edit**, under **Export** to add extra pages.

2.10 LiveView

Use LiveView to display what you are writing or sketching on your computer.

Note You must be connected to Wi-Fi on both devices and logged in to your desktop app to use LiveView.

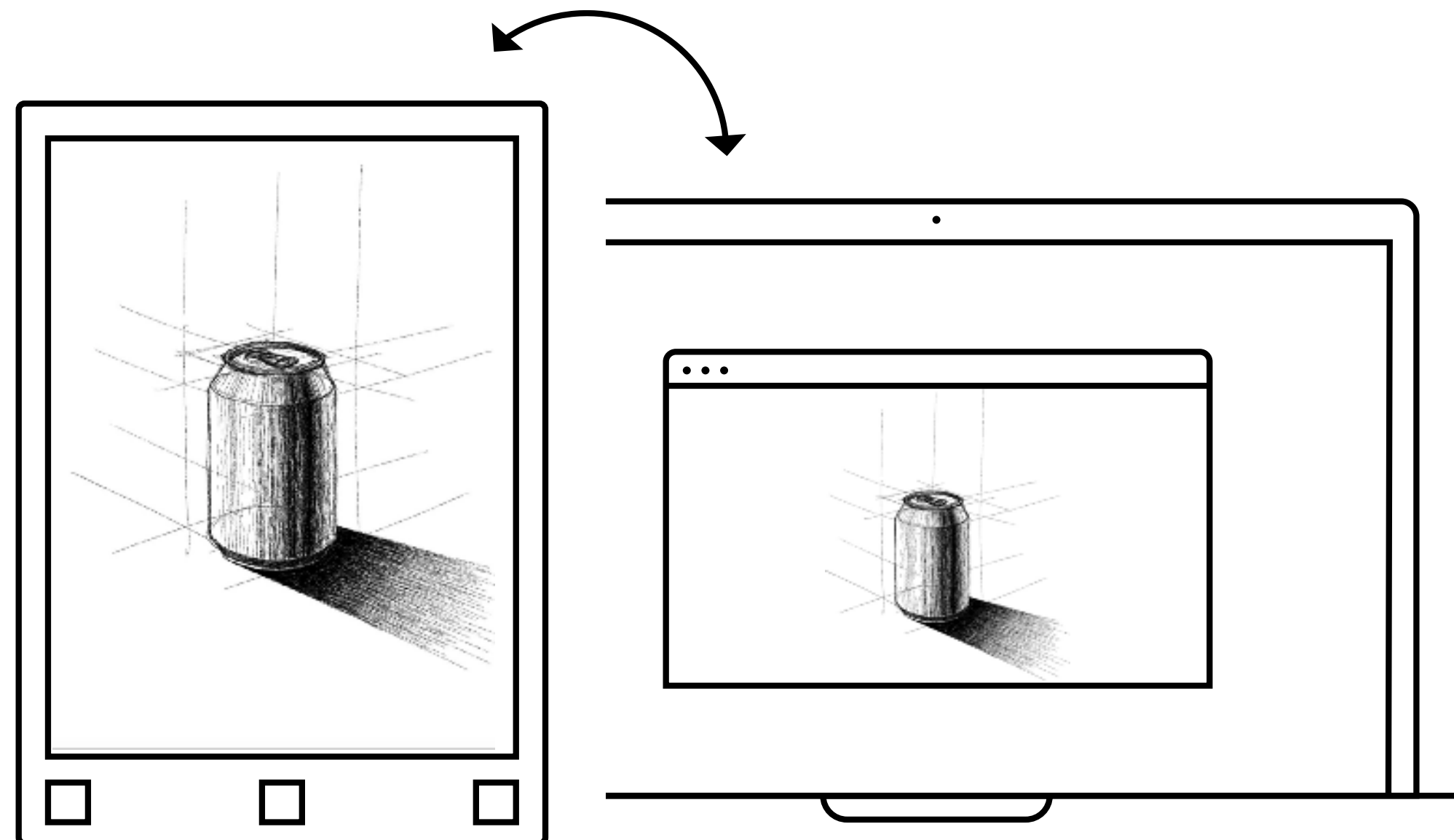

Using LiveView

1. Start LiveView by opening a notebook
2. Tap the **share** icon (🔗)
3. Select **LiveView** icon (📺)
4. Tap **Accept** LiveView from your desktop app to start the session.
5. End **LiveView** by tapping Turn LiveView off on your desktop app.

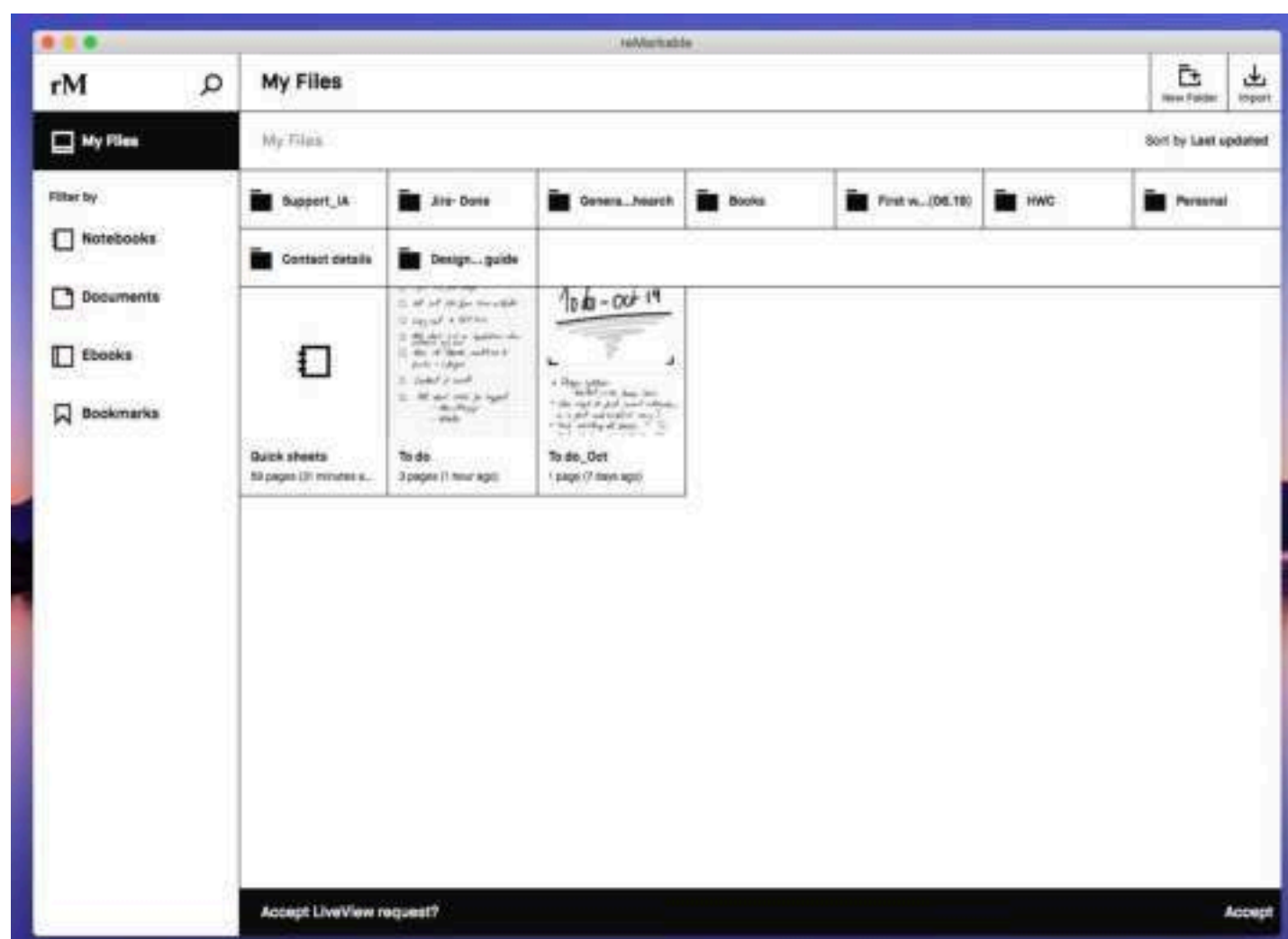

← Tap Accept on your desktop app

Page management

- 3.1 Page orientation
- 3.2 Page management
- 3.3 Adding pages
- 3.4 Moving and reordering pages
- 3.5 Duplicating pages
- 3.6 Deleting pages

3.1 Page orientation

The orientation of the toolbar can be changed by tapping the notebook (📓), PDF (📄), or ebook (📖) options icon, and making the desired choice. For landscape, tap **Set to landscape view**, or for portrait tap **Set to portrait view**.

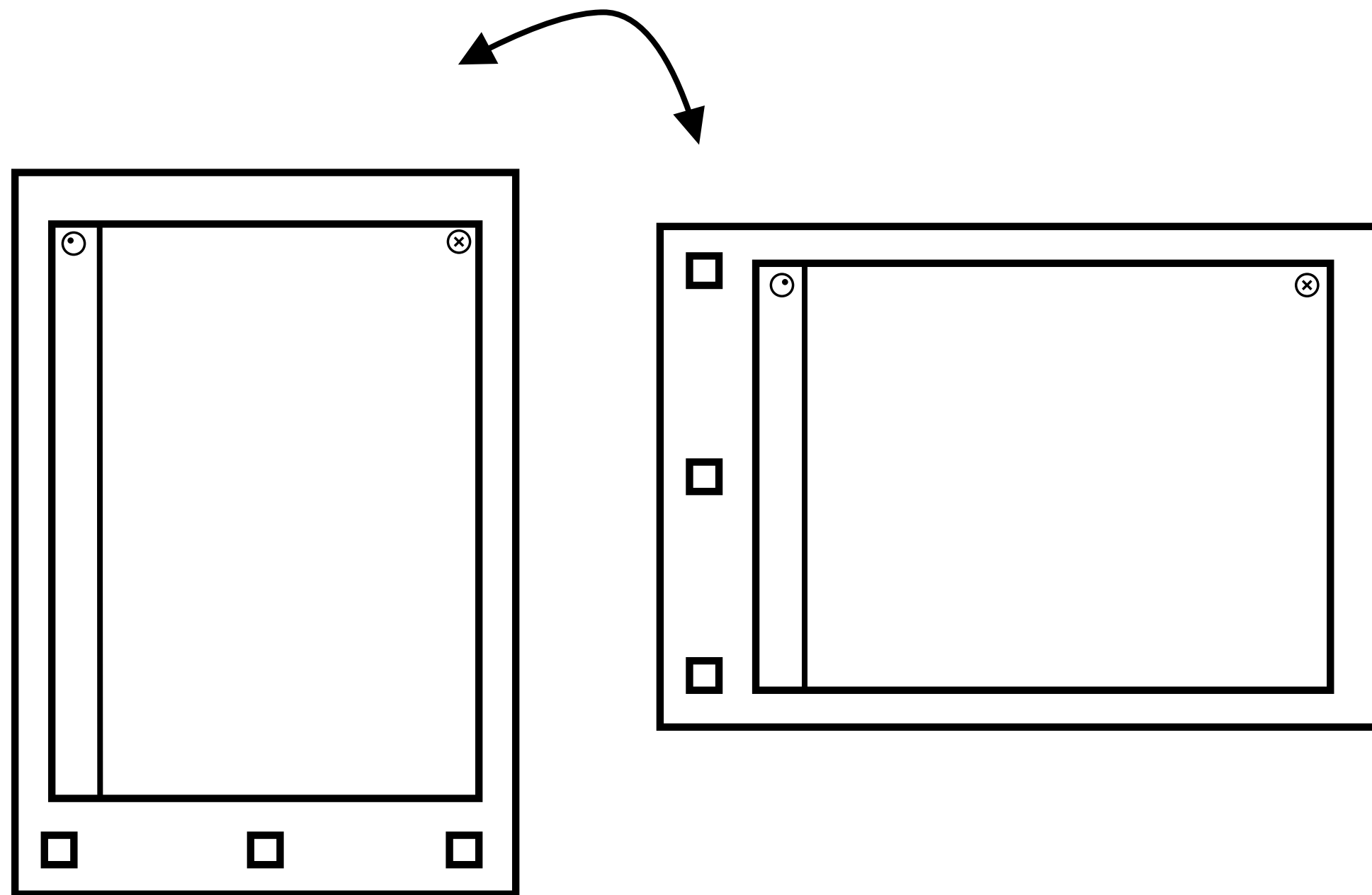

Note Notebook orientation is also defined by the selected template. For more information, see 4.4 Templates.

3.2 Page management

Page overview

Page overview is a page management function, to use it, choose the icon with the four squares (田) located under the Notebook icon (📓)

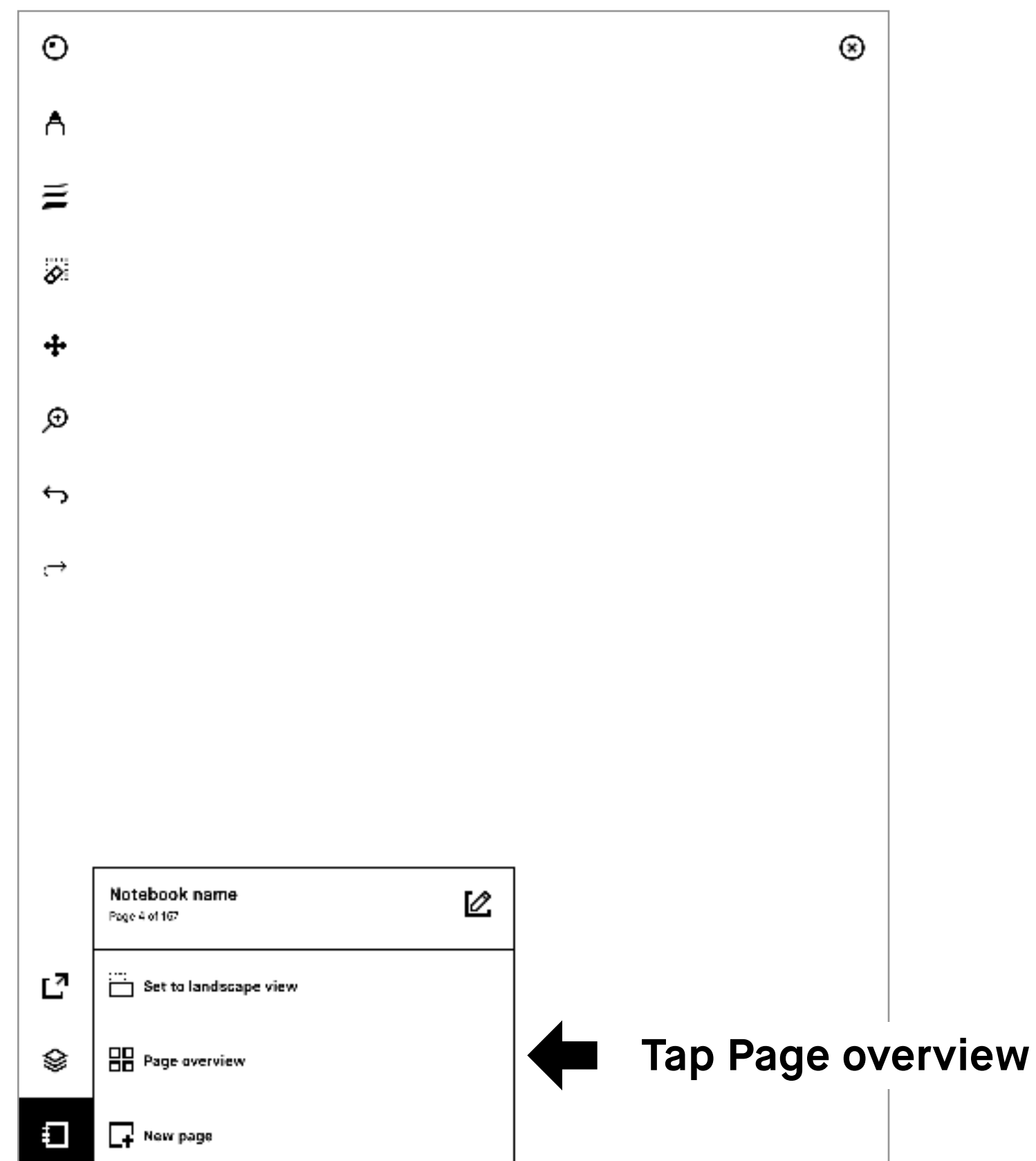

Once you're in the page overview, **long-press** to select the page you want to manage. To add additional pages just tap them. You will find the following page management options in the action bar at the top of your screen:

Add page (📄), **Move** (➡), and **Duplicate** (📄).

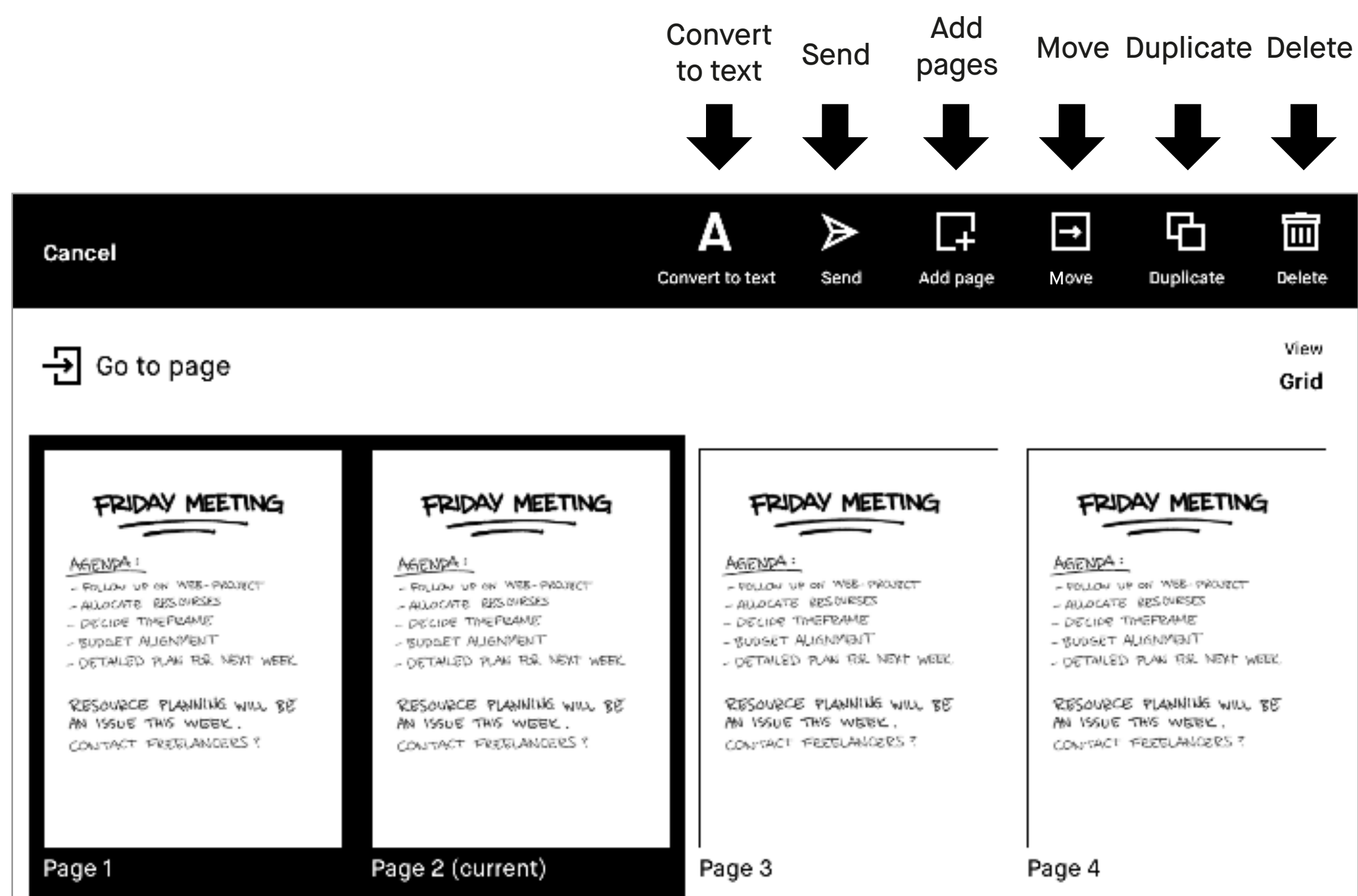

3.3 Adding pages

The simplest way to add a new page to a notebook is to **swipe to the left** when you're on the last page.

If you would like to add a page elsewhere in a notebook, you can do so by tapping the notebook icon at the bottom left and choosing **New page** (📄). This adds a new page after the active page.

In **Page overview** you can insert a page into a notebook, just **long-press** to select a page, and then tap the **Add page** icon (📄). A new page will appear after the chosen page.

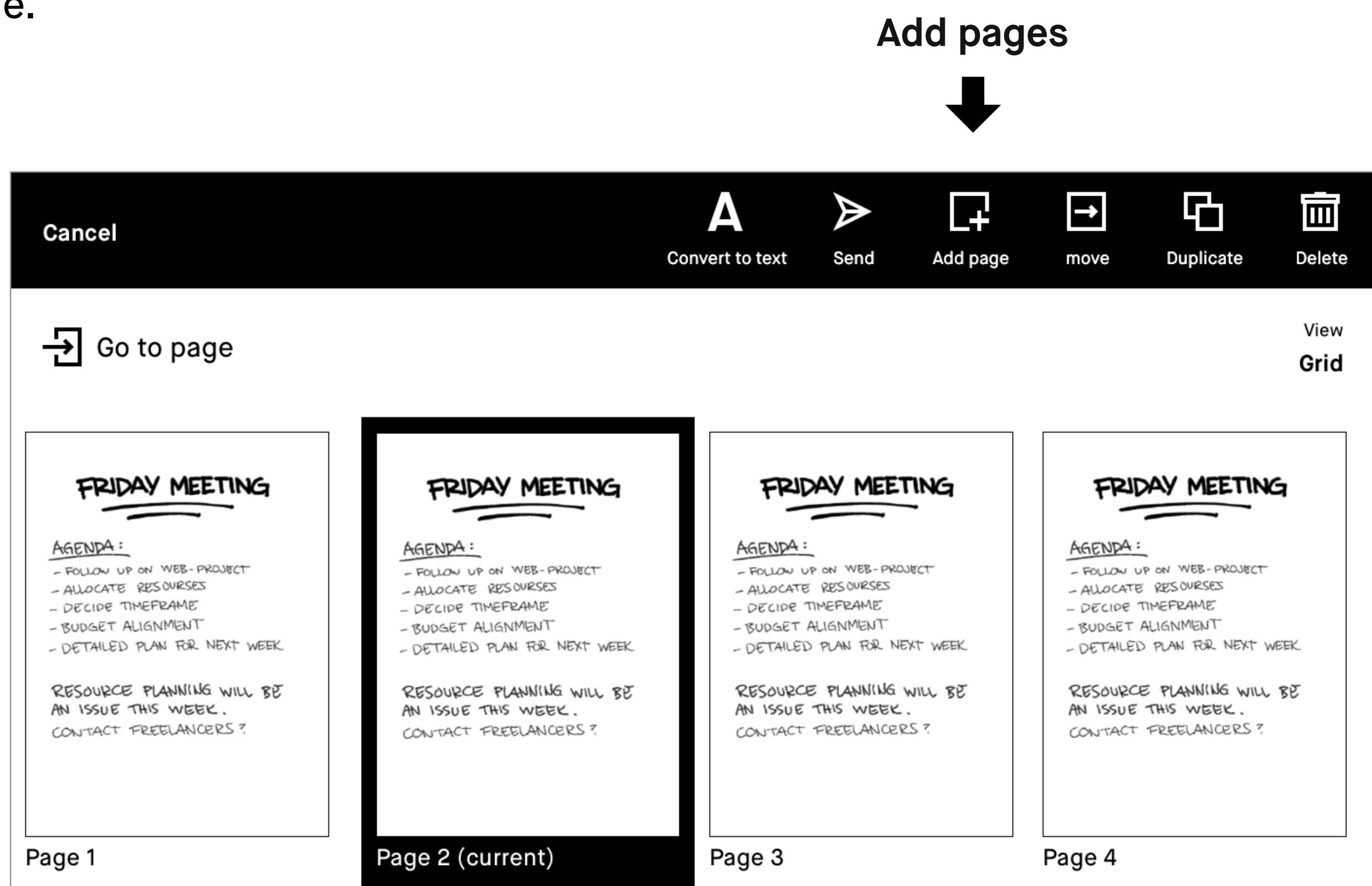

3.4 Moving and reordering pages

Tapping the **Move** icon (⇄) will allow you to either move pages within a notebook, or from one notebook to another.

To move a page within a notebook, simply choose where you would like to place the page, then tap either **Place before** or **Place after** at the top of your screen.

To move a page from one notebook to another, select the **Move out** icon (⇄) and then choose to move it to a new, or existing notebook. You can then choose where you would like to place the page. If you don't choose an exact location, the page will be placed at the end of the new notebook.

3.5 Duplicating pages

Tap the **Duplicate** icon (📄), to make a copy of the current highlighted page. An exact copy will appear after the page highlighted in the notebook. To add a copy after a different page, **long-press** to select that page, before tapping **Duplicate**.

Duplicate

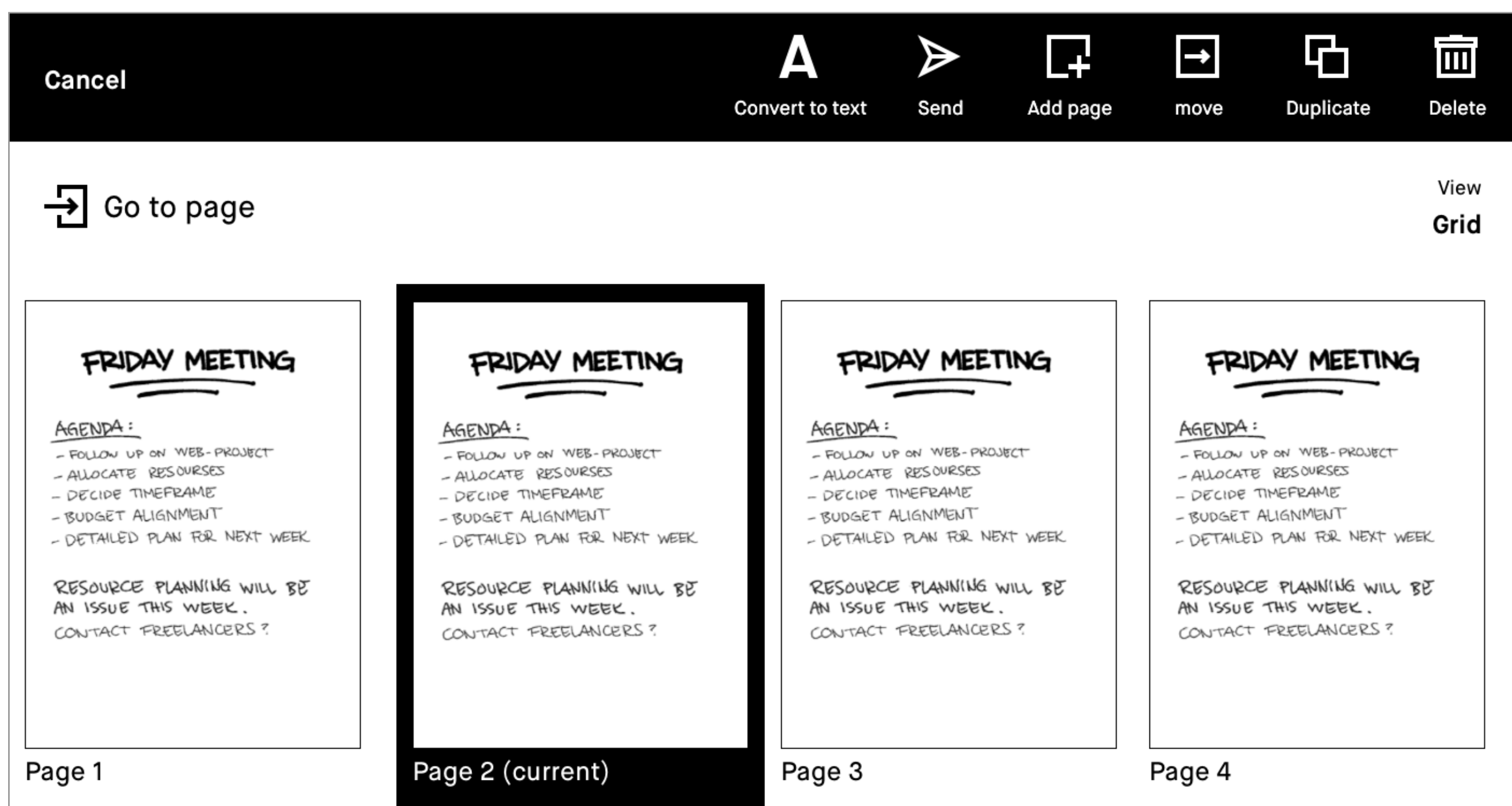
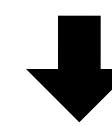

3.6 Deleting pages

1. Open quick sheets or a regular notebook, and tap the **Notebook options icon** (☰).
2. Tap the **Page overview button** (田).
3. Long-press the page(s) you want to delete.
4. Tap **Delete** in the top menu.

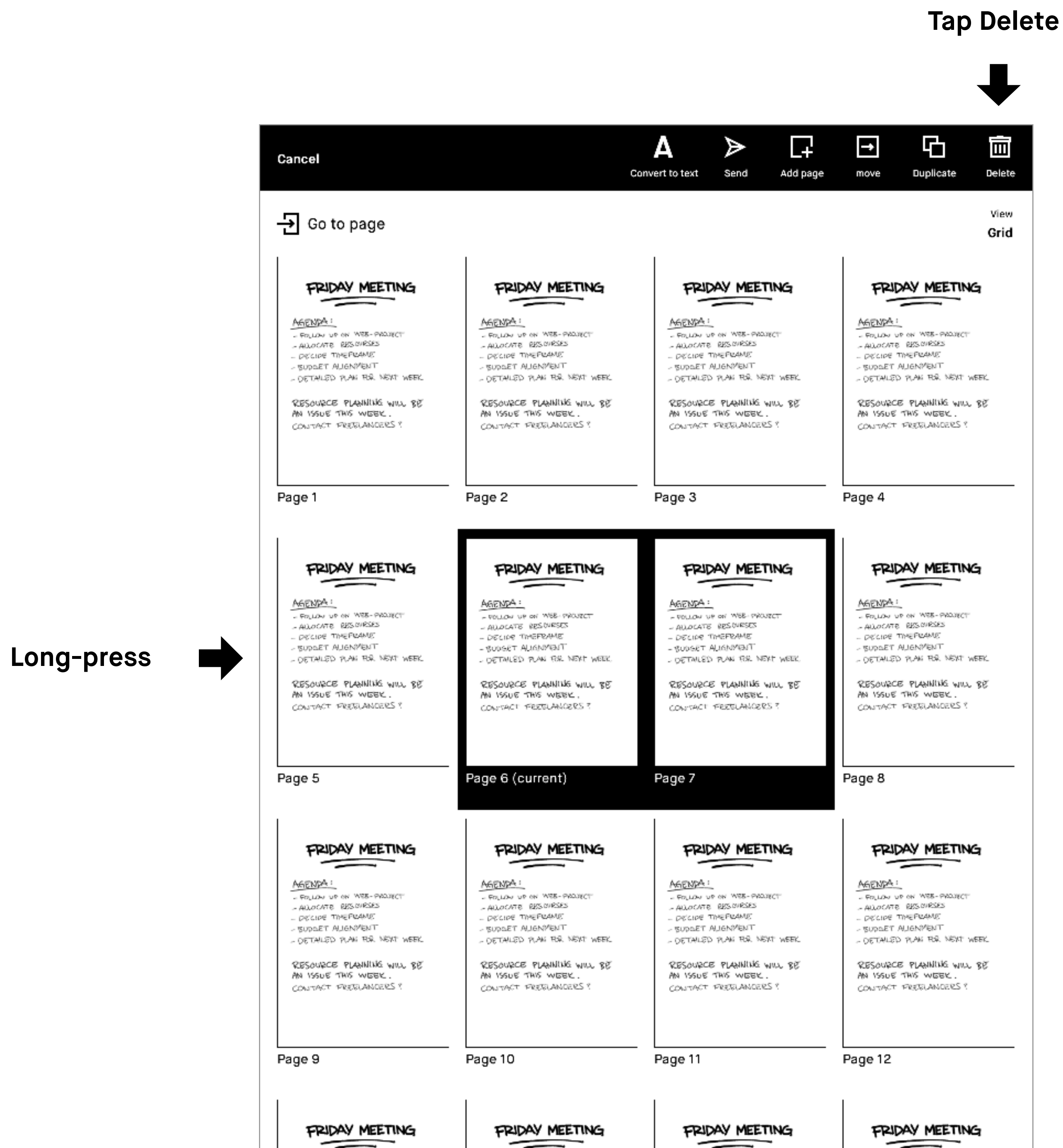

Note Pages within a document or an ebook cannot be deleted.

Notetaking and sketching

- 4.1 Finding your favorite pen
- 4.2 Erasers
- 4.3 Quick sheets
- 4.4 Adjusting the toolbar menu
- 4.5 Templates
- 4.6 Handwriting conversion
- 4.7 Layers
- 4.8 Selection tool (copy, paste, and other functions)

4.1 Pens and brushes

Pen



Ballpoint

Your typical pen style; like a ballpoint pen, it has some pressure sensitivity, but doesn't react to tilt.



Fineliner

A rounded, even style with a stroke that has no texture, regardless of tilt and speed.

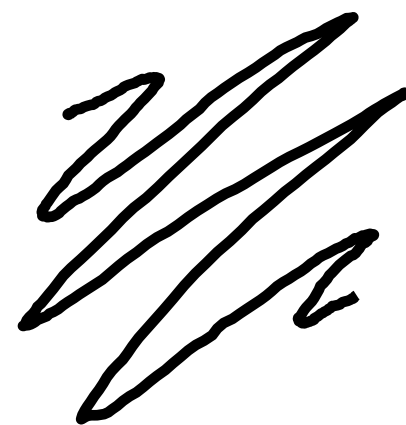

Marker

A textured style with a stroke that is affected by the speed and pressure of the stylus.



Pencil



Pencil

Has texture strokes similar to a real pencil, responds to the pressure and tilt applied.



Mechanical pencil

Has a consistent texture and line width.



Brush



The paintbrush

A textured tool, sensitive to the speed, pressure, and tilt you apply.



4.2 Eraser



Eraser is a regular eraser, available in three different sizes.



Erase selection allows you to draw around an area you want to delete, making it easier to erase larger specific areas.



Erase all erases the whole page or the current layer.

4.3 Quick sheets

The reMarkable paper tablet comes with a default notebook (quick sheets) for taking quick notes on the go, without having to create a new notebook and enter in information.

Create a new page in
Quick sheets

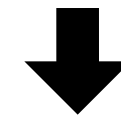

Quick sheets is
always available
under **My Files**,
and cannot be
moved or deleted.

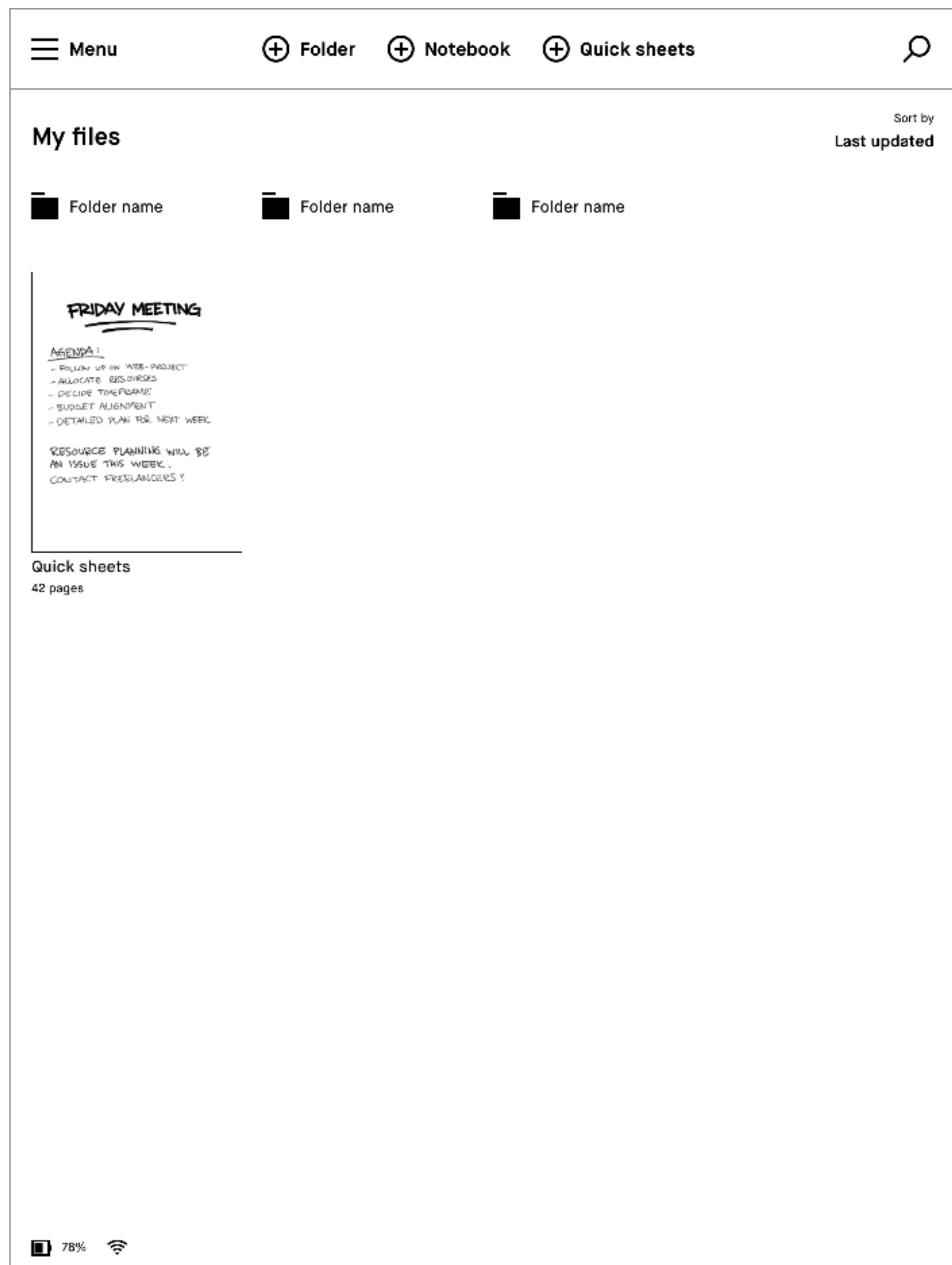
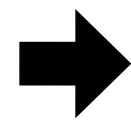

Note Remove content by deleting a page or using the **Erase all** tool.

4.4 Adjusting the toolbar menu

The toolbar menu exists in two states tailored to different scenarios.

Note Files will open in the same state you left them.

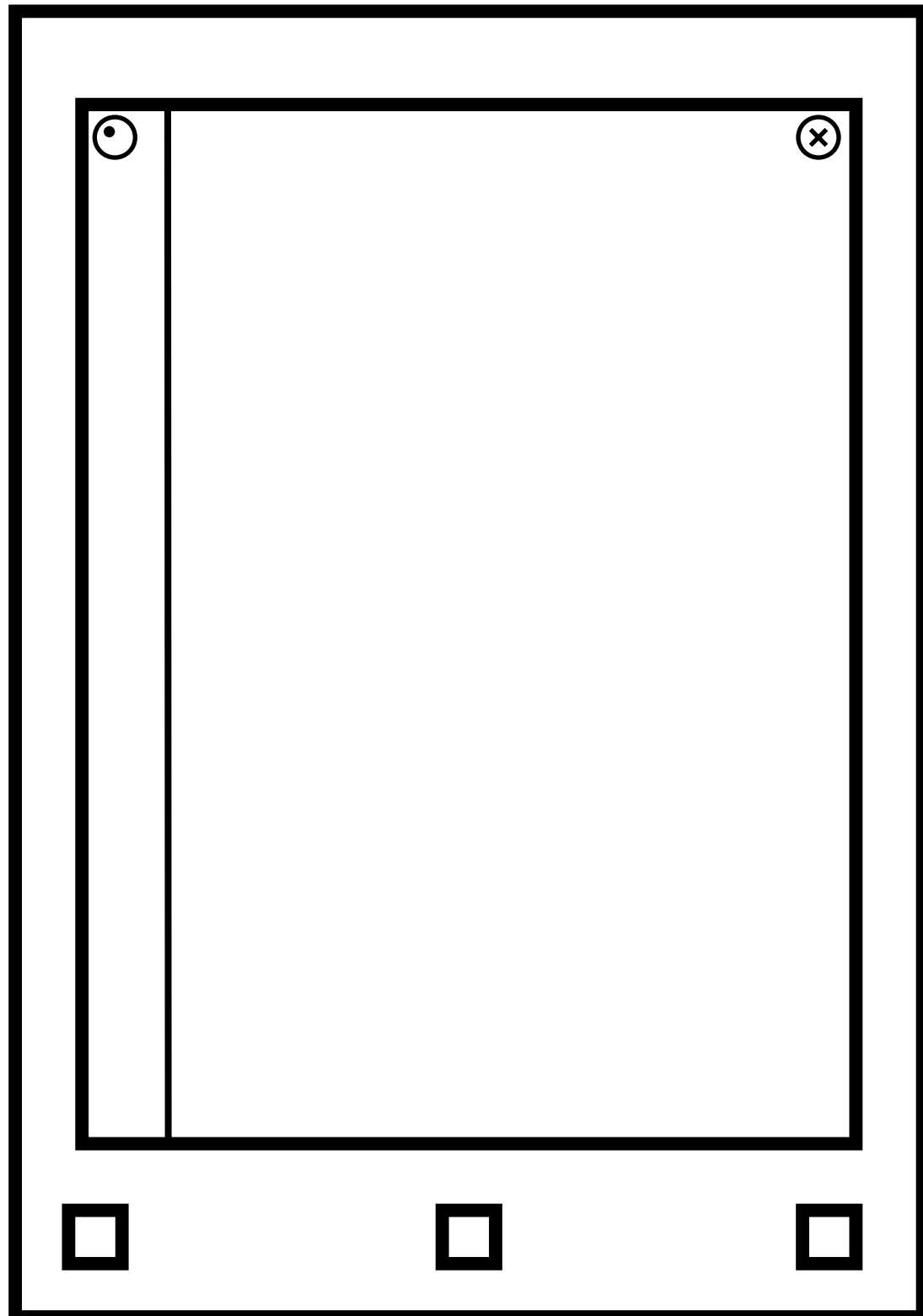

The **toolbar** is showing and presents all available tools.

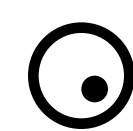
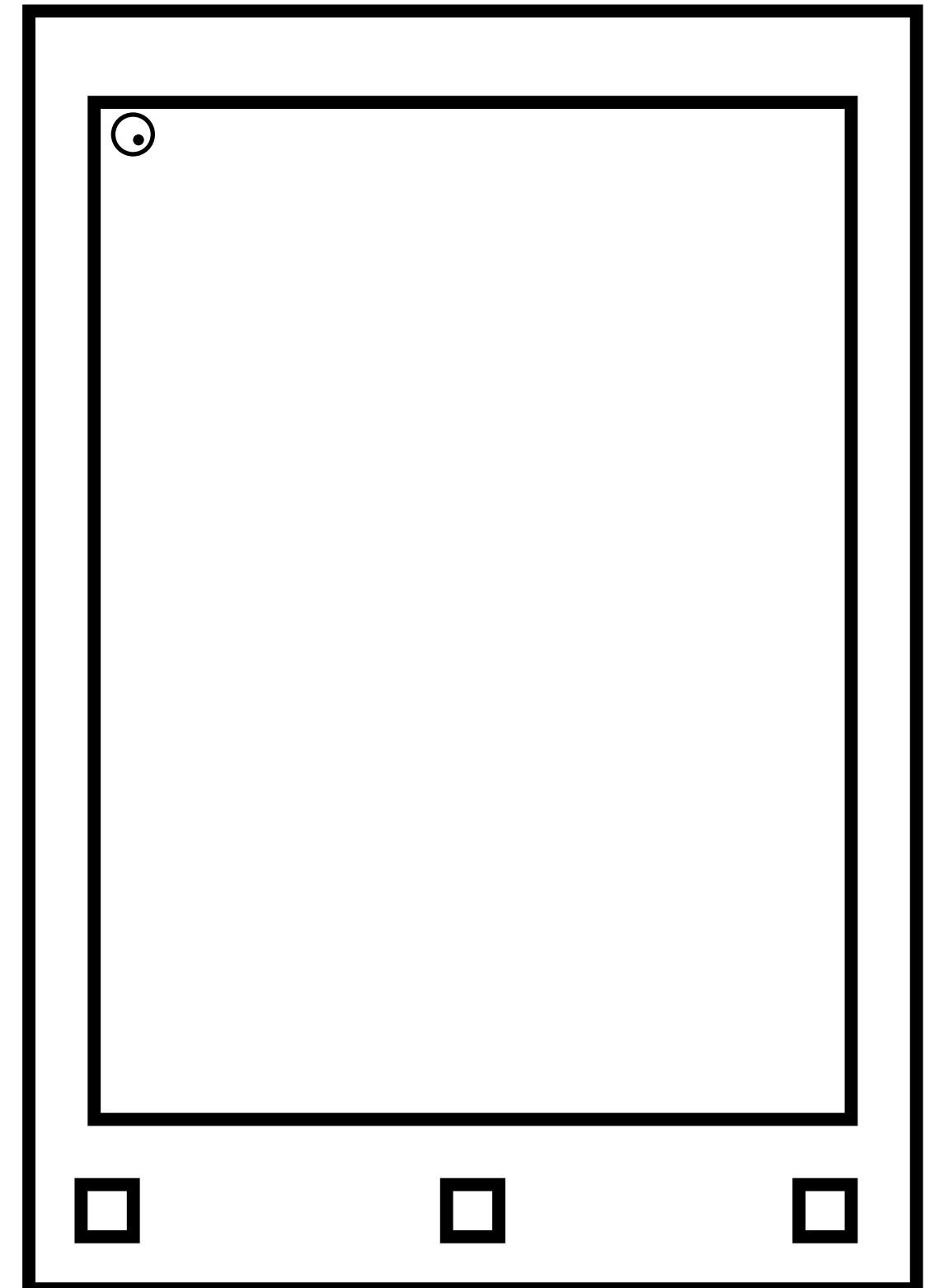

The **toolbar** can also be hidden, for more focus on your content.

4.5 Templates

Templates are preset formats to be used as an aid when writing or drawing in your notebooks. All templates are available in portrait and landscape view. The chosen template will decide the orientation of your notebook.

Select a template

1. Create or open a notebook.
2. Tap the **layers** icon (📁), found on the bottom left corner in the notebook.
3. Use your finger or the Marker to browse through the templates. Tap on a template to select a template for your notebook.
4. Tap **Save** to set the template to your page.

Examples of different templates

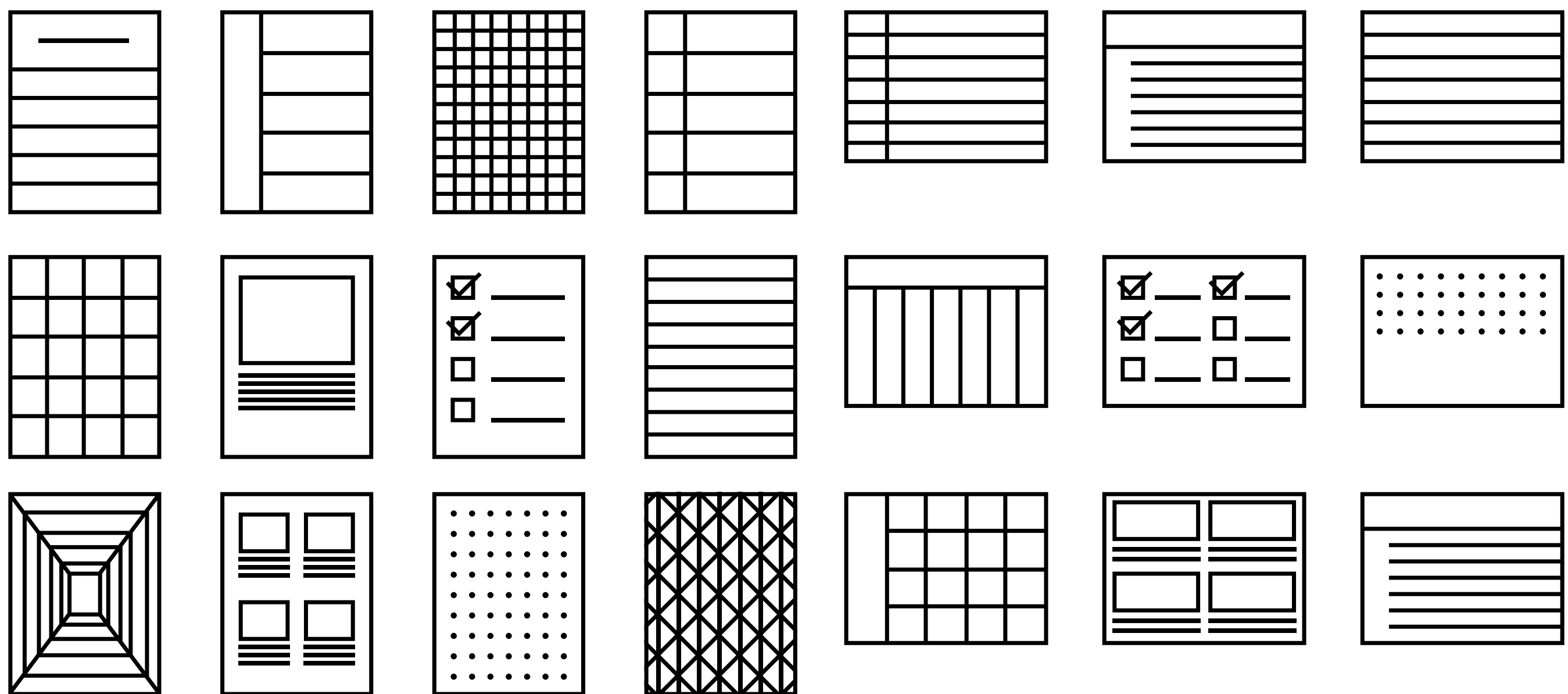

You can set different templates to different pages in a notebook, just tap the layers icon, then tap the template layer and choose a new template.

The template on the last page of a notebook will be the default for all new pages within that notebook. To remove a template, simply tap the layers icon, then tap the template layer and choose the blank template.

The template overview shows your last used templates for quicker implementation, or you can tap **View all templates** to see all the templates in a categorized overview.

4.6 Handwriting conversion

There are four important things you need to know about handwriting conversion:

1. reMarkable only converts handwritten notes in notebooks at the moment, not in PDFs or ebooks.
2. You need to be connected to a Wi-Fi network and logged in to a reMarkable account.

Note If you don't already have one, you can create a reMarkable account at my.remarkable.com.

3. You can edit and share your converted notes via email (see below) but they will not be stored on the device.
4. Writing at an angle or non-horizontally doesn't work; neither do symbols (such as mathematical symbols or diagrams), but several forms of bullet points are recognized...and some smiley faces too.

Convert in your language



For the best results, go to settings, Handwriting Conversion, and specify which language your notes are written in. We currently support 33 languages.

1. Go to the **Settings** page.
2. Select **Handwriting Conversion**.
3. Tap on the language currently selected.
4. Select your new language.

How to convert your notes into typed text

1. Tap the share icon (🔗) in the bottom left hand corner.
2. Tap **Convert to text and send (A)**.

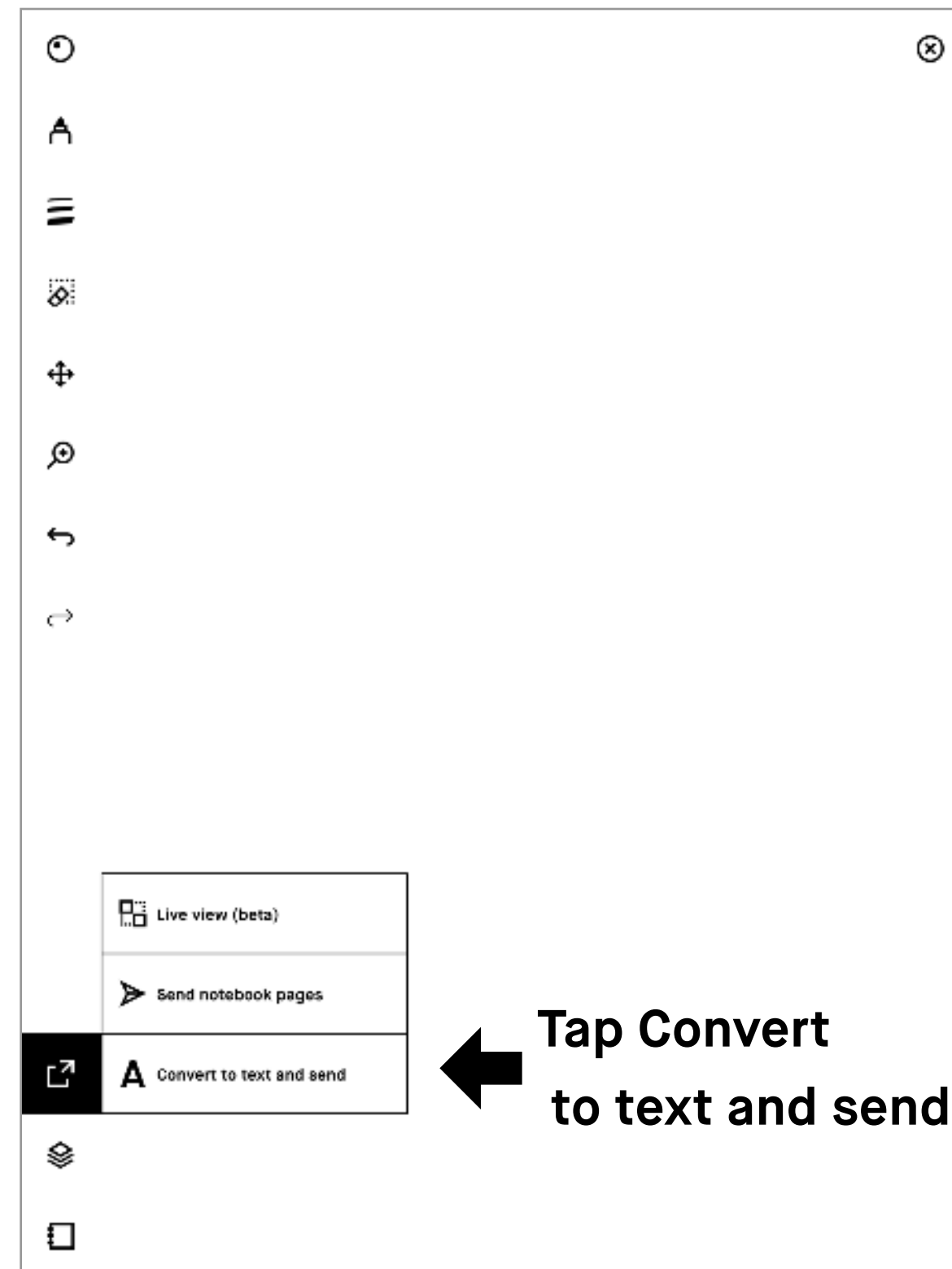

Convert multiple pages at once

1. Go to **Page overview** (🗒) and long-press on the notes you want to convert.
2. Tap the handwriting conversion icon (A).

Handwriting conversion

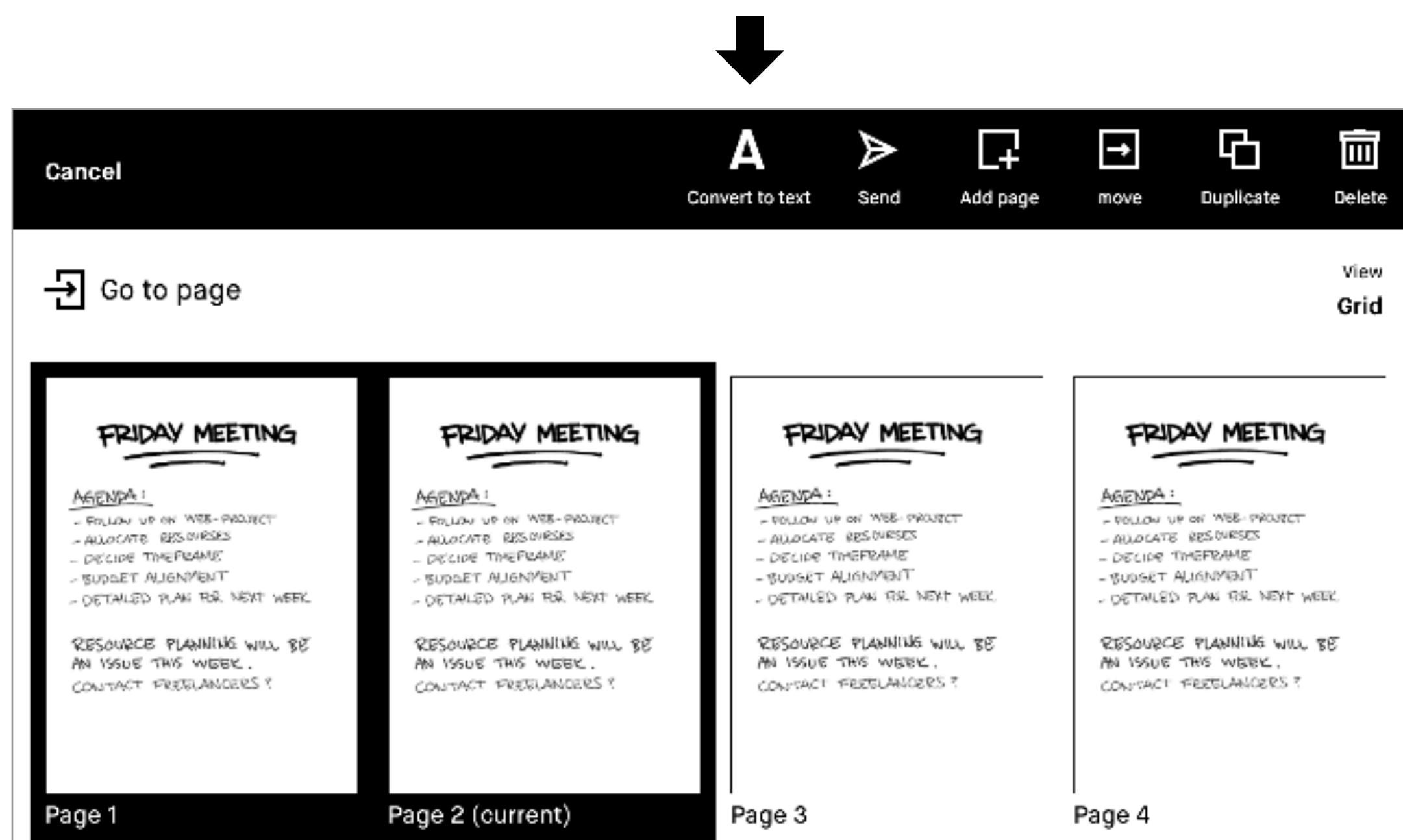

How to edit your notes before sharing them

Once your handwritten notes have been converted into text you can edit and share them with others. If you edit this text, your handwritten notes will not be affected.

To edit the text, simply tap the word or letter you want to edit and use the keyboard to make changes.

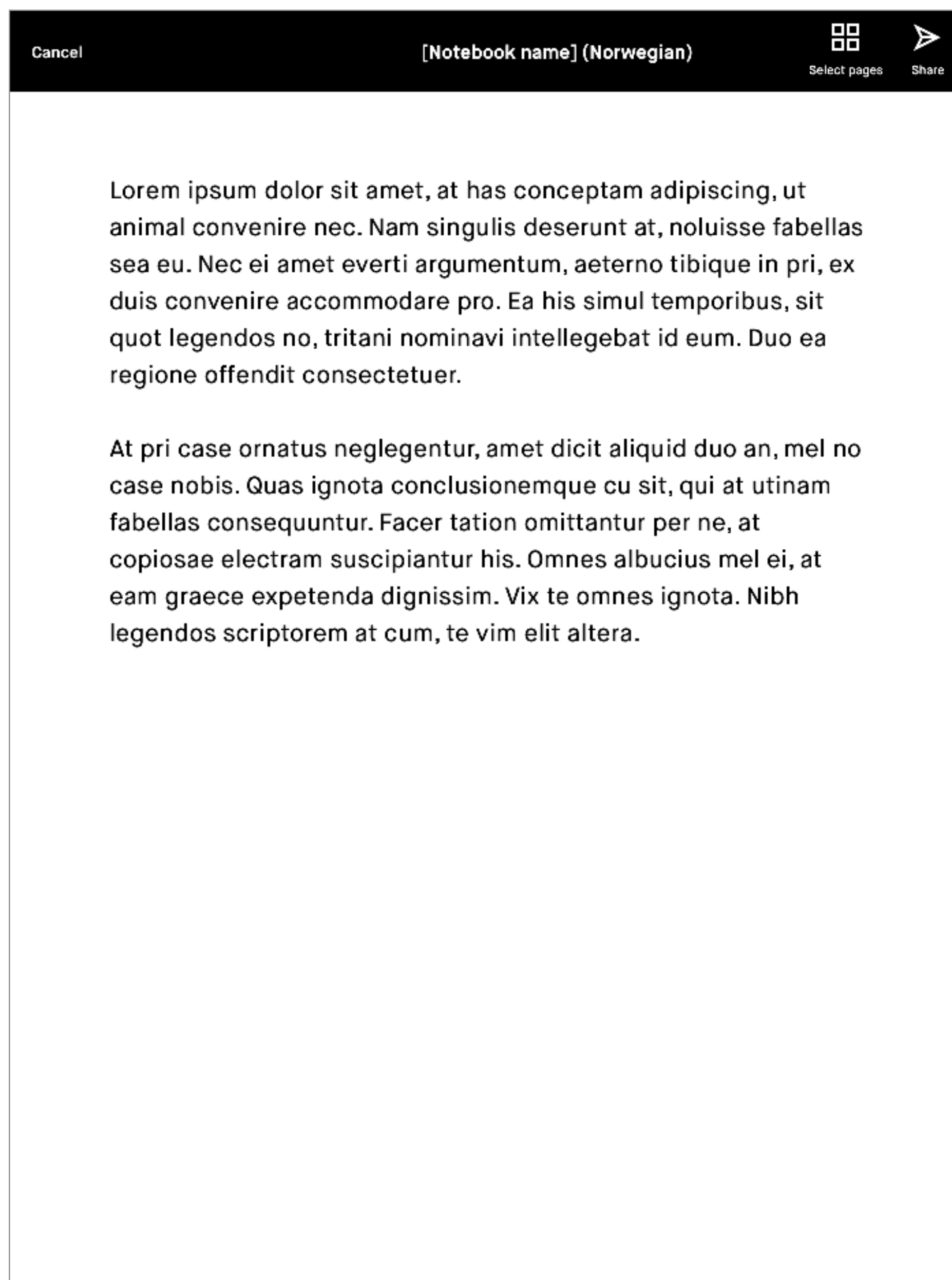

How to share your converted notes

In the action bar at the top of the screen, you will see the **Send** button. This will take you to the email sharing feature where you can input the recipient(s).

The converted document will be sent as the body text in the email.

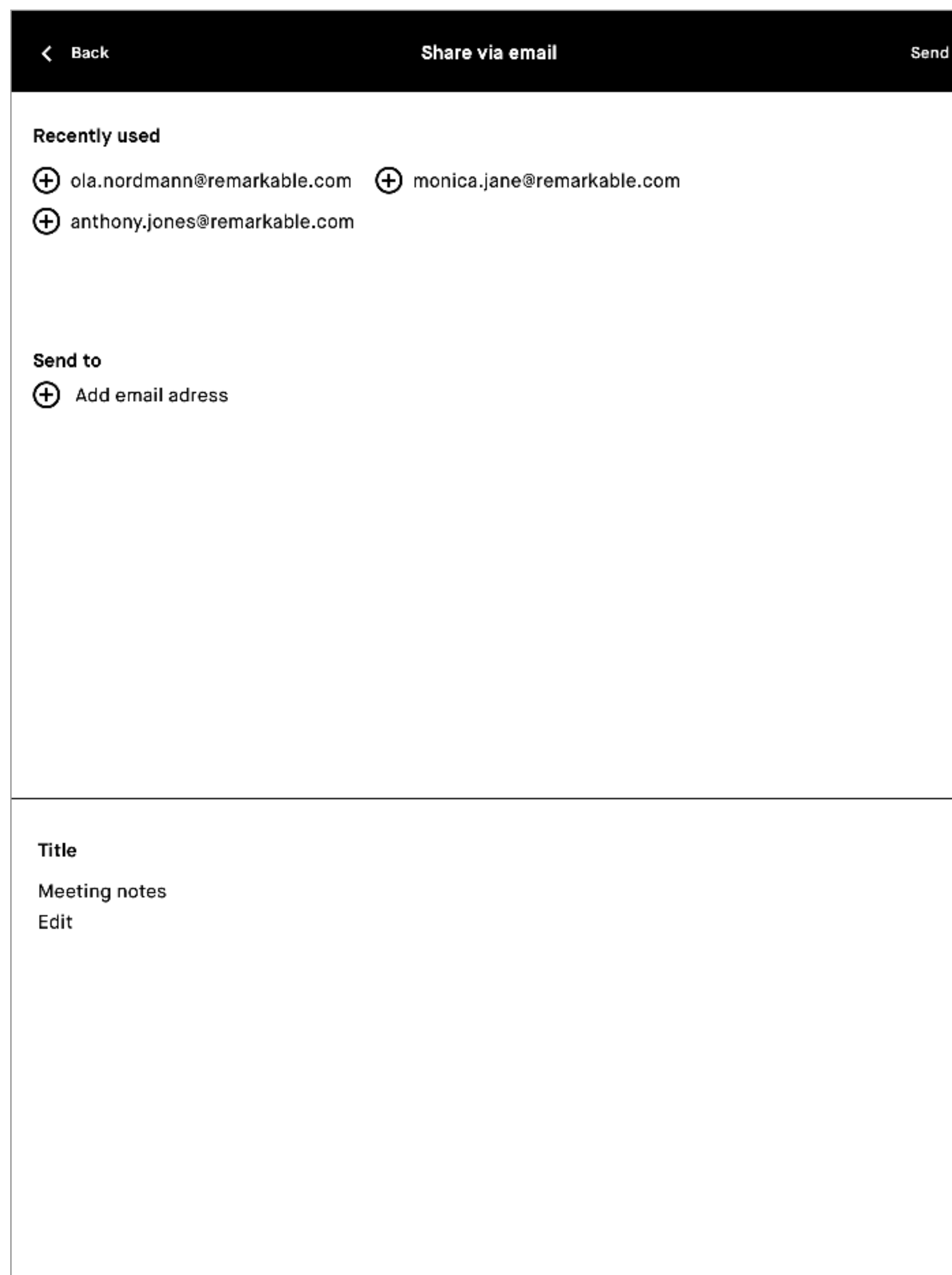

4.7 Layers

Layers allow you draw on transparent sheets that are stacked on top of each other. The sheets, or layers, may be rearranged, hidden, or deleted. You can rename (**long-press** on name), edit, and reorder your layers.

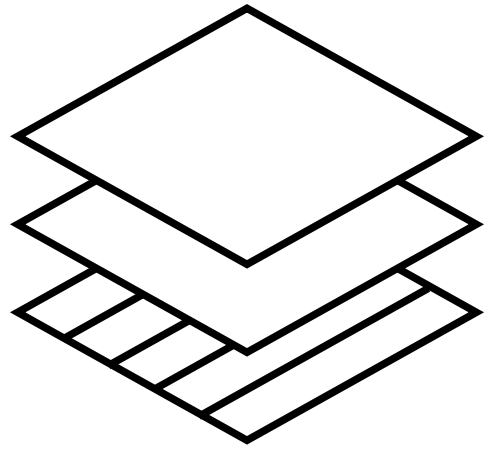

Tap layers

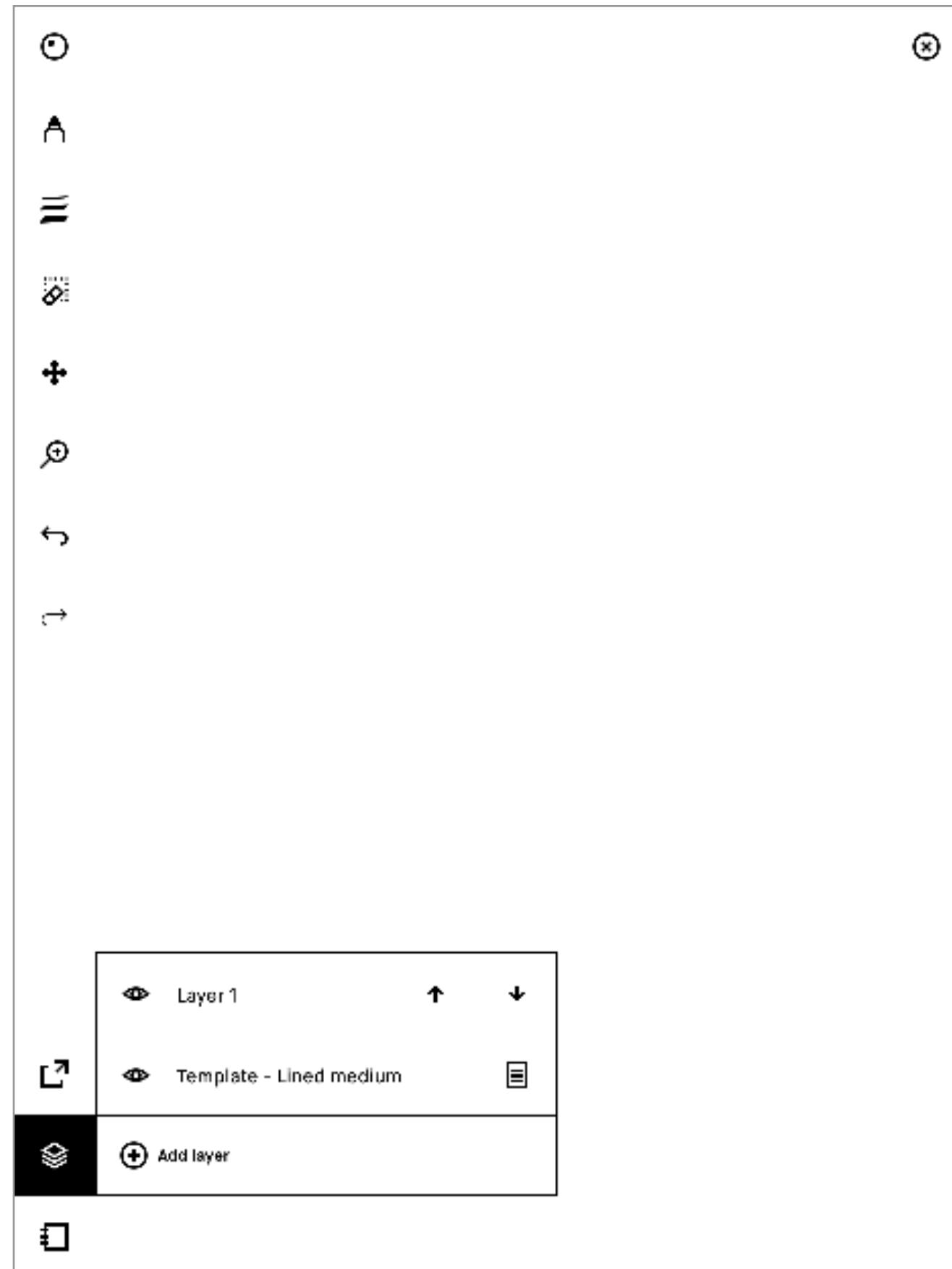
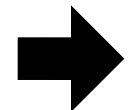

4.8 Selection tool (copy, paste, and other functions)

How to use the Selection tool

The **selection tool** (☒) allows you to move, scale, rotate, cut, copy, and paste your text or drawings. To select an object, draw a line around it with the **selection tool**.

- **Move** an object by dragging it with the Marker to the desired position. Make sure you start with the Marker inside the boundary box.
- **Scale** an object by dragging one of the corners to adjust the size. Mirror a selection by dragging one of the corners past its opposite side.
- **Rotate** an object by dragging the circle on top of the boundary box in the direction you would like it to rotate.
- **Copy or cut** a selection by tapping the copy (☒), or cut (✂) icons beneath the boundary box. Once an object has been cut or copied, you can paste it by tapping the Marker where you would like the object to appear, which you can do on any page or layer, in any notebook.

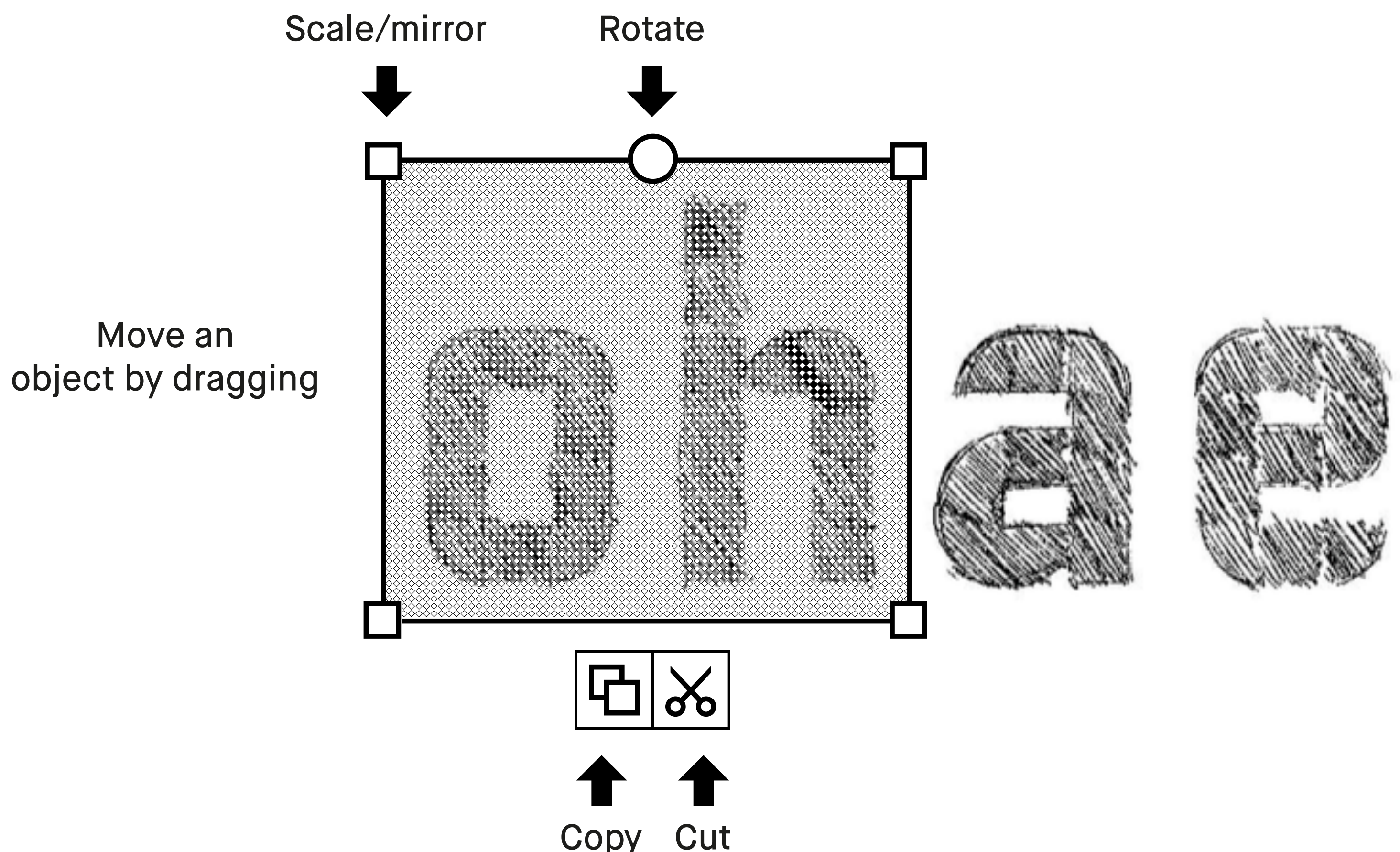

Note: a notification at the bottom of the screen always appears if there is something on the clipboard.

Reading

- 5.1 Text settings for ebooks
- 5.2 Highlighter tool
- 5.3 Cropping documents

5.1 Text settings for ebooks

Tailor the ebook view to your preferred text size, font, justification, margin size, and line spacing.

Note Text settings are only available for ebooks, not for documents (PDFs) or notebooks.

How to change text settings

1. Open an **ebook**.
2. Tap the **ebook** icon (📖), bottom left corner.
3. Tap **Text settings** (AA).
4. Adjust settings to whatever you prefer and tap **Done**.

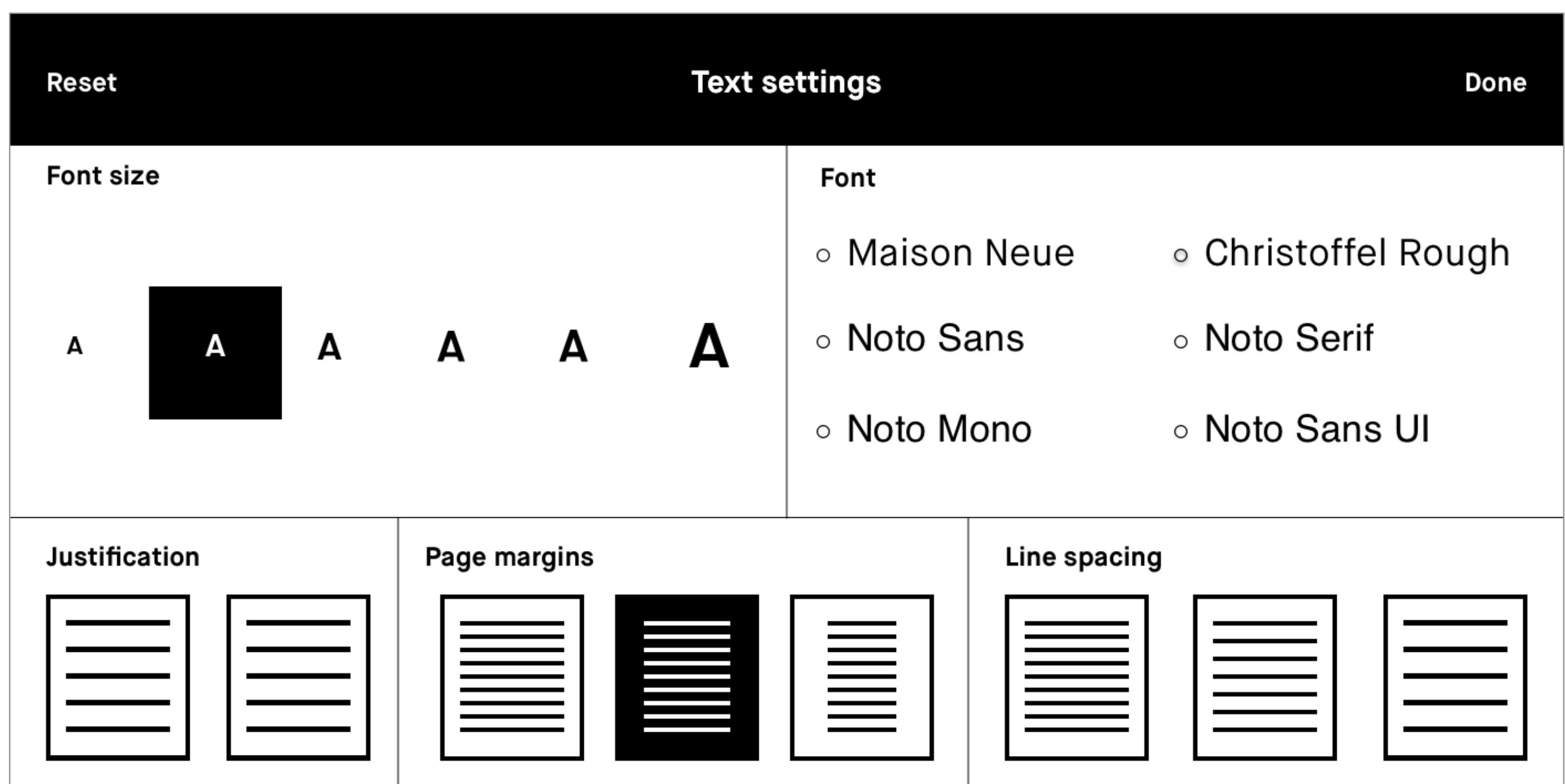

Reset your text settings

To switch back to the original text settings of your ebook, use the **Reset** button.

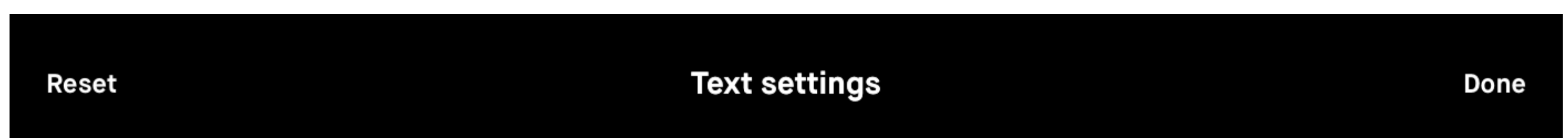
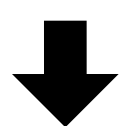

Note If you decide to change your settings after having made annotations, they may become misaligned. This could be irreversible.

5.2 Highlighter tool

Use the **highlighter** tool to highlight text in a document or ebook. The highlighter is displayed as yellow when exported to PDF or PNG.

"No more printing. No more heavy books or documents. Annotate directly in your documents. Make notes or highlight and instantly share your work. Handwriting. reMarkable offers the first paper like digital writing experience. You can even rest your hand on the display. reMarkable is a note-taking system. It lets you organize your notes in multiple notebooks."

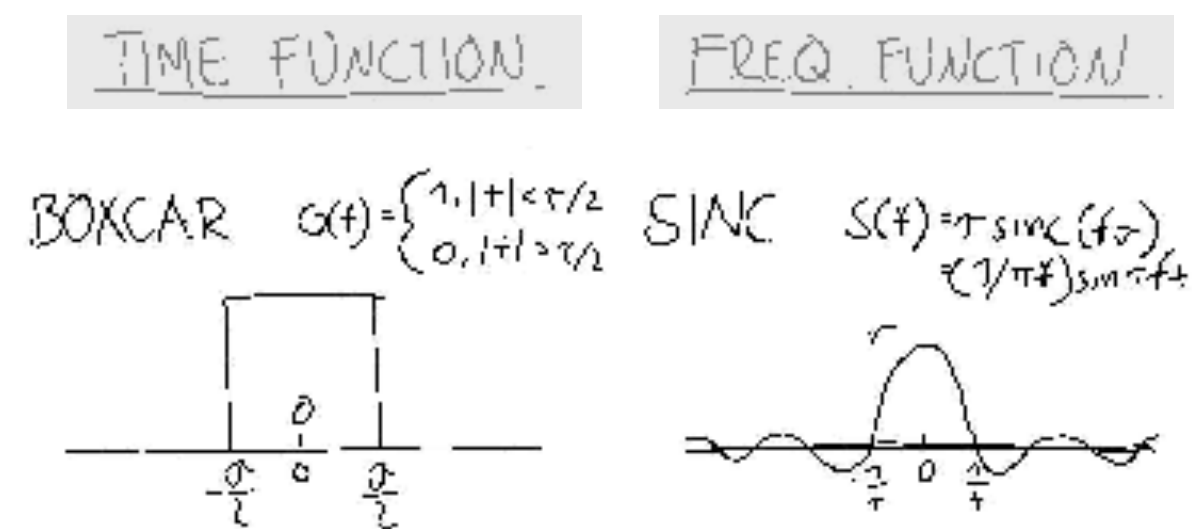

5.3 Cropping documents

Crop documents (PDFs) to hide margins for an improved reading experience. All pages in the document will be cropped when using the tool.

How to crop a document

1. Open a document (this only works on PDFs).
2. Tap the **Document** icon (☐), in the bottom left-hand corner.
3. Tap the **Adjust view** icon (⌵).

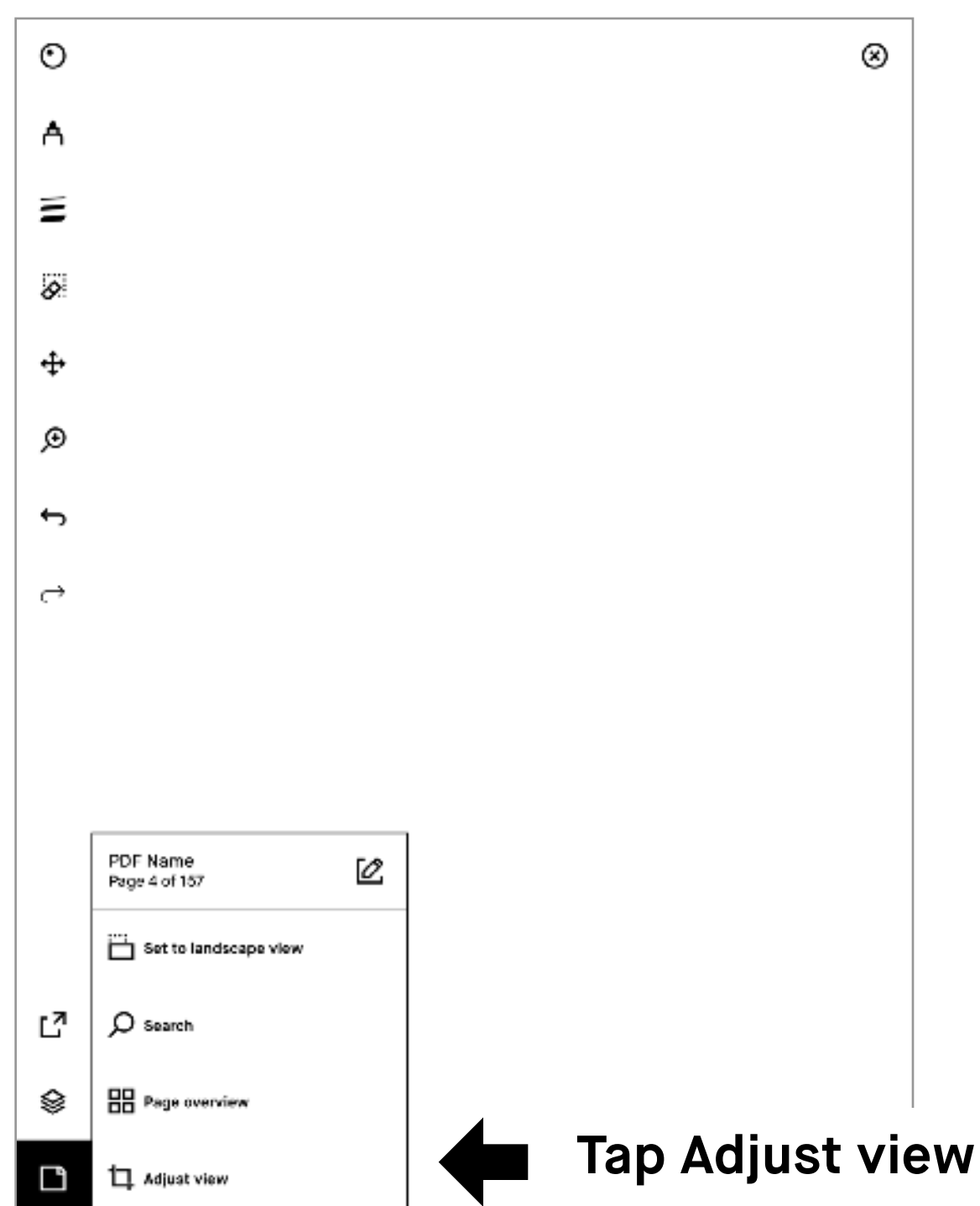

4. Use the **Marker** to define the aspect ratio you want to use, and tap **Adjust view** in the top right-hand corner.

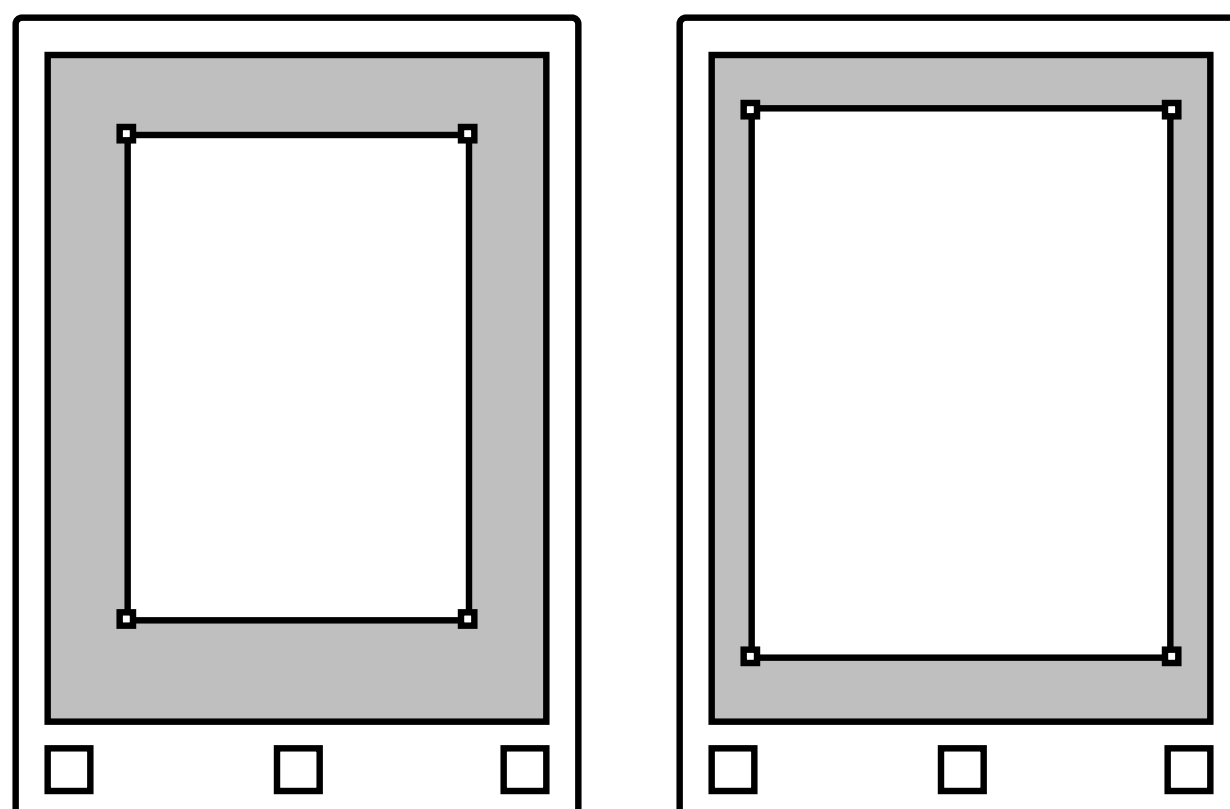

Note No edits will be made to your file, and you can adjust and remove the crop whenever you want.

Read more at:
support.remarkable.com

reMarkable

↔ 6.3 Moving, scaling, rotating, copying, and cutting

How to use the move tool

Once you've selected the **move tool**, you can use the Marker to draw around an area, making sure all strokes of the object are inside.

- **Move** an object by tapping inside the boundary box and dragging the object to the desired position.
- **Scale** an object by dragging one of the corners to adjust the size.
- **Rotate** an object by dragging the circle on top of the boundary box in the direction you would like it to rotate.
- **Copy** by tapping the **copy icon** (📄) on the boundary box to create a copy of the object. You can **tap** any pages with your Marker to paste.
- **Cut** by tapping the **cut icon** (✂️) on the boundary box to cut the object. You can **tap** any pages with your Marker to paste.

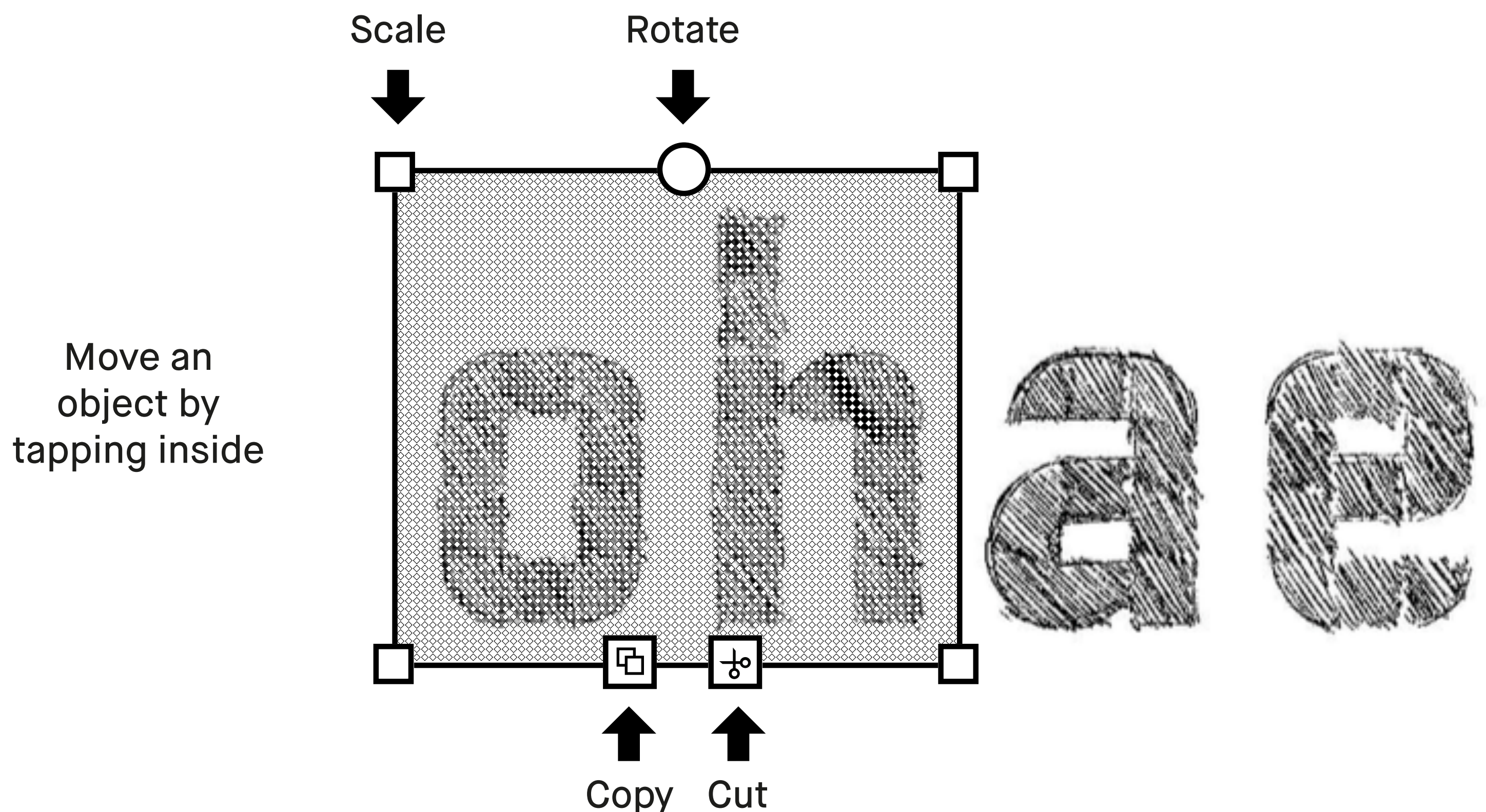

📄 Copy to clipboard. Tap any pages with Marker to paste.

Note Notification at the bottom of the screen will appear if there is something on the clipboard.

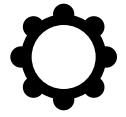

Setting

In the menu, bottom left you will find the **Setting**, here you can overview of **Device setting**, **Account setting**, **Wi-fi setting**, **DevicePower**, **Storage**, **Security setting**, **Handwriting conversion setting**, **Keyboard setting**, **Accessiblity setting**, **About and Tutorial**.

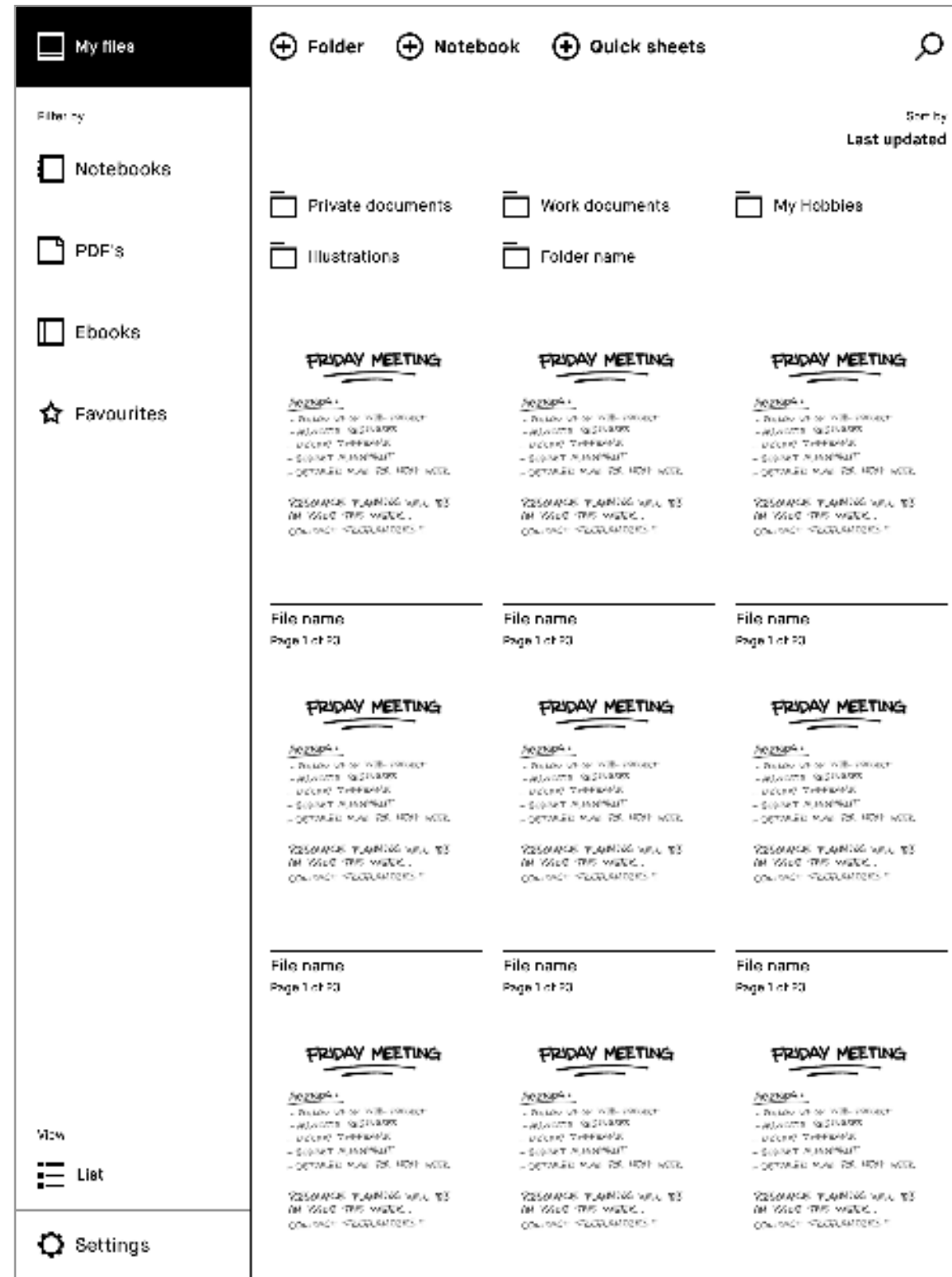

Setting →

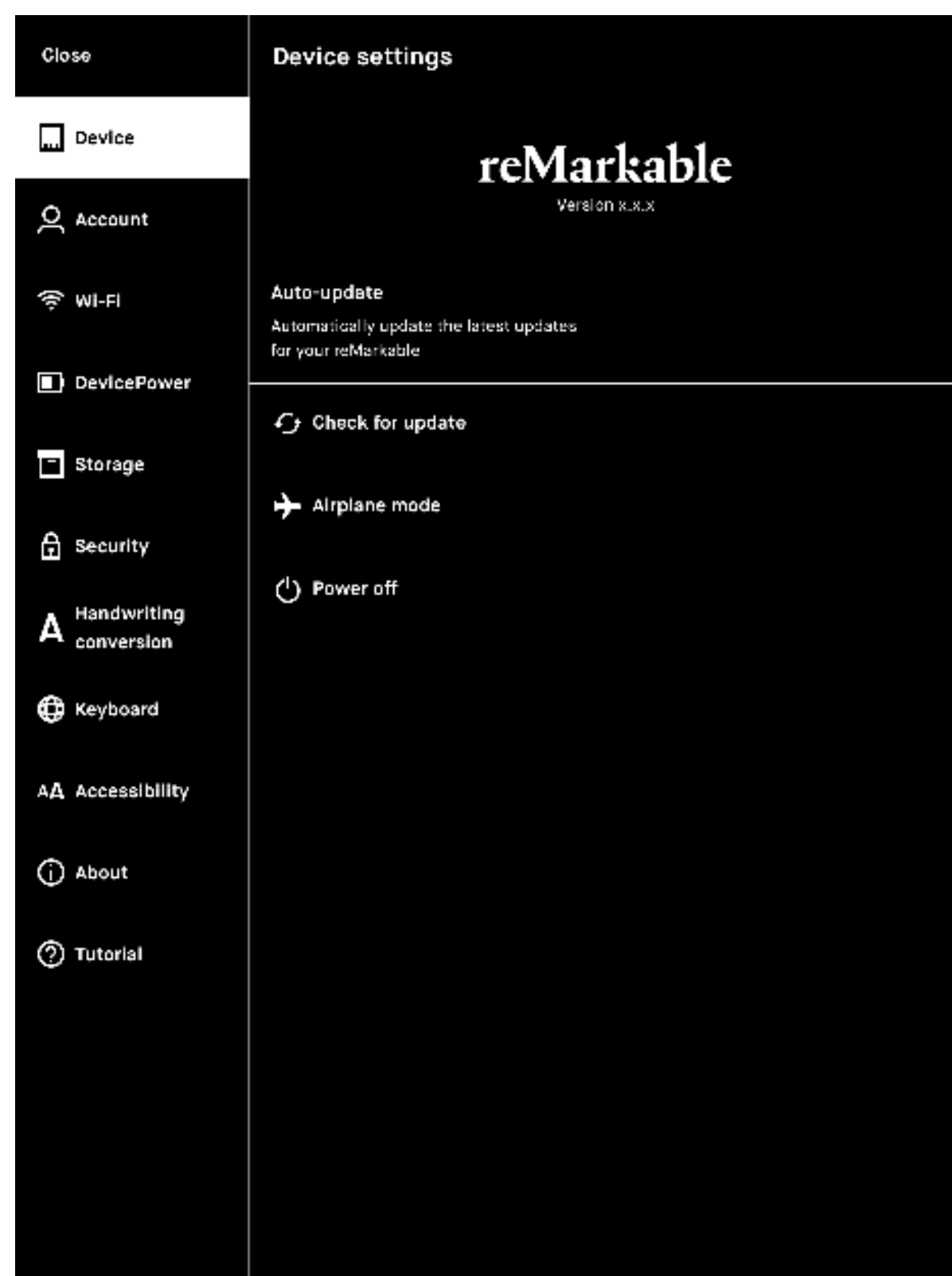

Filter by

Sort by Last updated

Notebooks

PDF's

Ebooks

Favourites

Private documents

Work documents

My Hobbies

Illustrations

Folder name

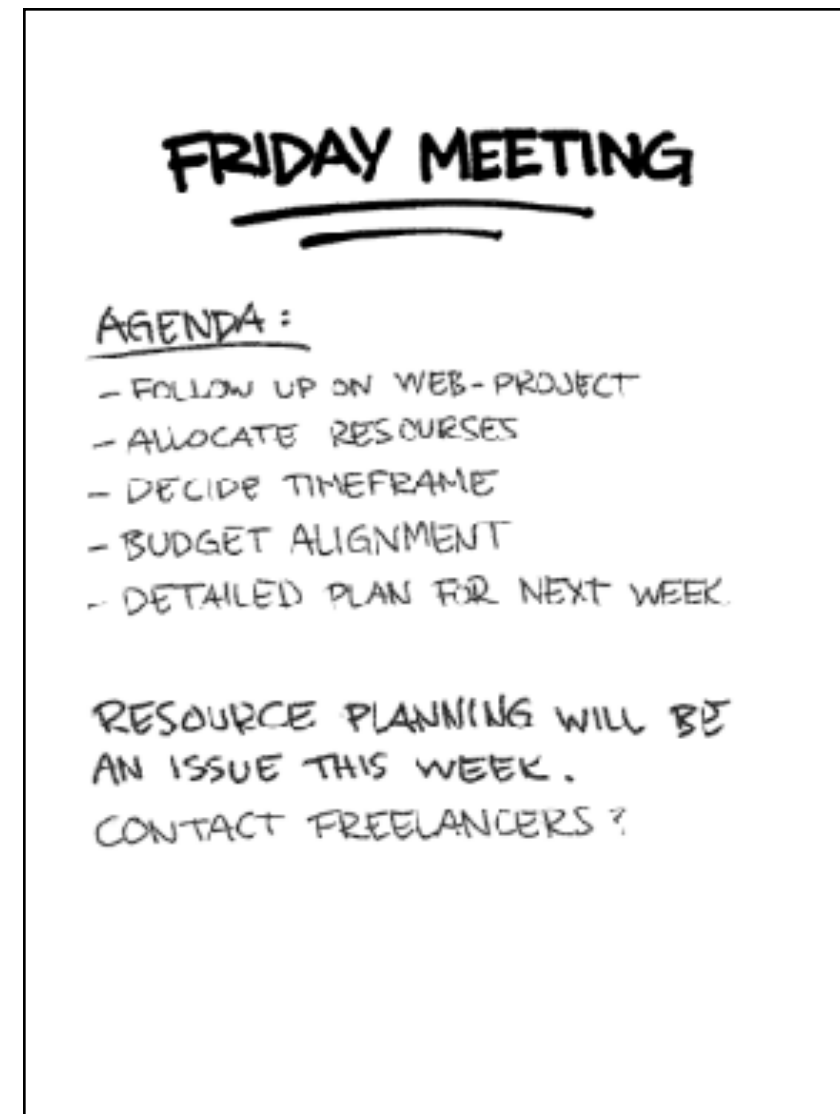

File name

Page 1 of 23

File name

Page 1 of 23

File name

Page 1 of 23



File name

Page 1 of 23

File name

Page 1 of 23

File name

Page 1 of 23



View

List

Settings

My files

Sort by Last updated

Private documents

Work documents

My hobbies

Illustration

The folder with the ..

Folder name

Folder name



File name

Page 1 of 23

File name

Page 1 of 23

File name

Page 1 of 23

File name

Page 1 of 23



File name

Page 1 of 23

File name

Page 1 of 23

File name

Page 1 of 23

File name

Page 1 of 23



My files

Sort by **Last updated**



Private documents

4 documents



Work documents

4 documents



My hobbies

4 documents



Illustration

4 documents



The folder with the stupidly long name for no reason

4 documents



Folder label

4 documents



Folder label

4 documents



File name

Steven Spielberg

Penguin publishing

1997

54 pages (5 hours ago)



File name

Steven Spielberg

Penguin publishing

1997

Page 1 of 25 (5 hours ago)



File name

Steven Spielberg

Penguin publishing

1997

Page 1 of 25 (5 hours ago)



File name

Steven Spielberg

Penguin publishing

1997

Page 1 of 25 (5 hours ago)



File name

Steven Spielberg

Penguin publishing

1997

54 pages (5 hours ago)



File name

Steven Spielberg

Penguin publishing

1997

54 pages (5 hours ago)



File name

Steven Spielberg

Penguin publishing

1997

54 pages (5 hours ago)



File name

Steven Spielberg

Penguin publishing

1997

54 pages (5 hours ago)

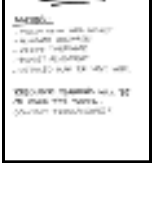

File name

Steven Spielberg

Penguin publishing

1997

Page 1 of 25 (5 hours ago)



File name

Steven Spielberg

Penguin publishing

1997

54 pages (5 hours ago)

My files

Sort by Last updated

Folder name

Private documents

Work documents

My Hobbies

That folde...long

Illustrations

Folder name

FRIDAY MEETING

AGENDA :

- FOLLOW UP ON WEB-PROJECT
- ALLOCATE RESOURCES
- DECIDE TIMEFRAME
- BUDGET ALIGNMENT
- DETAILED PLAN FOR NEXT WEEK.

RESOURCE PLANNING WILL BE AN ISSUE THIS WEEK.
CONTACT FREELANCERS ?

File name
Page 1 of 23

FRIDAY MEETING

AGENDA :

- FOLLOW UP ON WEB-PROJECT
- ALLOCATE RESOURCES
- DECIDE TIMEFRAME
- BUDGET ALIGNMENT
- DETAILED PLAN FOR NEXT WEEK.

RESOURCE PLANNING WILL BE AN ISSUE THIS WEEK.
CONTACT FREELANCERS ?

File name
Page 1 of 23

FRIDAY MEETING

AGENDA :

- FOLLOW UP ON WEB-PROJECT
- ALLOCATE RESOURCES
- DECIDE TIMEFRAME
- BUDGET ALIGNMENT
- DETAILED PLAN FOR NEXT WEEK.

RESOURCE PLANNING WILL BE AN ISSUE THIS WEEK.
CONTACT FREELANCERS ?

File name
Page 1 of 23

FRIDAY MEETING

AGENDA :

- FOLLOW UP ON WEB-PROJECT
- ALLOCATE RESOURCES
- DECIDE TIMEFRAME
- BUDGET ALIGNMENT
- DETAILED PLAN FOR NEXT WEEK.

RESOURCE PLANNING WILL BE AN ISSUE THIS WEEK.
CONTACT FREELANCERS ?

File name
Page 1 of 23

FRIDAY MEETING

AGENDA :

- FOLLOW UP ON WEB-PROJECT
- ALLOCATE RESOURCES
- DECIDE TIMEFRAME
- BUDGET ALIGNMENT
- DETAILED PLAN FOR NEXT WEEK.

RESOURCE PLANNING WILL BE AN ISSUE THIS WEEK.
CONTACT FREELANCERS ?

File name
Page 1 of 23

FRIDAY MEETING

AGENDA :

- FOLLOW UP ON WEB-PROJECT
- ALLOCATE RESOURCES
- DECIDE TIMEFRAME
- BUDGET ALIGNMENT
- DETAILED PLAN FOR NEXT WEEK.

RESOURCE PLANNING WILL BE AN ISSUE THIS WEEK.
CONTACT FREELANCERS ?

File name
Page 1 of 23

FRIDAY MEETING

AGENDA :

- FOLLOW UP ON WEB-PROJECT
- ALLOCATE RESOURCES
- DECIDE TIMEFRAME
- BUDGET ALIGNMENT
- DETAILED PLAN FOR NEXT WEEK.

RESOURCE PLANNING WILL BE AN ISSUE THIS WEEK.
CONTACT FREELANCERS ?

File name
Page 1 of 23

FRIDAY MEETING

AGENDA :

- FOLLOW UP ON WEB-PROJECT
- ALLOCATE RESOURCES
- DECIDE TIMEFRAME
- BUDGET ALIGNMENT
- DETAILED PLAN FOR NEXT WEEK.

RESOURCE PLANNING WILL BE AN ISSUE THIS WEEK.
CONTACT FREELANCERS ?

File name
Page 1 of 23

FRIDAY MEETING

AGENDA :

- FOLLOW UP ON WEB-PROJECT
- ALLOCATE RESOURCES
- DECIDE TIMEFRAME
- BUDGET ALIGNMENT
- DETAILED PLAN FOR NEXT WEEK.

RESOURCE PLANNING WILL BE AN ISSUE THIS WEEK.
CONTACT FREELANCERS ?

FRIDAY MEETING

AGENDA :

- FOLLOW UP ON WEB-PROJECT
- ALLOCATE RESOURCES
- DECIDE TIMEFRAME
- BUDGET ALIGNMENT
- DETAILED PLAN FOR NEXT WEEK.

RESOURCE PLANNING WILL BE AN ISSUE THIS WEEK.
CONTACT FREELANCERS ?

FRIDAY MEETING

AGENDA :

- FOLLOW UP ON WEB-PROJECT
- ALLOCATE RESOURCES
- DECIDE TIMEFRAME
- BUDGET ALIGNMENT
- DETAILED PLAN FOR NEXT WEEK.

RESOURCE PLANNING WILL BE AN ISSUE THIS WEEK.
CONTACT FREELANCERS ?

FRIDAY MEETING

AGENDA :

- FOLLOW UP ON WEB-PROJECT
- ALLOCATE RESOURCES
- DECIDE TIMEFRAME
- BUDGET ALIGNMENT
- DETAILED PLAN FOR NEXT WEEK.

RESOURCE PLANNING WILL BE AN ISSUE THIS WEEK.
CONTACT FREELANCERS ?

Cancel



Convert to text



Send

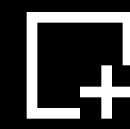

Add page

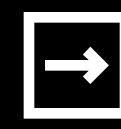

move



Duplicate

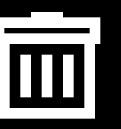

Delete

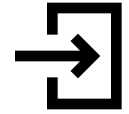

Go to page

View

Grid

FRIDAY MEETING

AGENDA:

- FOLLOW UP ON WEB-PROJECT
- ALLOCATE RESOURCES
- DECIDE TIMEFRAME
- BUDGET ALIGNMENT
- DETAILED PLAN FOR NEXT WEEK.

RESOURCE PLANNING WILL BE AN ISSUE THIS WEEK.
CONTACT FREELANCERS?

Page 1

FRIDAY MEETING

AGENDA:

- FOLLOW UP ON WEB-PROJECT
- ALLOCATE RESOURCES
- DECIDE TIMEFRAME
- BUDGET ALIGNMENT
- DETAILED PLAN FOR NEXT WEEK.

RESOURCE PLANNING WILL BE AN ISSUE THIS WEEK.
CONTACT FREELANCERS?

Page 2 (current)

FRIDAY MEETING

AGENDA:

- FOLLOW UP ON WEB-PROJECT
- ALLOCATE RESOURCES
- DECIDE TIMEFRAME
- BUDGET ALIGNMENT
- DETAILED PLAN FOR NEXT WEEK.

RESOURCE PLANNING WILL BE AN ISSUE THIS WEEK.
CONTACT FREELANCERS?

Page 3

FRIDAY MEETING

AGENDA:

- FOLLOW UP ON WEB-PROJECT
- ALLOCATE RESOURCES
- DECIDE TIMEFRAME
- BUDGET ALIGNMENT
- DETAILED PLAN FOR NEXT WEEK.

RESOURCE PLANNING WILL BE AN ISSUE THIS WEEK.
CONTACT FREELANCERS?

Page 4

Cancel



Convert to text



Send

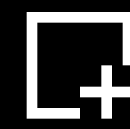

Add page

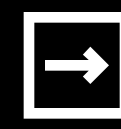

move



Duplicate

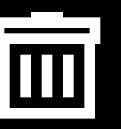

Delete

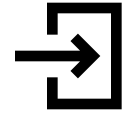

Go to page

View

Grid

FRIDAY MEETING

AGENDA:

- FOLLOW UP ON WEB-PROJECT
- ALLOCATE RESOURCES
- DECIDE TIMEFRAME
- BUDGET ALIGNMENT
- DETAILED PLAN FOR NEXT WEEK.

RESOURCE PLANNING WILL BE AN ISSUE THIS WEEK.
CONTACT FREELANCERS ?

FRIDAY MEETING

AGENDA:

- FOLLOW UP ON WEB-PROJECT
- ALLOCATE RESOURCES
- DECIDE TIMEFRAME
- BUDGET ALIGNMENT
- DETAILED PLAN FOR NEXT WEEK.

RESOURCE PLANNING WILL BE AN ISSUE THIS WEEK.
CONTACT FREELANCERS ?

FRIDAY MEETING

AGENDA:

- FOLLOW UP ON WEB-PROJECT
- ALLOCATE RESOURCES
- DECIDE TIMEFRAME
- BUDGET ALIGNMENT
- DETAILED PLAN FOR NEXT WEEK.

RESOURCE PLANNING WILL BE AN ISSUE THIS WEEK.
CONTACT FREELANCERS ?

FRIDAY MEETING

AGENDA:

- FOLLOW UP ON WEB-PROJECT
- ALLOCATE RESOURCES
- DECIDE TIMEFRAME
- BUDGET ALIGNMENT
- DETAILED PLAN FOR NEXT WEEK.

RESOURCE PLANNING WILL BE AN ISSUE THIS WEEK.
CONTACT FREELANCERS ?

Page 1

Page 2 (current)

Page 3

Page 4

My files

Sort by
Last updated

Folder name

Folder name

Folder name

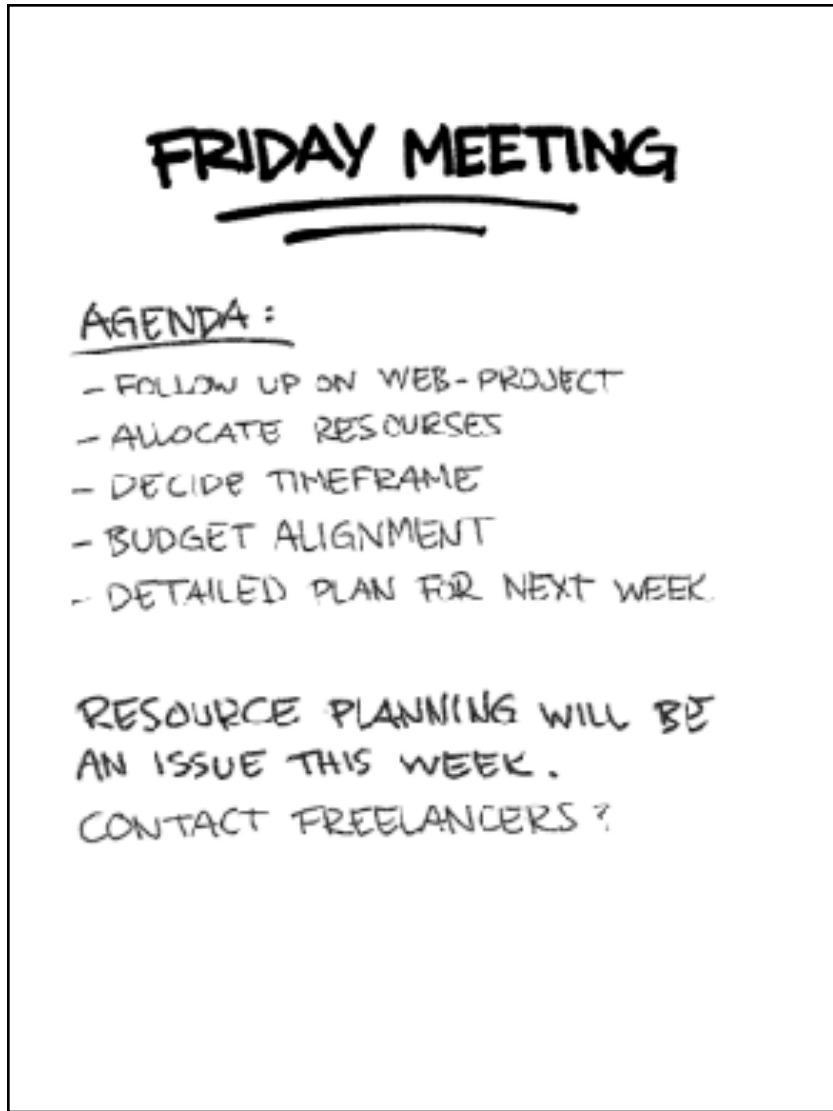

Quick sheets

42 pages

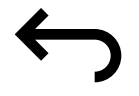
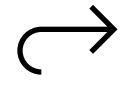
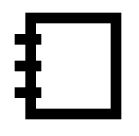

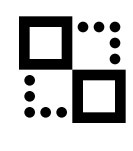
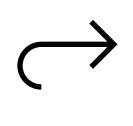
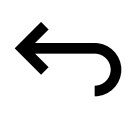

Live view (beta)

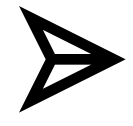

Send notebook pages



Convert to text and send

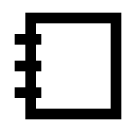

Go to page

View Grid

FRIDAY MEETING

AGENDA :

- FOLLOW UP ON WEB-PROJECT
- ALLOCATE RESOURCES
- DECIDE TIMEFRAME
- BUDGET ALIGNMENT
- DETAILED PLAN FOR NEXT WEEK.

RESOURCE PLANNING WILL BE AN ISSUE THIS WEEK.
CONTACT FREELANCERS ?

Page 1

FRIDAY MEETING

AGENDA :

- FOLLOW UP ON WEB-PROJECT
- ALLOCATE RESOURCES
- DECIDE TIMEFRAME
- BUDGET ALIGNMENT
- DETAILED PLAN FOR NEXT WEEK.

RESOURCE PLANNING WILL BE AN ISSUE THIS WEEK.
CONTACT FREELANCERS ?

Page 2

FRIDAY MEETING

AGENDA :

- FOLLOW UP ON WEB-PROJECT
- ALLOCATE RESOURCES
- DECIDE TIMEFRAME
- BUDGET ALIGNMENT
- DETAILED PLAN FOR NEXT WEEK.

RESOURCE PLANNING WILL BE AN ISSUE THIS WEEK.
CONTACT FREELANCERS ?

Page 3

FRIDAY MEETING

AGENDA :

- FOLLOW UP ON WEB-PROJECT
- ALLOCATE RESOURCES
- DECIDE TIMEFRAME
- BUDGET ALIGNMENT
- DETAILED PLAN FOR NEXT WEEK.

RESOURCE PLANNING WILL BE AN ISSUE THIS WEEK.
CONTACT FREELANCERS ?

Page 4

FRIDAY MEETING

AGENDA :

- FOLLOW UP ON WEB-PROJECT
- ALLOCATE RESOURCES
- DECIDE TIMEFRAME
- BUDGET ALIGNMENT
- DETAILED PLAN FOR NEXT WEEK.

RESOURCE PLANNING WILL BE AN ISSUE THIS WEEK.
CONTACT FREELANCERS ?

Page 5

FRIDAY MEETING

AGENDA :

- FOLLOW UP ON WEB-PROJECT
- ALLOCATE RESOURCES
- DECIDE TIMEFRAME
- BUDGET ALIGNMENT
- DETAILED PLAN FOR NEXT WEEK.

RESOURCE PLANNING WILL BE AN ISSUE THIS WEEK.
CONTACT FREELANCERS ?

Page 6 (current)

FRIDAY MEETING

AGENDA :

- FOLLOW UP ON WEB-PROJECT
- ALLOCATE RESOURCES
- DECIDE TIMEFRAME
- BUDGET ALIGNMENT
- DETAILED PLAN FOR NEXT WEEK.

RESOURCE PLANNING WILL BE AN ISSUE THIS WEEK.
CONTACT FREELANCERS ?

Page 7

FRIDAY MEETING

AGENDA :

- FOLLOW UP ON WEB-PROJECT
- ALLOCATE RESOURCES
- DECIDE TIMEFRAME
- BUDGET ALIGNMENT
- DETAILED PLAN FOR NEXT WEEK.

RESOURCE PLANNING WILL BE AN ISSUE THIS WEEK.
CONTACT FREELANCERS ?

Page 8

FRIDAY MEETING

AGENDA :

- FOLLOW UP ON WEB-PROJECT
- ALLOCATE RESOURCES
- DECIDE TIMEFRAME
- BUDGET ALIGNMENT
- DETAILED PLAN FOR NEXT WEEK.

RESOURCE PLANNING WILL BE AN ISSUE THIS WEEK.
CONTACT FREELANCERS ?

Page 9

FRIDAY MEETING

AGENDA :

- FOLLOW UP ON WEB-PROJECT
- ALLOCATE RESOURCES
- DECIDE TIMEFRAME
- BUDGET ALIGNMENT
- DETAILED PLAN FOR NEXT WEEK.

RESOURCE PLANNING WILL BE AN ISSUE THIS WEEK.
CONTACT FREELANCERS ?

Page 10

FRIDAY MEETING

AGENDA :

- FOLLOW UP ON WEB-PROJECT
- ALLOCATE RESOURCES
- DECIDE TIMEFRAME
- BUDGET ALIGNMENT
- DETAILED PLAN FOR NEXT WEEK.

RESOURCE PLANNING WILL BE AN ISSUE THIS WEEK.
CONTACT FREELANCERS ?

Page 11

FRIDAY MEETING

AGENDA :

- FOLLOW UP ON WEB-PROJECT
- ALLOCATE RESOURCES
- DECIDE TIMEFRAME
- BUDGET ALIGNMENT
- DETAILED PLAN FOR NEXT WEEK.

RESOURCE PLANNING WILL BE AN ISSUE THIS WEEK.
CONTACT FREELANCERS ?

Page 12

FRIDAY MEETING

FRIDAY MEETING

FRIDAY MEETING

FRIDAY MEETING

Recently used

- ⊕ ola.nordmann@remarkable.com
- ⊕ Jonny@remarkable.com
- ⊕ danny.jones@remarkable.com

Clear all

Send to

- ⊕ Add email adress

Subject

Meeting notes

Edit

Reset

Text settings

Done

Font size

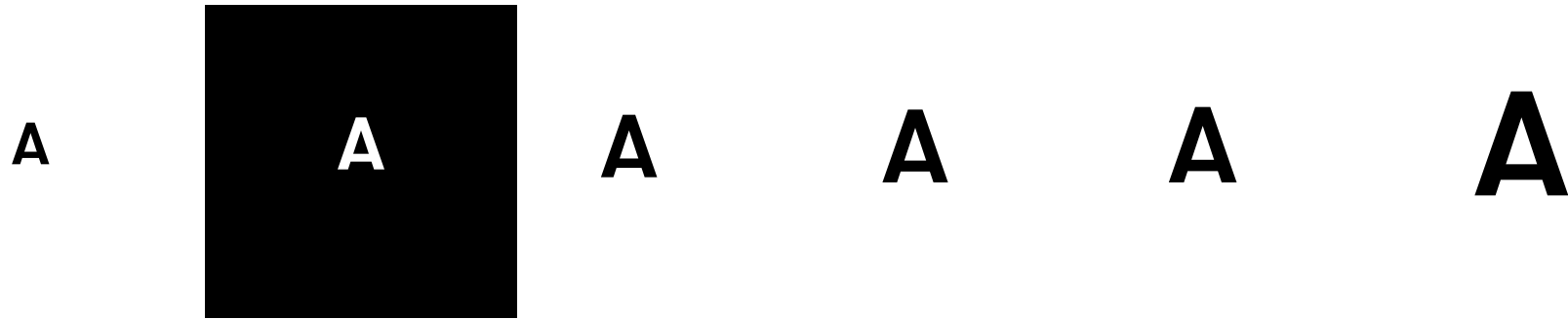

Font

- Maison Neue
- Noto Sans
- Noto Mono
- Christoffel Rough
- Noto Serif
- Noto Sans UI

Justification

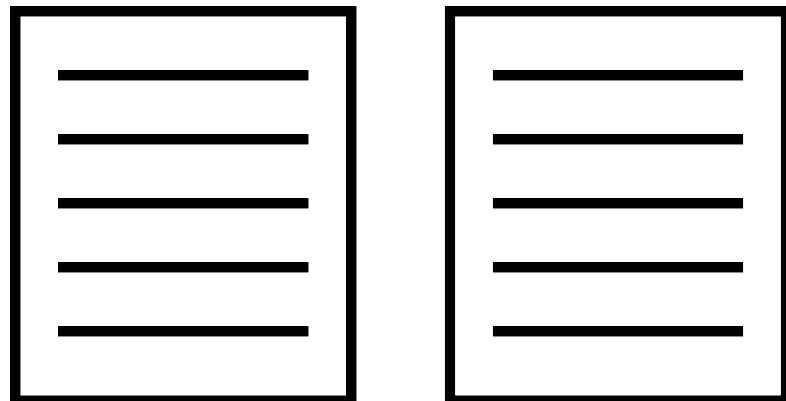

Page margins

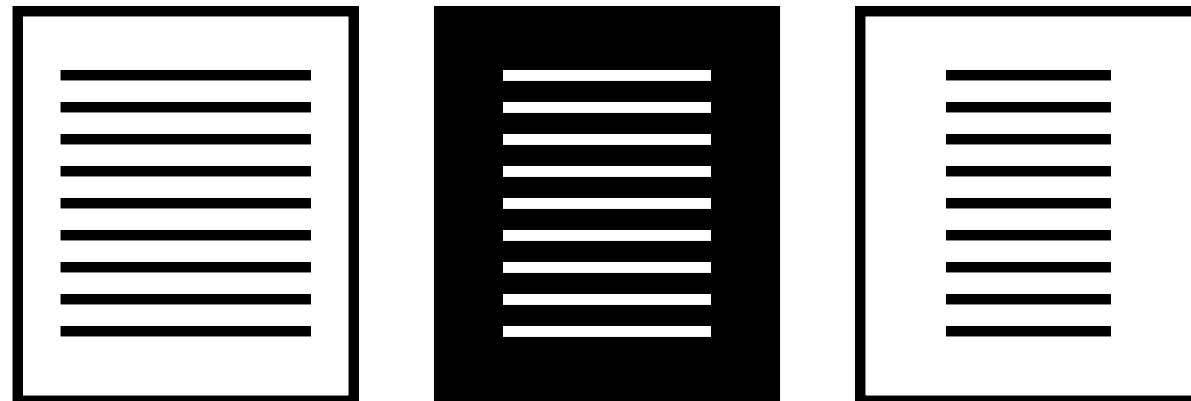

Line spacing

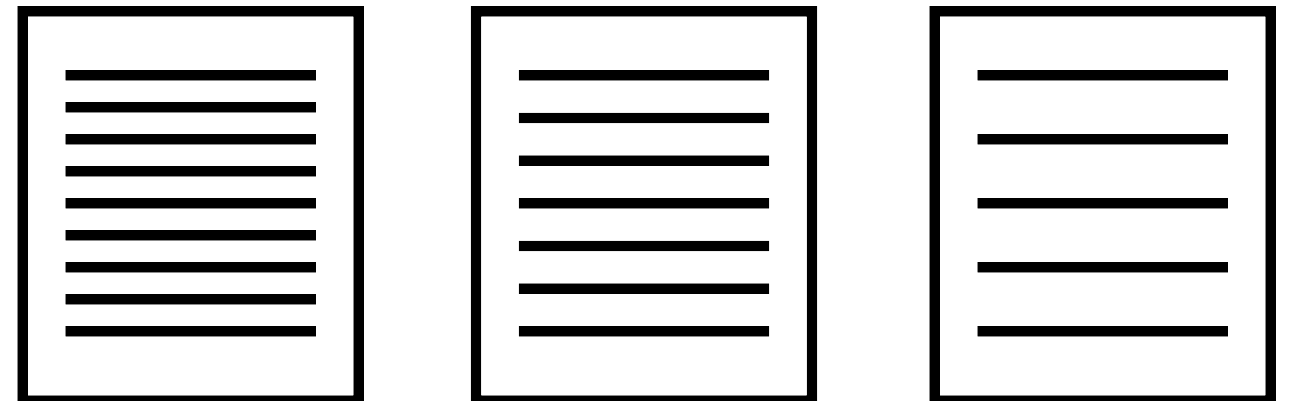

Reset

Text settings

Done

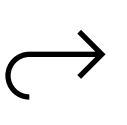
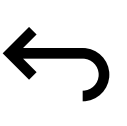
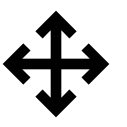
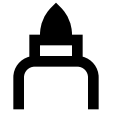

PDF Name
Page 4 of 157



 Set to landscape view

 Search

 Page overview

 Adjust view

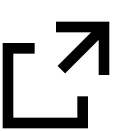

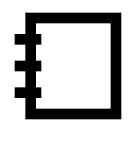
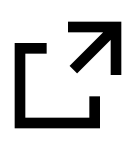
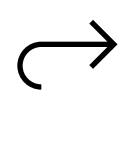
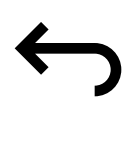

	Layer 1		
	Template - Lined medium		
	Add layer		

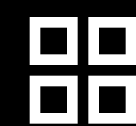

Lorem ipsum dolor sit amet, at has conceptam adipiscing, ut animal convenire nec. Nam singulis deserunt at, noluisse fabellas sea eu. Nec ei amet everti argumentum, aeterno tibi que in pri, ex duis convenire accommodare pro. Ea his simul temporibus, sit quot legendos no, tritani nominavi intellegebat id eum. Duo ea regione offendit consecutur.

At pri case ornatus neglegentur, amet dicit aliquid duo an, mel no case nobis. Quas ignota conclusionemque cu sit, qui at utinam fabellas consequuntur. Facer tation omittantur per ne, at copiosae electram suscipiantur his. Omnes albucius mel ei, at eam graece expetenda dignissim. Vix te omnes ignota. Nibh legendos scriptorem at cum, te vim elit altera.

Cancel

Share via email

Recently used

 ola.nordmann@remarkable.com  Jonny@remarkable.com

 danny.jones@remarkable.com

Send to

 Add email address

Message

 Add message

Filename

Meeting notes

Edit

Export

All pages

Edit

Export format

PDF

PNG

SVG

Close

Device settings

 Device

reMarkable

Version x.x.x

 Account

 Wi-Fi

Auto-update

Automatically update the latest updates
for your reMarkable

 Device Power

 Check for update

 Storage

 Airplane mode

 Security

 Power off

 Handwriting
conversion

 Keyboard

 Accessibility

 About

 Tutorial

Touch gestures

Home screen

Create screen

Settings

Tap

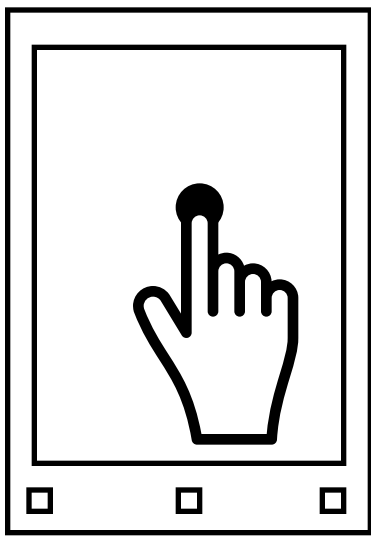

Activates a controll or selects an item.

Activates a controll or selects an item.

Activates a controll or selects an item.

Long-press

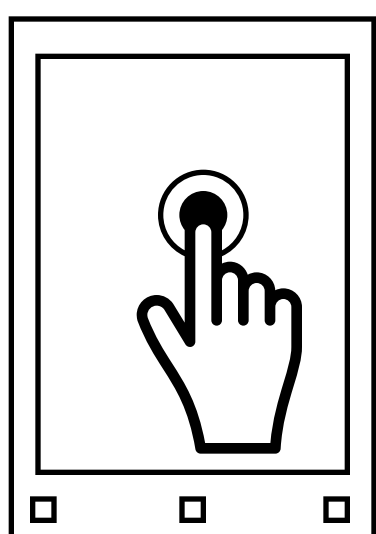

Options

Select a document or folder by long-press to view the document options menu.

Options

In page overview, select a page by long-press to view the page options menu.

N/A

Pull down

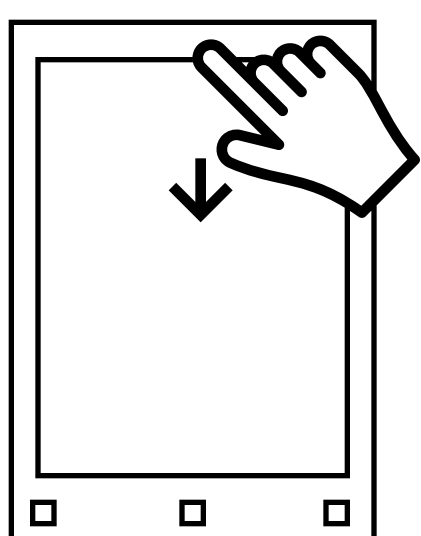

N/A

Close document

Swipe down from the top edge of the screen to close a document.

N/A

Horizontal swipe

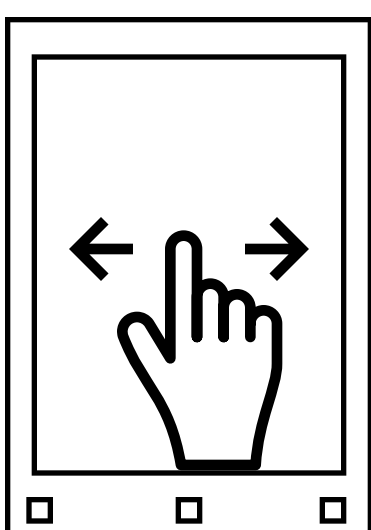

N/A

Turn pages

Swipe left or right to navigate the pages of a document.

N/A

Add page to Notebook

When at the last page of a notebook swiping left adds a page (but only if the current last page has any content)

Vertical swipe

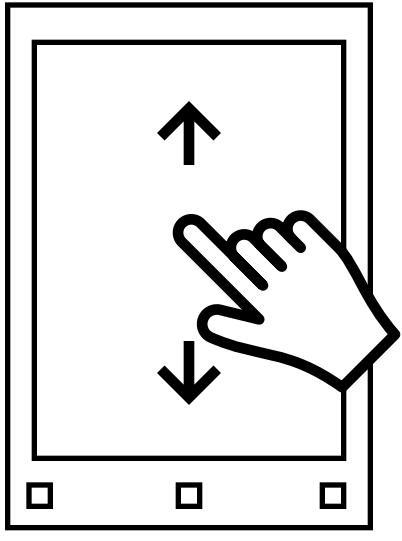

Home screen

Scroll documents

Swipe up or down to scroll through content on the home screen.

Create screen

HWC editing scroll

When handwriting is converted, swipe can be used to scroll the result if it goes below the fold.

Scroll pages

Swipe up or down to scroll through pages in page overview.

Settings

Scroll content

Scroll through settings, when they go below the fold.