

I. Product parameters

a. Compatible mobile phone system: Android5.0 (inclusive) or higher, iOS9.0 (inclusive) or higher

b. Main control:RTL8763EWE-VP

c. Screen: 1.43 AMOLED Round Screen Resolution: 466*466

II. Operating instructions

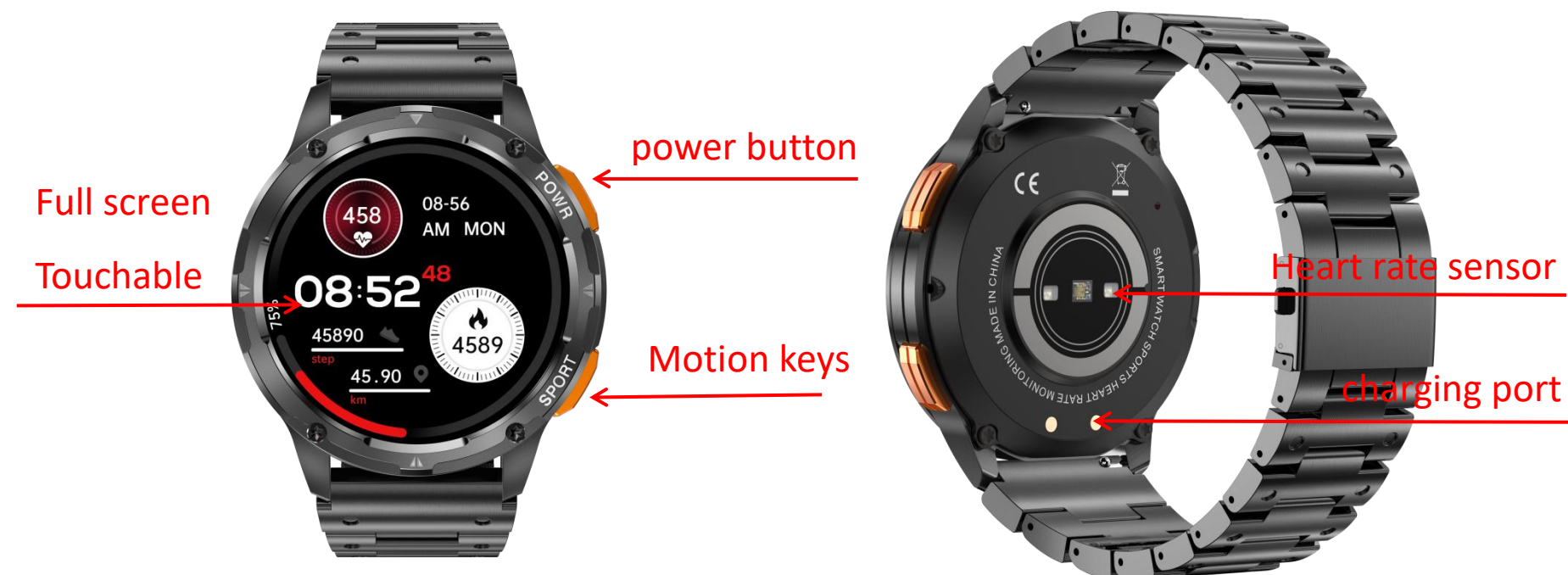

1. Button operation

Status/Operation	Function
power button: power off/long press for 5 seconds	power on
power button: power on/long press for 3 seconds	power off
Power on button: Short press	Enter the main interface
Power on button: Short press	Return to the main interface
Exercise key: Short press	Enter sport mode

2.Screen operation

Status/Operation	Function
single click	Select / OK
home page/long press for 3 seconds	switch dial
home page/slide up	message list
home page/slide down	Shortcut menu
home page/slide left	Call/Voice assistant/Motion recording/Sleep information/Heart rate monitoring/Blood pressure monitoring/Weather/Music/Add components
home page/slide right	enter home page

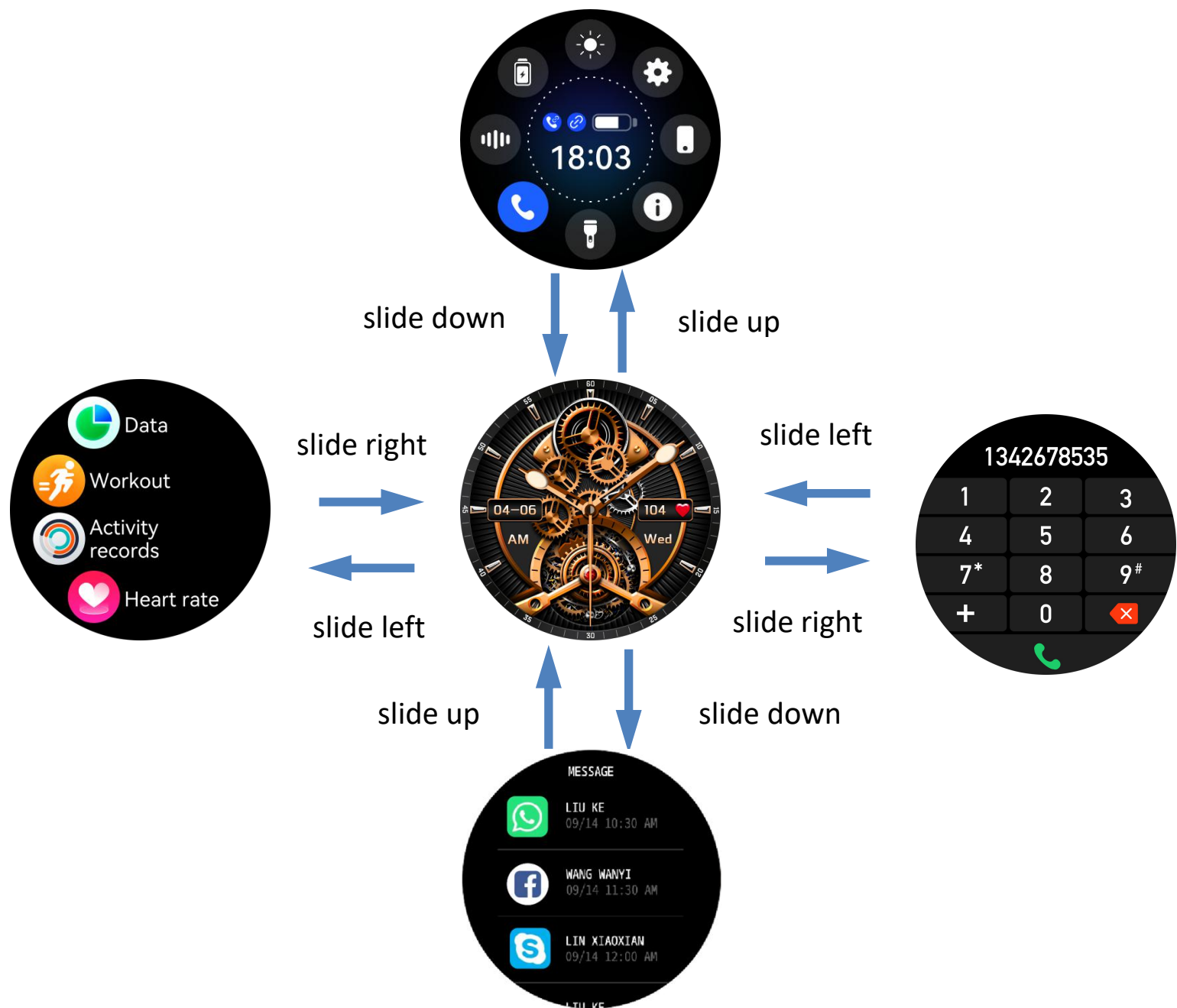

3. Charging instructions

a. Please use the charging cradle equipped with the product to align the contacts on the back of the host to charge (please ensure that the battery is sufficient for the first use. If the battery cannot be turned on normally at low power, please charge it before operating. Please charge correctly as shown in the right picture)

b. Do not use a power adapter with an output current of more than 2A to charge

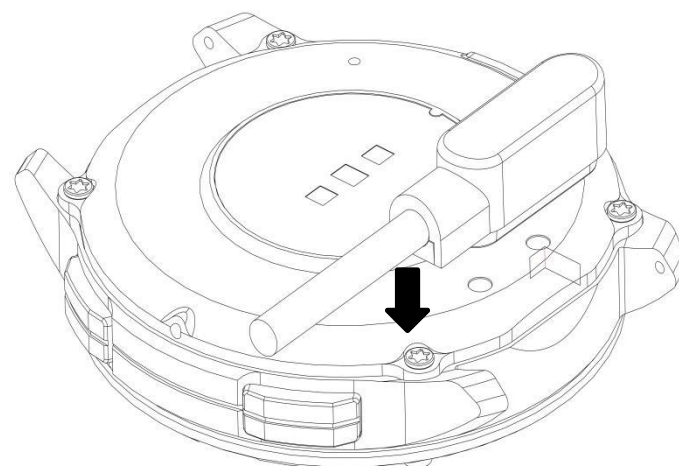

4. Download and install the "FitCloudPro" APP

1).Scan and install by scanning the QR code on the right

2).Download and install through the app market:
Android system: search for "**FitCloudPro**" through App Store, Google play, Android Market and other app markets to download and install; IOS system: search for "**FitCloudPro**" through the App Store to download and install



5. APP connection

(make sure mobile phone Bluetooth is turned on and not connected with other devices) shortcut menu→settings→about interface, the MAC address of the watch will be displayed, and your device can be determined by the MAC address in the device table. After the watch is successfully bound, the watch will be automatically connected with the mobile phone every time the client is opened in the future. You can synchronize data by pulling down the data page of the client.

Open the mobile client app to set personal



Switch to the device page and click bind



Click your device (AK59) in the scanned



Binding complete

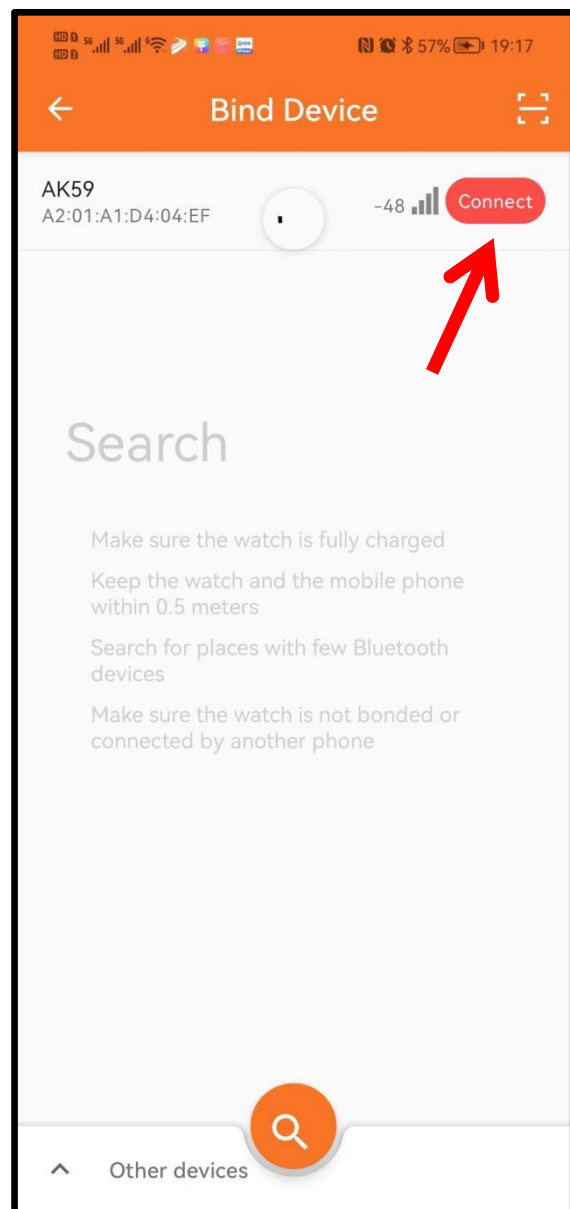
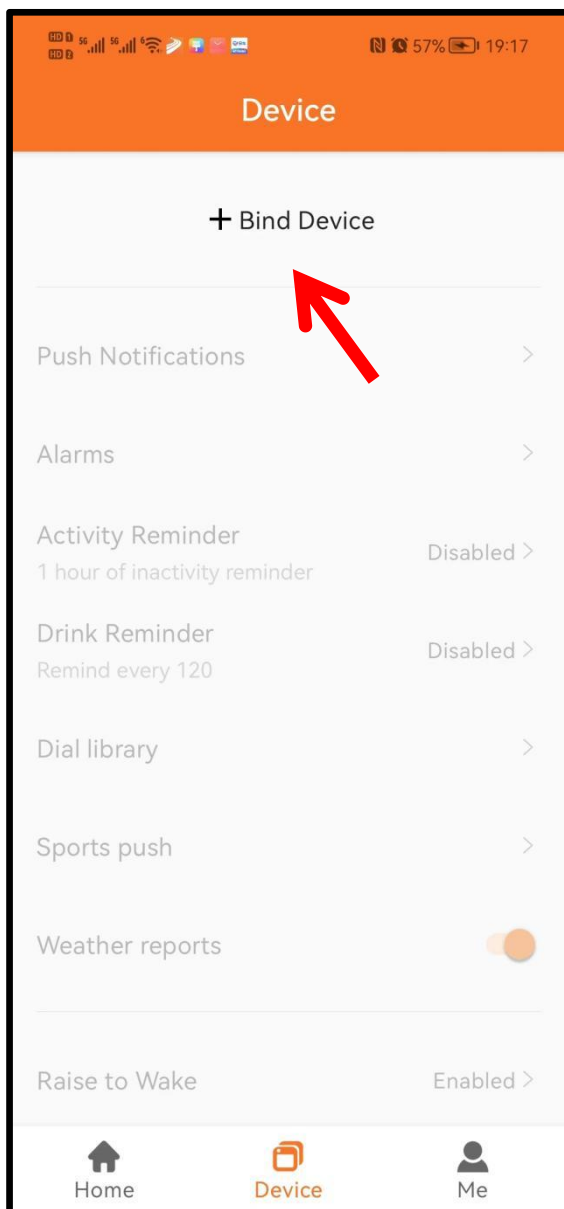

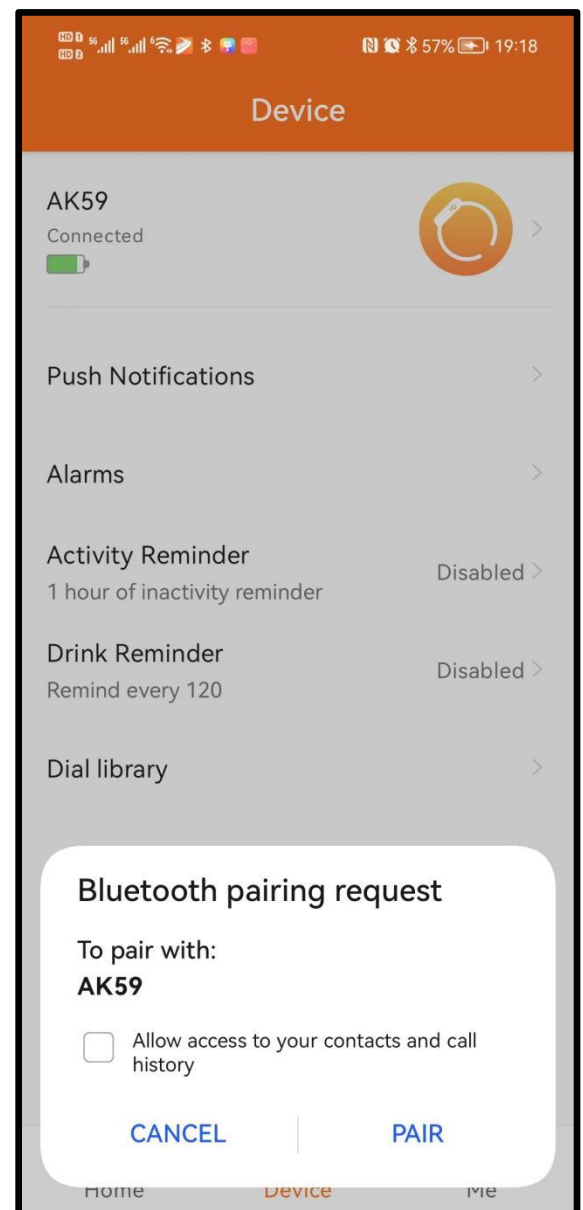
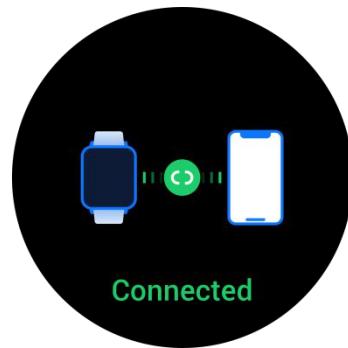
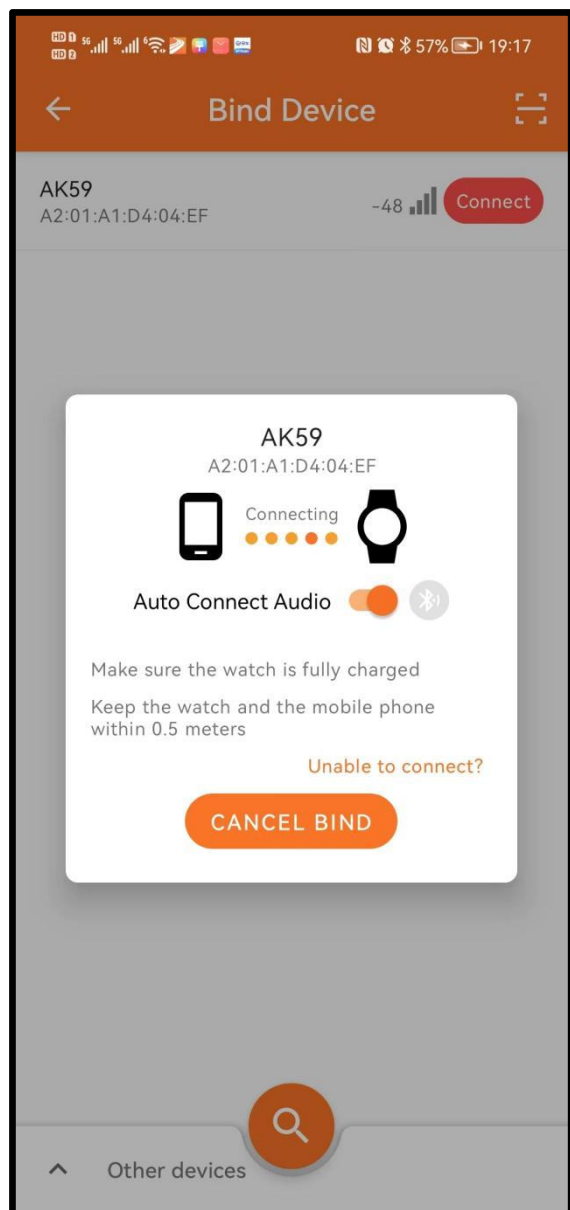

6.Call Bluetooth connection: turn on the watch "TURN ON", and the "AK59 " Bluetooth pairing will pop up automatically in the mobile phone. Click pairing. When Bluetooth is connected to the mobile phone, you can use the watch to dial, control the mobile phone to make a call, listen to music, and view the call record information of the watch.If you click Unpair, when you need to pair the Bluetooth for a call again, open the watch "Enable call function", open the phone settings → Bluetooth option, view all devices, and click "AK59" to connect.

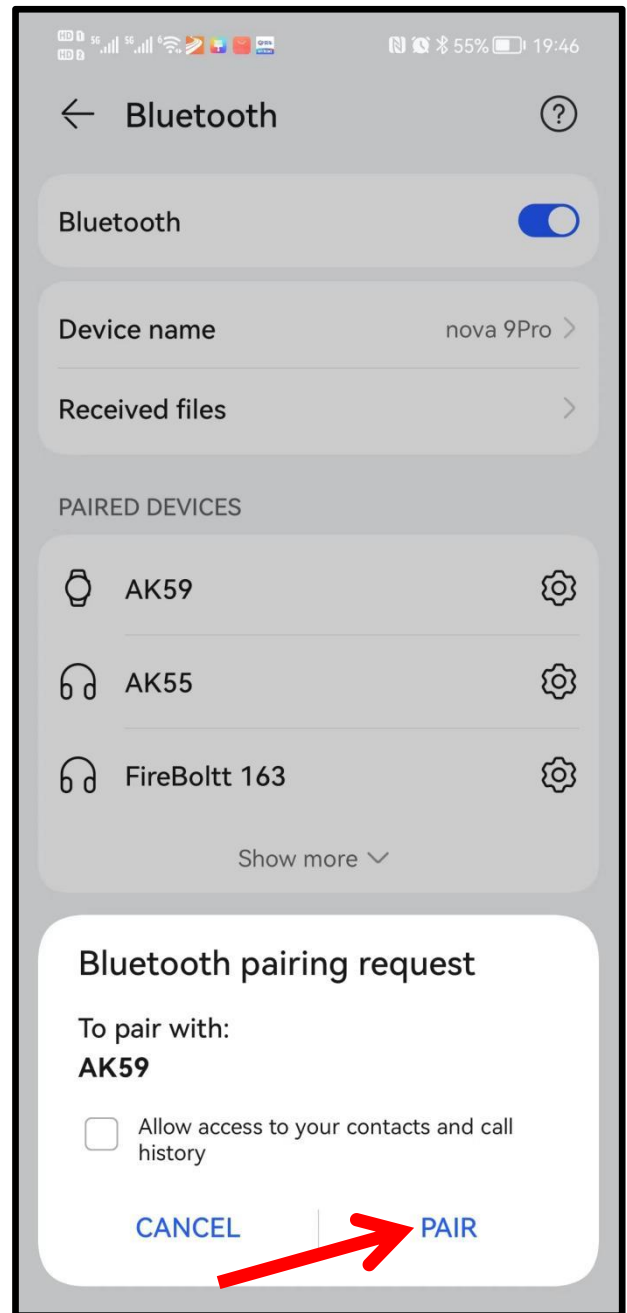
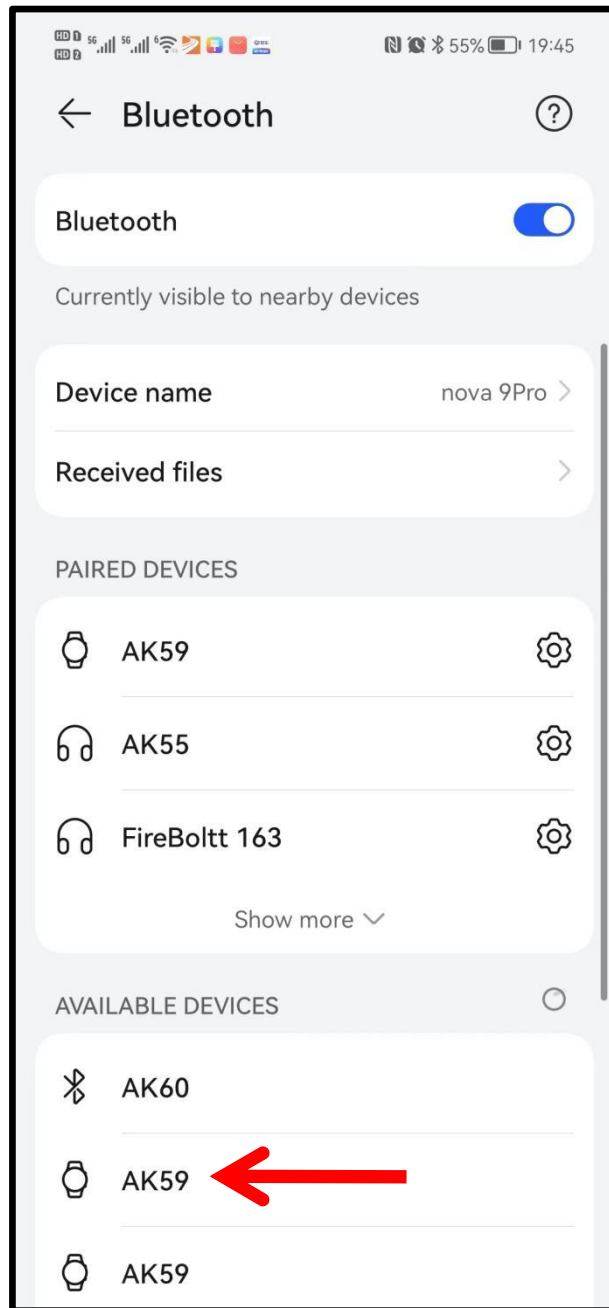
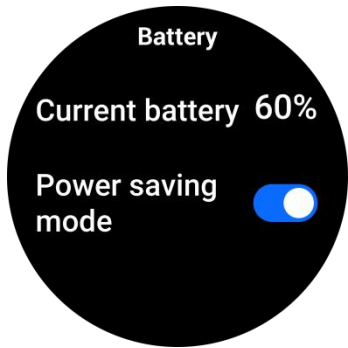

Add contacts: enter the "FitCloudPro" app, click "quick communication" → select contacts to add (at present, up to 10 contacts can be added)

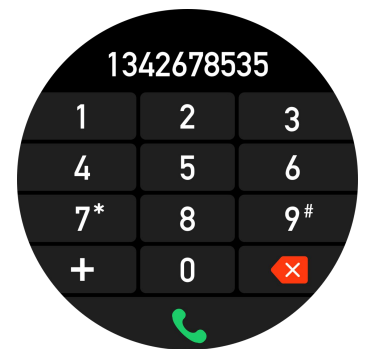

7. Watch function mode

a. Main interface switching: long press the main interface for 3 seconds to enter the selection dial interface, slide left and right to select the main interface, Click to confirm



Custom dial: enter the "FitCloudPro" app and click - > dial selection - > Edit to select the dial you want.

Find more dials: enter the "FitCloudPro" app and click "dial selection" - > more dial settings.

b. The voice assistant is a smart mobile phone application, open it and you can command your mobile phone through smart dialogue, such as sending a message to make a call.

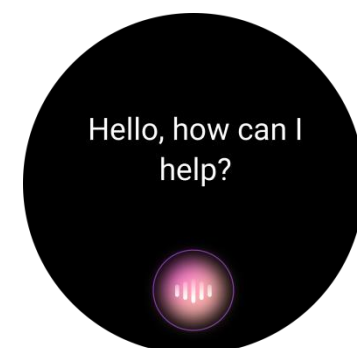

c. **Step counting:** wear the watch normally, and the watch displays the current exercise steps, distance and calories (the data of the day before 0:00 a.m. every day)



d. **Sleep monitoring:** wear a watch to sleep. The watch will automatically monitor the length of deep sleep, light sleep and total time yesterday. The detailed data is displayed on the app side, and the user can view the sleep quality and sleep duration distribution map in the app.

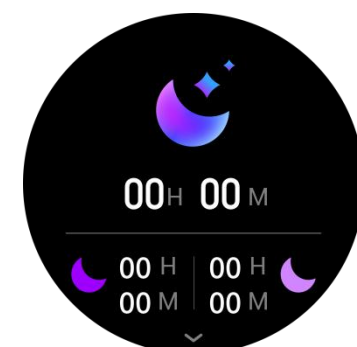

e. **Exercise mode:** Built-in 8+1, push 112 sports modes to choose from: walking, running, cycling, basketball, football, badminton, skipping rope....., open the sports mode and swipe left to select pause/end sports, if you need to add a sports mode, slide down to the end and click to add to select the desired sports mode.



f. **Heart rate measurement:** click the screen in the heart rate interface to measure the current heart rate value. It can also be measured manually on the heart rate interface of APP end (the data is only for reference and not for medical use)



g. Blood pressure: click the screen in the blood pressure interface to measure the current blood pressure value. The icon flashes as in the test and slides right to exit. It can also be measured manually on the app side blood pressure interface (the data is only for reference and not for medical use)

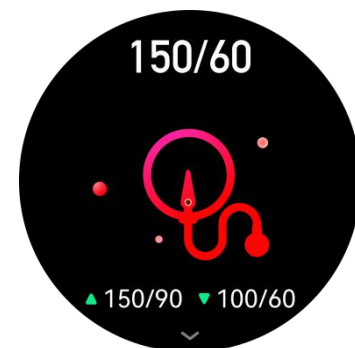

h. Blood oxygen: click the screen in the blood oxygen interface to measure the current blood oxygen value. The flashing icon indicates that the test is in progress, or it can be measured manually on the app end blood oxygen interface (the data is for reference only, not for medical use)

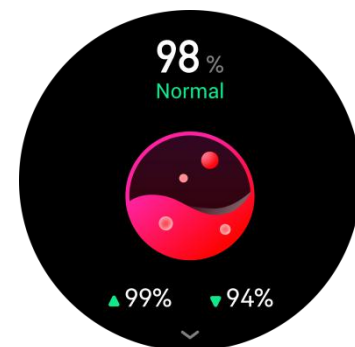

i. Weather: the current weather and air quality information will be displayed on the weather interface. Slide up the weather interface to view the weather conditions in the next 6 days. The weather information can only be obtained after the app is connected. If the connection is disconnected for a long time, the weather information will not be updated.



j. Music control: after connecting the mobile phone, the watch can control the pause / play of mobile phone music, the previous song and the next song.

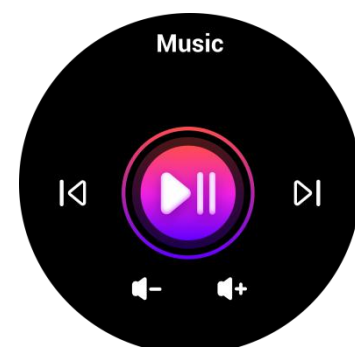

l. Breathing exercise: Sucking function exercise is to carry out effective breathing and strengthen the respiratory muscles. Deep breathing can help you relieve stress.



k. Information push: this watch supports phone / SMS / wechat / Facebook /Twitter/WhatsApp/Skype /other application information push. This page only saves the last 5 information records, and you can turn on the corresponding switch according to your needs. (note that when the Android mobile phone opens the information reminder, it must set the notification right of the app to the mobile phone, otherwise the watch will not receive the reminder)

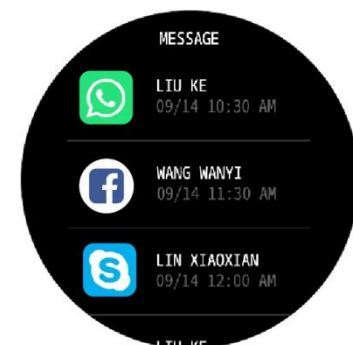

m. Other function interfaces: Other features of the watch include: stopwatch, alarm, timer, women, find phone, calculator, time setting, settings.



Menu view: It is divided into four modes: semi-circular menu style, list menu style, nine-grid menu style, and flat ring menu style.

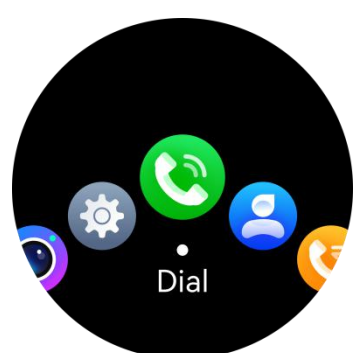

Half-circle menu

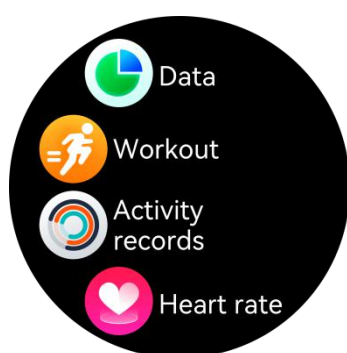

List menu



Nine-grid menu



Circular menu

Note: more detailed analysis and data records can be viewed in the app

Frequently asked questions and answers

Why does the blood pressure value deviate from the sphygmomanometer?

The deviation between the measurement values of the watch and the sphygmomanometer is determined by many factors. The measurement part of the sphygmomanometer is in the brachial artery, and the measurement part of the watch is in the two main public branches of the micro artery. Under normal circumstances, the measurement value of aortic blood pressure and micro

arterial blood pressure will differ by 30 to 40. If you use a watch and a sphygmomanometer to measure at the same time, since the blood flowing in the artery is in the centrifugal direction, when the sphygmomanometer measures, the lower part of your elbow is under pressure, and the blood cannot branch smoothly to the artery below. Flow, increased vascular tension, will make the upper and lower blood pressure measurements more deviations.

Why can't user take a hot bath with the watch?

The ambient temperature during bathing is relatively high, which will produce a lot of water vapor, and the water vapor is gaseous, its molecular radius is small, and it is easy to seep into the gap of the watch. When the temperature drops, it will condense into liquid water droplets again, which is easy to cause The internal circuit of the watch is short-circuited, destroying the circuit board, and then destroying the watch.

Frequently asked questions and answers

Why can't the watch receive the message push

Android phone settings;

Confirm that the message push switch is turned on on the mobile client

The confirmation message can be displayed normally in the mobile phone notification bar. The watch message push is pushed by reading the message in

the mobile phone notification bar. If there is no message in the mobile phone bar, the watch will not be able to receive the push. (You need to find the notification settings in the phone settings, and turn on the notification switch of WeChat, QQ, phone, SMS, and mobile client) Open the accessibility settings of the bracelet client (Find the accessibility in the phone settings, open the accessibility settings of the bracelet client) iPhone settings Confirm that the message push switch is turned on on the mobile client The confirmation message can be displayed normally in the notification bar of the phone (You need to find the notification settings in the phone settings, and turn on the notification switch of WeChat, QQ, phone, SMS, and mobile client)

Precautions

Do not throw this product into the fire to avoid explosion

This product is waterproof only for cold water. If it is used for hot water, it may cause white fog in the lens

The battery life of this product varies with the use environment and use mode

Disclaimer:

This product is not a medical device. The bracelet and its application program are not used for diagnosis, treatment, or prevention of diseases and diseases. If you want to change your habits such as exercise and sleep, you must consult qualified professional medical personnel first to avoid serious casualties. Our company guarantees that without prior notice, The right to modify and improve any function described in this manual, and the company maintains the right to constantly update the product content. All contents shall be subject to the real object