

DENVER[®]

DVD

INSTRUCTION MANUAL

DVH-7787 MK2

IMPORTANT
READ THESE INSTRUCTIONS
BEFORE USE AND RETAIN
FOR FUTURE REFERENCE.
www.denver-electronics.com

IMPORTANT SAFEGUARDS

For your protection, please read these safety instructions completely before operating the appliance, and keep this manual for future reference. Carefully observe all warnings, precautions and instructions on the appliance and in the operating instructions, and adhere to them.

INSTALLATION

Water and Moisture - Do not use powering operated appliances near water - for example, near a bathtub, washbowl, kitchen sink, or laundry tub, in a wet basement, or near a swimming pool, etc.



Heat - Do not place the appliance near or over a radiator or heat register, or where it is exposed to direct sunlight.

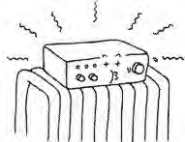

Ventilation - The slots and openings in the cabinet are provided for necessary ventilation. To ensure reliable operation of the appliance, and to protect it from overheating, these slots and openings must never be blocked or covered.

- Never cover the slots and openings with a cloth or other materials.

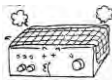

- Never block the slots and openings by placing the appliance on a bed, sofa, rug or other similar surface.



- Never place the appliance in a confined space, such as a bookcase, or built-in cabinet, unless proper ventilation is provided.

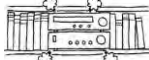

Accessories - Do not place the appliance on an unstable cart, stand, tripod, bracket, or table. The appliance may fall, causing serious injury to a child or an adult, and serious damage to the appliance. Use only a cart, stand, tripod, bracket, or table recommended.



- An appliance and cart combination should be moved with care. Quick stops, excessive force, and uneven surfaces may cause the appliance and cart combination to overturn.



WALL or Ceiling Mounting - If your appliance can be mounted to a wall or ceiling, mount it only as recommended.

USE

Power Source - This appliance should be operated only from the type of power source indicated on the marking label. If you are not sure of the type of electrical power supplied to your home, consult your dealer or local power company. For those appliances designed to operate from battery power, or other sources, refer to the operating instructions.



Grounding or Polarization - This appliance is equipped with a polarized AC power cord Plug (a plug having one blade wider than the other), or with two-wire grounding type plug (Plug having a second pin for grounding).

A follow the instructions below:

- For the appliance with a polarized AC power Cord plug:
This plug will fit into the power outlet only one way. This is a safety feature. If you are unable to insert the plug fully into the outlet, try reversing the plug. If the plug should still fail to fit, contact your electrician to have a suitable outlet Installed. Do not defeat the safety purpose of the Polarized plug by forcing it in.

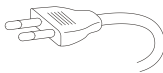

Overloading - Do not overload wall outlets, extension cords or convenience receptacles beyond their capacity, since this can result in fire or electric shock.

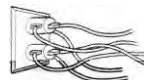

When not in use - Unplug the power cord of the appliance from the outlet when left unused for a long period of time.

To disconnect the cord, pull it out by grasping the plug. Never pull the plug out by the cord.



Power-Cord Protection - Route the power cord so that it is not likely to be walked on or pinched by items placed upon or against them, paying particular attention to the plugs, receptacles, and the point where the cord exits from the appliance.



Lightning - For added protection for this appliance during a lightning storm, or when it is left unattended and unused for long periods of time, unplug it from the wall outlet and disconnect the antenna or cable system. This will prevent damage to the appliance due to lightning and powerline surges.

Cleaning - Unplug the appliance from the wall outlet before cleaning or polishing it. Do not use liquid cleaners or aerosol cleaners. Use a cloth lightly dampened with water for cleaning the exterior of the appliance. Clean the appliance only as recommended.



Object and Liquid Entry - Never push objects of any kind into the appliance through openings as they may touch dangerous voltage points or short out parts that could result in a fire or electric shock. Never spill liquid of any kind on the appliance.



ANTENNAS

Outdoor Antenna Grounding - If an outdoor antenna or cable system is installed, follow the precautions below.

An outdoor antenna system should not be located in the vicinity of overhead power lines or other electric light or power circuits, or where it can come in contact with such power lines or circuits. **WHEN INSTALLING AN OUTDOOR ANTENNA SYSTEM, EXTREME CARE SHOULD BE TAKEN TO KEEP FROM CONTACTING SUCH POWER LINES OR CIRCUITS AS CONTACT WITH THEM IS ALMOST INVARIABLY FATAL.**

Be sure the antenna system is grounded so as to provide some protection against voltage surges and built-up static charges. Section 810 of the National Electrical Code provides information with respect to proper grounding of the mast and supporting structure, Grounding of the lead-in wire to an antenna discharge unit, size of grounding conductors, location of antenna-discharge unit, connection to grounding electrodes, and requirements for the grounding electrode.

Antenna Grounding According to the National Electrical Code

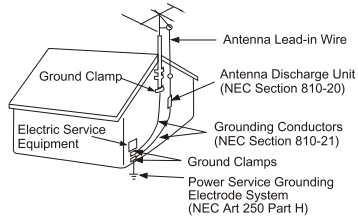

NEC-NATIONAL ELECTRICAL CODE

SERVICE

Damage Requiring Service- Unplug the appliance from the wall outlet and refer servicing to qualified service personnel under the following conditions:

- When the power cord or plug is damaged or frayed.



- If liquid has been spilled or objects have fallen into the appliance.



- If the appliance has been exposed to rain or water.



- The appliance does not appear to operate normally or exhibits a marked change in performance. - This indicates a need for service.



- If the appliance does not operate normally when following the operating instructions, adjust only those controls that are specified in the operating instructions. Improper adjustment of other controls may result in damage and will often require extensive work by a qualified technician to restore the normal operation.



- If the appliance has been subject to excessive shock by being dropped, or the cabinet has been damaged.



Service - Do not attempt to service the appliance yourself as opening or removing covers may expose you to dangerous voltage or other hazards. Refer all servicing to qualified service personnel



Replacement parts- When replacement parts are required, be sure the service technician has used replacement parts specified that have the same characteristics as the original parts. Unauthorized substitutions may result in fire, electric shock, or other hazards.

Safety Check - Upon completion of any service or repairs to the appliance, ask the service technician to perform routine safety checks (as specified) to determine that the appliance is in safe operating condition.



1. Do not install this equipment in a confined or built-in space such as a book case or similar unit, and remain a well ventilation conditions. The ventilation should not be impeded by covering the ventilation openings with items such as newspaper, table-cloths, curtains etc. Minimum 10 cm distance around the apparatus for sufficient ventilation.
2. **WARNING** : To reduce the risk of fire or electric shock, do not expose this apparatus to rain or moisture. The apparatus shall not be exposed to dripping or splashing and that objects filled with liquids, such as vases, shall not be placed on apparatus.
3. **WARNING**: The batteries shall not be exposed to excessive heat such as sunshine, fire or the like.
4. **WARNING**: The mains plug is used as disconnect device, the disconnect device shall remain readily operable.
5. Invisible laser radiation when open and interlocks defeated. Avoid exposure to beam of laser.
6. **Correct Disposal of this product.** This marking indicates that this product should not be disposed with other household wastes throughout the EU. To prevent possible harm to the environment or human health from uncontrolled waste disposal, recycle it responsibly to promote the sustainable reuse of material resources. To return your used device, please use the return and collection systems or contact the retailer where the product was purchased. They can take this product for environmental safe recycling.



ATTENTION: this symbol indicates that this appliance is a class 1 laser product.

- Do not try to open the cover or look at the laser beam.
- Never touch the laser lens inside the compartment.

FRONT AND REAR PANEL

FRONT PANEL

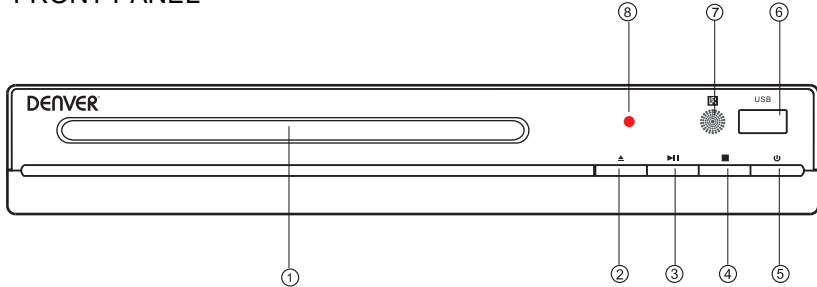

- ① CD DOOR
- ② OPEN/CLOSE
- ③ PLAY/PAUSE
- ④ STOP
- ⑤ STANDBY
- ⑥ USB
- ⑦ REMOTE CONTROL SENSOR
- ⑧ POWER LED INDICATOR

REAR PANEL

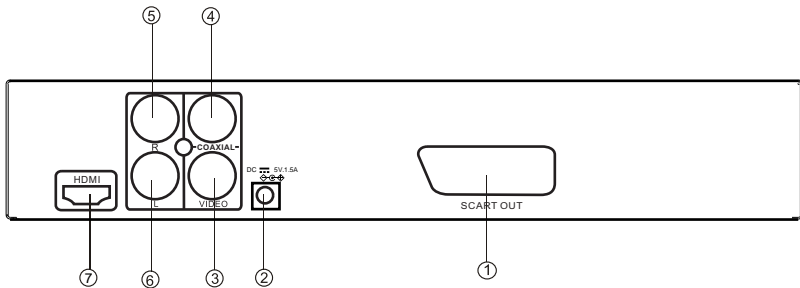

- ① Scart output jack
- ② DC IN jack
- ③ VIDEO output jack
- ④ Digital signal COAXIAL output jack
- ⑤ RIGHT output jack
- ⑥ LEFT output jack
- ⑦ HDMI output jack

REMOTE CONTROL

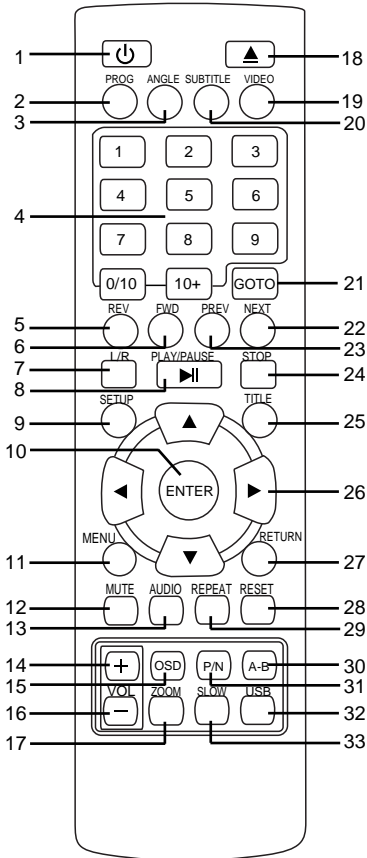

1. Power Button
2. PROG(program) Button
3. ANGLE Button
4. Numeric Buttons
5. REV(reverse) Button
6. FWD(forward) Button
7. L/R Button
8. PLAY/PAUSE Button
9. SETUP Button
10. ENTER Button
11. MENU Button
12. MUTE Button
13. AUDIO Button
14. + (volume up) Button
15. OSD(on screen display) Button
16. - (volume down) Button
17. ZOOM Button
18. Open/Close Button
19. VIDEO Button
20. SUBTITLE Button
21. GOTO Button
22. NEXT Button
23. PREV(previous)Button
24. STOP Button
25. TITLE Button
26. Navigation Buttons
27. RETURN Button
28. RESET Button
29. REPEAT Button
30. A-B Button
31. P/N(PAL/NTSC) Button
32. USB Button
33. SLOW Button

REMOTE CONTROL OPERATION



Press to power on the unit from standby mode, press again to turn to standby mode.

ANGLE

During playback a DVD disc with multi-angle recording, press repeatedly to select the viewing angle. (It depends on the recording of disc).

SUBTITLE

During DVD playback, press repeatedly to select the desired subtitle (It depends on recording of disc).

VIDEO

Press to switch video mode.

GOTO

DVD:

During DVD playback, press the GOTO Button once, the Title, Chapter and Time selection menu will appear on screen. Use the Direction and Numeric Buttons to select the desired title, chapter and time, then press the ENTER Button to start playback.

CD:

During CD playback, press the GOTO Button once, the Track and Time selection menu will appear on screen. Use the Direction and Numeric Buttons to select the desired track and time, then press the ENTER Button to start playback.

L/R

Press to change to Mono L, Mono R, Mix Mono or Stereo(It depends on disc type).

SETUP

Press to enter setup menu, using navigation and ENTER button to set to desired setting. Press the setup button to exit setup menu.

NOTE: The parental passcode is "8888".

TITLE

Press to return to disc's title page (Function depends on the recording of the disc).

MENU

Press to return to disc's menu page (Function depends on the recording of the disc).

REMOTE CONTROL OPERATION

RETURN

Press to return to previous menu. (It depends on the recording of the disc).

MUTE

Press to turn off the sound, press again to resume.

AUDIO

During playback, press repeatedly to select the desired audio mode.
(Function depends on the recording of disc).

RESET

Press to reset to default settings.

VOL +/-

Press to adjust volume level.

OSD (On Screen Display)

During playback, press repeatedly to display playing status or turn it off.

P/N (PAL/NTSC)

Press repeatedly to select and set the color system to NTSC, PAL or AUTO to match the color system of the connected TV.

A-B

During playback, press the A-B Button to define the starting point, press again to define the ending point, the unit will then play the selected section repeatedly. To cancel, press the A-B Button again. (This function is not available on all discs).

ZOOM

During movies playback, press repeatedly to zoom in or zoom out the picture.
(It depends on the recording of the disc).

SLOW

During playback, press the SLOW Button repeatedly to set slow motion speed. Press ►|| (Play/Pause) Button to resume normal playback.

USB

Press to enter DISC/USB mode selection window, using direction and ENTER button on to select and set to desired mode.

REMOTE CONTROL OPERATION

Repeat Playing: (DVD)

- ~ Press the REPEAT button to "Repeat Chapter", the current chapter will be played repeatedly.
- ~ Press the REPEAT button again to "Repeat Title", the title will be played repeatedly.
- ~ Press the REPEAT button the third time to "Repeat All", all files will be played repeatedly.
- ~ Press the REPEAT button the fourth time to "Repeat Off", repeat will be cancelled.

Repeat Playing: (CD)

- ~ Press the REPEAT button to "Repeat 1", the current track will be played repeatedly.
- ~ Press the REPEAT button again to "Repeat All", all tracks will be played repeatedly.
- ~ Press the REPEAT button the third time to "Repeat Off", repeat will be cancelled.

(CD/DVD)Program:

1. During DVD or CD playback, press the PROG Button on remote control, the program setting menu will appear as below:

DVD:

T	C	T	C	T	C	T	C
1 -- :-	5 -- :-	9 -- :-	13 -- :-				
2 -- :-	6 -- :-	10 -- :-	14 -- :-				
3 -- :-	7 -- :-	11 -- :-	15 -- :-				
4 -- :-	8 -- :-	12 -- :-	16 -- :-				

PLAY CLEAR

CD:

1 ---	5 ---	9 ---	13 ---		
2 ---	6 ---	10 ---	14 ---		
3 ---	7 ---	11 ---	15 ---		
4 ---	8 ---	12 ---	16 ---		

PLAY CLEAR

2. Using the direction and numeric buttons to set the desired Title, Chapter or Tracks.
3. For wrong setting, highlight the CLEAR Button on screen, then press the ENTER button to clear all settings.
4. After programming, using the direction buttons to highlight the PLAY Button on the screen, press the ENTER button to start program playing.

REMOTE CONTROL OPERATION

USB function

USB

Choose this button to setup DISC,USB mode

DISC only:

If you are only playing DISC (but no USB),after you put disc into the tray , the appliance will play the DISC automatically.

USB only:

If you are only playing USB (but no Disc),after you insert the USB into the USB port,the appliance will play the USB automatically.

DISC/USB both:

If you put the disc in the tray and in the meantime insert the USB into the USB port, the appliance will play the DISC in priority .

If you want to switch to playing the USB, please press the USB button to pop up the DISC/USB mode selection window, using navigation button to select USB, press ENTER to confirm, the appliance then recognize and read the USB.

If you want to switch to playing the Disc from USB, please press the USB button to pop up the DISC/USB mode selection window, using navigation button to select DISC, press ENTER to confirm, the appliance will turn back to disc reading.

CONNECTION

HDMI

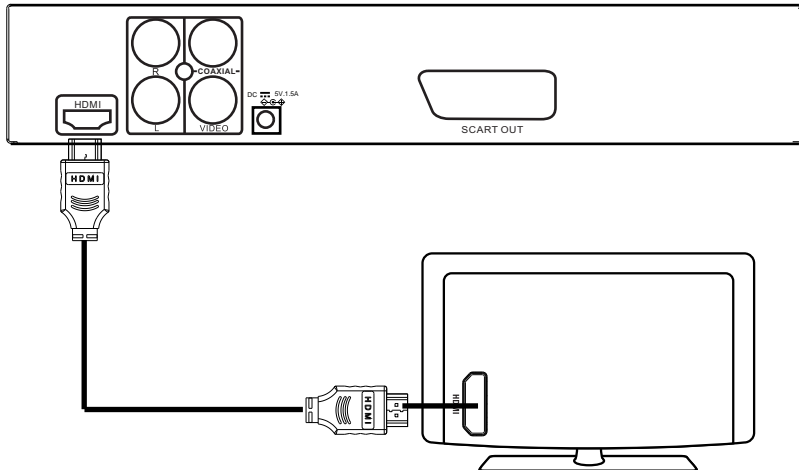

CONNECTION

SCART

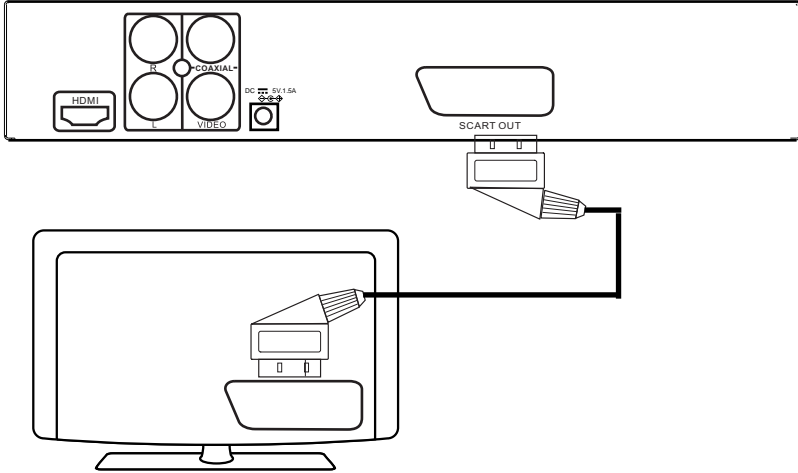

A/V

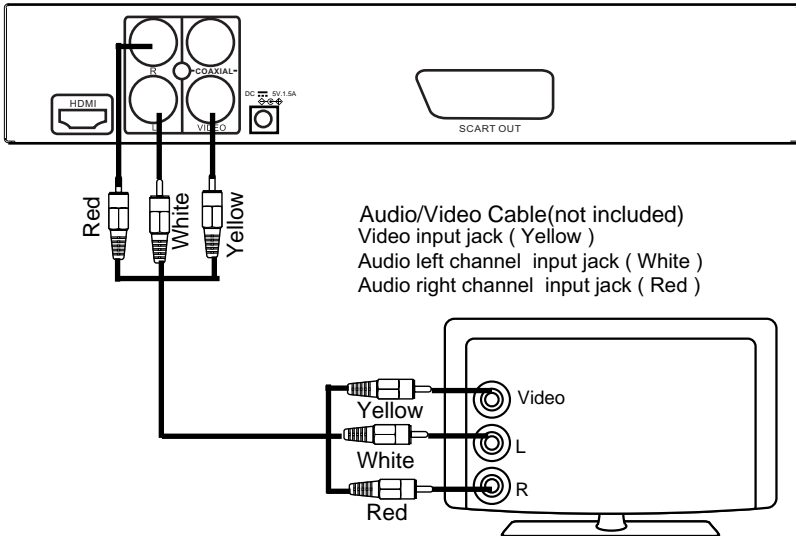

CONNECTION

COAXIAL

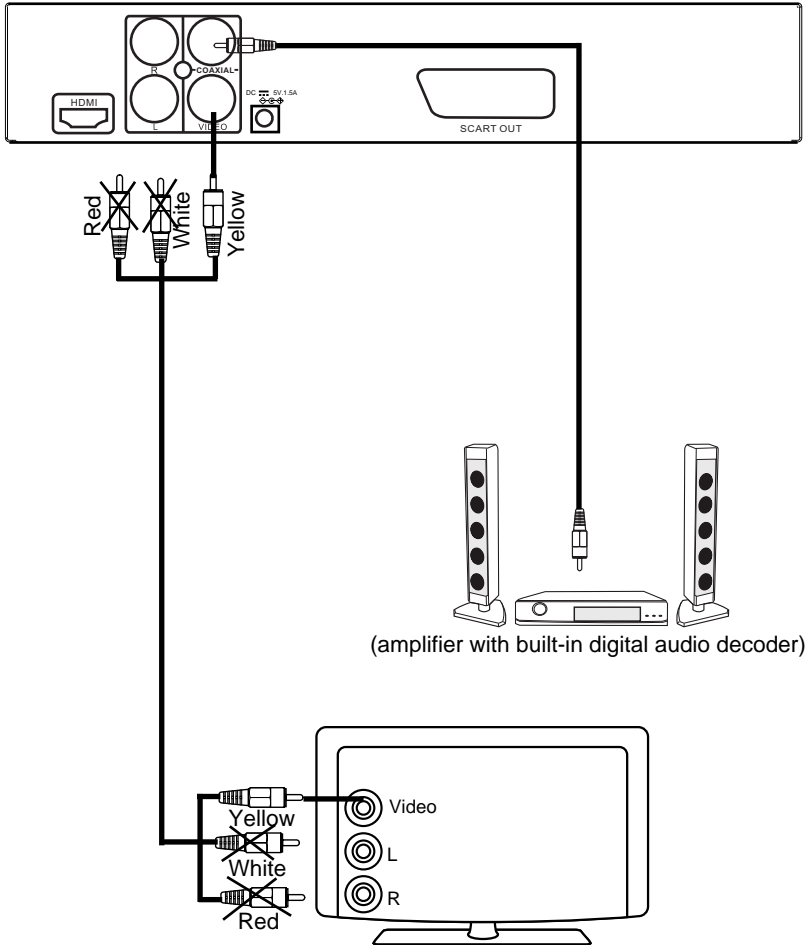

TROUBLESHOOTING

REMOTE CONTROL IS INSENSITIVE OR DOES NOT WORK

Check the batteries of remote control and make sure that they are to be powerful and good conductivity.
 Direct the remote control to the IR sensor of the player.
 Check whether there are some obstacles between the remote control and IR sensor.

ABNORMAL FUNCTION OPERATION

Turn off the power, and then turn on again.

DISC IS LOCKED IN THE TRAY

The disc can not be taken out of the tray when the player is reading, so you have to turn off the power and turn on again, press OPEN/CLOSE key immediately to open the tray.

Type of Disc	DVD/VC/D/HD/CD/DVD±R/RW /AVI,WMA,MP3 Kodak Picture CD	Frequency Response	CD: 4Hz 20KHz (EIAT)
			DVD: 4Hz 22KHz (48K) 4Hz 44KHz (96K)
Video Format	AVI	S/N ratio	> 90 dB
		THD	< 0.04%
Audio Format	MPEG 1, LAYER 1, LAYER 2, LAYER 3	Output Terminals	HDMI output X1 Video output X 1 2,0ch output X 1 Coaxial output X 1 Scart output X 1
Signal Output	Color System: PAL/NTSC/MULTI Audio System: AC-3 Digital output Audio DAC: 16bit/48KHz Video Output: 1 Vpp (at 75 ohm) Audio Output: 2 Vpp		Power input
		Dimensions	Body size : L225*W191*H45mm Net weight : 0.728 Kg

Please notice - All products are subject to change without any notice.
 We take reservations for errors and omissions in the manual.

ALL RIGHTS RESERVED, COPYRIGHT DENVER
 ELECTRONICS A/S

DENVER®

www.denver-electronics.com



DENVER ELECTRONICS A/S
 Omega 5A, Soeften
 DK-8382 Hinnerup
 Denmark

www.facebook.com/denverelectronics

Electric and electronic equipment and included batteries contains materials, components and substances that can be hazardous to your health and the environment, if the waste material (discarded electric and electronic equipment and batteries) is not handled correctly.

Electric and electronic equipment and batteries is marked with the crossed out trash can symbol, seen below. This symbol signifies that electric and electronic equipment and batteries should not be disposed of with other household waste, but should be disposed of separately.

As the end user it is important that you submit your used batteries to the appropriate and designated facility. In this manner you make sure that the batteries are recycled in accordance with legislature and will not harm the environment.

All cities have established collection points, where electric and electronic equipment and batteries can either be submitted free of charge at recycling stations and other collection sites, or be collected from the households. Additional information is available at the technical department of your city.