

LADEKAST IBIS

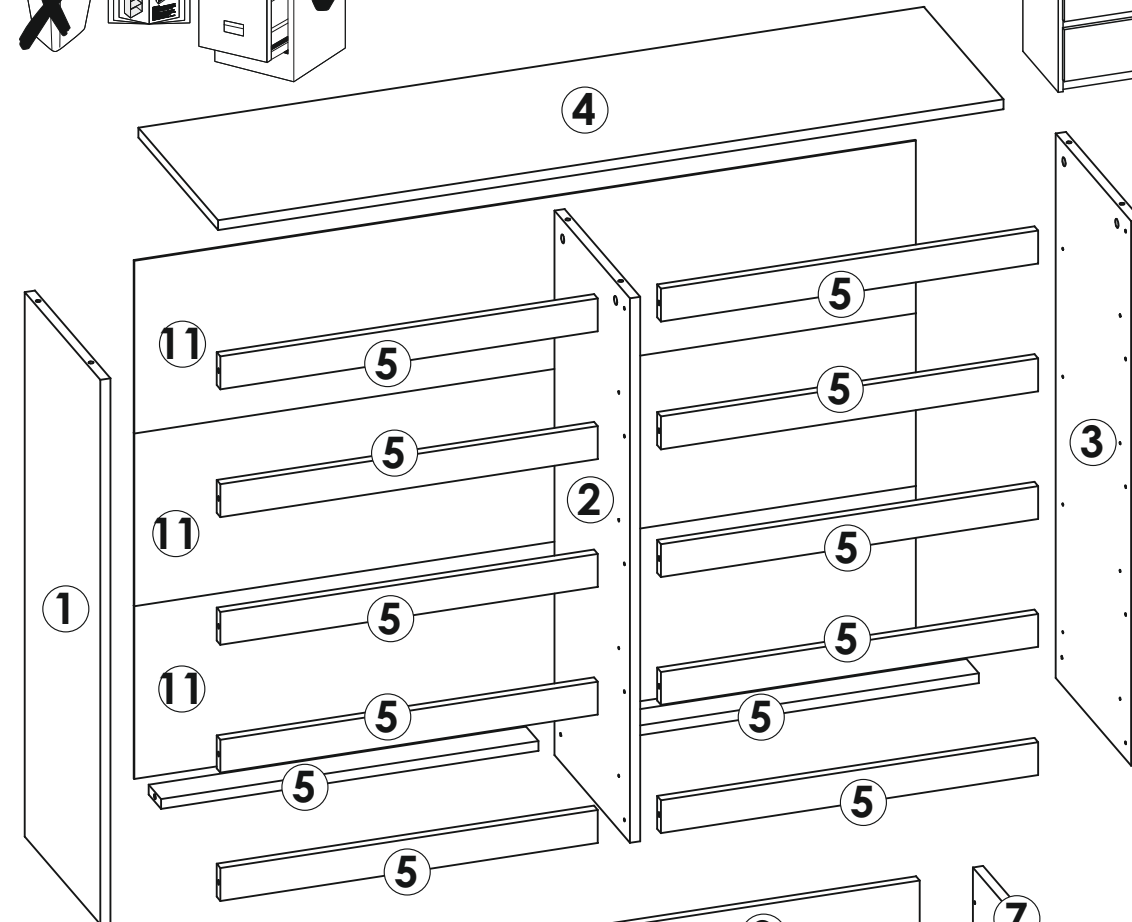

120 8S

1	993	365	x1
2	993	365	x1
3	993	365	x1
4	1200	385	x1
5	573	60	x12
6	350	120	x8
7	350	120	x8
8	513	120	x8
9	586	202	x8
10	547	357	x8
11	1193	315	x3

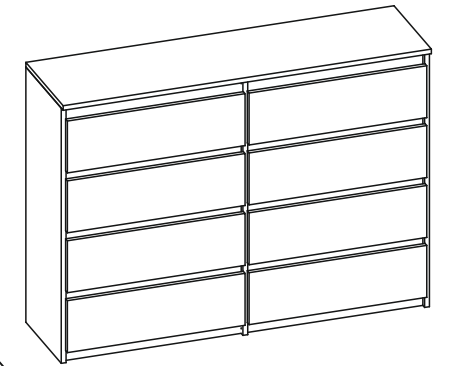
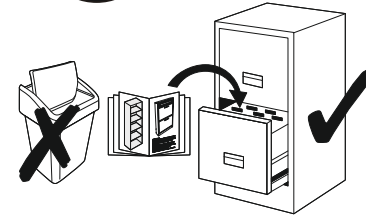
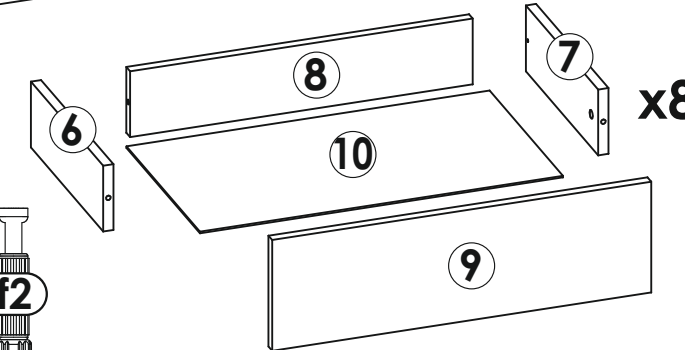
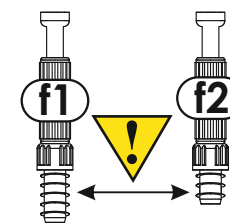
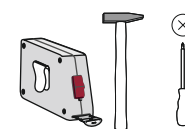
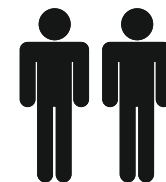

e1	f1	f2	n7
x64	x52	x12	x32
c9	w1	t35	n4
x6	~70	x8	x32

138 8S

1	993	365	x1
2	993	365	x1
3	993	365	x1
4	1382	385	x1
5	664	60	x12
6	350	120	x8
7	350	120	x8
8	603	120	x8
9	677	202	x8
10	637	357	x8
11	1375	315	x3

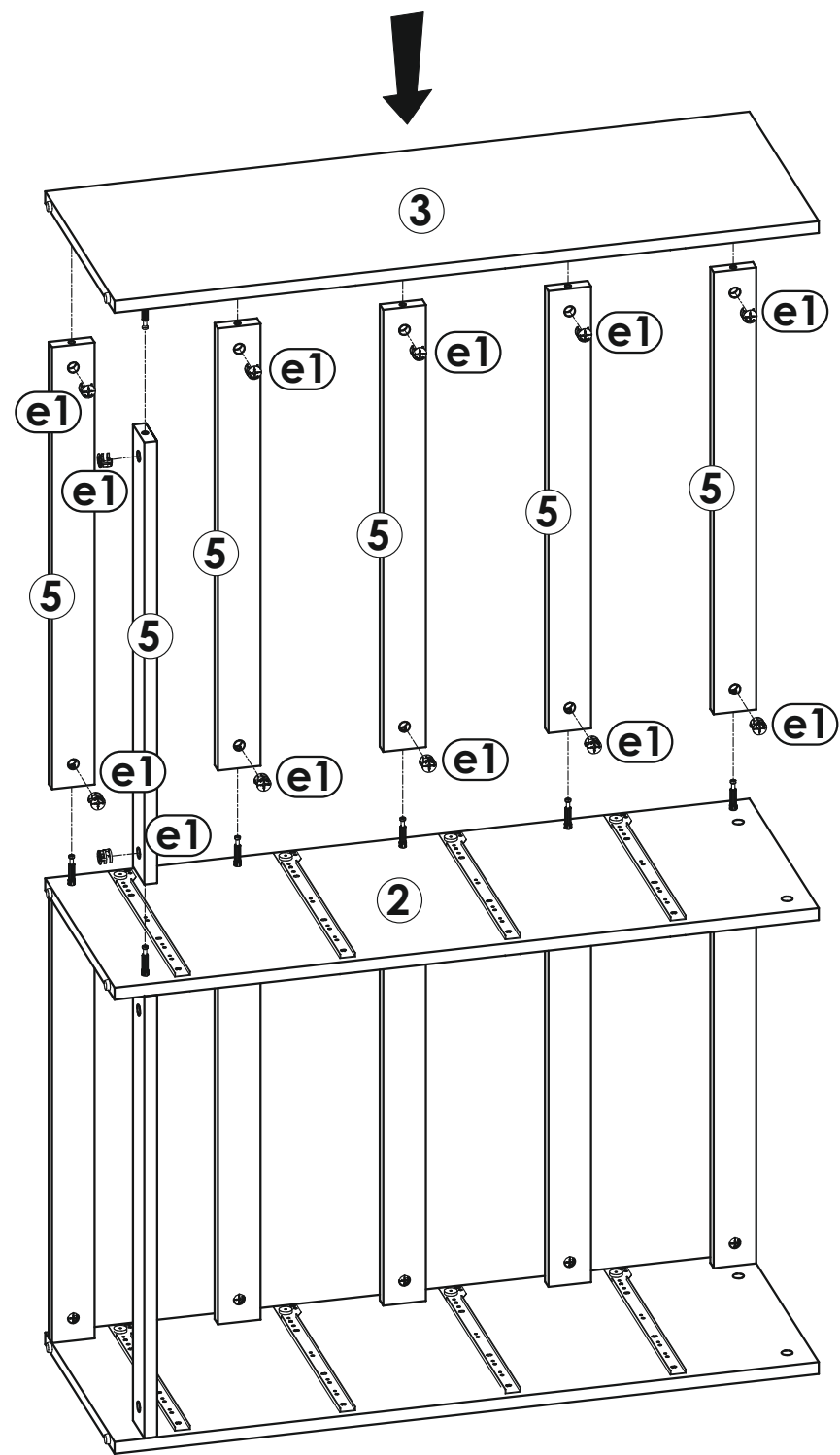
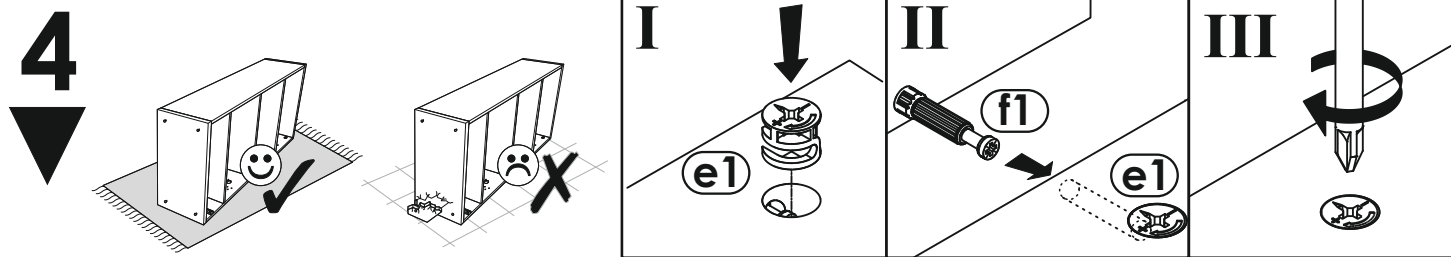

5

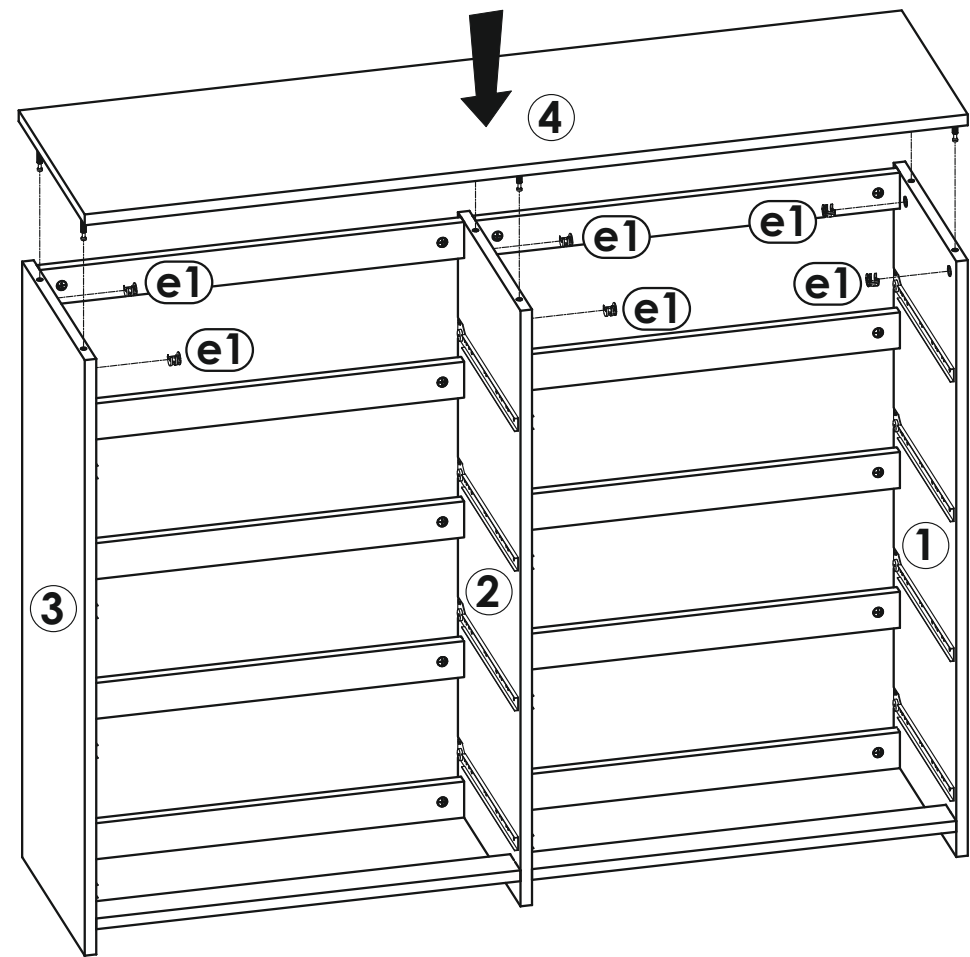

6

$c=d$

