

TEST REPORT

CERTIFICATE OF CONFORMITY

Standard: EN 55032: 2015+A11:2020, Class B
EN 61000-3-2:2014, Class D
EN IEC 61000-3-2:2019 +A1:2021, Class D
EN 61000-3-3:2013 +A1:2019 +A2:2021
EN 55035:2017 +A11:2020

Report No.: CEBEFM-WTW-P23010039

Product: LCD Monitor

Brand: ASUS

Model No.: XG49W

Series Model: XG49W***** (The "*" in the model name can be 0 to 9, A to Z, a to z, +, -, /, \, or blank, for marketing purpose only.)

Received Date: 2023/1/3

Test Date: 2023/1/4 ~ 2023/1/12

Issued Date: 2023/2/2

Applicant: TOP VICTORY ELECTRONICS (TAIWAN) CO., LTD.

Address: 10F., No 230, Liancheng Rd., Zhonghe Dist., New Taipei City 23553, Taiwan

Issued By: Bureau Veritas Consumer Products Services (H.K.) Ltd., Taoyuan Branch
Lin Kou Laboratories

Lab Address: No. 47-2, 14th Ling, Chia Pau Vil., Lin Kou Dist., New Taipei City, Taiwan

Test Location: No. 47-2, 14th Ling, Chia Pau Vil., Lin Kou Dist., New Taipei City, Taiwan

Approved by:



Date:

2023/2/2

Jim Hsiang / Associate Technical Manager

This test report consists of 92 pages in total. It may be duplicated completely for legal use with the approval of the applicant. It should not be reproduced except in full, without the written approval of our laboratory. The test results in the report only apply to the tested sample. The test results in this report are traceable to the national or international standards.



Prepared by : Albee Chu / Senior Specialist

Table of Contents

Release Control Record	4
1 Certificate	5
2 Summary of Test Results	6
2.1 Performance Criteria	7
2.2 Measurement Uncertainty	10
2.3 Supplementary Information	10
3 General Information	11
3.1 Description of EUT	11
3.2 Primary Clock Frequencies of Internal Source	11
3.3 Features of EUT	11
3.4 Operating Modes of EUT and Determination of Worst Case Operating Mode	12
3.5 Test Program Used and Operation Descriptions	15
3.6 Connection Diagram of EUT and Peripheral Devices	16
3.7 Configuration of Peripheral Devices and Cable Connections	17
4 Test Instruments	19
4.1 Conducted Emissions from Power Ports	19
4.2 Conducted Emissions from Wired Network Ports	20
4.3 Radiated Emissions up to 1 GHz	21
4.4 Radiated Emissions above 1 GHz	22
4.5 Harmonic Current Measurement	23
4.6 Voltage Fluctuations and Flicker Measurement	23
4.7 Electrostatic Discharges (ESD)	23
4.8 Radio Frequency Electromagnetic Field (RS)	24
4.9 Fast Transients Common Mode (EFT)	25
4.10 Surges	25
4.11 Radio Frequency Common Mode (CS)	26
4.12 Power Frequency Magnetic Field (PFMF)	27
4.13 Voltage Dips and Interruptions (DIP)	27
5 Limits of Test Items	28
5.1 Conducted Emissions from Power Ports	28
5.2 Conducted Emissions from Wired Network Ports	28
5.3 Radiated Emissions up to 1 GHz	28
5.4 Radiated Emissions above 1 GHz	29
5.5 Harmonic Current Measurement	30
5.6 Voltage Fluctuations and Flicker Measurement	31
5.7 General immunity requirements	32
6 Test Arrangements	34
6.1 Conducted Emissions from Power Ports	34
6.2 Conducted Emissions from Wired Network Ports	35
6.3 Radiated Emissions up to 1 GHz	38
6.4 Radiated Emissions above 1 GHz	39
6.5 Harmonic Current Measurement	40
6.6 Voltage Fluctuations and Flicker Measurement	40
6.7 Electrostatic Discharges (ESD)	41
6.8 Radio Frequency Electromagnetic Field (RS)	43
6.9 Fast Transients Common Mode (EFT)	44
6.10 Surges	45
6.11 Radio Frequency Common Mode (CS)	47
6.12 Power Frequency Magnetic Field (PFMF)	49
6.13 Voltage Dips and Interruptions (DIP)	50
7 Test Results of Test Item	51
7.1 Conducted Emissions from Power Ports	51
7.2 Conducted Emissions from Wired Network Ports	59



7.3	Radiated Emissions up to 1 GHz	60
7.4	Radiated Emissions above 1 GHz.....	64
7.5	Harmonic Current Measurement.....	68
7.6	Voltage Fluctuations and Flicker Measurement	69
7.7	Electrostatic Discharges (ESD).....	70
7.8	Radio Frequency Electromagnetic Field (RS).....	75
7.9	Fast Transients Common Mode (EFT).....	75
7.10	Surges	76
7.11	Radio Frequency Common Mode (CS).....	76
7.12	Power Frequency Magnetic Field (PFMF).....	77
7.13	Voltage Dips and Interruptions (DIP).....	77
8	Pictures of Test Arrangements	78
8.1	Conducted Emissions from Power Ports.....	78
8.2	Conducted Emissions from Wired Network Ports	80
8.3	Radiated Emissions up to 1 GHz	81
8.4	Radiated Emissions above 1 GHz.....	83
8.5	Harmonic Current Measurement.....	85
8.6	Voltage Fluctuations and Flicker Measurement	85
8.7	Electrostatic Discharges (ESD).....	86
8.8	Radio Frequency Electromagnetic Field (RS).....	87
8.9	Fast Transients Common Mode (EFT).....	88
8.10	Surges	89
8.11	Radio Frequency Common Mode (CS).....	90
8.12	Power Frequency Magnetic Field (PFMF).....	91
8.13	Voltage Dips and Interruptions (DIP).....	91
9	Information of the Testing Laboratories	92



Release Control Record

Issue No.	Description	Date Issued
CEBEFM-WTW-P23010039	Original release.	2023/2/2

1 Certificate

Product: LCD Monitor

Brand: ASUS

Model No.: XG49W

Series Model: XG49W***** (The "*" in the model name can be 0 to 9, A to Z, a to z, +, -, /, \, or blank, for marketing purpose only.)

Sample Status: Engineering sample

Applicant: TOP VICTORY ELECTRONICS (TAIWAN) CO., LTD.

Test Date: 2023/1/4 ~ 2023/1/12

Standard: EN 55032: 2015+A11:2020, Class B
EN 61000-3-2:2014, Class D
EN IEC 61000-3-2:2019 +A1:2021, Class D
EN 61000-3-3:2013 +A1:2019 +A2:2021
EN 55035:2017 +A11:2020

Measurement procedure: EN 61000-4-2:2009 / IEC 61000-4-2:2008 ED. 2.0
EN IEC 61000-4-3: 2020 / IEC 61000-4-3: 2020 ED. 4.0
EN 61000-4-4: 2012 / IEC 61000-4-4: 2012 ED. 3.0
EN 61000-4-5: 2014+A1:2017 / IEC 61000-4-5: 2017 ED. 3.1
EN 61000-4-6: 2014+AC:2015 / IEC 61000-4-6: 2013 ED. 4.0
EN 61000-4-8: 2010 / IEC 61000-4-8: 2009 ED. 2.0
EN IEC 61000-4-11: 2020+AC:2020 / IEC 61000-4-11: 2020 ED. 3.0

The above equipment has been tested by **Bureau Veritas Consumer Products Services (H.K.) Ltd., Taoyuan Branch**, and found compliance with the requirement of the above standards. The test record, data evaluation & Equipment Under Test (EUT) configurations represented herein are true and accurate accounts of the measurements of the sample's EMC characteristics under the conditions specified in this report.

2 Summary of Test Results

The test items that the EUT need to perform in accordance with its interfaces, evaluated functions are as follows:

Standard	Test Item	Result	Remark
EN 55032	Conducted Emissions from Power Ports	Pass	Minimum passing Class B margin is -6.37 dB at 0.30606 MHz
EN 55032	Conducted Emissions from Wired Network Ports	Pass	Minimum passing Class B margin is -14.38 dB at 28.02396 MHz
EN 55032	Radiated Emissions up to 1 GHz	Pass	Minimum passing Class B margin is -4.17 dB at 684.78 MHz
EN 55032	Radiated Emissions above 1 GHz	Pass	Minimum passing Class B margin is -13.24 dB at 2796.00 MHz
EN 61000-3-2	Harmonic Current Measurement	Pass	Meets Class D Limit
EN 61000-3-3	Voltage Fluctuations and Flicker Measurement	Pass	$P_{st} \leq 1.00$ $d_{max} \leq 4.00\%$ $P_{lt} \leq 0.65$ $d_c \leq 3.30\%$ $T_{max} \leq 500$ ms
IEC 61000-4-2	Electrostatic Discharges (ESD)	Pass	For EN 55035 Performance Criteria B
IEC 61000-4-3	Radio Frequency Electromagnetic Field (RS)	Pass	For EN 55035 Performance Criteria A
IEC 61000-4-4	Fast Transients Common Mode (EFT)	Pass	For EN 55035 Performance Criteria A
IEC 61000-4-5	Surges	Pass	For EN 55035 Performance Criteria A
IEC 61000-4-6	Radio Frequency Common Mode (CS)	Pass	For EN 55035 Performance Criteria A
IEC 61000-4-8	Power Frequency Magnetic Field (PFMF)	Pass	For EN 55035 Performance Criteria A
IEC 61000-4-11	Voltage Dips and Interruptions (DIP)	Pass	For EN 55035 For Voltage Dips: < 5% Residual, 0.5 cycle Performance Criteria A 70% Residual, 25 cycle Performance Criteria A For Voltage Interruptions: < 5% Residual, 250 cycle Performance Criteria C

Note: Determining compliance based on the results of the compliance measurement, not taking into account measurement instrumentation uncertainty.

2.1 Performance Criteria

General Performance Criteria

These criteria shall be used during the testing of primary functions where no specified in the normative annexes of EN 55035 is applicable.

Performance criterion A

The equipment shall continue to operate as intended without operator intervention. No degradation of performance, loss of function or change of operating state is allowed below a performance level specified by the manufacturer when the equipment is used as intended. The performance level may be replaced by a permissible loss of performance. If the minimum performance level or the permissible performance loss is not specified by the manufacturer, then either of these may be derived from the product description and documentation, and by what the user may reasonably expect from the equipment if used as intended.

Performance criterion B

During the application of the disturbance, degradation of performance is allowed. However, no unintended change of actual operating state or stored data is allowed to persist after the test.

After the test, the equipment shall continue to operate as intended without operator intervention; no degradation of performance or loss of function is allowed, below a performance level specified by the manufacturer, when the equipment is used as intended. The performance level may be replaced by a permissible loss of performance.

If the minimum performance level (or the permissible performance loss), or recovery time, is not specified by the manufacturer, then either of these may be derived from the product description and documentation, and by what the user may reasonably expect from the equipment if used as intended.

Performance criterion C

Loss of function is allowed, provided the function is self-recoverable, or can be restored by the operation of the controls by the user in accordance with the manufacturer's instructions. A reboot or re-start operation is allowed.

Information stored in non-volatile memory, or protected by a battery backup, shall not be lost.

Product Specific Performance criteria for network functions

Equipment that provides these functions transmits and receives data through ports such as an analogue/digital data port. The networking functions are just like network switching and routing ; data transmission ; supervisory...etc.

The particular performance criteria which are specified in the normative annexes of CISPR 35/ EN 55035 take precedence over the corresponding parts of the general performance criteria.

Performance criterion A

Where relevant, during the application of the test the network function shall, as a minimum, operate ensuring that:

- established connections shall be maintained throughout the application of the test;
- no change of operational state or corruption of stored data occurs;
- no increase in error rate above the figure defined by the manufacturer occurs. The manufacturer should select the most appropriate performance measurement criteria for the product or system, for example bit error rate, block error rate;
- no request for retry above the figure defined by the manufacturer;
- the data transmission rate does not reduce below the figure defined by the manufacturer;
- no protocol failure occurs;
- other verifications are described in F.3.3.1 of CISPR 35/ EN 55035.

Performance criterion B

Established connections shall be maintained throughout the test, or shall self-recover in a way and timescale that is imperceptible to the user.

The error rate, request for retry and data transmission rates may be degraded during the application of the test. Degradation of the performance as described in criterion A is permitted, provided that the normal operation of the EUT is self-recoverable to the condition established prior to the application of the test.

Where required, as defined in Clause 5 of CISPR 35/ EN 55035, the acceptable operation of the function shall be verified at the completion of the test as described in Table H.1 of CISPR 35/ EN 55035, by confirming the following:

- the EUT's ability to establish a connection,
- the EUT's ability to clear a connection.

During surge testing disconnection is allowed on the analogue/digital data port being tested.

If the EUT is a supervisory equipment, it shall not impact the normal operation of the network being monitored. In addition, any supervisory functions impacted during the period of the test shall return to the state prior to the test. Elements to consider include: alarms, signalling lamps, printer output, network traffic rates, network monitoring.

Performance criterion C

Degradation of performance as described in criteria A and B is permitted provided that the normal operation of the EUT is self-recoverable to the condition immediately before the application of the test, or can be restored after the test by the operator.

Product Specific Performance Criteria for xDSL

The particular performance criteria which are specified in the normative annexes of CISPR 35/ EN 55035 take precedence over the corresponding parts of the general performance criteria.

Performance criterion A

Applicable for the test requirement defined in table clause 2.1 of EN 55035

During the swept frequency test the established connection shall be maintained throughout the testing and the information transferred without any additional reproducible errors or loss of synchronisation. If a degradation in performance is observed and the system is adaptive, for example has the capability to automatically retrain in the presence of an interfering signal, then for conducted immunity tests only, the following procedure shall be followed:

- a) For each range of interfering frequencies in which degradation in performance is observed, three frequencies (beginning, middle and end) shall be identified.
- b) At each of the frequencies identified in step a), the interfering signal shall be turned on and the system is allowed to retrain.
- c) If the system is able to retrain and then functions correctly for a dwell time of at least 60 seconds without any additional reproducible errors or loss of synchronisation, then the performance level of the system is considered acceptable.
- d) The frequencies identified in step a) and the data rates achieved in step b) shall be recorded in the test report.

Applicable for the test requirement defined in table clause 2.2 of EN 55035

It is important that the modems are able to train in the presence of repetitive impulsive noise and minimize disruption to the end-user where a repetitive impulsive noise source starts after the link has synchronized. Therefore the following procedure and performance criteria shall apply.

The manufacturer shall select the class of impulsive noise protection (INP) to be used for the immunity test and should state this information in the technical documentation and in the test report. The maximum delay shall be set to 8 ms.

In the absence of impulsive noise: The modem shall operate without retraining at its target noise margin with a bit rate value depending on the line attenuation and the stationary noise being present on the line. (The actual value will be between the minimum and maximum bit rate values programmed in the port).

The impulsive noise source shall then be applied at the required test level.

With the impulsive noise applied: The modem shall operate without retraining and without SES at the bit rate established prior to the application of the impulsive noise. No extra CRC errors shall occur due to the impulsive noise. After the test, the noise margin value shall return to the target noise margin.

Performance criterion B

Applicable for the test requirement defined in table clause 2.3 of EN 55035

Modems shall withstand the occurrence of isolated impulsive noise events. The performance criteria defined in below Table shall be applied.

Impulse duration (ms)	Performance criteria
0.24	The application of the impulse shall not cause the xDSL link to lose synchronisation. No CRC errors are permitted.
10	The application of the 5 impulses shall result in less than 75 CRC errors and shall not cause the link to lose synchronisation.
300	The application of the impulse shall not cause the xDSL link to lose synchronisation.

Applicable for the test requirements defined in table clauses 2.5 and 4.5 of EN 55035

For application of this test to the xDSL port, a repetition rate of 100 kHz (burst length 0.75 ms) shall be used.

Degradation of the performance as described in criterion A is permitted in that errors are acceptable during the application of the test. However the application of the test shall not cause the system to lose the established connection or re-train. At the cessation of the test the system shall operate in the condition established prior to the application of the test without user intervention.

After the application of the EFT/B tests to the xDSL or AC mains port, the CRC error count shall not have increased by more than 600 when compared to the count prior to the application of the test.

Performance criterion C

Degradation of the performance as described in criteria A and B is permitted provided that the normal operation of the EUT is self-recoverable to the condition established prior to application of the test or can be restored after the test by the operator.

2.2 Measurement Uncertainty

Where relevant, the following measurement uncertainty levels have been estimated for tests performed on the EUT as specified in CISPR 16-4-2:

Measurement	Specification	Expanded Uncertainty (k=2) (±)	Maximum allowable uncertainty (±)
Conducted Emissions from Power Ports	9 kHz ~ 30 MHz	3.00 dB	3.4 dB (U_{CISPR})
Conducted Emissions from Wired Network Ports	150 kHz ~ 30 MHz	ISN Cat3 : 3.48 dB ISN Cat5 : 3.94 dB ISN Cat6 : 4.44 dB Current Probe : 1.94 dB Voltage Probe : 3.02 dB Coaxial : 2.48 dB	5.0 dB (U_{CISPR}) using AAN 2.9 dB (U_{CISPR}) using CP 3.9 dB (U_{CISPR}) using CVP
Radiated Emissions up to 1 GHz	30 MHz ~ 1 GHz	3m: 5.44 dB 10m: 4.02 dB	6.3 dB (U_{CISPR})
Radiated Emissions above 1 GHz	1 GHz ~ 6 GHz	4.94 dB	5.2 dB (U_{CISPR})

The other instruments specified are routine verified to remain within the calibrated levels, no measurement uncertainty is required to be calculated.

2.3 Supplementary Information

There is not any deviation from the test standards for the test method, and no modifications required for compliance.

3 General Information

3.1 Description of EUT

Product	LCD Monitor
Brand	ASUS
Test Model	XG49W
Series Model	XG49W***** (The "*" in the model name can be 0 to 9, A to Z, a to z, +, -, /, \, or blank, for marketing purpose only.)
Model Difference	For marketing purpose
Sample Status	Engineering sample
Operating Software	N/A
Power Supply Rating	Internal switching power supply Rating: 100-240Vac, 50/60Hz Power Cord: Non-shielded AC cable (1.8m)
Accessory Device	N/A
Data Cable Supplied	Shielded HDMI cable (1.8m) Shielded Display cable (1.8m) Shielded USB-C cable (1.5m) Shielded USB 3.0 cable (1.8m)

Note:

The EUT is a LCD Monitor and it has the following models and interfaces:

Model	Interfaces	Differentiation
XG49W XG49WCR, XG49WCRY, XG49WCRZ, XG49WCR-P, XG49WCR-J, XG49WCR-R, XG49WCR-E, XG49WCR-W, XG49WCR-G	<ul style="list-style-type: none"> ◆ HDMI in (up to 5120 x 1440, 75Hz) ◆ Display in (up to 5120 x 1440, 165Hz) ◆ USB-C (up to 5120 x 1440, 165Hz) with PD 90W max. ◆ LAN (10/100/1000Mbps) ◆ USB-A *3 ◆ USB-B ◆ Audio in ◆ AC in 	Marketing purpose

3.2 Primary Clock Frequencies of Internal Source

The highest frequency generated or used within the EUT or on which the EUT operates or tunes is 1329.3MHz, provided by TOP VICTORY ELECTRONICS (TAIWAN) CO., LTD., for detailed internal source, please refer to the manufacturer's specifications.

3.3 Features of EUT

The tests reported herein were performed according to the method specified by TOP VICTORY ELECTRONICS (TAIWAN) CO., LTD., for detailed feature description, please refer to the manufacturer's specifications or user's manual. Please refer to appendix of the report if the applicant has provided additional descriptions of the EUT.

3.4 Operating Modes of EUT and Determination of Worst Case Operating Mode

The EUT has been pre-tested under following test modes.

Test Condition	
Mode	Conducted Emissions from Power Ports
1	DP in (5120*1440/165Hz) + USB-C_PD (w/ 20V/3.25A load) + USB-B to PC + Panel up + Lan ping + w/ earphone
2	DP in (5120*1440/165Hz) + USB-C_PD (w/ 20V/3.25A load) + USB-B to PC + Panel up + Lan ping + w/o earphone
3	DP in (5120*1440/165Hz) + USB-C_PD (w/ 20V/3.25A load) + USB-B to PC + Panel down + Lan ping + w/ earphone
4	DP in (5120*1440/165Hz) + USB-C_PD (w/ 12V/3A load) + USB-B to PC + Panel up + Lan ping + w/ earphone
5	DP in (5120*1440/165Hz) + USB-C_PD (w/ 5V/3A load) + USB-B to PC + Panel up + Lan ping + w/ earphone
6	DP in (5120*1440/165Hz) + USB-C_PD (w/ 20V/3.25A load) + USB-B not connected + Panel up + Lan ping + w/ earphone
7	HDMI in (5120*1440/75Hz) + USB-C_PD (w/ 20V/3.25A load) + USB-B to PC + Panel up + Lan ping + w/ earphone
8	USB-C in (5120*1440/165Hz) + USB-C to PC + USB-B to PC + Panel up + Lan ping + w/ earphone
9	DP in (1920*1080/60Hz) + USB-C_PD (w/ 20V/3.25A load) + USB-B to PC + Panel up + Lan ping + w/ earphone
10	DP in (640*480/60Hz) + USB-C_PD (w/ 20V/3.25A load) + USB-B to PC + Panel up + Lan ping + w/ earphone
11	PBP (DP+HDMI) (5120*1440/165Hz) + USB-C_PD (w/ 20V/3.25A load) + USB-B to PC + Panel up + Lan ping + w/ earphone
12	PIP (DP+HDMI) (5120*1440/165Hz) + USB-C_PD (w/ 20V/3.25A load) + USB-B to PC + Panel up + Lan ping + w/ earphone

Note: The worst case is mode 1.

Mode	Conducted Emissions from Wired Network Ports
1	DP in (5120*1440/165Hz) + USB-C_PD (w/ 20V/3.25A load) + USB-B to PC + Panel up + Lan ping + w/ earphone
2	DP in (5120*1440/165Hz) + USB-C_PD (w/ 20V/3.25A load) + USB-B to PC + Panel up + Lan ping + w/o earphone
3	DP in (5120*1440/165Hz) + USB-C_PD (w/ 20V/3.25A load) + USB-B to PC + Panel down + Lan ping + w/ earphone
4	DP in (5120*1440/165Hz) + USB-C_PD (w/ 12V/3A load) + USB-B to PC + Panel up + Lan ping + w/ earphone
5	DP in (5120*1440/165Hz) + USB-C_PD (w/ 5V/3A load) + USB-B to PC + Panel up + Lan ping + w/ earphone
6	DP in (5120*1440/165Hz) + USB-C_PD (w/ 20V/3.25A load) + USB-B not connected + Panel up + Lan ping + w/ earphone
7	HDMI in (5120*1440/75Hz) + USB-C_PD (w/ 20V/3.25A load) + USB-B to PC + Panel up + Lan ping + w/ earphone
8	USB-C in (5120*1440/165Hz) + USB-C to PC + USB-B to PC + Panel up + Lan ping + w/ earphone
9	DP in (1920*1080/60Hz) + USB-C_PD (w/ 20V/3.25A load) + USB-B to PC + Panel up + Lan ping + w/ earphone
10	DP in (640*480/60Hz) + USB-C_PD (w/ 20V/3.25A load) + USB-B to PC + Panel up + Lan ping + w/ earphone
11	PBP (DP+USB-C) (5120*1440/165Hz) + USB-C_PD (w/ 20V/3.25A load) + USB-B to PC + Panel up + Lan ping + w/ earphone
12	PIP (DP+USB-C) (5120*1440/165Hz) + USB-C_PD (w/ 20V/3.25A load) + USB-B to PC + Panel up + Lan ping + w/ earphone

Note: The worst case is mode 1.

Mode	Radiated Emissions up to 1 GHz
1	DP in (5120*1440/165Hz) + USB-C_PD (w/ 20V/3.25A load) + USB-B to PC + Panel up + Lan ping + w/ earphone
2	DP in (5120*1440/165Hz) + USB-C_PD (w/ 20V/3.25A load) + USB-B to PC + Panel up + Lan ping + w/o earphone
3	DP in (5120*1440/165Hz) + USB-C_PD (w/ 20V/3.25A load) + USB-B to PC + Panel down + Lan ping + w/ earphone
4	DP in (5120*1440/165Hz) + USB-C_PD (w/ 12V/3A load) + USB-B to PC + Panel up + Lan ping + w/ earphone
5	DP in (5120*1440/165Hz) + USB-C_PD (w/ 5V/3A load) + USB-B to PC + Panel up + Lan ping + w/ earphone
6	DP in (5120*1440/165Hz) + USB-C_PD (w/ 20V/3.25A load) + USB-B not connected + Panel up + Lan ping + w/ earphone
7	HDMI in (5120*1440/75Hz) + USB-C_PD (w/ 20V/3.25A load) + USB-B to PC + Panel up + Lan ping + w/ earphone
8	USB-C in (5120*1440/165Hz) + USB-C to PC + USB-B to PC + Panel up + Lan ping + w/ earphone
9	DP in (1920*1080/60Hz) + USB-C_PD (w/ 20V/3.25A load) + USB-B to PC + Panel up + Lan ping + w/ earphone
10	DP in (640*480/60Hz) + USB-C_PD (w/ 20V/3.25A load) + USB-B to PC + Panel up + Lan ping + w/ earphone
11	PBP (DP+USB-C) (5120*1440/165Hz) + USB-C_PD (w/ 20V/3.25A load) + USB-B to PC + Panel up + Lan ping + w/ earphone
12	PIP (DP+USB-C) (5120*1440/165Hz) + USB-C_PD (w/ 20V/3.25A load) + USB-B to PC + Panel up + Lan ping + w/ earphone

Note:

1. There are both standby mode and normal mode to be pre-tested then normal mode has the highest emission value.
2. There are AC 110V/60Hz and AC 230V/50Hz to be pre-tested then (AC 110V/60Hz) has the highest emission value.
3. The worst case is mode 1.

Mode	Radiated Emissions above 1 GHz
1	DP in (5120*1440/165Hz) + USB-C_PD (w/ 20V/3.25A load) + USB-B to PC + Panel up + Lan ping + w/ earphone
2	DP in (5120*1440/165Hz) + USB-C_PD (w/ 20V/3.25A load) + USB-B to PC + Panel up + Lan ping + w/o earphone
3	DP in (5120*1440/165Hz) + USB-C_PD (w/ 20V/3.25A load) + USB-B to PC + Panel down + Lan ping + w/ earphone
4	DP in (5120*1440/165Hz) + USB-C_PD (w/ 12V/3A load) + USB-B to PC + Panel up + Lan ping + w/ earphone
5	DP in (5120*1440/165Hz) + USB-C_PD (w/ 5V/3A load) + USB-B to PC + Panel up + Lan ping + w/ earphone
6	DP in (5120*1440/165Hz) + USB-C_PD (w/ 20V/3.25A load) + USB-B not connected + Panel up + Lan ping + w/ earphone
7	HDMI in (5120*1440/75Hz) + USB-C_PD (w/ 20V/3.25A load) + USB-B to PC + Panel up + Lan ping + w/ earphone
8	USB-C in (5120*1440/165Hz) + USB-C to PC + USB-B to PC + Panel up + Lan ping + w/ earphone
9	DP in (1920*1080/60Hz) + USB-C_PD (w/ 20V/3.25A load) + USB-B to PC + Panel up + Lan ping + w/ earphone
10	DP in (640*480/60Hz) + USB-C_PD (w/ 20V/3.25A load) + USB-B to PC + Panel up + Lan ping + w/ earphone
11	PBP (DP+USB-C) (5120*1440/165Hz) + USB-C_PD (w/ 20V/3.25A load) + USB-B to PC + Panel up + Lan ping + w/ earphone
12	PIP (DP+USB-C) (5120*1440/165Hz) + USB-C_PD (w/ 20V/3.25A load) + USB-B to PC + Panel up + Lan ping + w/ earphone

Note: The worst case is mode 1.

Mode	Harmonic Current Measurement
Note: The EUT was pre-tested under full white screen and ITU-R BT 471-1 color bars signal, and the maximum power was found under (full white screen) for final test.	

Test modes are presented in the report as below.

Test Condition	
Mode	Conducted Emissions from Power Ports
A	DP in (5120*1440/165Hz) + USB-C_PD (w/ 20V/3.25A load) + USB-B to PC + Panel up + Lan ping + w/ earphone + 110V/60Hz
B	DP in (5120*1440/165Hz) + USB-C_PD (w/ 20V/3.25A load) + USB-B to PC + Panel up + Lan ping + w/ earphone + 230V/50Hz
C	HDMI to DVD/2160p + 110V/60Hz
D	HDMI to DVD/2160p + 230V/50Hz
Mode	Conducted Emissions from Wired Network Ports
A	DP in (5120*1440/165Hz) + USB-C_PD (w/ 20V/3.25A load) + USB-B to PC + Panel up + Lan ping (1000Mbps) + w/ earphone + 230V/50Hz
Note: There are both link mode and idle mode to be pre-tested then link mode has the highest emission value.	
Mode	Radiated Emissions up to 1 GHz
A	DP in (5120*1440/165Hz) + USB-C_PD (w/ 20V/3.25A load) + USB-B to PC + Panel up + Lan ping + w/ earphone + 110V/60Hz
B	HDMI to DVD/2160p + 110V/60Hz
Mode	Radiated Emissions above 1 GHz
A	DP in (5120*1440/165Hz) + USB-C_PD (w/ 20V/3.25A load) + USB-B to PC + Panel up + Lan ping + w/ earphone + 110V/60Hz
B	HDMI to DVD/2160p + 110V/60Hz
Mode	Harmonic Current Measurement
A	DP in (5120*1440/165Hz) + USB-C_PD (w/ 20V/3.25A load) + USB-B to PC + Panel up + Lan ping + w/ earphone + 230V/50Hz
B	DP in (5120*1440/165Hz) + USB-C_PD (w/ 20V/3.25A load) + USB-B to PC + Panel up + Lan ping + w/ earphone + 230V/50Hz <Default mode>
Mode	Voltage Fluctuations and Flicker Measurement
A	DP in (5120*1440/165Hz) + USB-C_PD (w/ 20V/3.25A load) + USB-B to PC + Panel up + Lan ping + w/ earphone + 230V/50Hz
Mode	Immunity Tests
A	DP in (5120*1440/165Hz) + USB-C_PD (w/ 20V/3.25A load) + USB-B to PC + Panel up + Lan ping + w/ earphone + 230V/50Hz

3.5 Test Program Used and Operation Descriptions

For Emission test (Harmonics & Flicker excluded)

- a. Turned on the power of all equipment.
- b. PC ran a test program to enable all functions.
- c. PC read and wrote messages from ext. HDDs via EUT.
- d. PC sent and received messages from LAPTOP (kept in a remote area) with UTP cable.
- e. PC/ DVD player sent the "color bar patterns with moving element" signal to EUT, and then displayed on its screen.
- f. PC sent messages to printer and printer printed them out.
- g. PC sent "1kHz" audio message to earphone via EUT.
- h. Steps c-g were repeated.

For Harmonics, Flicker & Immunity tests

- a. Turned on the power of all equipment.
- b. PC ran a test program to enable all functions.
- c. PC read and wrote messages from ext. SSDs via EUT.
- d. PC sent and received messages from LAPTOP (kept in a remote area) with UTP cable.
- e. PC sent full white screen to EUT, and then displayed on its screen. **<For Harmonics & Flicker tests>**
- f. PC sent " color bars with moving element " messages to EUT, and then displayed on its screen. **<For Immunity tests>**
- g. PC sent "1kHz" audio message to speaker via EUT.
- h. Steps c-g were repeated.

3.6 Connection Diagram of EUT and Peripheral Devices

For Emission test (Harmonics & Flicker excluded)

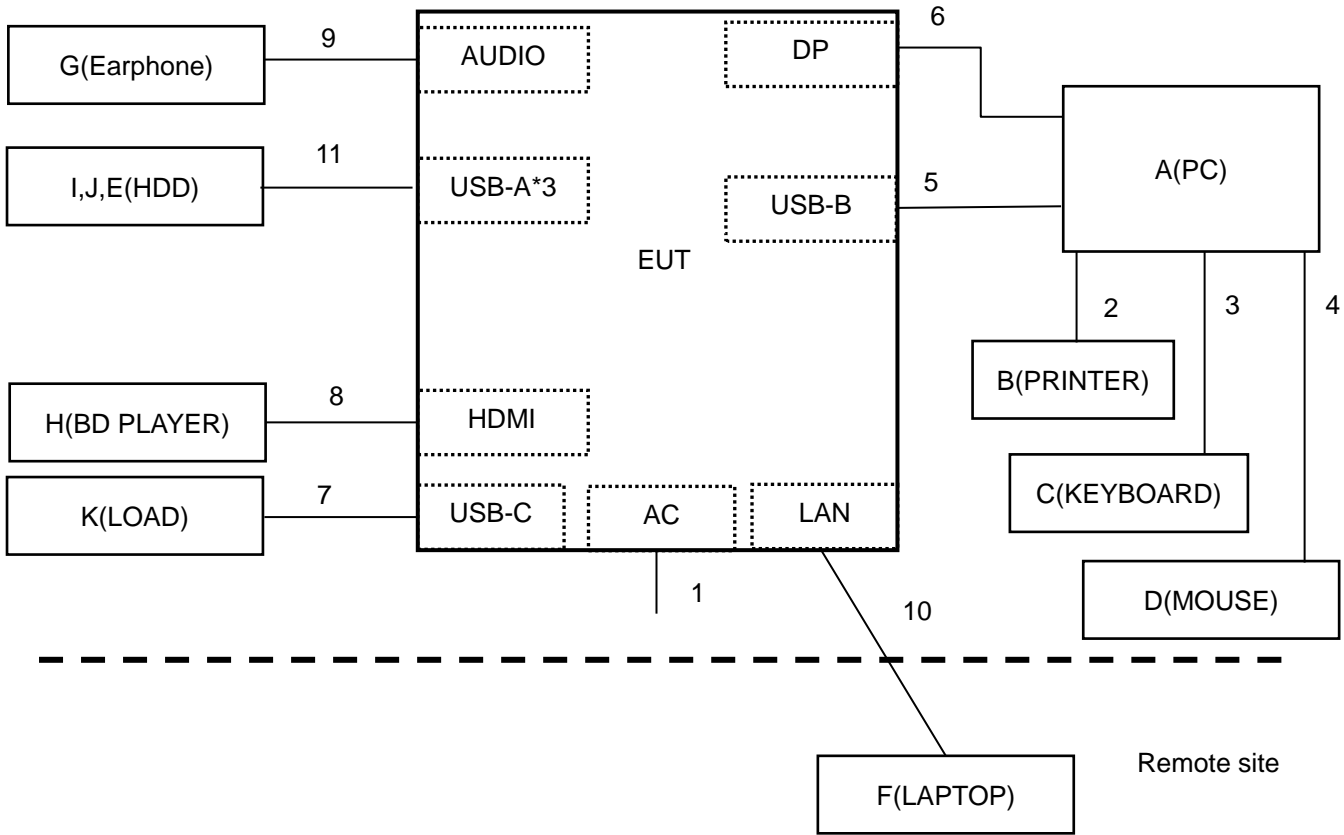

For Harmonics, Flicker & Immunity tests

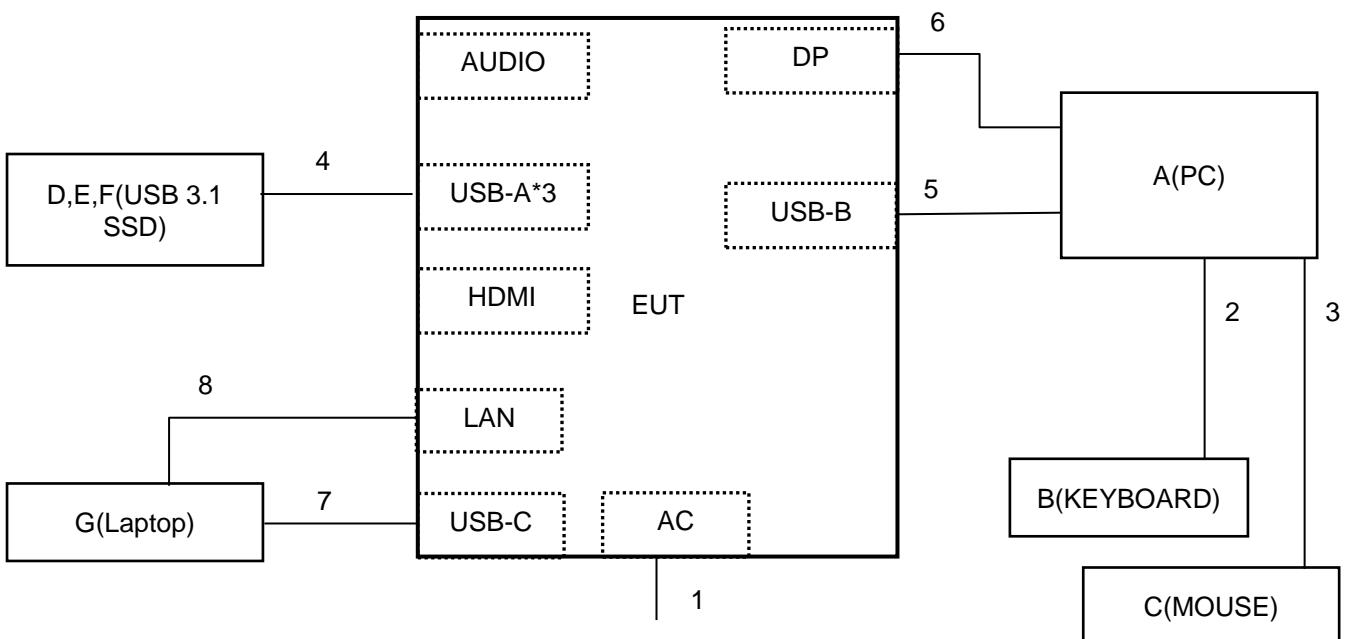

3.7 Configuration of Peripheral Devices and Cable Connections

For Emission test (Harmonics & Flicker excluded)

ID	Product	Brand	Model No.	Serial No.	FCC ID	Remarks
A	PC	ASUS	G15CE	MCPFCG026007530	N/A	Provided by Lab
B	PRINTER	HP	Officejet Pro 251dw	CN55FCV012	DoC	Provided by Lab
C	Keyboard	Dell	KB216t	CN-0W33XP- LO300-7CL-1903	N/A	Provided by Lab
D	Mouse	DELL	MOCZUL	CN-049TWY- PRC00-77B-0080	N/A	Provided by Lab
E	HDD	Transcend	ESD370C	G88779-0202	DoC	Provided by Lab
F	Laptop	LENOVO	T480	PF1EK03U	N/A	Provided by Lab
G	EARPHONE	PHILIPS	SBC HL150	H2010155	N/A	Provided by Lab
H	DB PLAYER	SONY	BDP-S7200	3200138	DoC	Provided by Lab
I	HDD	G-DRIVE	0G04878	620XJ6RW	DoC	Provided by Lab
J	HDD	G-DRIVE	0G04878	620XHEMW	DoC	Provided by Lab
K	LOAD	ADT	L19A	L2-010014	N/A	Provided by Lab

ID	Cable Descriptions	Qty.	Length (m)	Shielding (Yes/No)	Cores (Qty.)	Remarks
1	AC power cable	1	1.8	No	0	Provided by Lab
2	USB cable	1	1.8	Yes	0	Provided by Lab
3	USB cable	1	1.8	Yes	0	Provided by Lab
4	USB cable	1	1.8	Yes	0	Provided by Lab
5	USB 3.0 cable	1	1.8	Yes	0	Supplied by applicant
6	DP cable	1	1.8	Yes	0	Supplied by applicant
7	Type C to C cable	1	1.5	Yes	0	Supplied by applicant
8	HDMI cable	1	1.8	Yes	0	Supplied by applicant
9	Audio (3.5") cable	1	1.2	No	0	Provided by Lab
10	RJ45 (Cat. 5e) cable	1	10	No	0	Provided by Lab
11	USB Type A to C cable	3	1	Yes	0	Provided by Lab

For Harmonics, Flicker & Immunity tests

ID	Product	Brand	Model No.	Serial No.	FCC ID	Remarks
A	PC	ASUS	G15CE	MCPFCG025994533	N/A	Provided by Lab
B	KEYBOARD	HP	SK-2085	N/A	N/A	Provided by Lab
C	USB Mouse	Microsoft	1113	9170515897028	DoC	Provided by Lab
D	USB 3.1 SSD	WD	WDBK VX5120PSL	1922JG400125	DoC	Provided by Lab
E	USB 3.1 SSD	WD	WDBK VX5120PSL	1922JG400129	DoC	Provided by Lab
F	USB 3.1 SSD	WD	WDBK VX5120PSL	1922MD400824	DoC	Provided by Lab
G	Laptop	DELL	Latitude 5420	FHS33F3	N/A	Provided by Lab

ID	Cable Descriptions	Qty.	Length (m)	Shielding (Yes/No)	Cores (Qty.)	Remarks
1	AC power(3pin) cable	1	1.8	No	0	Provided by Lab
2	USB 2.0 cable	1	1.8	Yes	0	Provided by Lab
3	USB 2.0 cable	1	1.8	Yes	0	Provided by Lab
4	USB Type A to C cable	3	0.5	Yes	0	Provided by Lab
5	USB 3.0 cable	1	1.8	Yes	0	Supplied by applicant
6	DP cable	1	1.8	Yes	0	Supplied by applicant
7	Type C to C cable	1	1.5	Yes	0	Supplied by applicant
8	RJ45 (Cat. 5e) cable	1	10	No	0	Provided by Lab

4 Test Instruments

The calibration interval of the all test instruments are 12 months and the calibrations are traceable to NML/ROC and NIST/USA.

4.1 Conducted Emissions from Power Ports

Description Manufacturer	Model No.	Serial No.	Calibrated Date	Calibrated Until
50 ohm terminal LYNICS	0900510	E1-011285	2022/9/19	2023/9/18
		E1-011286	2022/9/19	2023/9/18
50 Ohms Terminator LYNICS	0900510	E1-01-305	2022/2/9	2023/2/8
Attenuator STI	STI02-2200-10	NO.4	2022/9/2	2023/9/1
DC LISN R&S	ESH3-Z6	100219	2022/8/2	2023/8/1
		844950/018	2022/8/2	2023/8/1
DC LISN Schwarzbeck	NNLK 8121	8121-808	2022/4/29	2023/4/28
High Voltage Probe Schwarzbeck	TK9420	00982	2022/12/14	2023/12/13
Isolation Transformer Erika Fiedler	D-65396	017	2022/9/8	2023/9/7
LISN R&S	ENV216	101196	2022/5/24	2023/5/23
LISN Schwarzbeck	NNLK 8121	8121-731	2022/5/26	2023/5/25
		8121-00759	2022/8/18	2023/8/17
	NNLK8129	8129229	2022/6/8	2023/6/7
	NNLK 8128	8128-244	2022/11/8	2023/11/7
RF Coaxial Cable Commate	5D-FB	Cable-CO5-01	2022/1/28	2023/1/27
Software BVADT	Cond_V7.3.7.4	N/A	N/A	N/A
Test Receiver R&S	ESR3	102412	2022/12/21	2023/12/20

Notes:

1. The test was performed in Linkou Conduction 5.
2. The VCCI Site Registration No. C-11093.
3. Tested Date: 2023/1/4

4.2 Conducted Emissions from Wired Network Ports

Description Manufacturer	Model No.	Serial No.	Calibrated Date	Calibrated Until
50 Ohms Terminator LYNICS	0900510	E1-01-305	2022/2/9	2023/2/8
Capacitive Voltage Probe FCC	F-CVP-1	82	2022/8/11	2023/8/10
DC LISN Schwarzbeck	NNLK 8121	8121-808	2022/4/29	2023/4/28
Impedance-stabilization-network TESEQ	ISN T8-Cat.6	53159	2022/3/22	2023/3/21
	ISN T400A	28573	2022/8/17	2023/8/16
	ISN T800	36181	2022/8/19	2023/8/18
ISN FCC	F-071115-1057-1	20650	2022/6/15	2023/6/14
		20651	2022/4/17	2023/4/16
		20652	2022/1/19	2023/1/18
	F-071115-1057-1-09	120033	2022/6/16	2023/6/15
ISN TESEQ	ISN S751	40599	2022/8/18	2023/8/17
	ISN ST08	41212	2022/8/16	2023/8/15
Isolation Transformer Erika Fiedler	D-65396	017	2022/9/8	2023/9/7
LISN R&S	ENV216	101196	2022/5/24	2023/5/23
LISN Schwarzbeck	NNLK 8121	8121-731	2022/5/26	2023/5/25
		8121-00759	2022/8/18	2023/8/17
	NNLK8129	8129229	2022/6/8	2023/6/7
	NNLK 8128	8128-244	2022/11/8	2023/11/7
RF Coaxial Cable Commate	5D-FB	Cable-CO5-01	2022/1/28	2023/1/27
RF Current Probe FCC	F-33-4	45	2022/4/27	2023/4/26
		56	2022/8/1	2023/7/31
Software BVADT	ISN_V7.3.7.4	N/A	N/A	N/A
Test Receiver R&S	ESR3	102412	2022/1/22	2023/1/21

Notes:

1. The test was performed in Linkou Conduction 5(ISN 5).
2. The VCCI Site Registration No. T-20058.
3. Tested Date: 2023/1/4

4.3 Radiated Emissions up to 1 GHz

Description Manufacturer	Model No.	Serial No.	Calibrated Date	Calibrated Until
Bi-log Broadband Antenna Schwarzbeck	VULB9168	9168-1213	2022/10/20	2023/10/19
		9168-1214	2022/10/20	2023/10/19
Coupling/Dcoupling Network Schwarzbeck	CDNE-M2	00097	2022/6/1	2023/5/31
	CDNE-M3	00091	2022/6/1	2023/5/31
Pre_Amplifier EMCI	EMC9135	980326	2022/2/17	2023/2/16
		980327	2022/2/17	2023/2/16
RF Coaxial Cable JYBAO	LMR-600	Cable-CH8-01	2022/9/23	2023/9/22
		Cable-CH8-02	2022/9/23	2023/9/22
RF Coaxial Cable Pacific	8D-FB	Cable-CH8-03	2022/9/23	2023/9/22
Software BVADT	Radiated_V8.7.08	N/A	N/A	N/A
Test Receiver R&S	ESR3	102983	2022/5/30	2023/5/29
		102984	2022/6/10	2023/6/9
Tower Max Full.	MF7802	MF780208105	N/A	N/A
Turn Table & Tower Max Full.	MF7802	MF7802121	N/A	N/A

Notes:

1. The test was performed in Linkou 10M Chamber (Chamber 8). The test site validated date: 2022/8/27 (NSA).
2. The VCCI Site Registration No. R-12946.
3. Tested Date: 2023/1/5 ~ 2023/1/6

4.4 Radiated Emissions above 1 GHz

Description Manufacturer	Model No.	Serial No.	Calibrated Date	Calibrated Until
Attenuator Mini-Circuits	BW-K3-2W44+	PAD-CH7-03	2022/7/7	2023/7/6
	BW-N4W5+	PAD-CH7-02	2022/7/7	2023/7/6
Band Pass Filter MICRO-TRONICS	BRM17690	005	2022/5/26	2023/5/25
Fix tool for Boresight antenna tower BV	BAF-01	4	N/A	N/A
Horn Antenna EMCO	3115	9312-4192	2022/11/13	2023/11/12
Horn Antenna ETS-Lindgren	3117-PA	00215857	2022/11/13	2023/11/12
Horn Antenna Schwarzbeck	BBHA-9170	BBHA9170190	2022/11/13	2023/11/12
Notch Filter MICRO-TRONICS	BRC50703-01	010	2022/5/26	2023/5/25
Pre-amplifier HP	8449B	3008A01292	2022/2/17	2023/2/16
Pre-amplifier (18GHz-40GHz) EMCI	EMC184045B	980175	2022/9/3	2023/9/2
Pre_Amplifier EMCI	EMC0126545	980076	2022/2/17	2023/2/16
	EMC184045B	980235	2022/2/17	2023/2/16
RF Coaxial Cable HUBER SUHNER	SF-102	Cable-CH7(3.6M)-02	2022/7/7	2023/7/6
Software BVADT	Radiated_V8.7.08	N/A	N/A	N/A
Spectrum Keysight	N9020B	MY60110438	2022/12/6	2023/12/5
		MY60112260	2022/5/21	2023/5/20
Test Receiver Agilent	N9038A	MY50010135	2022/8/30	2023/8/29
		MY51210114	2022/1/10	2023/1/9
Turn Table & Tower Max Full	MF7802	MF780208103	N/A	N/A

Notes:

1. The test was performed in Linkou 966 Chamber 2 (CH 7).
2. The VCCI Site Registration No. G-10039.
3. Tested Date: 2023/1/5

4.5 Harmonic Current Measurement

Description Manufacturer	Model No.	Serial No.	Calibrated Date	Calibrated Until
Harmonics and Flicker Analyzer TESEQ	PROFLINE 2105	1632A00983&1639A01863	2022/6/8	2023/6/7
Software	CTS 4	N/A	N/A	N/A

Notes:

1. The test was performed in Linkou EMS Room No.1.
2. Tested Date: 2023/1/10

4.6 Voltage Fluctuations and Flicker Measurement

Refer to section 4.5 to get information of the instruments.

4.7 Electrostatic Discharges (ESD)

Description Manufacturer	Model No.	Serial No.	Calibrated Date	Calibrated Until
Electronic Discharge Simulator Noiseken	ESS-2000	ESS0382041	2022/10/7	2023/10/6
ESD Generator EM Test	Dito//DM-150/330//DM- 150/330-rfci	P1315117252/P1317117852	2022/7/7	2023/7/6
ESD Simulator KeyTek	MZ15/EC	0504259	2022/11/8	2023/11/7
ESD Simulator TESEQ	NSG 438	1364	2022/12/2	2023/12/1

Notes:

1. The test was performed in Linkou ESD Room No.03.
2. Tested Date: 2023/1/12

4.8 Radio Frequency Electromagnetic Field (RS)

Description Manufacturer	Model No.	Serial No.	Calibrated Date	Calibrated Until
Amplifier TESEQ	CBA 1G-150	T44220	N/A	N/A
Amplifier TESTQ	AS1860-50	S-5944/1	N/A	N/A
	CBA 3G-050	T44345	N/A	N/A
Audio analyzer R&S	UPV	104565	2022/5/10	2023/5/9
Band pass filter B&K	WH3278	N/A	2022/6/5	2023/6/4
CHANCE MOST Compact Full Anechoic Chamber (7x3x3 m)	N/A	N/A	2022/1/18	2023/1/17
Ear Simulator Telephonometry B&K	4185	2553594	N/A	N/A
Power Meter BOONTON	4232A	94901	2022/6/6	2023/6/5
Power Sensor BOONTON	51011-EMC	32807	2022/6/6	2023/6/5
Pressure-field Microphone B&K	4192	2735408	2022/4/26	2023/4/25
RF Generator TESEQ	ITS 6006	37543	2022/5/10	2023/5/9
RS antenna schwarzbeck mess-elektronik	STLP 9129	9129068	N/A	N/A
Software BVADT	BV ADT_ABMS_ V7.4.3	N/A	N/A	N/A
Software BVADT	RS_V7.6	N/A	N/A	N/A
Two channel microphone conditioning amplifier B&K	2690 A OS2	2645274	2022/6/5	2023/6/4
Wireless Connection Tester R&S	CMW270	101075	2022/4/18	2023/4/17

Notes:

1. The test was performed in Linkou RS Room No.1.
2. Tested Date: 2023/1/11

4.9 Fast Transients Common Mode (EFT)

Description Manufacturer	Model No.	Serial No.	Calibrated Date	Calibrated Until
Burst generator Haefely	PEFT 4010	154954	2022/3/29	2023/3/28

Notes:

1. The test was performed in Linkou EFT Room.
2. Tested Date: 2023/1/10

4.10 Surges

Description Manufacturer	Model No.	Serial No.	Calibrated Date	Calibrated Until
Coupling Decoupling Network TESEQ	CDN HSS-2	41009	2022/4/18	2023/4/17
EMC Immunity Tester EMC PARTNER	TRANSIENT 2000	622	2022/3/7	2023/3/6
Modular Impulse Generator EMC-Partner	MIG0603IN3 IEC-ANSI	352	2022/8/2	2023/8/1

Notes:

1. The test was performed in Linkou EMS Room No.1.
2. Tested Date: 2023/1/10

4.11 Radio Frequency Common Mode (CS)

Description Manufacturer	Model No.	Serial No.	Calibrated Date	Calibrated Until
Amplifier AR	75A250AM1	306331	N/A	N/A
Audio analyzer R&S	UPV	104565	2022/5/10	2023/5/9
CDN FCC	FCC-801-M5-50A	100018	2022/1/18	2023/1/17
CDN TESEQ	CDN S200	53490	2022/2/24	2023/2/23
	CDN S400	52115	2022/2/24	2023/2/23
CDN Calibration Kit TESEQ	CDN T8S	29459	2022/2/22	2023/2/21
CDN M2-16Amp FCC	FCC-801-M2-16A	01047	2022/2/23	2023/2/22
Coupling Decoupling Network TESEQ	CDN M432S	56519	2022/2/23	2023/2/22
	CDN S751A	56435	2022/2/21	2023/2/20
		56436	2022/2/22	2023/2/21
	CDN ST08A	56525	2022/2/21	2023/2/20
		56527	2022/2/21	2023/2/20
	CDN T2A-10	54942	2022/2/22	2023/2/21
	CDN T8-10	40376	2022/2/22	2023/2/21
	CDN T8-230	56641	2022/2/22	2023/2/21
		56642	2022/2/22	2023/2/21
		56643	2022/2/22	2023/2/21
CDN T800	34428	2022/2/22	2023/2/21	
CDN T400A	49918	2022/2/23	2023/2/22	
Coupling/Dcoupling Network EM TEST	CDN M1/32A	306508	2022/2/23	2023/2/22
Coupling/Dcoupling Network TESEQ	CDN M232	37702	2022/2/23	2023/2/22
	CDN M332	41256	2022/2/23	2023/2/22
		41258	2022/2/23	2023/2/22
Current Clamp FCC	F-120-9A	361	2022/8/17	2023/8/16
Digital Sweep Function Generator Topward	8120	984801	N/A	N/A
Ear Simulator Telephonometry B&K	4185	2553594	N/A	N/A
FCC EM Injection Clamp FCC	F-203I-23mm	455	N/A	N/A
Mouth Simulator B&K	4227	2630632	N/A	N/A
POWER AMPLIFIER B&K	2716C	2610979	N/A	N/A
Power Meter R & S	NRVD	837794/040	2022/10/18	2023/10/17
Power Sensor R & S	NRV-Z5	837878/039	2022/10/18	2023/10/17

Description Manufacturer	Model No.	Serial No.	Calibrated Date	Calibrated Until
Pressure-field Microphone B&K	4192	2735407	2022/11/15	2023/11/14
SIGNAL GENERATOR R&S	SML03	101364	2022/8/16	2023/8/15
Software BVADT	ABMS_ V7.4.3	N/A	N/A	N/A
Software BVADT	CS_V7.4.2	N/A	N/A	N/A
Two channel microphone conditioning amplifier B&K	2690 OS2	3001996	2022/11/15	2023/11/14
Wireless Connection Tester R&S	CMW270	101075	2022/4/18	2023/4/17

Notes:

1. The test was performed in Linkou CS Room No.1.
2. Tested Date: 2023/1/10

4.12 Power Frequency Magnetic Field (PFMF)

Description Manufacturer	Model No.	Serial No.	Calibrated Date	Calibrated Until
F.W.BELL 4190 Gaussmeter F.W. Bell	4190	0743043	2022/4/13	2023/4/12
Magnetic field generator NARDA	PMM 1008	0100X30701	2022/8/23	2023/8/22

Notes:

1. The test was performed in Linkou EMS Room No.02.
2. Tested Date: 2023/1/10

4.13 Voltage Dips and Interruptions (DIP)

Description Manufacturer	Model No.	Serial No.	Calibrated Date	Calibrated Until
Harmonics and Flicker Analyzer TESEQ	PROFLINE 2105	1632A00983&1639A01863	2022/6/8	2023/6/7
Software	WIN2120	N/A	N/A	N/A

Notes:

1. The test was performed in Linkou EMS Room No.1.
2. Tested Date: 2023/1/10

5 Limits of Test Items

5.1 Conducted Emissions from Power Ports

Frequency (MHz)	Class A (dB μ V)		Class B (dB μ V)	
	Quasi-peak	Average	Quasi-peak	Average
0.15 - 0.5	79	66	66 - 56	56 - 46
0.50 - 5.0	73	60	56	46
5.0 - 30.0	73	60	60	50

Notes: 1. The lower limit shall apply at the transition frequencies.
 2. The limit decreases linearly with the logarithm of the frequency in the range of 0.15 to 0.50 MHz.

5.2 Conducted Emissions from Wired Network Ports

Frequency (MHz)	Coupling Device	Class A				Class B			
		Voltage Limit (dB μ V)		Current limits (dB μ A)		Voltage Limit (dB μ V)		Current limits (dB μ A)	
		Quasi-peak	Average	Quasi-peak	Average	Quasi-peak	Average	Quasi-peak	Average
0.15-0.5	Using AAN	97-87	84-74	-	-	84-74	74-64	-	-
0.5-30		87	74	-	-	74	64	-	-
0.15-0.5	Using CVP and Current probe	97-87	84-74	53-43	40-30	84-74	74-64	40-30	30-20
0.5-30		87	74	43	30	74	64	30	20
0.15-0.5	Using a 150 Ω load	-	-	53-43	40-30	-	-	40-30	30-20
0.5-30		-	-	43	30	-	-	30	20

Note: The limits decrease linearly with the logarithm of the frequency in the range 0.15 MHz to 0.5 MHz.

5.3 Radiated Emissions up to 1 GHz

Frequency (MHz)	Class A		Class B	
	Quasi-peak (dB μ V/m)		Quasi-peak (dB μ V/m)	
	at 3m	at 10m	at 3m	at 10m
30 - 230	50	40	40	30
230 - 1000	57	47	47	37

Notes: 1. The lower limit shall apply at the transition frequencies.
 2. Emission level (dB μ V/m) = 20 log Emission level (μ V/m).
 3. All emanations from a class A/B digital device or system, including any network of conductors and apparatus connected thereto, shall not exceed the level of field strengths specified above.

5.4 Radiated Emissions above 1 GHz

EN 55032

Frequency (GHz)	Class A (dBuV/m) (at 3m)		Class B (dBuV/m) (at 3m)	
	Average	Peak	Average	Peak
1 to 3	56	76	50	70
3 to 6	60	80	54	74

- Notes: 1. The lower limit shall apply at the transition frequencies.
 2. Emission level (dBuV/m) = 20 log Emission level (uV/m).
 3. All emanations from a class A/B digital device or system, including any network of conductors and apparatus connected thereto, shall not exceed the level of field strengths specified above.

Frequency Range of Radiated Measurement (For unintentional radiators)

Highest internal frequency (F_x)	Highest measurement frequency (F_M) (GHz)
$F_x \leq 108 \text{ MHz}$	1
$108 \text{ MHz} < F_x \leq 500 \text{ MHz}$	2
$500 \text{ MHz} < F_x \leq 1 \text{ GHz}$	5
$F_x > 1 \text{ GHz}$	$5 \times F_x$ up to a maximum of 6 GHz

F_x is the highest fundamental frequency generated and/or used in the ITE or digital apparatus under test.

AS/NZS CISPR 32

Frequency (GHz)	Class A (dBuV/m) (at 3 m)		Class B (dBuV/m) (at 3 m)	
	Average	Peak	Average	Peak
1 to 6	60	80	54	74

- Notes: 1. The lower limit shall apply at the transition frequencies.
 2. Emission level (dBuV/m) = 20 log Emission level (uV/m).
 3. All emanations from a class A/B digital device or system, including any network of conductors and apparatus connected thereto, shall not exceed the level of field strengths specified above.

Frequency Range of Radiated Measurement (For unintentional radiators)

Highest frequency generated or used in the EUT or on which the EUT operates or tunes (MHz)	Upper frequency of measurement range (MHz)
Below 108	1000
108-500	2000
500-1000	5000
Above 1000	Up to 5 times of the highest frequency or 6 GHz, whichever is less

Remark : Due to the radiated emission limit (1 GHz to 3 GHz) in AS/NZS CISPR 32 is changed and relaxation than standard EN 55032. Therefore, the radiated emission limit of EN 55032 is met, then AS/NZS CISPR 32 is considered met.

5.5 Harmonic Current Measurement

Limits for Class A equipment		Limits for Class D equipment		
Harmonic Order n	Max. permissible harmonics current A	Harmonic Order n	Max. permissible harmonics current per watt mA/W	Max. permissible harmonics current A
Odd harmonics		Odd Harmonics only		
3	2.30	3	3.4	2.30
5	1.14	5	1.9	1.14
7	0.77	7	1.0	0.77
9	0.40	9	0.5	0.40
11	0.33	11	0.35	0.33
13	0.21	13	0.30	0.21
$15 \leq n \leq 39$	$0.15 \times 15/n$	$15 \leq n \leq 39$	$3.85/n$	$0.15 \times 15/n$
Even harmonics				
2	1.08			
4	0.43			
6	0.30			
$8 \leq n \leq 40$	$0.23 \times 8/n$			

Notes: 1. Class A and Class D are classified according to section 5 of EN 61000-3-2.

2. According to section 7 of EN 61000-3-2, the above limits for all equipment except for lighting equipment having an active input power > 75 W and no limits apply for equipment with an active input power up to and including 75 W.

Classification of equipment

Class A	Class B	Class C	Class D
Balanced three-phase equipment; Household appliances excluding equipment as Class D; Tools excluding portable tools; Dimmers for incandescent lamps; Audio equipment; Equipment not specified in one of the three other classes.	Portable tools; Arc welding equipment which is not professional equipment.	Lighting equipment.	Equipment having a specified power less than or equal to 600 W of the following types: Personal computers and personal computer monitors; Television receivers; Refrigerators and freezers having one or more variable-speed drives to control compressor motor(s).

5.6 Voltage Fluctuations and Flicker Measurement

Test Item	Limit	Note
P_{st}	1.0	P_{st} means short-term flicker indicator.
P_{lt}	0.65	P_{lt} means long-term flicker indicator.
T_{dt} (ms)	500	T_{dt} means maximum time that d(t) exceeds 3.3 %.
d_c (%)	3.3%	d_c means relative steady-state voltage change
d_{max} (%)		d_{max} means maximum relative voltage change. Control Method of Equipment (see below)
	4%	<input checked="" type="checkbox"/> - without additional conditions
	6%	<input type="checkbox"/> - switched manually, or - switched automatically more frequently than twice per day, and also has either a delayed restart (the delay not less than a few tens of seconds), or manual restart, after a power supply interruption
	7%	<input type="checkbox"/> - attended whilst in use (for example: hair dryers, vacuum cleaners, kitchen equipment such as mixers, garden equipment such as lawn mowers, portable tools such as electric drills), or switched on automatically, or - is intended to be switched on manually, no more than twice per day, and also has either a delayed restart (the delay being not less than a few tens of seconds) or manual restart, after a power supply interruption.

5.7 General immunity requirements

Port	Basic Standard	Test item	Test specification	Performance criteria	
Power input (AC)	IEC 61000-4-4	Fast Transients, Common Mode (EFT)	±1 kV 5/50 ns (Tr/Th) 5 kHz, repetition frequency	B	
	IEC 61000-4-5	Surge	Line to line: ±1 kV, 1.2/50 µs Line to earth: ±2 kV, 1.2/50 µs	B	
	IEC 61000-4-6	Radio Frequency, Common Mode (CS)	0.15-10 MHz, 3V, 80% AM (1kHz), 10-30 MHz, 3V-1V, 80% AM (1kHz), 30-80 MHz, 1V, 80% AM (1kHz),	A	
	IEC 61000-4-11	Voltage dips and interruptions (DIP)	Voltage Dips: < 5 % residual voltage, 0.5 cycle 70% residual voltage, 25 cycles (at 50Hz) Voltage Interruption: < 5 % residual voltage, 250 cycles (at 50 Hz)	B C C	
DC power/ Wired network and Signal/ Control port	IEC 61000-4-4	Fast Transients, Common Mode (EFT)	±0.5 kV 5/50 ns (Tr/Th) 100 kHz, repetition frequency for xDSL port 5 kHz, repetition frequency for other port	B	
	IEC 61000-4-5	Surge	Wired network ports (directly connected to outdoor cables): Symmetrically operated: 10/700µs w/o primary protectors: ±1.0kV, or with primary protectors fitted: ±1.0kV and ±4.0kV, Coaxial or shielded operated: 1.2/50µs shield to ground: ±0.5 kV,	C B	
			DC power ports (directly connected to outdoor cables): 1.2/50 µs each individual line to earth, or shield to ground: ±0.5 kV,	B	
	IEC 61000-4-6	Broadband impulse noise disturbances (Applicable only to xDSL ports.)	Radio Frequency, Common Mode (CS)	0.15-10 MHz, 3V, 80% AM (1kHz), 10-30 MHz, 3V-1V, 80% AM (1kHz), 30-80 MHz, 1V, 80% AM (1kHz),	A
			Repetitive : Impulse frequency profile : 0.15 – 0.5 MHz, 107 dBuV ; 0.5 – 10 MHz, 107 – 36 dBuV ; 10 – 30 MHz, 36 – 30 dBuV Burst duration : 0.70 ms Burst period :10 ms(for 50 Hz) At least 2 minutes for each port under test. Isolated : Impulse frequency profile : 0.15 –30 MHz, 110 dBuV Burst duration : 0.24 ms, 10 ms and 300 ms Isolated impulses : 5 times Interval : at least 60 seconds	A B	

Port	Basic Standard	Test item	Test specification	Performance criteria
Enclosure	IEC 61000-4-2	Electrostatic Discharge (ESD)	±4 kV (contact) ±8 kV (Air)	B
	IEC 61000-4-3	Radio Frequency Electromagnetic Field (RS)	Swept Frequency Test: 80 to 1000(MHz), 3 V/m, 80 % AM (1 kHz) Spot Frequency Test: 1800, 2600, 3500, 5000 MHz (±1 %), 3V/m, 80% AM (1kHz)	A
	IEC 61000-4-8	Power Frequency Magnetic Field (PFMF)	1A/m, 50Hz	A

6.2 Conducted Emissions from Wired Network Ports

Method of Using AANs:

- The EUT is placed 0.4 meters from the conducting wall of the shielded room and connected to AAN directly to reference ground plane.
- If voltage measurement is used, measure voltage at the measurement port of the AAN, correct the reading by adding the AAN voltage division factor, and compare to the voltage limit.
- It is not necessary to apply the current limit if a AAN is used.
- The test results of disturbance at telecommunication ports are recorded of six worst margins for quasi-peak (mandatory) [and average (if necessary)] values against the limits at frequencies of interest unless the margin is 20 dB or greater.

Note: The resolution bandwidth and video bandwidth of test receiver is 9kHz for quasi-peak detection (QP) and average detection (AV) at frequency 0.15MHz-30MHz.

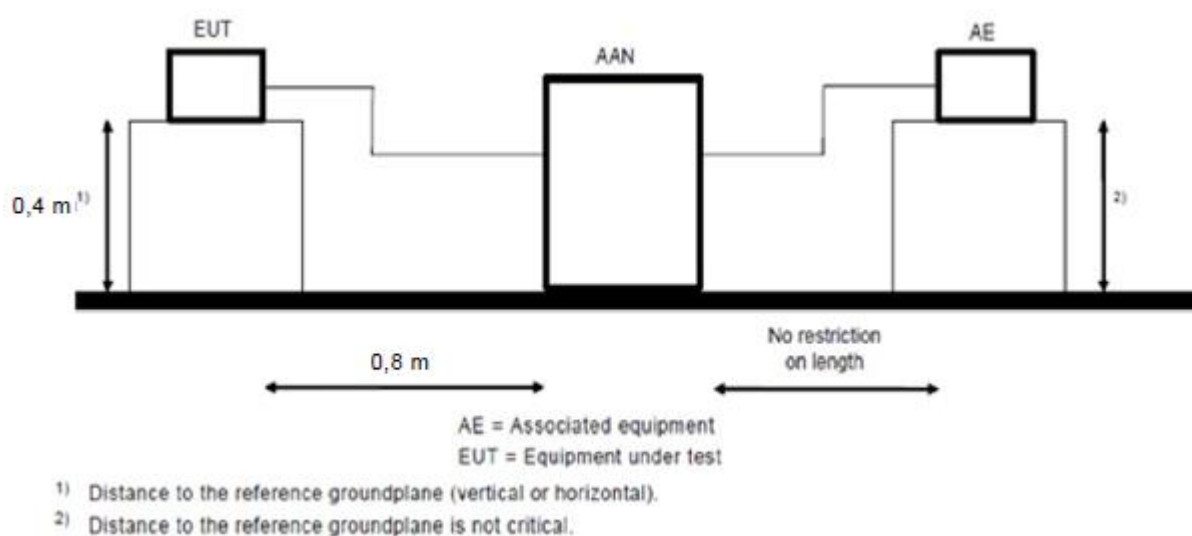

For the actual test configuration, please refer to the related Item – Photographs of the Test Configuration.

Method of Using a 150 Ω load to the outside surface of the shielding cable:

- Breaks the external protective insulation (exposing the shield) and connect a 150Ω resistor from the outside surface of the shield to ground.
- A current probe shall be placed at 0.1 m from the 150Ω resistor. The current probe to EUT horizontal distance is between 0.3 m to 0.8 m.
- If current measurement is used, measure current at the measurement port of the current probe, correct the reading by adding the current probe division factor, and compare to the current limit.
- It is not necessary to apply the voltage limit if a current probe is used.
- The test results of disturbance at telecommunication ports are recorded of six worst margins for quasi-peak (mandatory) [and average (if necessary)] values against the limits at frequencies of interest unless the margin is 20 dB or greater.

Note: The resolution bandwidth and video bandwidth of test receiver is 9kHz for quasi-peak detection (QP) and average detection (AV) at frequency 0.15MHz-30MHz.

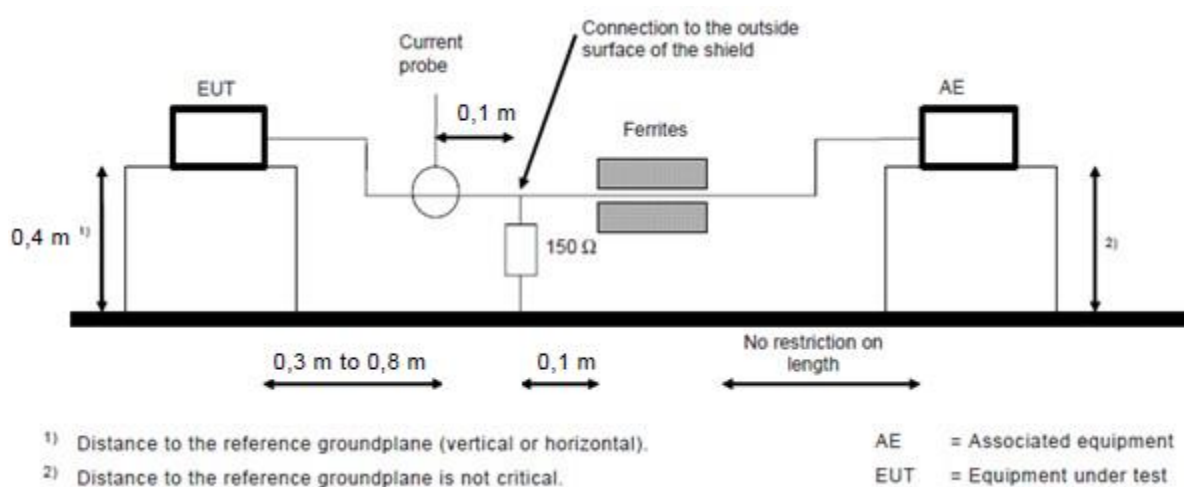

For the actual test configuration, please refer to the related Item – Photographs of the Test Configuration.

Method of Using a combination of current probe and capacitive voltage probe:

- a. Measure current with a current probe.
- b. Compare the measured current with the applicable current limit.
- c. Measure voltage with a capacitive voltage probe as specified in 5.2.2 of CISPR 16-1-2.
- d. Adjust the measured voltage as follows:
 - current margin ≤ 6 dB – subtract the actual current margin from measured voltage;
 - current margin > 6 dB – subtract 6 dB from measured voltage.
- e. Compare adjusted voltage with the applicable voltage limit
- f. Both the measured current and the adjusted voltage shall be below the applicable
- g. The test results of disturbance at telecommunication ports are recorded of six worst margins for quasi-peak (mandatory) [and average (if necessary)] values against the limits at frequencies of interest unless the margin is 20 dB or greater.

Note: The resolution bandwidth and video bandwidth of test receiver is 9kHz for quasi-peak detection (QP) and average detection (AV) at frequency 0.15MHz-30MHz.

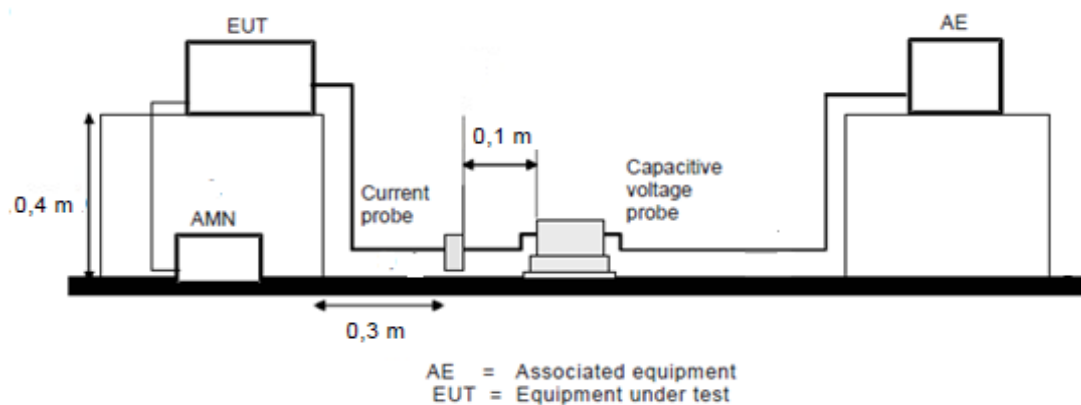

For the actual test configuration, please refer to the related Item – Photographs of the Test Configuration.

6.3 Radiated Emissions up to 1 GHz

- For the table-top EUT is placed on a 0.8 meter to the top of rotating table; for the floor standing EUT shall be insulated (by insulation of maximum thickness of 150 mm) from the horizontal reference ground plane. The rotating table is rotated 360 degrees to determine the position of the highest radiation. If the equipment requires a dedicated ground connection, this shall be provided and bonded to the RGP.
- The EUT is set 10 meters away from the interference-receiving antenna, which is mounted on the top of a variable-height antenna tower.
- The antenna is a broadband antenna, and its height is varied from one meter to four meters above the ground to determine the maximum value of the field strength. Both horizontal and vertical polarizations of the antenna are set to make the measurement.
- For each suspected emission, the EUT is arranged to its worst case and then the antenna is tuned to heights from 1 m to 4 m and the rotatable table was turned from 0 degrees to 360 degrees to find the maximum reading.
- The test-receiver system is set to quasi-peak detect function and specified bandwidth with maximum hold mode when the test frequency is up to 1 GHz.

Note: The resolution bandwidth and video bandwidth of test receiver/spectrum analyzer is 120kHz for quasi-peak detection (QP) at frequency up to 1GHz.

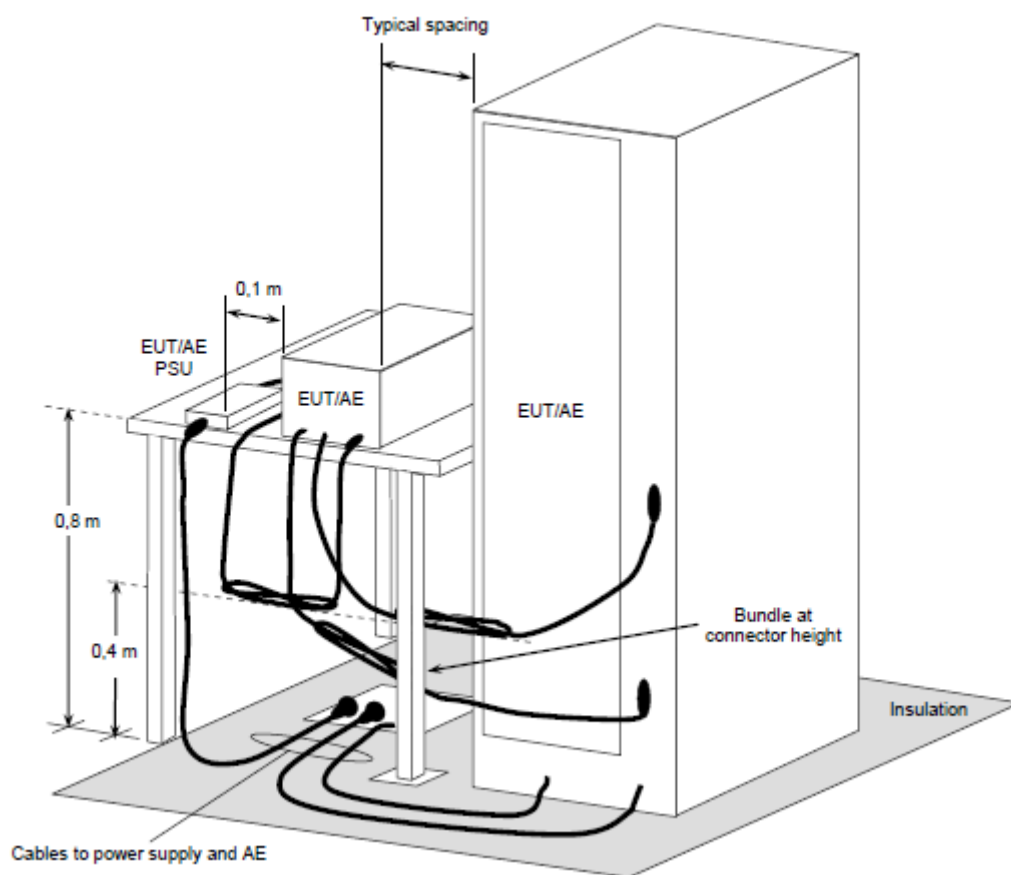

For the actual test configuration, please refer to the related Item – Photographs of the Test Configuration.

6.4 Radiated Emissions above 1 GHz

- For the table-top EUT is placed on a 0.8 meter to the top of rotating table; for the floor standing EUT shall be insulated (by insulation of 12 mm) from the horizontal reference ground plane. The rotating table is rotated 360 degrees to determine the position of the highest radiation. If the equipment requires a dedicated ground connection, this shall be provided and bonded to the RGP.
- The EUT was set $d = 3$ meters away from the interference-receiving antenna, which was mounted on the top of a variable-height antenna tower.
- The height of antenna can be varied from one meter to four meters, the height of adjustment depends on the EUT height and the antenna 3dB beamwidth both, to detect the maximum value of the field strength. Both horizontal and vertical polarizations of the antenna are set to make the measurement.
- For each suspected emission, the EUT was arranged to its worst case and then the antenna was tuned to heights and the rotatable table was turned from 0 degrees to 360 degrees to find the maximum reading.
- The spectrum analyzer system was set to peak and average detects function and specified bandwidth with maximum hold mode when the test frequency is above 1 GHz.

Note: The resolution bandwidth of test receiver/spectrum analyzer is 1MHz and video bandwidth is 3MHz for Peak detection (PK) at frequency above 1GHz. The resolution bandwidth of test receiver/spectrum analyzer is 1 MHz for Average detection (AV) at frequency above 1GHz.

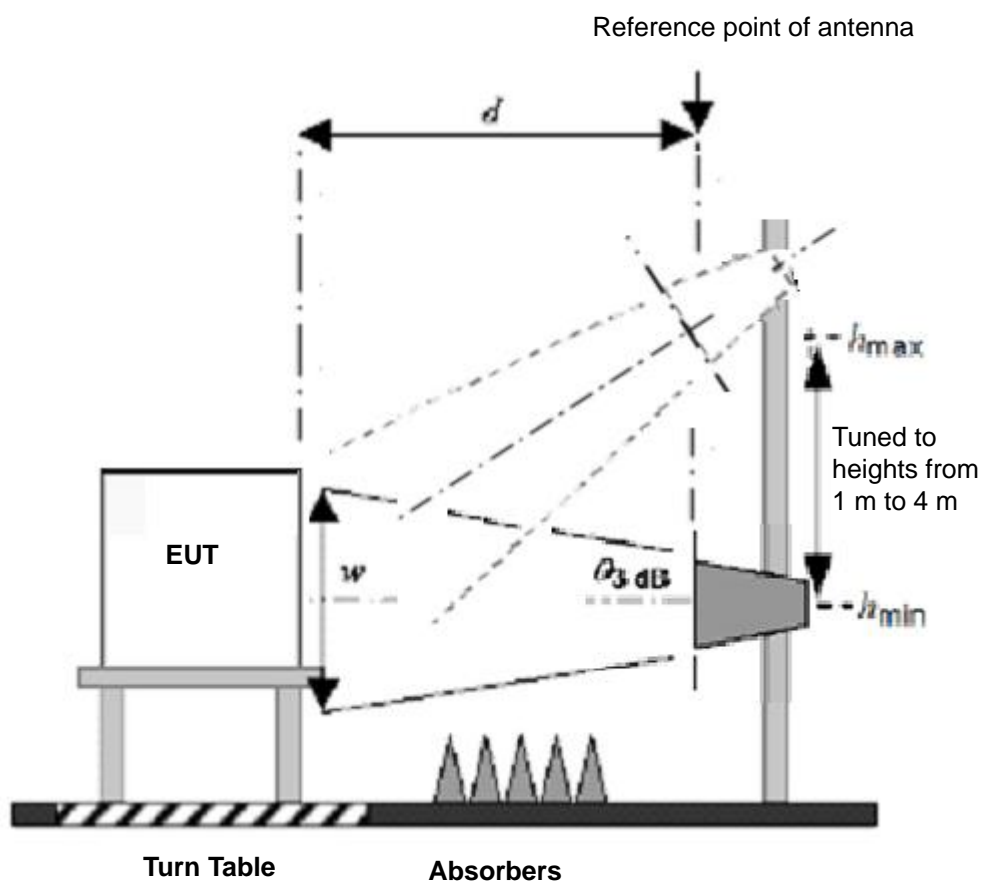

For the actual test configuration, please refer to the related item – Photographs of the Test Configuration.

6.5 Harmonic Current Measurement

- The harmonic current limits apply to line currents and not to currents in the neutral conductor. Nevertheless, for single-phase equipment, it is permissible to measure the currents in the neutral conductor instead of the currents in the line.
- The EUT is tested as presented by, and in accordance with information provided by, the manufacturer. Preliminary operation of motor drives by the manufacturer may be needed before the tests are undertaken to ensure that results correspond with normal use.
- In all configurations, the use of additional load shall not cause the total output power available to be exceeded.
- The correspondent test program of test instrument to measure the current harmonics emanated from EUT is chosen. The measure time shall be not less than the time necessary for the EUT to be exercised.

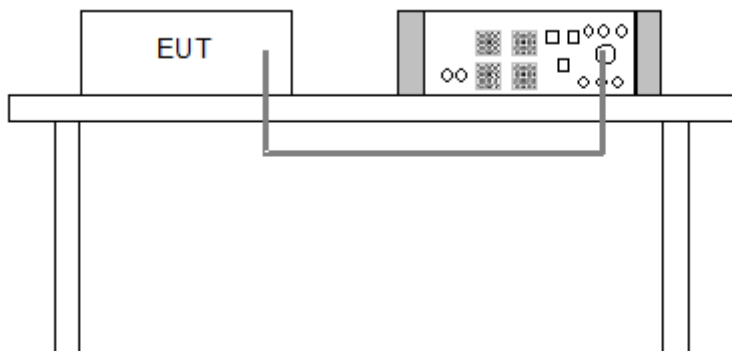

For the actual test configuration, please refer to the related Item – Photographs of the Test Configuration.

6.6 Voltage Fluctuations and Flicker Measurement

- Controls or automatic programs of the EUT shall be set to produce the most unfavourable sequence of voltage changes, using only those combinations of controls and programmes which are mentioned by the manufacturer in the instruction manual, or are otherwise likely to be used.
- Preliminary operation of motor drives may be needed before the tests to ensure that results corresponding to those of normal use are obtained.
- During the flick measurement, the measure time shall include that part of whole operation cycle in which the EUT produce the most unfavorable sequence of voltage changes. The observation period for short-term flicker indicator is 10 minutes and the observation period for long-term flicker indicator is 2 hours.

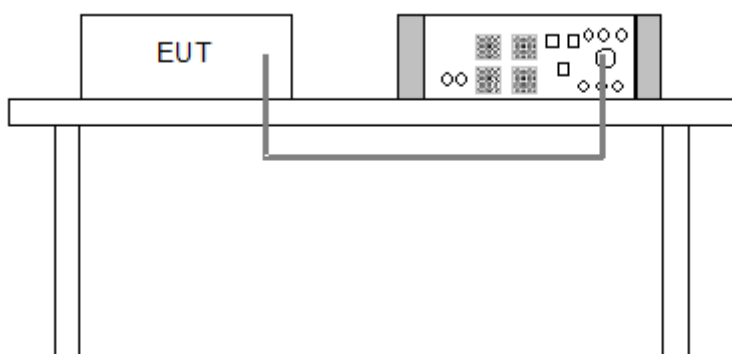

For the actual test configuration, please refer to the related Item – Photographs of the Test Configuration.

6.7 Electrostatic Discharges (ESD)

Discharge Impedance:	330 ohm / 150 pF
Number of Discharge:	Air – Direct: 10 discharges per location (each polarity) Contact – Direct & Indirect: 10 discharges per location (each polarity)
Discharge Period:	1-second minimum

The basic test procedure was in accordance with EN/IEC 61000-4-2:

- a. Electrostatic discharges were applied only to those points and surfaces of the EUT that are accessible to users during normal operation.
- b. The test was performed with at least ten single discharges on the pre-selected points in the most sensitive polarity.
- c. The time interval between two successive single discharges was at least 1 second.
- d. The ESD generator was held perpendicularly to the surface to which the discharge was applied and the return cable was at least 0.2 meters from the EUT.
- e. Contact discharges were applied to the non-insulating coating, with the pointed tip of the generator penetrating the coating and contacting the conducting substrate.
- f. Air discharges were applied with the round discharge tip of the discharge electrode approaching the EUT as fast as possible (without causing mechanical damage) to touch the EUT. After each discharge, the ESD generator was removed from the EUT and re-triggered for a new single discharge. The test was repeated until all discharges were complete.
- g. At least ten single discharges (in the most sensitive polarity) were applied to the **Horizontal Coupling Plane** at points on each side of the EUT. The ESD generator was positioned at a distance of 0.1 meters from the EUT with the discharge electrode touching the **HCP**.
- h. At least ten single discharges (in the most sensitive polarity) were applied to the center of one vertical edge of the **Vertical Coupling Plane** in sufficiently different positions that the four faces of the EUT were completely illuminated. The **VCP** (dimensions 0.5m x 0.5m) was placed vertically to and 0.1 meters from the EUT.

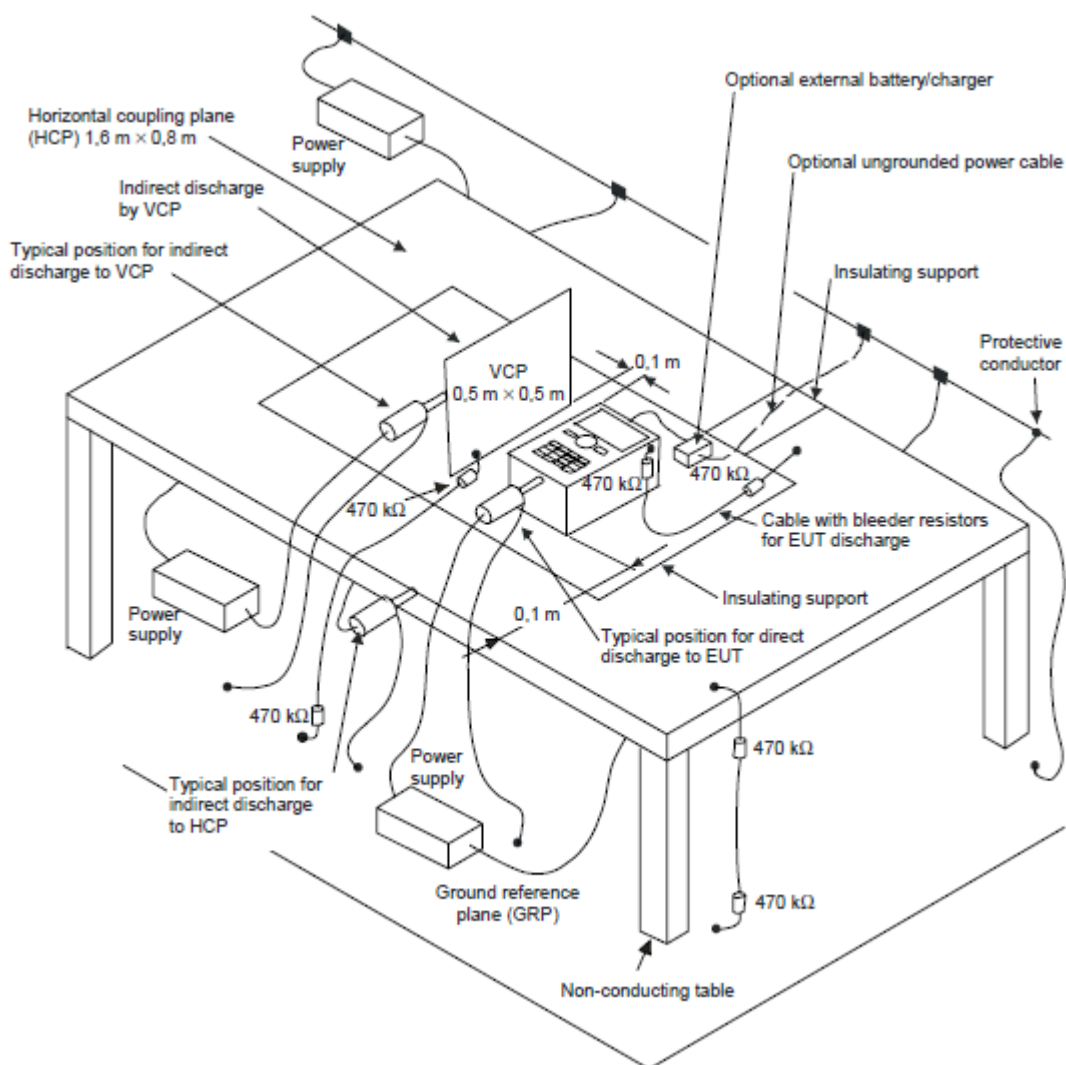

For the actual test configuration, please refer to the related item – Photographs of the Test Configuration.

NOTE:

TABLE-TOP EQUIPMENT

The configuration consisted of a wooden table 0.8 meters high standing on the **Ground Reference Plane**. The **GRP** consisted of a sheet of aluminum at least 0.25mm thick, and 2.5 meters square connected to the protective grounding system. A **Horizontal Coupling Plane** (1.6m x 0.8m) was placed on the table and attached to the **GRP** by means of a cable with 940kΩ total impedance. The equipment under test, was installed in a representative system as described in section 7 of EN/IEC 61000-4-2, and its cables were placed on the **HCP** and isolated by an insulating support of 0.5mm thickness. A distance of 1-meter minimum was provided between the EUT and the walls of the laboratory and any other metallic structure.

FLOOR-STANDING EQUIPMENT

The equipment under test was installed in a representative system as described in section 7 of IEC 61000-4-2, and its cables were isolated from the Ground Reference Plane by an insulating support of 0.1-meter thickness. The **GRP** consisted of a sheet of aluminum that is at least 0.25mm thick, and 2.5 meters square connected to the protective grounding system and extended at least 0.5 m.

6.8 Radio Frequency Electromagnetic Field (RS)

Modulation:	1kHz Sine Wave, 80%, AM Modulation
Frequency Step:	1 % of preceding frequency value
Dwell Time:	3 seconds

The test procedure was in accordance with EN/IEC 61000-4-3.

- The testing was performed in a modified semi-anechoic chamber.
- The frequency range shall be swept, with the signal 80% amplitude modulated with a 1kHz sine wave.
- The test was performed with the EUT exposed to both vertically and horizontally polarized fields on each of the four sides.

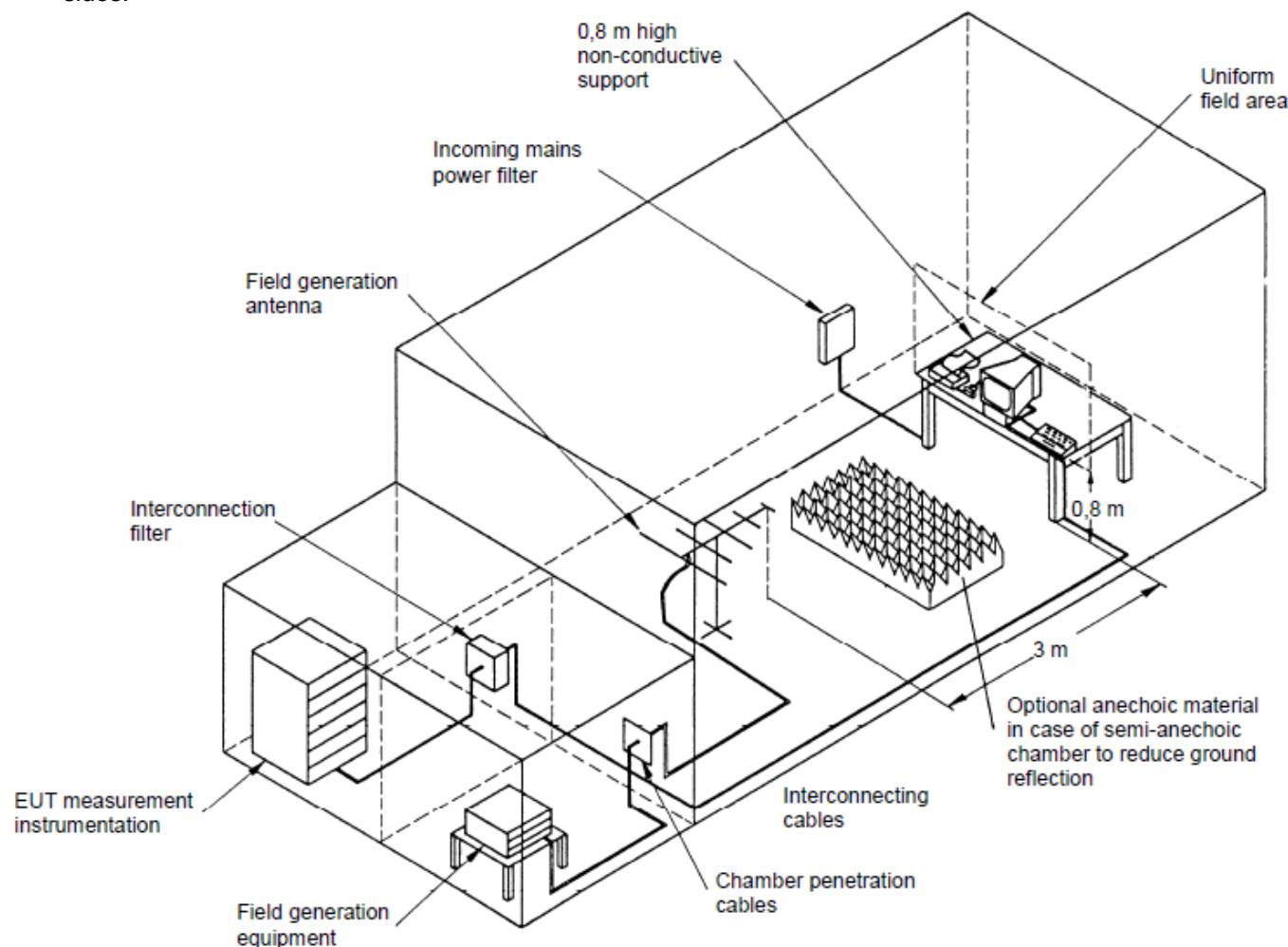

For the actual test configuration, please refer to the related item – Photographs of the Test Configuration.

NOTE:

TABLETOP EQUIPMENT

The EUT installed in a representative system as described in section 7 of EN/IEC 61000-4-3 was placed on a non-conductive table 0.8 meters in height. The system under test was connected to the power and signal wire according to relevant installation instructions.

FLOOR STANDING EQUIPMENT

The EUT installed in a representative system as described in section 7 of EN/IEC 61000-4-3 was placed on a non-conductive wood support 0.1 meters in height. The system under test was connected to the power and signal wire according to relevant installation instructions.

6.9 Fast Transients Common Mode (EFT)

Impulse Repetition Frequency:	xDSL telecommunication port: 100kHz others: 5kHz
Impulse Wave Shape:	5/50 ns
Burst Duration:	0.75 ms for 100kHz Repetition Frequency 15 ms for 5kHz Repetition Frequency
Burst Period:	300 ms
Test Duration:	1 min.

- Both positive and negative polarity discharges were applied.
- The distance between any coupling devices and the EUT should be 0.5 m for table-top equipment testing, and 1.0 m for floor standing equipment.
- The duration time of each test sequential was 1 minute.
- The transient/burst waveform was in accordance with EN/IEC 61000-4-4, 5/50 ns.

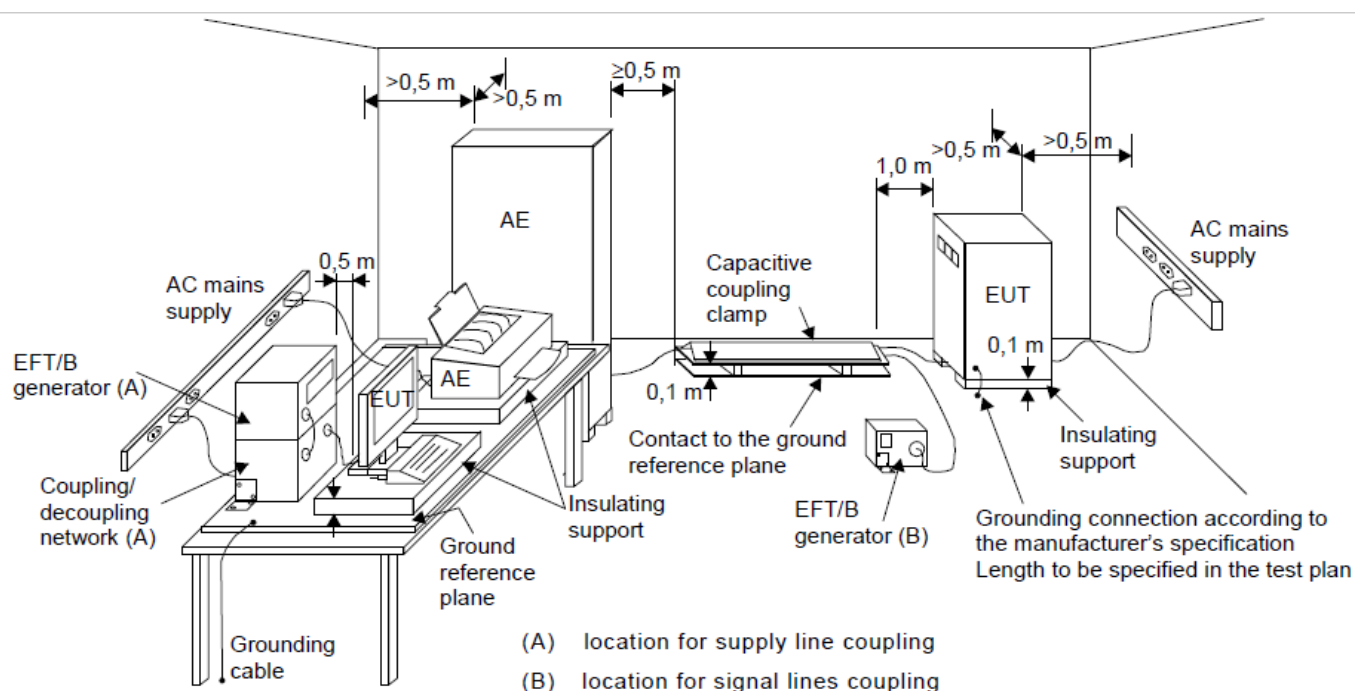

For the actual test configuration, please refer to the related item – Photographs of the Test Configuration.

6.10 Surges

Wave-Shape:	Wired network ports (direct to outdoor cables): Symmetrically operated: 10/700 μ s Open Circuit Voltage 5/320 μ s Short Circuit Current Non-symmetrically operated: 1.2/50 μ s Open Circuit Voltage 8/20 μ s Short Circuit Current Shielded cables (direct to outdoor cables): 1.2/50 μ s Open Circuit Voltage 8/20 μ s Short Circuit Current Wired network ports (indoor cables, longer than 30m): 1.2/50 μ s Open Circuit Voltage 8/20 μ s Short Circuit Current Input DC power port (direct to outdoor cables): 1.2/50 μ s Open Circuit Voltage 8/20 μ s Short Circuit Current Input AC power port: 1.2/50 μ s Open Circuit Voltage 8/20 μ s Short Circuit Current
Pulse Repetition Rate:	20 sec.
Number of Tests:	5 positive and 5 negative at selected points

a. EUT Power ports:

The surge shall be applied to the EUT power supply terminals via the capacitive coupling network. Decoupling networks are required in order to avoid possible adverse effects on equipment not under test that may be powered by the same lines and to provide sufficient decoupling impedance to the surge wave. The power cord between the EUT and the coupling network shall not exceed 2 meters in length.

For double-insulated products without PE or external earth connections, the test shall be done in a similar way as for grounded products but without adding any additional external grounded connections. If there are no other possible connections to earth, line-to-ground tests may be omitted.

b. Wired network ports

- Unshielded unsymmetrical interconnection lines:

The coupling / decoupling networks shall not influence the specified functional conditions of the EUT. The interconnection line between the EUT and the coupling network shall not exceed 2 meters in length.

No line-to-ground surges are applied for double-insulated products (i.e. products without any dedicated earth terminal).

- Unshielded symmetrical interconnection lines:

For symmetrical interconnection lines and high-speed interconnection lines, the CDN shall be selected to match the number of lines/pairs existing the cable. If coupling arrestors are use, test levels below the ignition point of the coupling arrestor cannot be specified.

The interconnection line between the EUT and the coupling/decoupling networks shall not exceed 2 meters in length.

In order to avoid the coupling and decoupling capacitors having a filtering effect on the data transfer, a balanced high frequency design associating the coupling capacitors with coupling chokes is required. Where normal functioning of high speed communications lines cannot be achieved because of the impact of the CDN on the EUT, product committees should specify appropriate operation or that no surge immunity test is required.

- Shielded lines:

The EUT is isolated from ground and the surge is applied to its metallic enclosure; the termination (or auxiliary equipment) at the port(s) under test is grounded. This test applies to equipment with one or more shielded cables.

The length of the cable between the port(s) under test and the device attached to the other end of the cable (AE in Figure 12) shall be:

- 20 m (preferred length) or,
- the shortest length over 10 m, where the manufacturer provides pre-assembled cables used in actual installations.

No test shall be required for cables which according to the manufacturer's specification are ≤ 10 m.

Rules for application of the surge to shielded lines:

- a) Shields grounded at both ends:
 – the test shall be carried out.

The test level is applied on shields with a 2 Ω generator source impedance and with the 18 μ F capacitor.

- b) Shields grounded at one end:
 – the test shall be carried out according to unshielded unsymmetrical interconnection lines or unshielded symmetrical interconnection lines because the shield does not provide any protection against surges induced by magnetic fields.

For EUTs which do not have metallic enclosures, the surge is applied directly to the shielded cable at the EUT side.

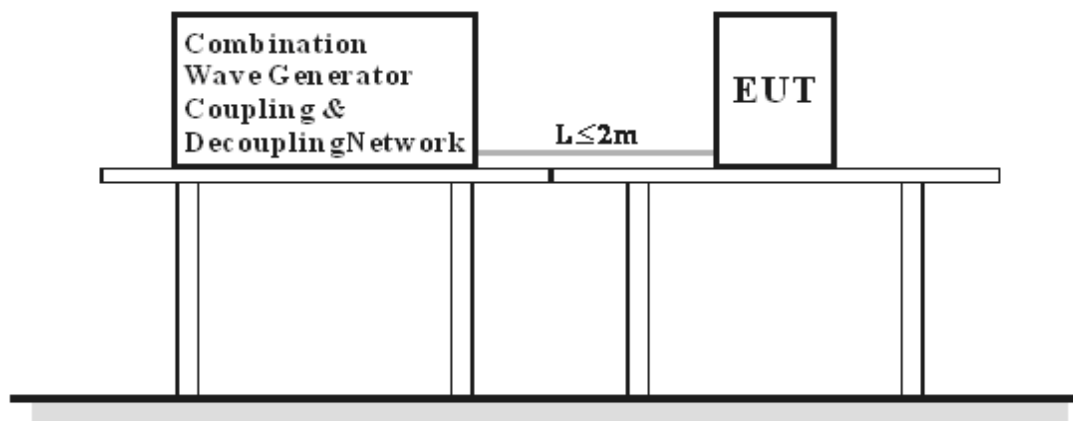

For the actual test configuration, please refer to the related item – Photographs of the Test Configuration.

6.11 Radio Frequency Common Mode (CS)

Modulation:	1kHz Sine Wave, 80%, AM Modulation
Frequency Step:	1 % of preceding frequency value
Dwell Time	3 seconds

- The EUT shall be tested within its intended operating and climatic conditions.
- An artificial hand was placed on the hand-held accessory and connected to the ground reference plane.
- One of the CDNs not used for injection was terminated with 50 ohm, providing only one return path. All other CDNs were coupled as decoupling networks.
- The frequency range shall be swept, using the signal level established during the setting process and with a disturbance signal of 80 % amplitude. The signal is modulated with a 1 kHz sine wave, pausing to adjust the RF signal level or the switch coupling devices as necessary. Where the frequency is swept incrementally, the step size shall not exceed 1 % of the preceding frequency value.
- Attempts should be made to fully exercise the EUT during testing, and to fully interrogate all exercise modes selected for susceptibility.

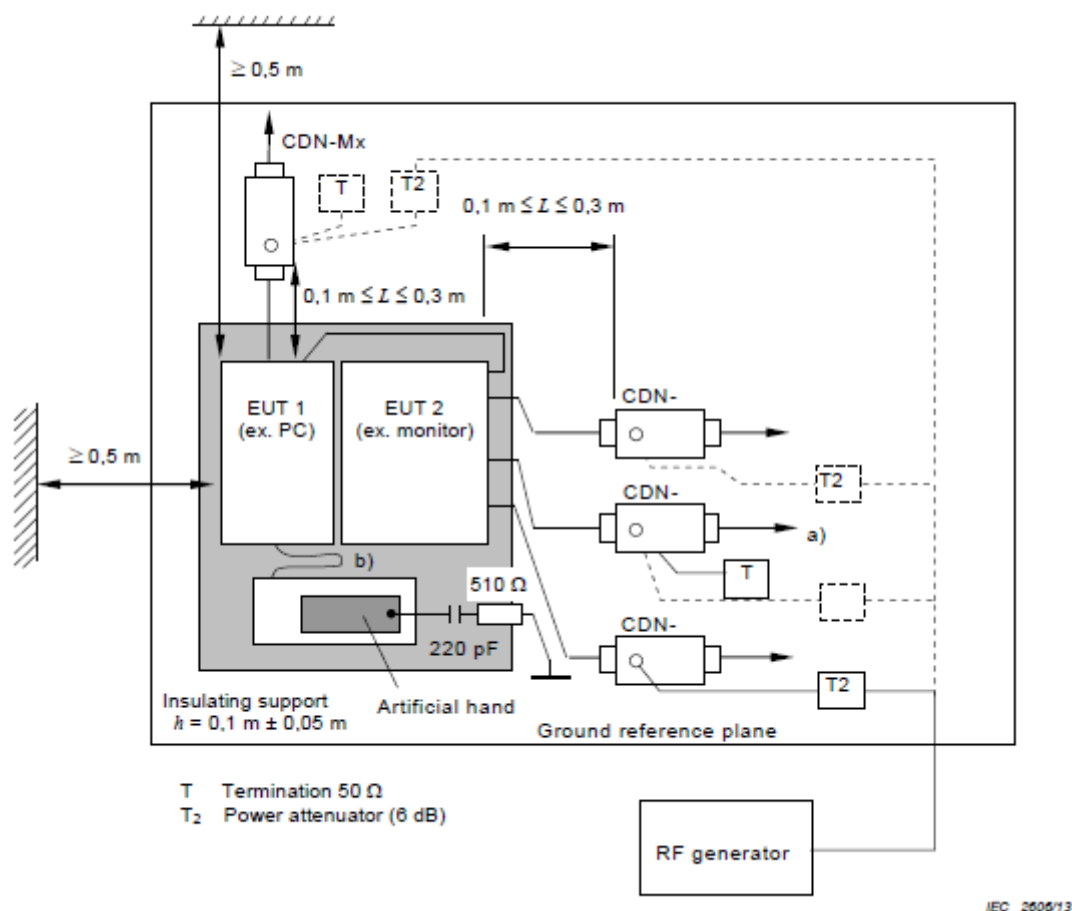

- Note:**
- The EUT clearance from any metallic obstacles shall be at least 0,5 m.
 - Interconnecting cables (≤ 1 m) belonging to the EUT shall remain on the insulating support.
- For the actual test configuration, please refer to the related item – Photographs of the Test Configuration.

Broadband impulse noise disturbances, Repetitive and Isolated (Applicable only to xDSL ports.)

- a. The EUT shall be tested within its intended operating and climatic conditions.
- b. An artificial hand was placed on the hand-held accessory and connected to the ground reference plane.
- c. One of the CDNs not used for injection was terminated with 50 ohm, providing only one return path. All other CDNs were coupled as decoupling networks.
- d. For the repetitive impulse test the disturbance shall be applied for a period of at least 2 minutes for each port under test.
- e. For the isolated impulse test a minimum of 5 isolated impulses shall be applied with an interval of at least 60 seconds between successive impulses.
- f. Attempts should be made to fully exercise the EUT during testing, and to fully interrogate all exercise modes selected for susceptibility.

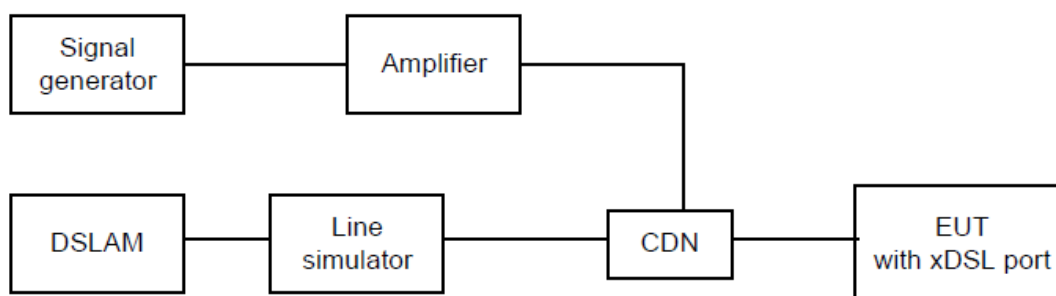

Example schematic of the broadband impulsive conducted disturbances test setup

For the actual test configuration, please refer to the related item – Photographs of the Test Configuration.

6.12 Power Frequency Magnetic Field (PFMF)

Observation Time:	1 minute
Inductance Coil:	Rectangular coil, 1 m x 1 m (L x W) or 2.6 m x 1 m (L x W)

- The equipment is configured and connected to satisfy its functional requirements.
- The power supply, input and output circuits shall be connected to the sources of power supply, control and signal.
- The cables supplied or recommended by the equipment manufacturer shall be used. 1 meter of all cables used shall be exposed to the magnetic field.

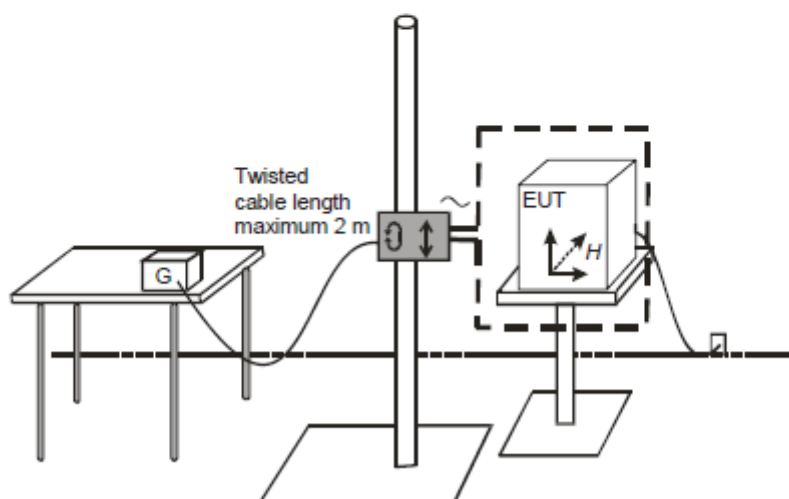
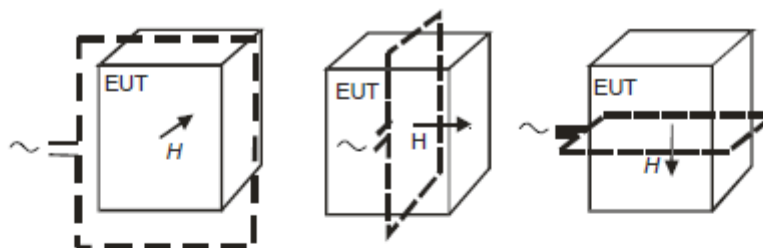

For the actual test configuration, please refer to the related item – Photographs of the Test Configuration.

6.13 Voltage Dips and Interruptions (DIP)

Interval between Event:	10 seconds
Sync Angle (degrees):	0° / 180°
Test Cycle:	3 times

- a. The test shall be performed with the EUT connected to the test generator with the shortest power supply cable as specified by the EUT manufacturer. If no cable length is specified, it shall be the shortest possible length suitable to the application of the EUT.
- b. The EUT shall be tested for each selected combination of test levels and duration with a sequence of 3 dips/interruptions with intervals of 10 s minimum (between each test event). Each representative mode of operation shall be tested. Abrupt changes in supply voltage shall occur at 0 voltage crossover point of the voltage waveform.

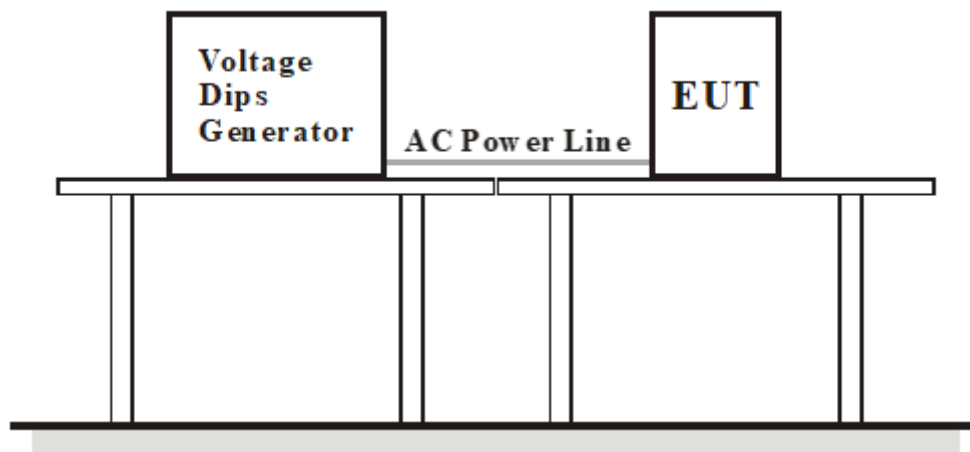

For the actual test configuration, please refer to the related item – Photographs of the Test Configuration.

7 Test Results of Test Item

7.1 Conducted Emissions from Power Ports

Mode A

Frequency Range	150 kHz ~ 30 MHz	Detector Function & Resolution Bandwidth	Quasi-Peak (QP) / Average (AV), 9kHz
Input Power	110 Vac, 60 Hz	Environmental Conditions	16°C, 83% RH
Tested by	John Liao		

Phase Of Power : Line (L)										
No	Frequency (MHz)	Correction Factor (dB)	Reading Value (dBuV)		Emission Level (dBuV)		Limit (dBuV)		Margin (dB)	
			Q.P.	AV.	Q.P.	AV.	Q.P.	AV.	Q.P.	AV.
1	0.30601	9.92	35.96	32.09	45.88	42.01	60.08	50.08	-14.20	-8.07
2	0.40588	9.92	34.23	29.32	44.15	39.24	57.73	47.73	-13.58	-8.49
3	0.60006	9.93	32.96	25.65	42.89	35.58	56.00	46.00	-13.11	-10.42
4	0.80804	9.93	32.25	25.96	42.18	35.89	56.00	46.00	-13.82	-10.11
5	1.64400	9.96	33.93	27.32	43.89	37.28	56.00	46.00	-12.11	-8.72
6	3.22412	9.99	32.35	26.30	42.34	36.29	56.00	46.00	-13.66	-9.71

Remarks:

1. Q.P. and AV. are abbreviations of quasi-peak and average individually.
2. The emission levels of other frequencies were very low against the limit.
3. Margin value = Emission level – Limit value
4. Correction factor = Insertion loss + Cable loss
5. Emission Level = Correction Factor + Reading Value

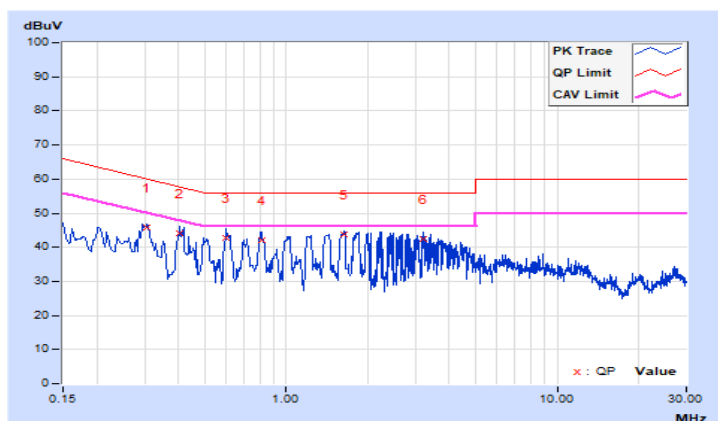

Frequency Range	150 kHz ~ 30 MHz	Detector Function & Resolution Bandwidth	Quasi-Peak (QP) / Average (AV), 9kHz
Input Power	110 Vac, 60 Hz	Environmental Conditions	16°C, 83% RH
Tested by	John Liao		

Phase Of Power : Neutral (N)										
No	Frequency (MHz)	Correction Factor (dB)	Reading Value (dBuV)		Emission Level (dBuV)		Limit (dBuV)		Margin (dB)	
			Q.P.	AV.	Q.P.	AV.	Q.P.	AV.	Q.P.	AV.
1	0.16195	9.93	36.32	27.32	46.25	37.25	65.36	55.36	-19.11	-18.11
2	0.30606	9.92	37.23	33.79	47.15	43.71	60.08	50.08	-12.93	-6.37
3	0.39789	9.92	35.52	30.52	45.44	40.44	57.90	47.90	-12.46	-7.46
4	0.69720	9.93	34.46	27.65	44.39	37.58	56.00	46.00	-11.61	-8.42
5	1.84013	9.98	30.52	26.30	40.50	36.28	56.00	46.00	-15.50	-9.72
6	11.75994	10.23	24.32	18.96	34.55	29.19	60.00	50.00	-25.45	-20.81

Remarks:

1. Q.P. and AV. are abbreviations of quasi-peak and average individually.
2. The emission levels of other frequencies were very low against the limit.
3. Margin value = Emission level – Limit value
4. Correction factor = Insertion loss + Cable loss
5. Emission Level = Correction Factor + Reading Value

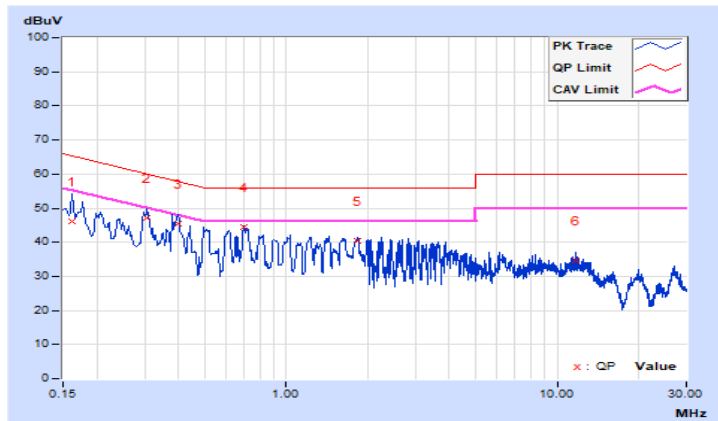

Mode B

Frequency Range	150 kHz ~ 30 MHz	Detector Function & Resolution Bandwidth	Quasi-Peak (QP) / Average (AV), 9kHz
Input Power	230 Vac, 50 Hz	Environmental Conditions	16°C, 83% RH
Tested by	John Liao		

Phase Of Power : Line (L)										
No	Frequency (MHz)	Correction Factor (dB)	Reading Value (dBuV)		Emission Level (dBuV)		Limit (dBuV)		Margin (dB)	
			Q.P.	AV.	Q.P.	AV.	Q.P.	AV.	Q.P.	AV.
1	0.19361	9.92	36.20	25.38	46.12	35.30	63.88	53.88	-17.76	-18.58
2	0.30342	9.92	36.85	32.99	46.77	42.91	60.15	50.15	-13.38	-7.24
3	0.50772	9.92	33.96	26.32	43.88	36.24	56.00	46.00	-12.12	-9.76
4	0.82386	9.93	32.52	25.36	42.45	35.29	56.00	46.00	-13.55	-10.71
5	1.59992	9.96	31.34	23.57	41.30	33.53	56.00	46.00	-14.70	-12.47
6	2.85588	9.98	30.77	18.37	40.75	28.35	56.00	46.00	-15.25	-17.65

Remarks:

1. Q.P. and AV. are abbreviations of quasi-peak and average individually.
2. The emission levels of other frequencies were very low against the limit.
3. Margin value = Emission level – Limit value
4. Correction factor = Insertion loss + Cable loss
5. Emission Level = Correction Factor + Reading Value

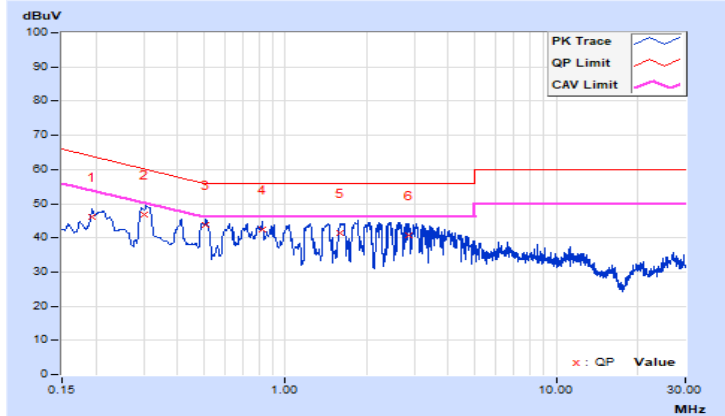

Frequency Range	150 kHz ~ 30 MHz	Detector Function & Resolution Bandwidth	Quasi-Peak (QP) / Average (AV), 9kHz
Input Power	230 Vac, 50 Hz	Environmental Conditions	16°C, 83% RH
Tested by	John Liao		

Phase Of Power : Neutral (N)										
No	Frequency (MHz)	Correction Factor (dB)	Reading Value (dBuV)		Emission Level (dBuV)		Limit (dBuV)		Margin (dB)	
			Q.P.	AV.	Q.P.	AV.	Q.P.	AV.	Q.P.	AV.
1	0.19394	9.93	36.23	25.39	46.16	35.32	63.87	53.87	-17.71	-18.55
2	0.30475	9.92	37.19	33.26	47.11	43.18	60.11	50.11	-13.00	-6.93
3	0.51188	9.93	34.75	27.66	44.68	37.59	56.00	46.00	-11.32	-8.41
4	0.73586	9.94	31.20	25.30	41.14	35.24	56.00	46.00	-14.86	-10.76
5	3.10390	10.00	28.12	21.52	38.12	31.52	56.00	46.00	-17.88	-14.48
6	11.89992	10.23	22.06	16.98	32.29	27.21	60.00	50.00	-27.71	-22.79

Remarks:

1. Q.P. and AV. are abbreviations of quasi-peak and average individually.
2. The emission levels of other frequencies were very low against the limit.
3. Margin value = Emission level – Limit value
4. Correction factor = Insertion loss + Cable loss
5. Emission Level = Correction Factor + Reading Value

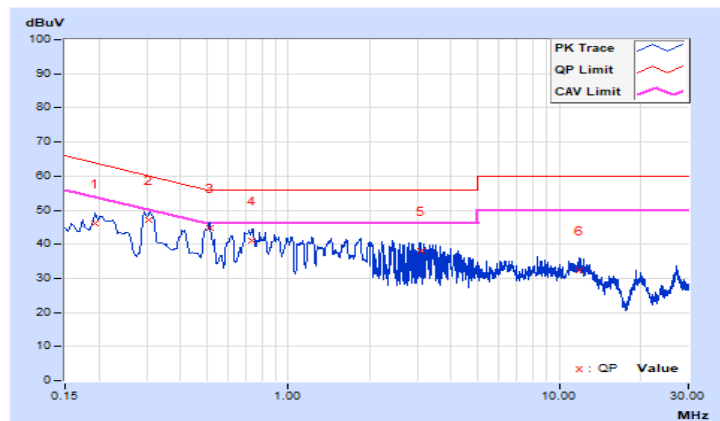

Mode C

Frequency Range	150 kHz ~ 30 MHz	Detector Function & Resolution Bandwidth	Quasi-Peak (QP) / Average (AV), 9kHz
Input Power	110 Vac, 60 Hz	Environmental Conditions	16°C, 83% RH
Tested by	John Liao		

Phase Of Power : Line (L)										
No	Frequency (MHz)	Correction Factor (dB)	Reading Value (dBuV)		Emission Level (dBuV)		Limit (dBuV)		Margin (dB)	
			Q.P.	AV.	Q.P.	AV.	Q.P.	AV.	Q.P.	AV.
1	0.30438	9.92	37.16	33.01	47.08	42.93	60.12	50.12	-13.04	-7.19
2	0.49738	9.92	34.23	27.85	44.15	37.77	56.04	46.04	-11.89	-8.27
3	0.71917	9.93	32.52	24.85	42.45	34.78	56.00	46.00	-13.55	-11.22
4	1.83194	9.96	33.02	25.16	42.98	35.12	56.00	46.00	-13.02	-10.88
5	2.85188	9.98	32.85	25.39	42.83	35.37	56.00	46.00	-13.17	-10.63
6	11.51996	10.21	22.52	18.30	32.73	28.51	60.00	50.00	-27.27	-21.49

Remarks:

1. Q.P. and AV. are abbreviations of quasi-peak and average individually.
2. The emission levels of other frequencies were very low against the limit.
3. Margin value = Emission level – Limit value
4. Correction factor = Insertion loss + Cable loss
5. Emission Level = Correction Factor + Reading Value

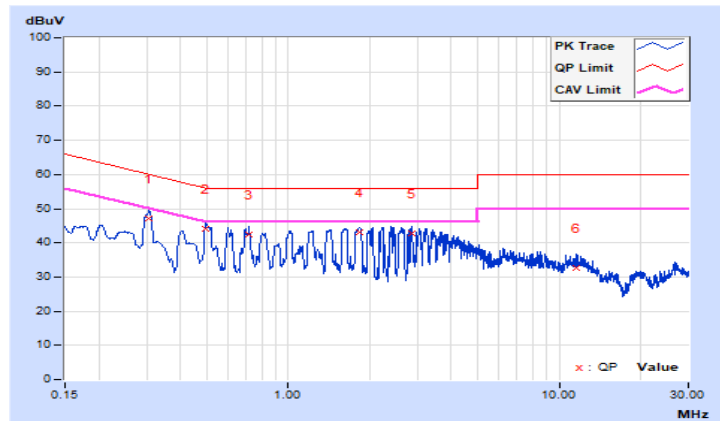

Frequency Range	150 kHz ~ 30 MHz	Detector Function & Resolution Bandwidth	Quasi-Peak (QP) / Average (AV), 9kHz
Input Power	110 Vac, 60 Hz	Environmental Conditions	16°C, 83% RH
Tested by	John Liao		

Phase Of Power : Neutral (N)										
No	Frequency (MHz)	Correction Factor (dB)	Reading Value (dBuV)		Emission Level (dBuV)		Limit (dBuV)		Margin (dB)	
			Q.P.	AV.	Q.P.	AV.	Q.P.	AV.	Q.P.	AV.
1	0.16589	9.93	35.98	27.20	45.91	37.13	65.16	55.16	-19.25	-18.03
2	0.30449	9.92	37.57	33.64	47.49	43.56	60.12	50.12	-12.63	-6.56
3	0.51036	9.93	34.20	28.30	44.13	38.23	56.00	46.00	-11.87	-7.77
4	0.71587	9.94	33.65	25.96	43.59	35.90	56.00	46.00	-12.41	-10.10
5	1.22794	9.96	32.02	24.88	41.98	34.84	56.00	46.00	-14.02	-11.16
6	8.81612	10.15	23.12	18.96	33.27	29.11	60.00	50.00	-26.73	-20.89

Remarks:

1. Q.P. and AV. are abbreviations of quasi-peak and average individually.
2. The emission levels of other frequencies were very low against the limit.
3. Margin value = Emission level – Limit value
4. Correction factor = Insertion loss + Cable loss
5. Emission Level = Correction Factor + Reading Value

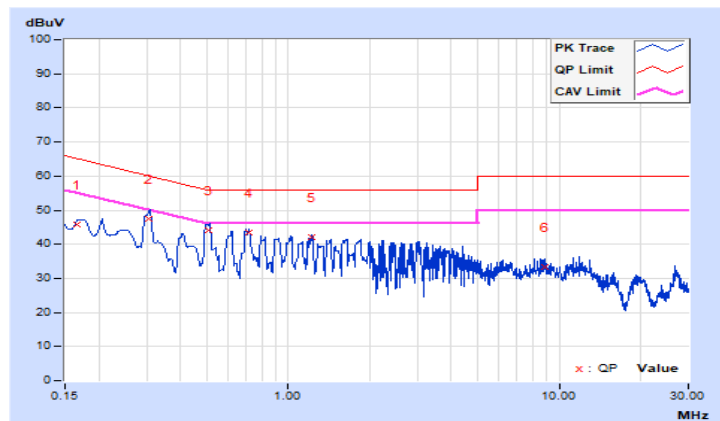

Mode D

Frequency Range	150 kHz ~ 30 MHz	Detector Function & Resolution Bandwidth	Quasi-Peak (QP) / Average (AV), 9kHz
Input Power	230 Vac, 50 Hz	Environmental Conditions	16°C, 83% RH
Tested by	John Liao		

Phase Of Power : Line (L)										
No	Frequency (MHz)	Correction Factor (dB)	Reading Value (dBuV)		Emission Level (dBuV)		Limit (dBuV)		Margin (dB)	
			Q.P.	AV.	Q.P.	AV.	Q.P.	AV.	Q.P.	AV.
1	0.20223	9.92	35.23	29.08	45.15	39.00	63.52	53.52	-18.37	-14.52
2	0.30488	9.92	35.79	30.26	45.71	40.18	60.11	50.11	-14.40	-9.93
3	0.49987	9.92	33.02	25.98	42.94	35.90	56.00	46.00	-13.06	-10.10
4	1.24388	9.95	32.93	23.08	42.88	33.03	56.00	46.00	-13.12	-12.97
5	1.84388	9.97	32.85	24.63	42.82	34.60	56.00	46.00	-13.18	-11.40
6	8.57602	10.14	23.85	17.19	33.99	27.33	60.00	50.00	-26.01	-22.67

Remarks:

1. Q.P. and AV. are abbreviations of quasi-peak and average individually.
2. The emission levels of other frequencies were very low against the limit.
3. Margin value = Emission level – Limit value
4. Correction factor = Insertion loss + Cable loss
5. Emission Level = Correction Factor + Reading Value

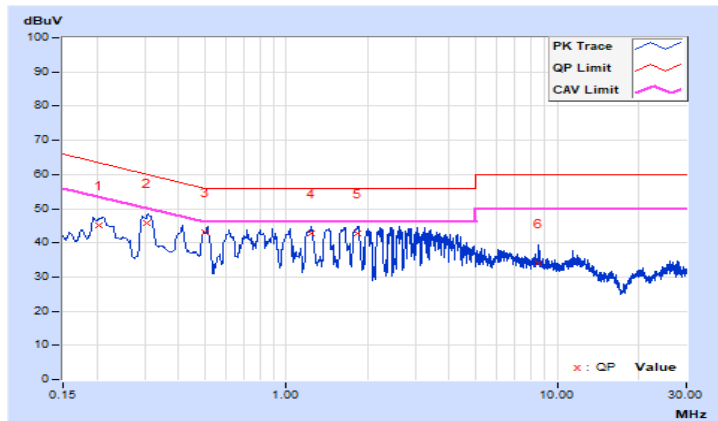

Frequency Range	150 kHz ~ 30 MHz	Detector Function & Resolution Bandwidth	Quasi-Peak (QP) / Average (AV), 9kHz
Input Power	230 Vac, 50 Hz	Environmental Conditions	16°C, 83% RH
Tested by	John Liao		

Phase Of Power : Neutral (N)										
No	Frequency (MHz)	Correction Factor (dB)	Reading Value (dBuV)		Emission Level (dBuV)		Limit (dBuV)		Margin (dB)	
			Q.P.	AV.	Q.P.	AV.	Q.P.	AV.	Q.P.	AV.
1	0.19408	9.93	35.62	25.20	45.55	35.13	63.86	53.86	-18.31	-18.73
2	0.29692	9.93	36.96	32.98	46.89	42.91	60.33	50.33	-13.44	-7.42
3	0.51068	9.93	33.89	26.35	43.82	36.28	56.00	46.00	-12.18	-9.72
4	0.72393	9.94	32.48	24.36	42.42	34.30	56.00	46.00	-13.58	-11.70
5	1.66012	9.97	28.32	21.02	38.29	30.99	56.00	46.00	-17.71	-15.01
6	11.78792	10.23	22.15	16.32	32.38	26.55	60.00	50.00	-27.62	-23.45

Remarks:

1. Q.P. and AV. are abbreviations of quasi-peak and average individually.
2. The emission levels of other frequencies were very low against the limit.
3. Margin value = Emission level – Limit value
4. Correction factor = Insertion loss + Cable loss
5. Emission Level = Correction Factor + Reading Value

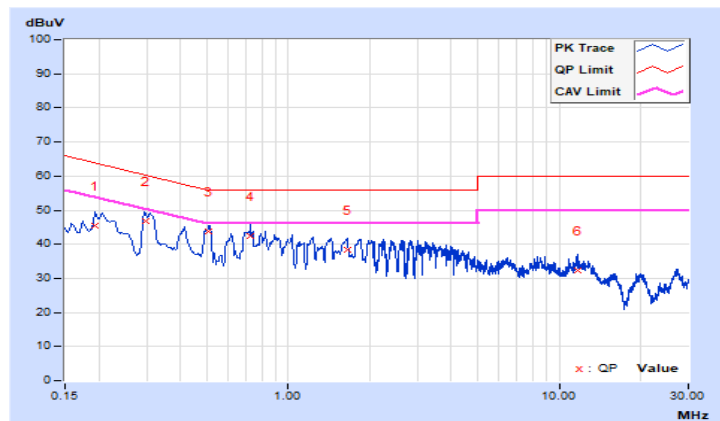

7.2 Conducted Emissions from Wired Network Ports

Mode A

Frequency Range	150 kHz ~ 30 MHz	Detector Function & Resolution Bandwidth	Quasi-Peak (QP) / Average (AV), 9kHz
Input Power	230 Vac, 50 Hz	Environmental Conditions	17°C, 83% RH
Tested by	John Liao		

No	Frequency (MHz)	Correction Factor (dB)	Reading Value (dBuV)		Emission Level (dBuV)		Limit (dBuV)		Margin (dB)	
			Q.P.	AV.	Q.P.	AV.	Q.P.	AV.	Q.P.	AV.
1	0.60396	9.35	40.23	38.30	49.58	47.65	74.00	64.00	-24.42	-16.35
2	1.25602	9.26	41.85	39.62	51.11	48.88	74.00	64.00	-22.89	-15.12
3	1.86012	9.21	42.06	38.63	51.27	47.84	74.00	64.00	-22.73	-16.16
4	3.00015	9.16	41.20	39.16	50.36	48.32	74.00	64.00	-23.64	-15.68
5	3.67612	9.15	41.85	38.23	51.00	47.38	74.00	64.00	-23.00	-16.62
6	28.02396	9.77	40.85	39.85	50.62	49.62	74.00	64.00	-23.38	-14.38

Remarks:

1. Q.P. and AV. are abbreviations of quasi-peak and average individually.
2. The emission levels of other frequencies were very low against the limit.
3. Margin value = Emission level – Limit value
4. Correction factor = Insertion loss + Cable loss
5. Emission Level = Correction Factor + Reading Value

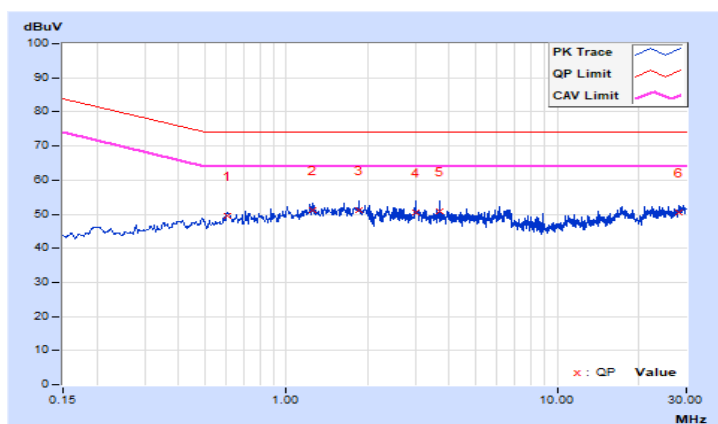

7.3 Radiated Emissions up to 1 GHz

Mode A

Frequency Range	30 MHz ~ 1 GHz	Detector Function & Resolution Bandwidth	Quasi-Peak (QP), 120 kHz
Tested By	Vincent Lin	Environmental Conditions	20°C, 67% RH

Antenna Polarity & Test Distance : Horizontal at 10 m

No	Frequency (MHz)	Emission Level (dBuV/m)	Limit (dBuV/m)	Margin (dB)	Antenna Height (m)	Table Angle (Degree)	Raw Value (dBuV)	Correction Factor (dB/m)
1	140.97	25.42 QP	30.00	-4.58	4.00 H	147	42.37	-16.95
2	208.88	25.78 QP	30.00	-4.22	3.00 H	216	45.03	-19.25
3	360.64	32.52 QP	37.00	-4.48	2.41 H	262	46.57	-14.05
4	397.31	32.54 QP	37.00	-4.46	1.85 H	276	45.65	-13.11
5	687.69	32.17 QP	37.00	-4.83	4.00 H	345	39.53	-7.36
6	749.82	32.56 QP	37.00	-4.44	1.00 H	74	38.95	-6.39
7	809.34	32.48 QP	37.00	-4.52	1.11 H	267	38.24	-5.76
8	839.75	32.02 QP	37.00	-4.98	1.00 H	215	36.98	-4.96
9	878.94	32.07 QP	37.00	-4.93	1.28 H	123	36.47	-4.40
10	977.01	32.58 QP	37.00	-4.42	1.00 H	62	35.65	-3.07

Remarks:

1. Emission Level(dBuV/m) = Raw Value(dBuV) + Correction Factor(dB/m)
2. Correction Factor(dB/m) = Antenna Factor (dB/m) + Cable Factor (dB)
– Pre-Amplifier Factor (dB)
3. The other emission levels were very low against the limit.
4. Margin value = Emission level – Limit value

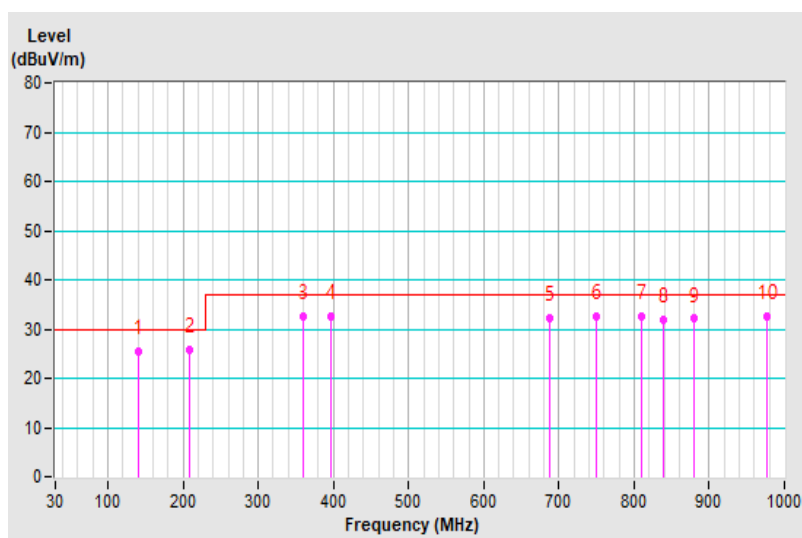

Frequency Range	30 MHz ~ 1 GHz	Detector Function & Resolution Bandwidth	Quasi-Peak (QP), 120 kHz
Tested By	Vincent Lin	Environmental Conditions	20°C, 67% RH

Antenna Polarity & Test Distance : Vertical at 10 m

No	Frequency (MHz)	Emission Level (dBuV/m)	Limit (dBuV/m)	Margin (dB)	Antenna Height (m)	Table Angle (Degree)	Raw Value (dBuV)	Correction Factor (dB/m)
1	145.48	25.42 QP	30.00	-4.58	1.00 V	346	42.03	-16.61
2	174.15	25.07 QP	30.00	-4.93	1.05 V	290	41.99	-16.92
3	208.88	25.80 QP	30.00	-4.20	1.00 V	286	45.33	-19.53
4	357.49	32.74 QP	37.00	-4.26	1.00 V	249	47.32	-14.58
5	404.49	31.44 QP	37.00	-5.56	1.00 V	352	44.88	-13.44
6	568.43	31.06 QP	37.00	-5.94	4.00 V	290	41.05	-9.99
7	636.43	31.48 QP	37.00	-5.52	3.36 V	257	39.73	-8.25
8	684.78	32.83 QP	37.00	-4.17	1.85 V	307	40.76	-7.93
9	748.41	32.56 QP	37.00	-4.44	2.78 V	146	39.61	-7.05
10	898.68	32.18 QP	37.00	-4.82	3.09 V	322	37.11	-4.93

Remarks:

1. Emission Level(dBuV/m) = Raw Value(dBuV) + Correction Factor(dB/m)
2. Correction Factor(dB/m) = Antenna Factor (dB/m) + Cable Factor (dB) – Pre-Amplifier Factor (dB)
3. The other emission levels were very low against the limit.
4. Margin value = Emission level – Limit value

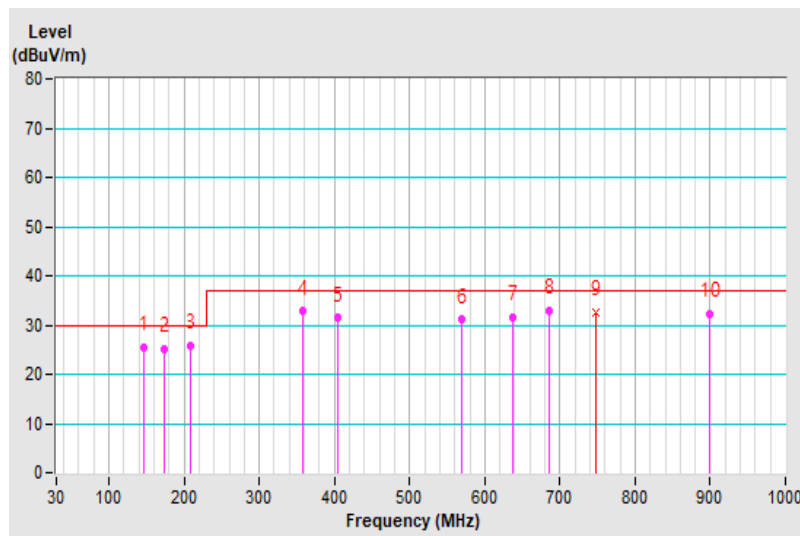



Mode B

Frequency Range	30 MHz ~ 1 GHz	Detector Function & Resolution Bandwidth	Quasi-Peak (QP), 120 kHz
Tested By	Eddie Tsai	Environmental Conditions	21°C, 70% RH

Antenna Polarity & Test Distance : Horizontal at 10 m								
No	Frequency (MHz)	Emission Level (dBuV/m)	Limit (dBuV/m)	Margin (dB)	Antenna Height (m)	Table Angle (Degree)	Raw Value (dBuV)	Correction Factor (dB/m)
1	54.83	20.05 QP	30.00	-9.95	3.89 H	105	37.32	-17.27
2	141.41	19.63 QP	30.00	-10.37	2.69 H	174	36.52	-16.89
3	208.88	23.98 QP	30.00	-6.02	2.11 H	121	43.23	-19.25
4	353.18	31.88 QP	37.00	-5.12	2.36 H	356	46.13	-14.25
5	530.50	29.04 QP	37.00	-7.96	1.78 H	278	39.56	-10.52
6	855.61	32.44 QP	37.00	-4.56	1.10 H	290	36.86	-4.42
7	957.46	31.39 QP	37.00	-5.61	3.28 H	357	34.61	-3.22

Remarks:

1. Emission Level(dBuV/m) = Raw Value(dBuV) + Correction Factor(dB/m)
2. Correction Factor(dB/m) = Antenna Factor (dB/m) + Cable Factor (dB) – Pre-Amplifier Factor (dB)
3. The other emission levels were very low against the limit.
4. Margin value = Emission level – Limit value

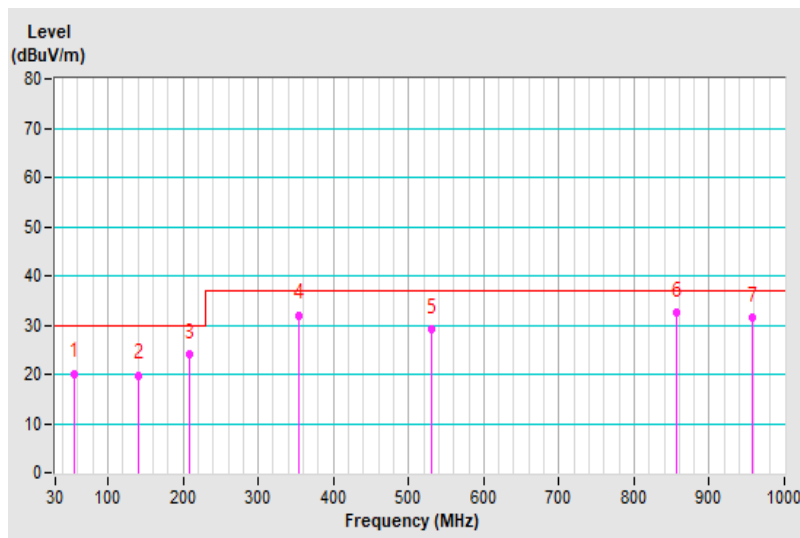

Frequency Range	30 MHz ~ 1 GHz	Detector Function & Resolution Bandwidth	Quasi-Peak (QP), 120 kHz
Tested By	Eddie Tsai	Environmental Conditions	21°C, 70% RH

Antenna Polarity & Test Distance : Vertical at 10 m

No	Frequency (MHz)	Emission Level (dBuV/m)	Limit (dBuV/m)	Margin (dB)	Antenna Height (m)	Table Angle (Degree)	Raw Value (dBuV)	Correction Factor (dB/m)
1	55.37	24.64 QP	30.00	-5.36	1.29 V	276	41.94	-17.30
2	73.02	25.41 QP	30.00	-4.59	2.34 V	50	45.52	-20.11
3	91.36	23.91 QP	30.00	-6.09	3.59 V	112	46.61	-22.70
4	178.76	23.64 QP	30.00	-6.36	1.47 V	288	41.19	-17.55
5	383.10	30.26 QP	37.00	-6.74	1.10 V	308	43.94	-13.68
6	629.88	29.83 QP	37.00	-7.17	3.22 V	291	38.13	-8.30
7	879.76	31.07 QP	37.00	-5.93	2.63 V	120	36.09	-5.02

Remarks:

1. Emission Level(dBuV/m) = Raw Value(dBuV) + Correction Factor(dB/m)
2. Correction Factor(dB/m) = Antenna Factor (dB/m) + Cable Factor (dB) – Pre-Amplifier Factor (dB)
3. The other emission levels were very low against the limit.
4. Margin value = Emission level – Limit value

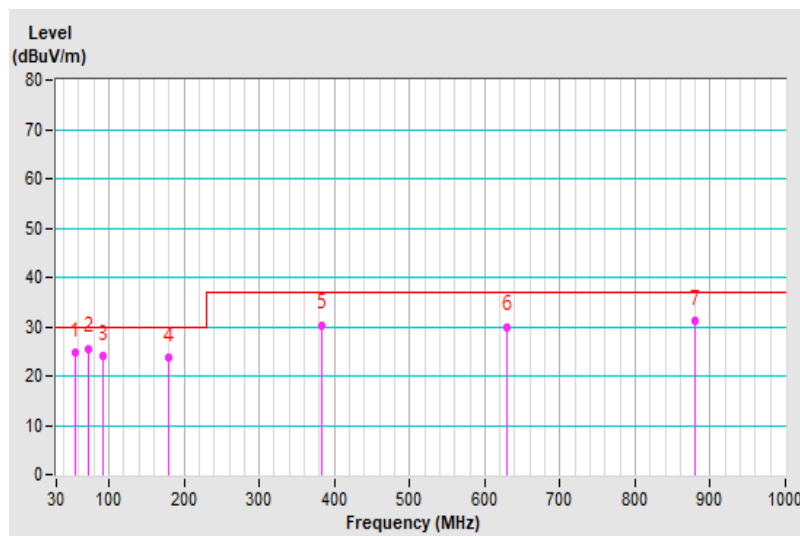

7.4 Radiated Emissions above 1 GHz

Mode A

Frequency Range	1 GHz ~ 6 GHz	Detector Function & Resolution Bandwidth	Peak (PK) / Average (AV), 1MHz
Tested By	Kobe Lu	Environmental Conditions	22°C, 77% RH

Antenna Polarity & Test Distance : Horizontal at 3 m								
No	Frequency (MHz)	Emission Level (dBuV/m)	Limit (dBuV/m)	Margin (dB)	Antenna Height (m)	Table Angle (Degree)	Raw Value (dBuV)	Correction Factor (dB/m)
1	1213.25	53.62 PK	70.00	-16.38	1.27 H	215	58.79	-5.17
2	1213.25	32.53 AV	50.00	-17.47	1.27 H	215	37.70	-5.17
3	1594.00	50.86 PK	70.00	-19.14	1.00 H	140	55.32	-4.46
4	1594.00	34.13 AV	50.00	-15.87	1.00 H	140	38.59	-4.46
5	1890.75	48.22 PK	70.00	-21.78	1.91 H	360	50.92	-2.70
6	1890.75	31.56 AV	50.00	-18.44	1.91 H	360	34.26	-2.70
7	2368.75	50.67 PK	70.00	-19.33	1.87 H	182	52.70	-2.03
8	2368.75	30.96 AV	50.00	-19.04	1.87 H	182	32.99	-2.03
9	2796.00	48.36 PK	70.00	-21.64	1.00 H	212	49.66	-1.30
10	2796.00	36.76 AV	50.00	-13.24	1.00 H	212	38.06	-1.30
11	5992.00	51.64 PK	74.00	-22.36	1.33 H	216	47.19	4.45
12	5992.00	37.79 AV	54.00	-16.21	1.33 H	216	33.34	4.45

Remarks:

- Emission Level(dBuV/m) = Raw Value(dBuV) + Correction Factor(dB/m)
- Correction Factor(dB/m) = Antenna Factor (dB/m) + Cable Factor (dB)
– Pre-Amplifier Factor (dB)
- The other emission levels were very low against the limit.
- Margin value = Emission level – Limit value

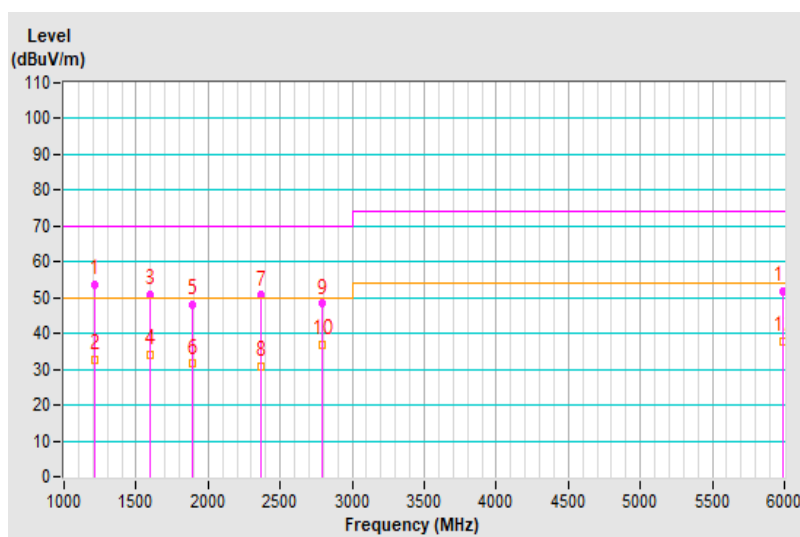

Frequency Range	1 GHz ~ 6 GHz	Detector Function & Resolution Bandwidth	Peak (PK) / Average (AV), 1MHz
Tested By	Kobe Lu	Environmental Conditions	22°C, 77% RH

Antenna Polarity & Test Distance : Vertical at 3 m								
No	Frequency (MHz)	Emission Level (dBuV/m)	Limit (dBuV/m)	Margin (dB)	Antenna Height (m)	Table Angle (Degree)	Raw Value (dBuV)	Correction Factor (dB/m)
1	1166.00	50.35 PK	70.00	-19.65	1.32 V	228	55.67	-5.32
2	1166.00	29.83 AV	50.00	-20.17	1.32 V	228	35.15	-5.32
3	1950.00	47.00 PK	70.00	-23.00	1.00 V	360	49.67	-2.67
4	1950.00	30.13 AV	50.00	-19.87	1.00 V	360	32.80	-2.67
5	2154.00	48.08 PK	70.00	-21.92	1.92 V	268	50.58	-2.50
6	2154.00	29.94 AV	50.00	-20.06	1.92 V	268	32.44	-2.50
7	2346.25	51.22 PK	70.00	-18.78	1.99 V	156	53.23	-2.01
8	2346.25	30.11 AV	50.00	-19.89	1.99 V	156	32.12	-2.01
9	2550.25	47.90 PK	70.00	-22.10	1.00 V	152	49.92	-2.02
10	2550.25	32.49 AV	50.00	-17.51	1.00 V	152	34.51	-2.02
11	2748.25	47.94 PK	70.00	-22.06	1.00 V	354	49.51	-1.57
12	2748.25	32.88 AV	50.00	-17.12	1.00 V	354	34.45	-1.57
13	2999.96	52.42 PK	70.00	-17.58	1.57 V	332	52.40	0.02
14	2999.96	35.69 AV	50.00	-14.31	1.57 V	332	35.67	0.02
15	5989.50	57.53 PK	74.00	-16.47	1.00 V	211	53.09	4.44
16	5989.50	38.34 AV	54.00	-15.66	1.00 V	211	33.90	4.44

Remarks:

1. Emission Level(dBuV/m) = Raw Value(dBuV) + Correction Factor(dB/m)
2. Correction Factor(dB/m) = Antenna Factor (dB/m) + Cable Factor (dB) – Pre-Amplifier Factor (dB)
3. The other emission levels were very low against the limit.
4. Margin value = Emission level – Limit value

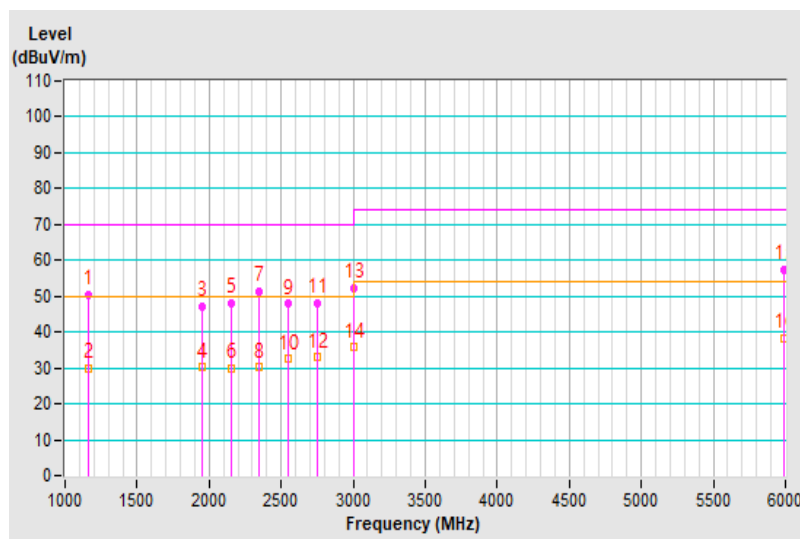

Mode B

Frequency Range	1 GHz ~ 6 GHz	Detector Function & Resolution Bandwidth	Peak (PK) / Average (AV), 1MHz
Tested By	Kobe Lu	Environmental Conditions	22°C, 77% RH

Antenna Polarity & Test Distance : Horizontal at 3 m								
No	Frequency (MHz)	Emission Level (dBuV/m)	Limit (dBuV/m)	Margin (dB)	Antenna Height (m)	Table Angle (Degree)	Raw Value (dBuV)	Correction Factor (dB/m)
1	1213.50	53.41 PK	70.00	-16.59	1.57 H	213	58.58	-5.17
2	1213.50	32.57 AV	50.00	-17.43	1.57 H	212	37.74	-5.17
3	1595.75	51.66 PK	70.00	-18.34	1.00 H	220	56.12	-4.46
4	1595.75	35.49 AV	50.00	-14.51	1.00 H	220	39.95	-4.46
5	1975.75	49.55 PK	70.00	-20.45	1.65 H	360	52.10	-2.55
6	1975.75	31.22 AV	50.00	-18.78	1.65 H	360	33.77	-2.55
7	2369.75	49.41 PK	70.00	-20.59	1.24 H	191	51.44	-2.03
8	2369.75	31.05 AV	50.00	-18.95	1.24 H	191	33.08	-2.03
9	2550.25	49.55 PK	70.00	-20.45	1.28 H	2	51.57	-2.02
10	2550.25	32.36 AV	50.00	-17.64	1.28 H	2	34.38	-2.02
11	5997.00	51.54 PK	74.00	-22.46	1.00 H	212	47.09	4.45
12	5997.00	37.22 AV	54.00	-16.78	1.00 H	212	32.77	4.45

Remarks:

1. Emission Level(dBuV/m) = Raw Value(dBuV) + Correction Factor(dB/m)
2. Correction Factor(dB/m) = Antenna Factor (dB/m) + Cable Factor (dB)
– Pre-Amplifier Factor (dB)
3. The other emission levels were very low against the limit.
4. Margin value = Emission level – Limit value

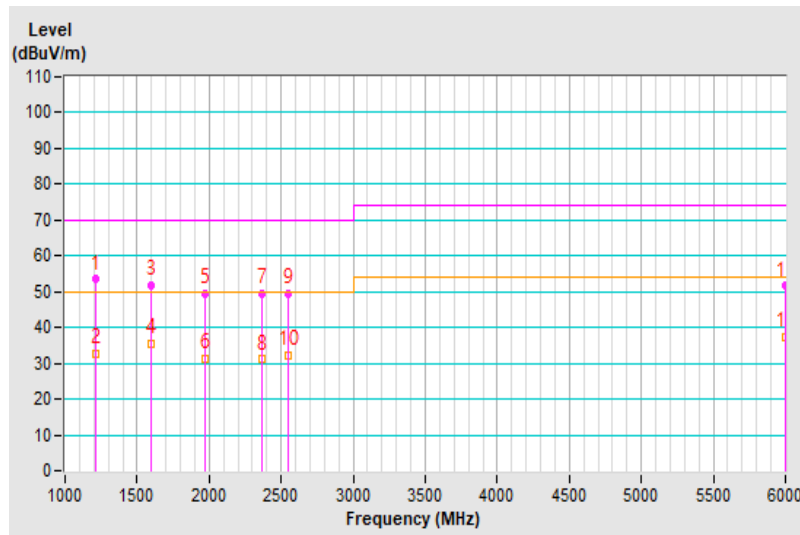

Frequency Range	1 GHz ~ 6 GHz	Detector Function & Resolution Bandwidth	Peak (PK) / Average (AV), 1MHz
Tested By	Kobe Lu	Environmental Conditions	22°C, 77% RH

Antenna Polarity & Test Distance : Vertical at 3 m

No	Frequency (MHz)	Emission Level (dBuV/m)	Limit (dBuV/m)	Margin (dB)	Antenna Height (m)	Table Angle (Degree)	Raw Value (dBuV)	Correction Factor (dB/m)
1	1185.00	47.51 PK	70.00	-22.49	1.00 V	224	52.71	-5.20
2	1185.00	29.61 AV	50.00	-20.39	1.00 V	224	34.81	-5.20
3	1949.50	48.48 PK	70.00	-21.52	1.26 V	305	51.16	-2.68
4	1949.50	31.23 AV	50.00	-18.77	1.26 V	305	33.91	-2.68
5	2189.00	48.55 PK	70.00	-21.45	1.36 V	76	51.15	-2.60
6	2189.00	30.35 AV	50.00	-19.65	1.36 V	76	32.95	-2.60
7	2389.50	50.95 PK	70.00	-19.05	1.00 V	224	53.03	-2.08
8	2389.50	30.37 AV	50.00	-19.63	1.00 V	224	32.45	-2.08
9	2550.25	50.76 PK	70.00	-19.24	1.39 V	152	52.78	-2.02
10	2550.25	33.26 AV	50.00	-16.74	1.39 V	152	35.28	-2.02
11	5996.25	54.64 PK	74.00	-19.36	1.00 V	210	50.19	4.45
12	5996.25	38.33 AV	54.00	-15.67	1.00 V	210	33.88	4.45

Remarks:

1. Emission Level(dBuV/m) = Raw Value(dBuV) + Correction Factor(dB/m)
2. Correction Factor(dB/m) = Antenna Factor (dB/m) + Cable Factor (dB) – Pre-Amplifier Factor (dB)
3. The other emission levels were very low against the limit.
4. Margin value = Emission level – Limit value

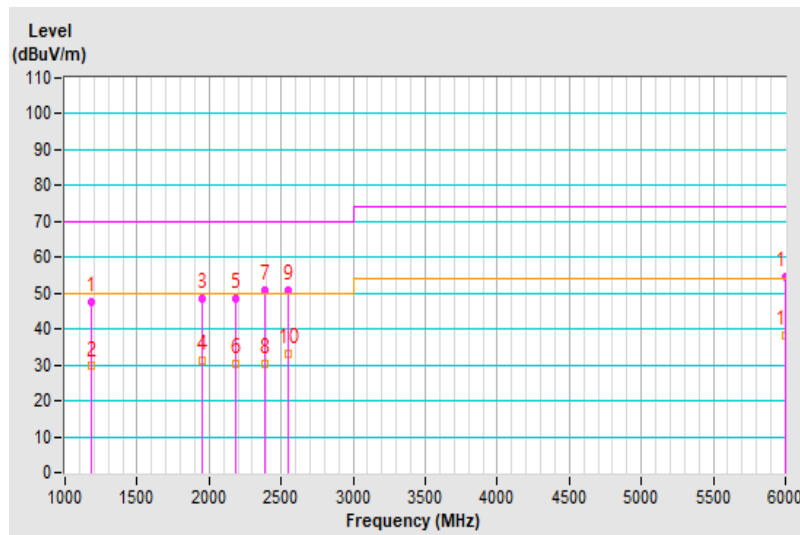

7.5 Harmonic Current Measurement

Mode A

Test Duration	5 min	Fundamental Voltage / Ampere	230.64 Vrms / 0.518 Arms
Power Consumption	106 W	Power Frequency	49.99 Hz
Power Factor	0.991	Environmental Conditions	20°C, 71% RH
Tested By	Chiming Li		

Harm#	Harms (avg) (A)	100% Limit (A)	Harms (max) (A)	150% Limit (A)
1	0.460	-	0.902	-
3	0.015	0.360	0.016	0.541
5	0.017	0.201	0.017	0.302
7	0.012	0.106	0.012	0.159
9	0.011	0.053	0.011	0.079
11	0.008	0.037	0.009	0.056
13	0.007	0.032	0.007	0.048
15	0.004	0.028	0.004	0.041
17	0.003	0.024	0.003	0.037
19	0.001	0.022	0.002	0.032
21	0.001	0.019	0.001	0.029
23	0.002	0.018	0.002	0.027
25	0.002	0.016	0.003	0.024
27	0.003	0.015	0.003	0.023
29	0.002	0.014	0.002	0.021
31	0.001	0.013	0.002	0.020
33	0.001	0.012	0.002	0.018
35	0.001	0.012	0.001	0.017
37	0.001	0.011	0.002	0.017
39	0.002	0.010	0.002	0.016

Note: Dynamic limits were applied for this test. The highest harmonics values in the above table may not occur at the same window as the maximum harmonics/limit ratio.

Mode B

Test Duration	5 min	Fundamental Voltage / Ampere	230.67 Vrms / 0.256 Arms
Power Consumption	55.3 W	Power Frequency	50 Hz
Power Factor	0.961	Environmental Conditions	20°C, 71% RH
Tested By	Chiming Li		

Notes:

- Limits are not specified for equipment with a rated power of 75W or less (other than lighting equipment).
- According to EN 61000-3-2 the manufacturer shall specify the power of the apparatus. This value shall be used for establishing limits. The specified power shall be within +/-10% of the measured power.

7.6 Voltage Fluctuations and Flicker Measurement

Mode A

Observation (Tp)	10 min		
Input Power	230 Vac, 50 Hz	Environmental Conditions	20°C, 71% RH
Tested By	Chiming Li		

Test Parameter	Measurement Value	Limit	Remarks
P_{st}	0.226	1.00	Pass
P_{lt}	0.099	0.65	Pass
T_{max} (ms)	0.000	500	Pass
d_{max} (%)	0.000	4.00	Pass
d_c (%)	0.000	3.30	Pass

Notes:

- a. P_{st} means short-term flicker indicator.
- b. P_{lt} means long-term flicker indicator.
- c. T_{max} means accumulated time value of $d(t)$ with a deviation exceeding 3.3 %.
- d. d_{max} means maximum relative voltage change.
- e. d_c means maximum relative steady-state voltage change.

7.7 Electrostatic Discharges (ESD)

Mode A

For EN 55035

Input Power	AC 230V / 50Hz	Environmental conditions	24 °C, 49 % RH 1008 mbar
Tested by	Chiming Li		

Test Results of Direct Application

Discharge Level (kV)	Polarity (+/-)	Test Point	Contact Discharge	Air Discharge	Performance Criteria
2,4	+/-	3,4,7,9,12	Note 1	---	A
2,4	+/-	1,2,5,6,8,10,11,13-19	---	Note 1	A
8	+/-	2,5,6,10,11,13-19	---	Note 1	A
8	+/-	1	---	Note 2	B
8	+/-	8	---	Note 3	B

Description of test points of direct application: Please refer to following page for representative mark only.

Test Results of Indirect Application

Discharge Level (kV)	Polarity (+/-)	Test Point	Horizontal Coupling Plane	Vertical Coupling Plane	Performance Criteria
2,4	+/-	Four Side	Note 1	Note 1	A

Description of test points of indirect application:

1. Front side 2. Rear side 3. Right side 4. Left side

Please refer to the attached page for description of test points.

Notes:

1. The EUT is operated normal during the test.
2. There are horizontal bar on screen during the test, but auto recover after the test.
3. The EUT LAN ping time out 1-2 second (link ok) during the test, but auto recover after the test.

Description of test point

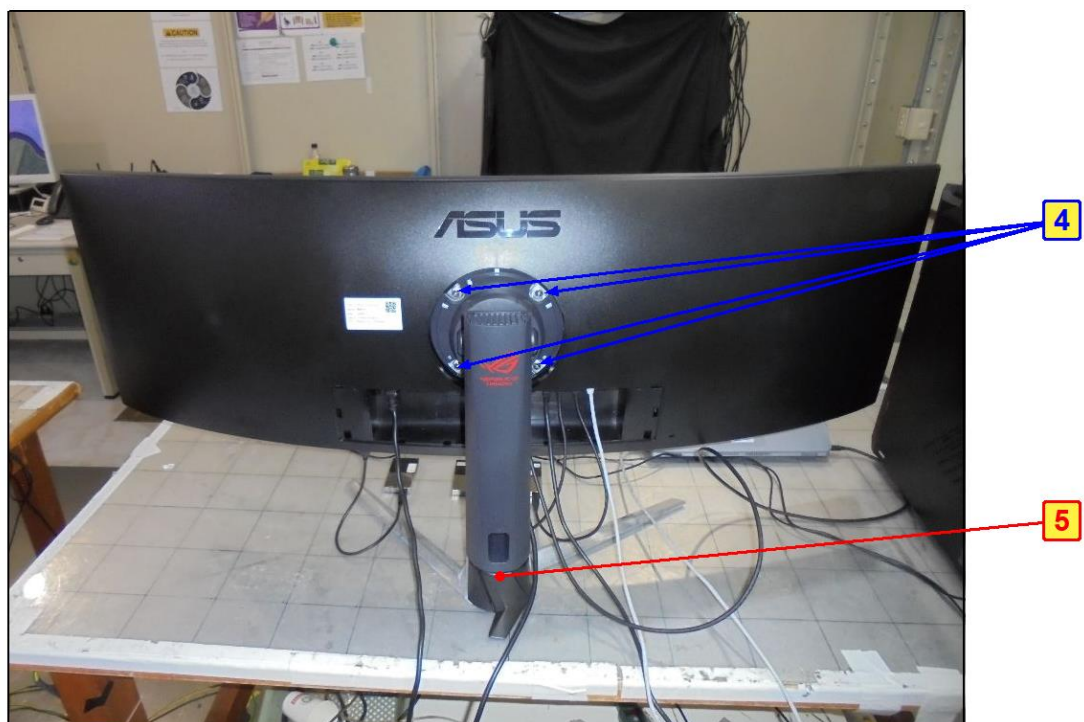
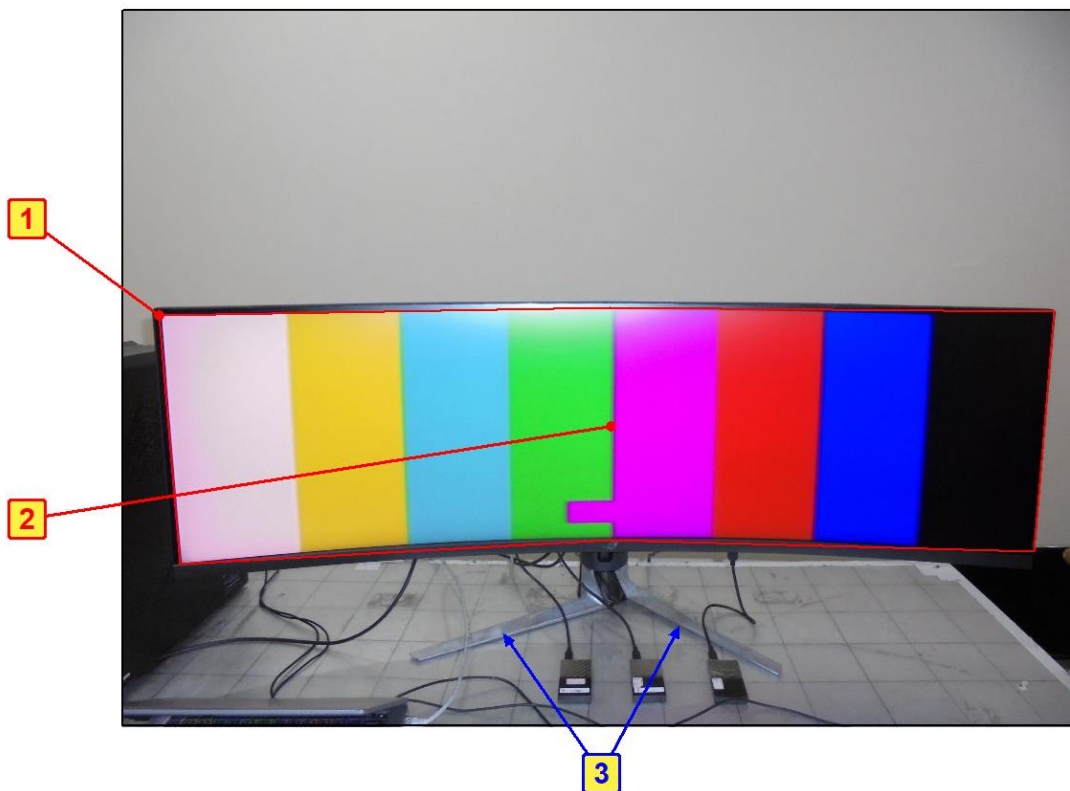

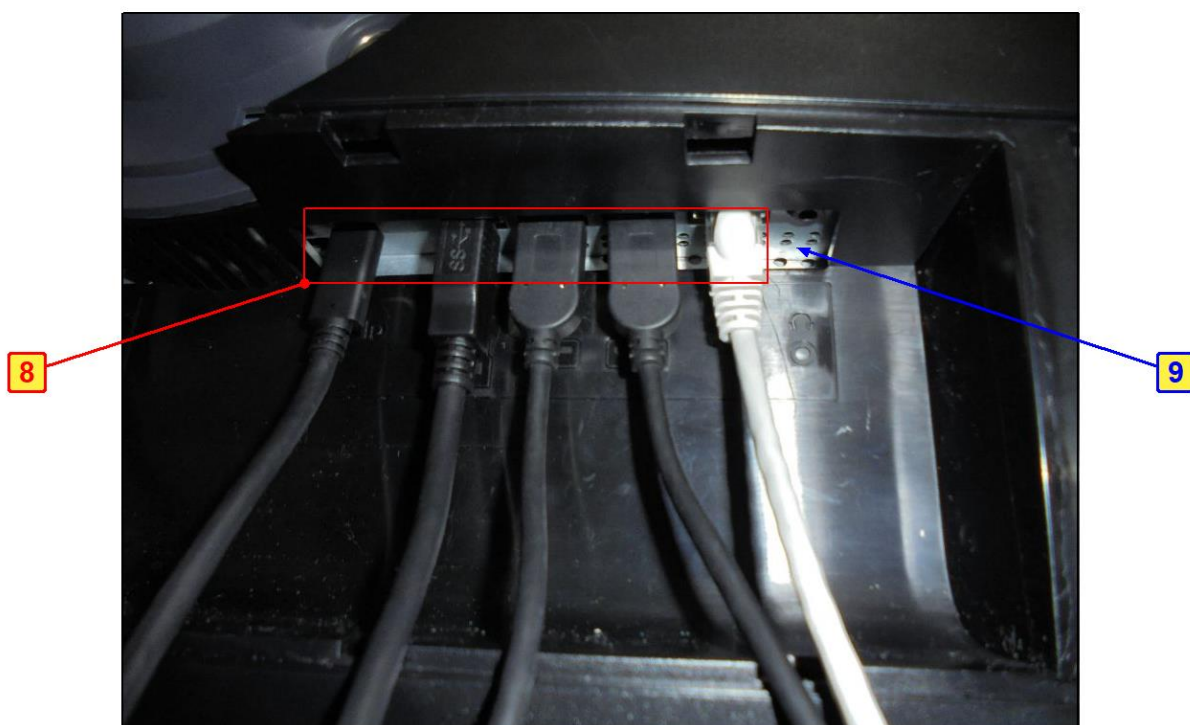

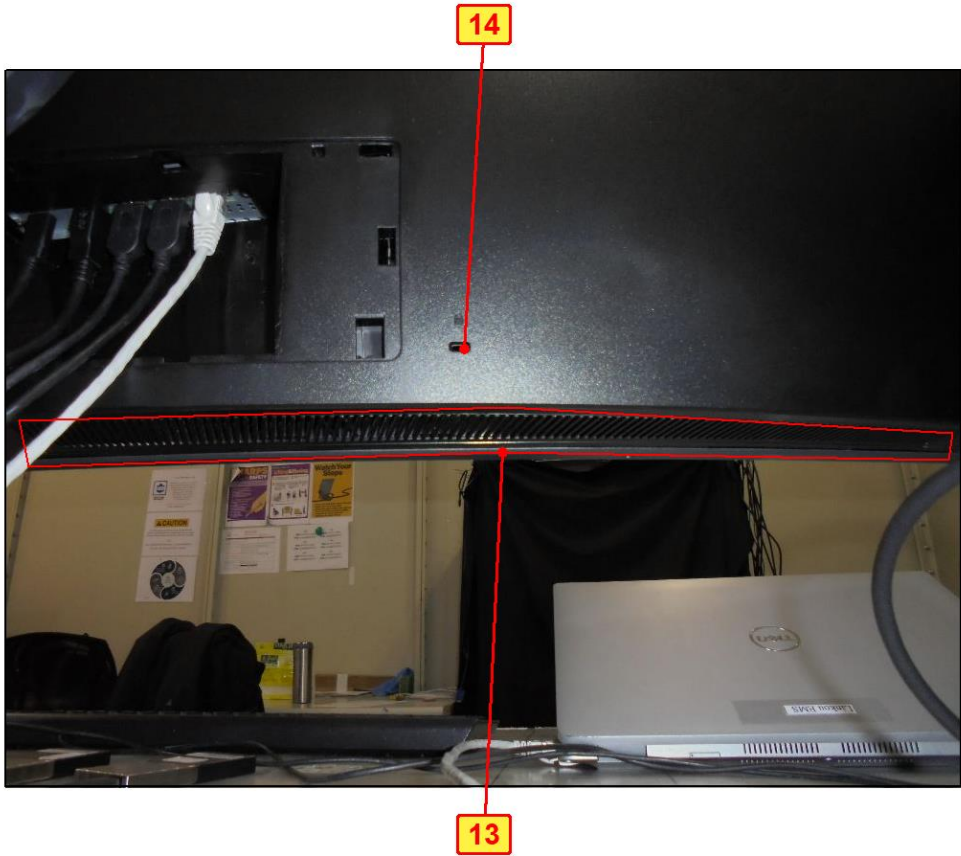
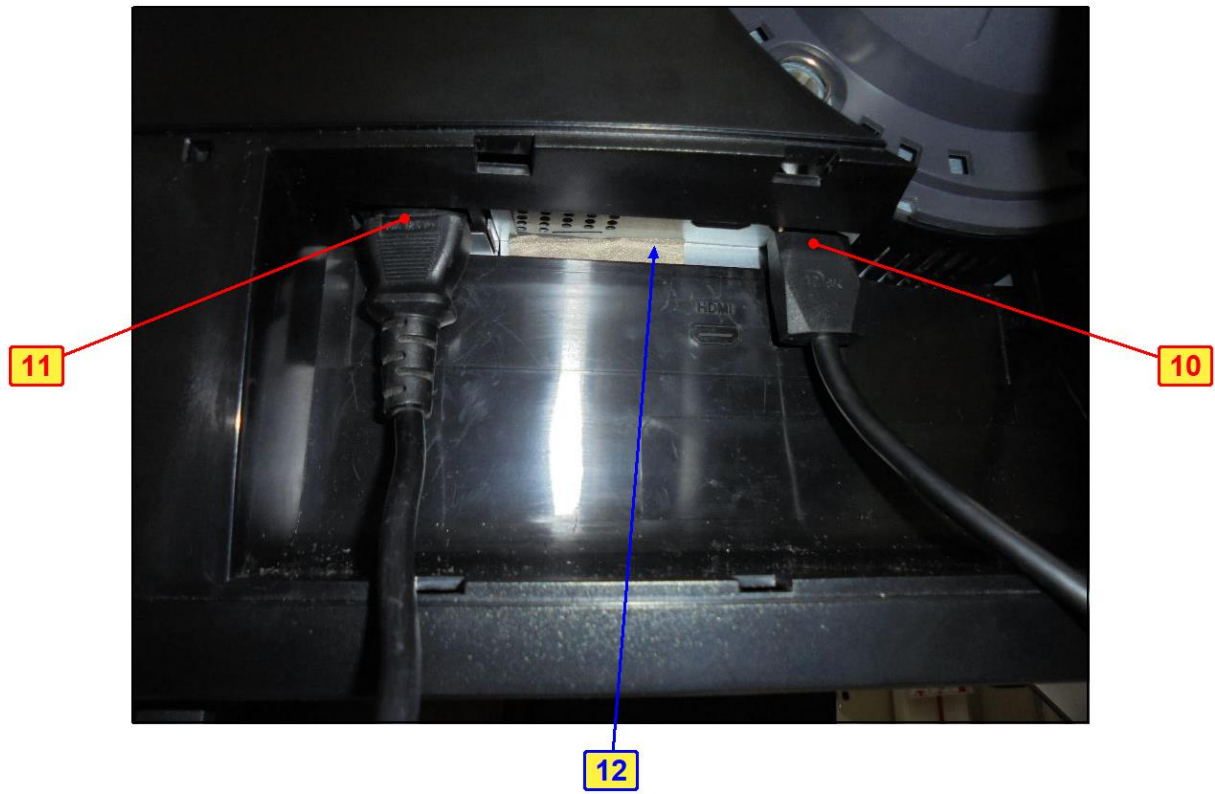

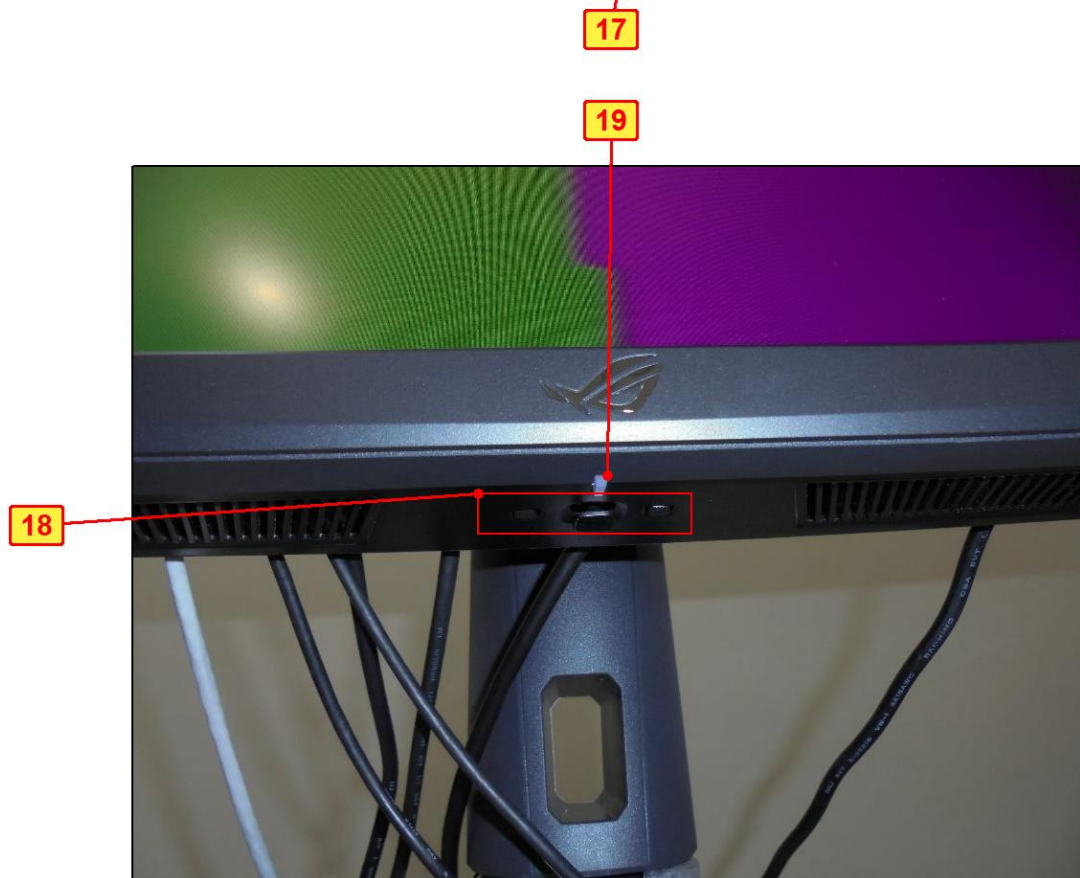
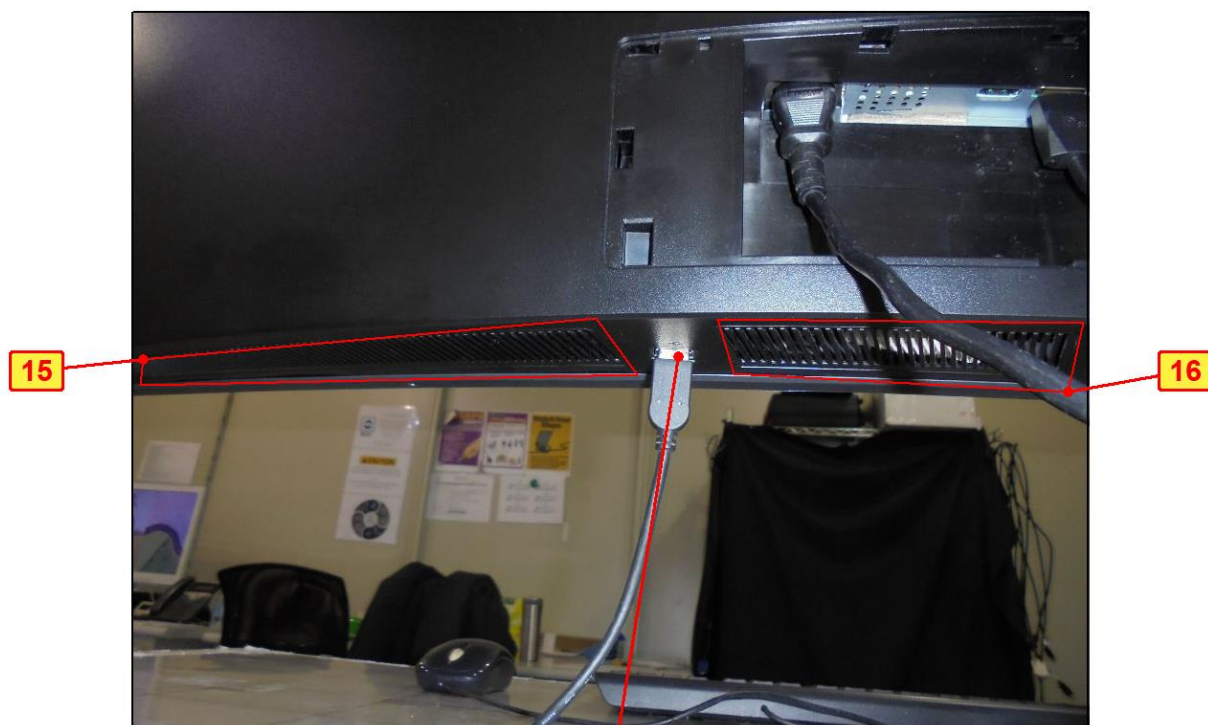

7.8 Radio Frequency Electromagnetic Field (RS)

Mode A

For EN 55035

Input Power	AC 230V / 50Hz	Environmental conditions	22 °C, 70 % RH 1010 mbar
Tested by	Chiming Li		

Frequency (MHz)	Polarity	Azimuth(°)	Applied Field Strength		Observation	Performance Criteria
			(V/m)	Modulation		
80 - 1000	V&H	0, 90, 180, 270	3	80% AM (1kHz)	Note 1	A
1800, 2600, 3500, 5000	V&H	0, 90, 180, 270	3	80% AM (1kHz)	Note 1	A
80 - 1000	V&H	0, 90, 180, 270	3	80% AM (1kHz)	Note 2, Note 3	A
1800, 2600, 3500, 5000	V&H	0, 90, 180, 270	3	80% AM (1kHz)	Note 2, Note 3	A

Notes:

1. The EUT is operated normal during the test.
2. Audio Out Function (Speaker out) Acoustic Reference level Pass.
3. Audio Out Function (Ear Phone out) Electrical Reference level Pass.

7.9 Fast Transients Common Mode (EFT)

Mode A

For EN 55035

Input Power	AC 230V / 50Hz	Environmental conditions	21 °C, 72 % RH 1008 mbar
Tested by	Chiming Li		

Input AC power port				
Voltage (kV)	Test Point	Polarity (+/-)	Observation	Performance Criteria
1	L	+/-	Note	A
1	N	+/-	Note	A
1	PE	+/-	Note	A
1	L-N-PE	+/-	Note	A

Wired network and signal/ control port				
Voltage (kV)	Test Point	Polarity (+/-)	Observation	Performance Criteria
0.5	LAN	+/-	Note	A

Note: The EUT is operated normal during the test.

7.10 Surges

Mode A

For EN 55035

Input Power	AC 230V / 50Hz	Environmental conditions	20 °C, 71 % RH 1008 mbar
Tested by	Chiming Li		

Input AC power port					
Voltage (kV)	Test Point	Azimuth(°)	Polarity (+/-)	Observation	Performance Criteria
0.5,1	L-N	90, 270	+/-	Note	A
0.5,1,2	L-PE	90, 270	+/-	Note	A
0.5,1,2	N-PE	90, 270	+/-	Note	A

Note: The EUT is operated normal during the test.

7.11 Radio Frequency Common Mode (CS)

Mode A

For EN 55035

Input Power	AC 230V / 50Hz	Environmental conditions	20 °C, 73 % RH 1008 mbar
Tested by	Michael Cheng		

Input AC power port							
Frequency (MHz)	Level (V rms)	Modulation	Tested Line	Injection Method	Return Path	Observation	Performance Criteria
0.15 – 10	3	80% AM (1kHz)	AC power	CDN-M3	CDN-T8	Note 1	A
10 – 30	3 ~ 1	80% AM (1kHz)	AC power	CDN-M3	CDN-T8	Note 1	A
30 – 80	1	80% AM (1kHz)	AC power	CDN-M3	CDN-T8	Note 1	A
0.15 – 10	3	80% AM (1kHz)	AC power	CDN-M3	CDN-T8	Note 2,Note 3	A
10 – 30	3 ~ 1	80% AM (1kHz)	AC power	CDN-M3	CDN-T8	Note 2,Note 3	A
30 – 80	1	80% AM (1kHz)	AC power	CDN-M3	CDN-T8	Note 2,Note 3	A

Wired network and signal/ control port							
Frequency (MHz)	Level (V rms)	Modulation	Tested Line	Injection Method	Return Path	Observation	Performance Criteria
0.15 – 10	3	80% AM (1kHz)	LAN	CDN-T8	CDN-M3	Note 1	A
10 – 30	3 ~ 1	80% AM (1kHz)	LAN	CDN-T8	CDN-M3	Note 1	A
30 – 80	1	80% AM (1kHz)	LAN	CDN-T8	CDN-M3	Note 1	A
0.15 – 10	3	80% AM (1kHz)	LAN	CDN-T8	CDN-M3	Note 2,Note 3	A
10 – 30	3 ~ 1	80% AM (1kHz)	LAN	CDN-T8	CDN-M3	Note 2,Note 3	A
30 – 80	1	80% AM (1kHz)	LAN	CDN-T8	CDN-M3	Note 2,Note 3	A

Notes:

1. The EUT is operated normal during the test.
2. Audio Out Function (Speaker out) Acoustic Reference level Pass.
3. Audio Out Function (Ear Phone out) Electrical Reference level Pass.

7.12 Power Frequency Magnetic Field (PFMF)

Mode A

For EN 55035

Input Power	AC 230V / 50Hz	Environmental conditions	22 °C, 70 % RH 1008 mbar
Tested by	Chiming Li		

Application	Frequency (Hz)	Field Strength (A/m)	Observation	Performance Criteria
X - Axis	50	1	Note	A
Y - Axis	50	1	Note	A
Z - Axis	50	1	Note	A

Note: The EUT is operated normal during the test.

7.13 Voltage Dips and Interruptions (DIP)

Mode A

For EN 55035

Input Power	AC 230V / 50Hz	Environmental conditions	20 °C, 71 % RH 1008 mbar
Tested by	Chiming Li		

Input Power for testing: <u>230Vac, 50 Hz</u> (Nominal input Voltage)					
Voltage Residual(%)	Duration (cycle)	Interval (sec)	Times	Observation	Performance Criteria
< 5	0.5	10	3	Note 1	A
70	25	10	3	Note 1	A
< 5	250	10	3	Note 2	C

Input Power for testing: <u>240Vac, 50 Hz</u> (Maximum rated input voltage)					
Voltage Residual(%)	Duration (cycle)	Interval (sec)	Times	Observation	Performance Criteria
< 5	0.5	10	3	Note 1	A
70	25	10	3	Note 1	A
< 5	250	10	3	Note 2	C

Input Power for testing: <u>100Vac, 50 Hz</u> (Minimum rated input voltage)					
Voltage Residual(%)	Duration (cycle)	Interval (sec)	Times	Observation	Performance Criteria
< 5	0.5	10	3	Note 1	A
70	25	10	3	Note 1	A
< 5	250	10	3	Note 2	C

Notes:

1. The EUT is operated normal during the test.
2. The EUT appears a "reboot" phenomena during the test, need manual recoverable after the test.

8 Pictures of Test Arrangements

8.1 Conducted Emissions from Power Ports

Mode A & Mode B



Mode C & Mode D



8.2 Conducted Emissions from Wired Network Ports

Mode A



8.3 Radiated Emissions up to 1 GHz

Mode A



Mode B

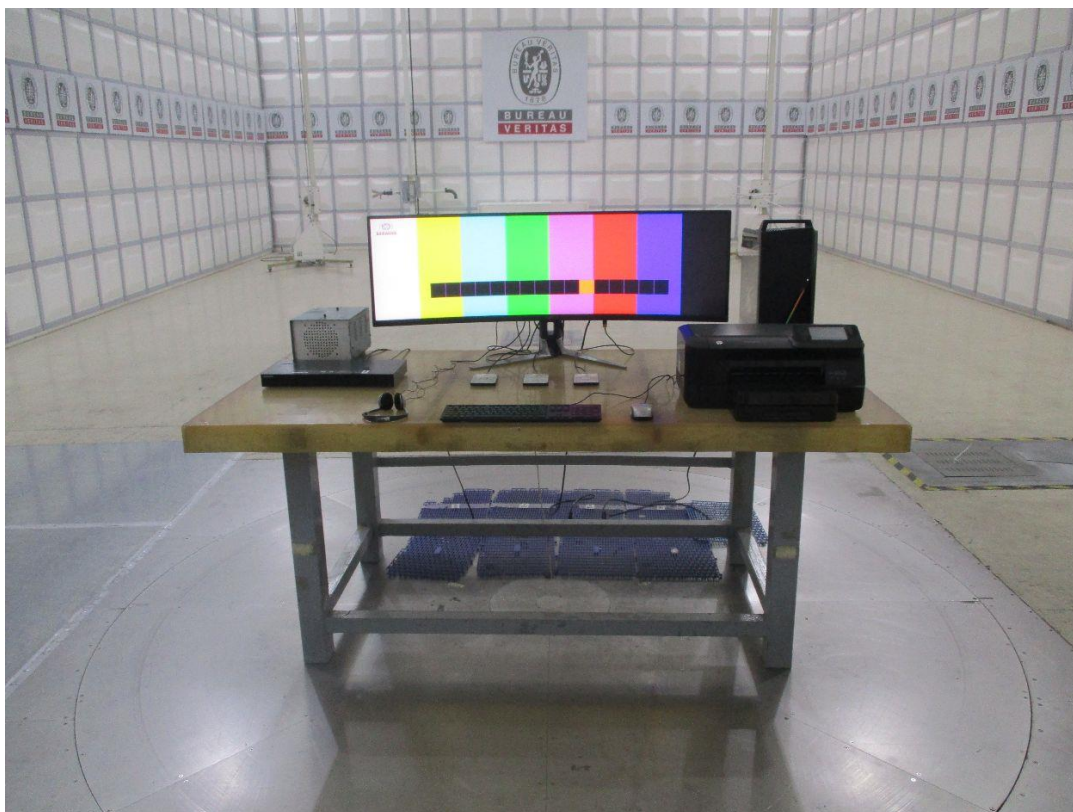

8.4 Radiated Emissions above 1 GHz

Mode A

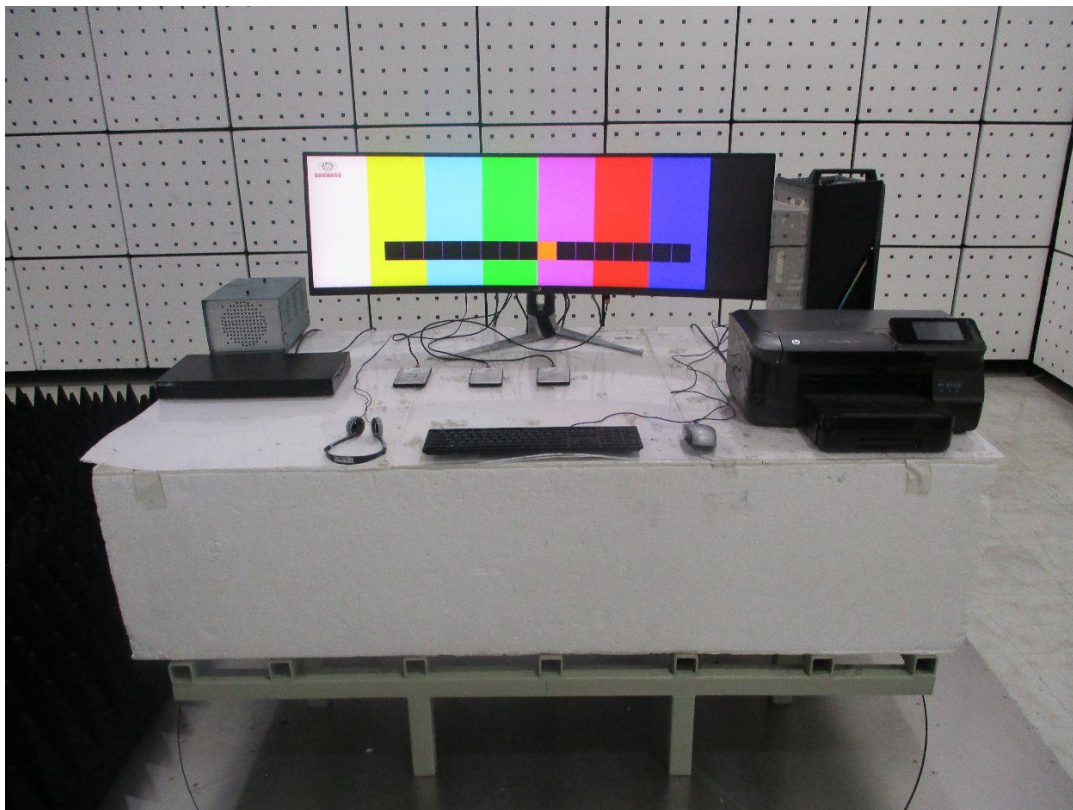

Mode B



8.5 Harmonic Current Measurement

Mode A

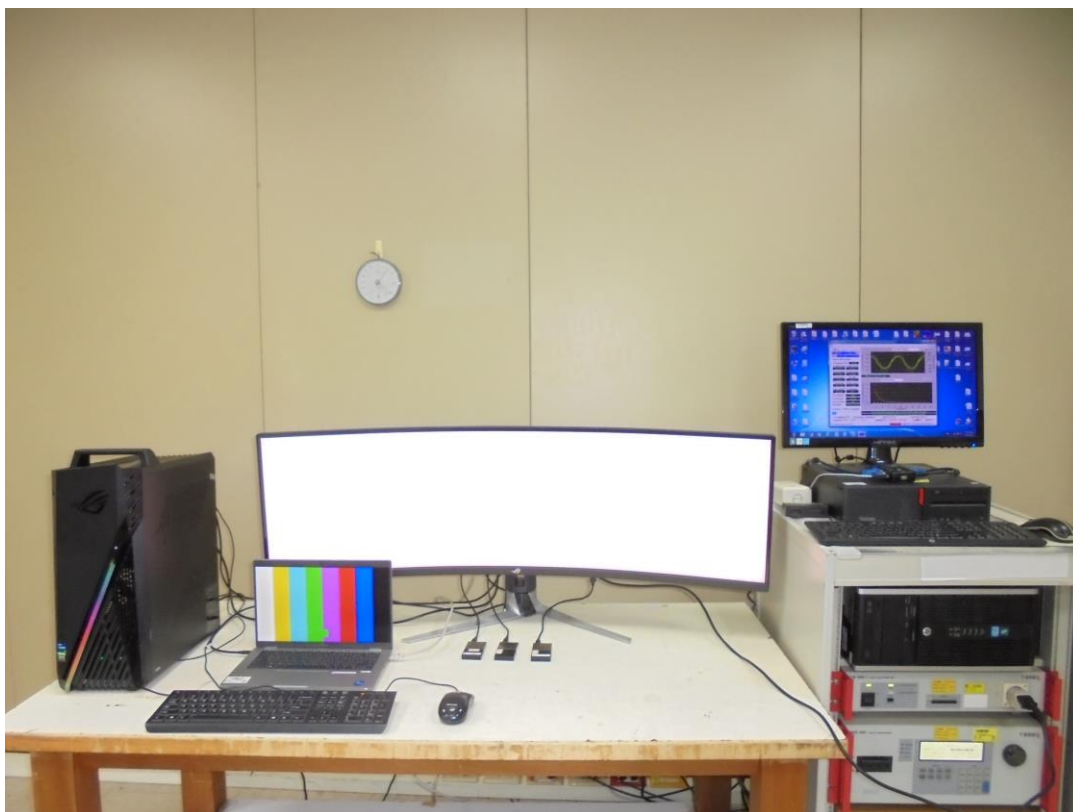

8.6 Voltage Fluctuations and Flicker Measurement

Mode A

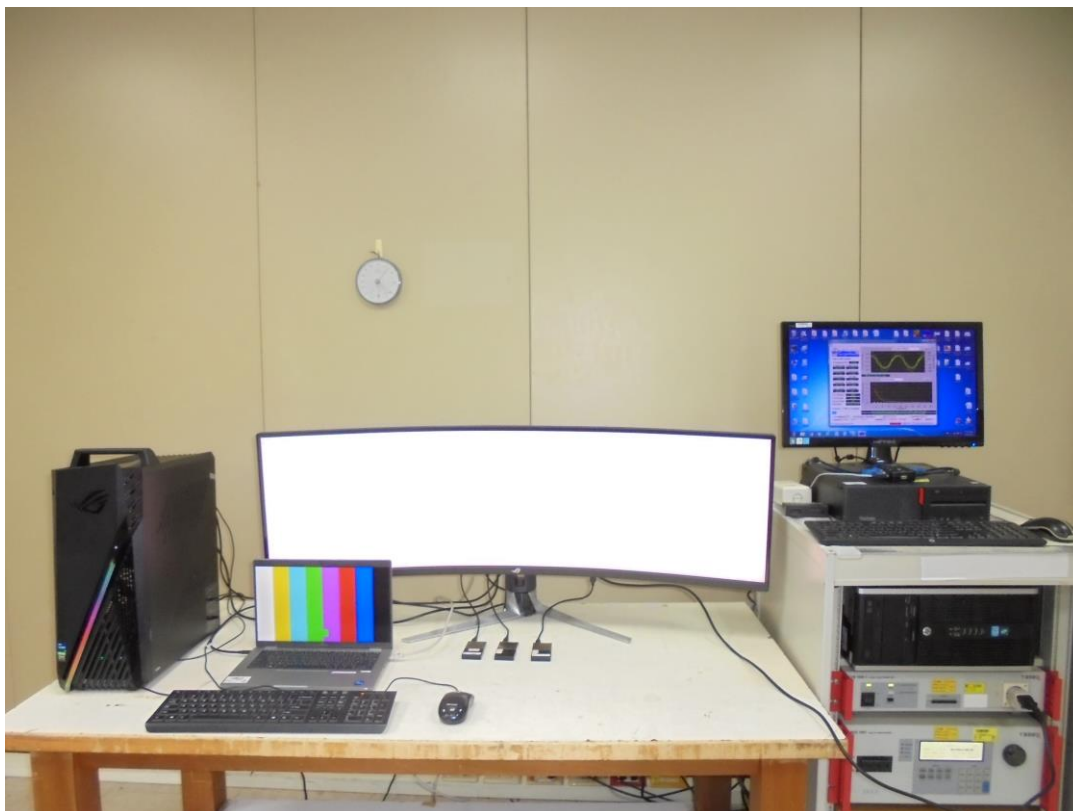

8.7 Electrostatic Discharges (ESD)

Mode A

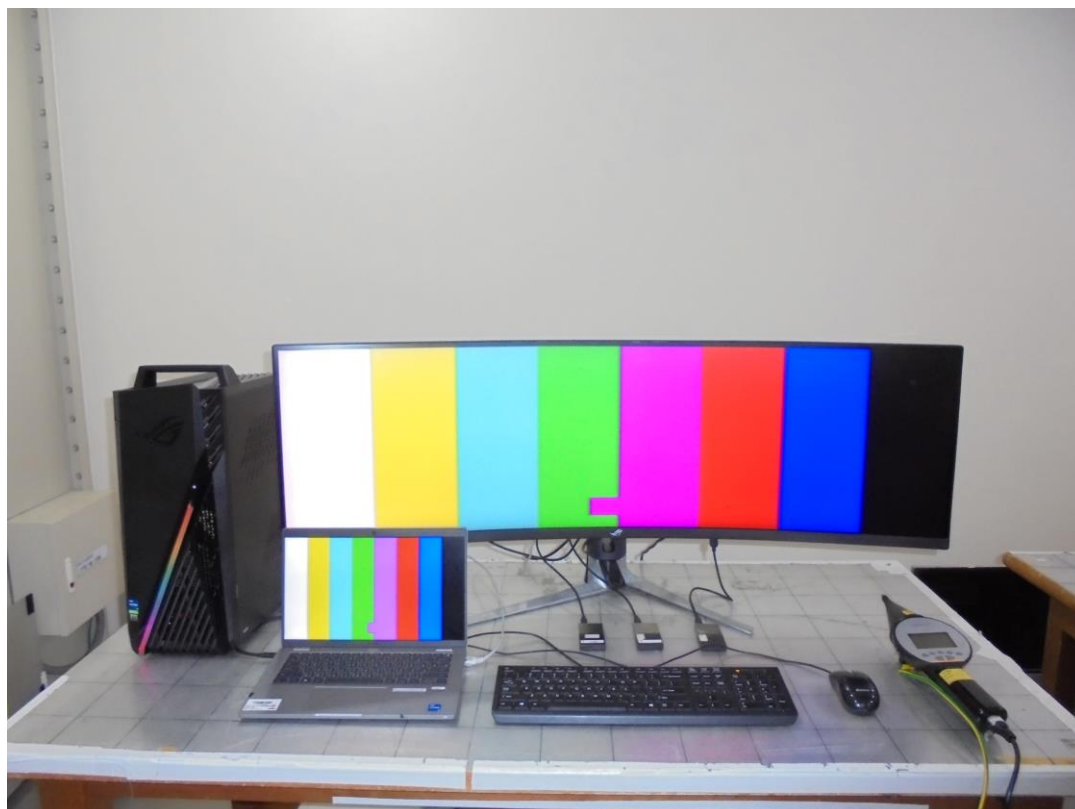

8.8 Radio Frequency Electromagnetic Field (RS)

Mode A

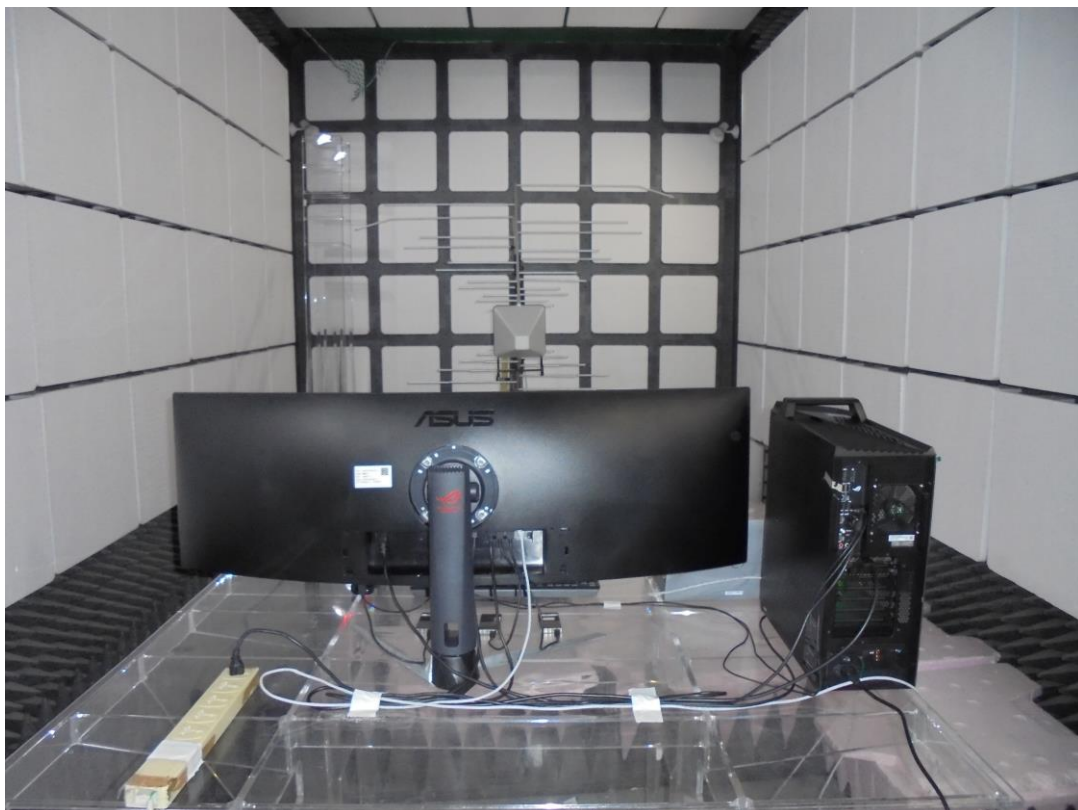
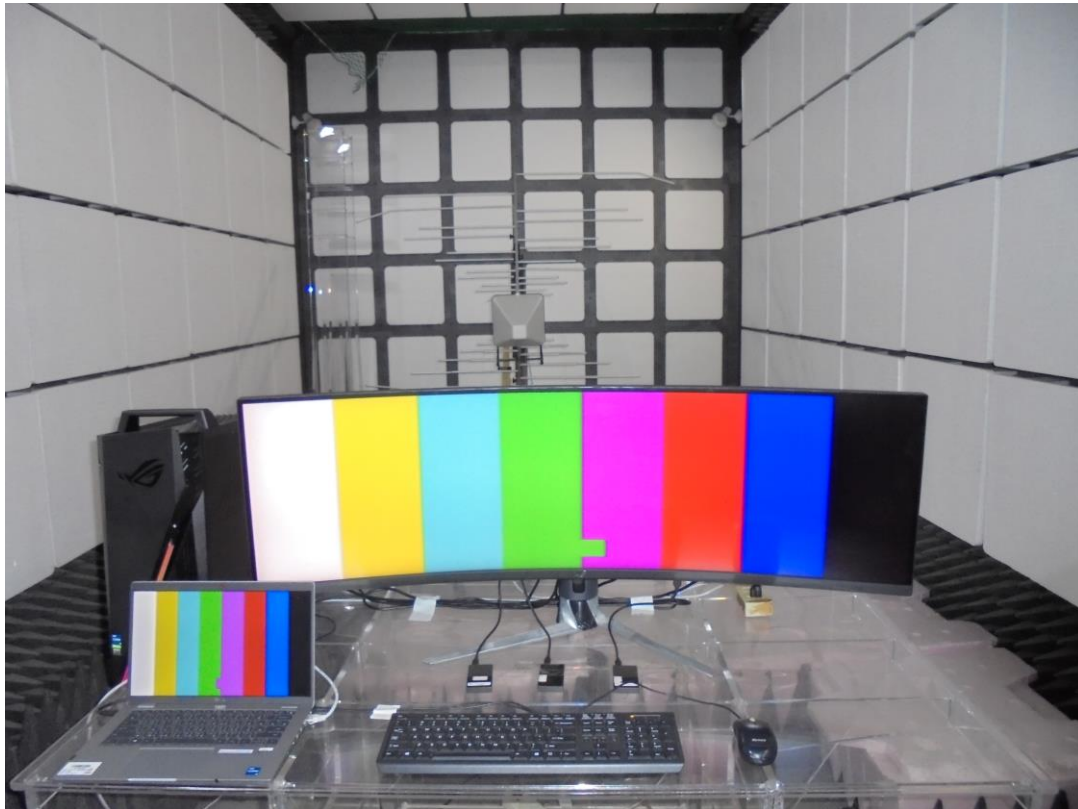

8.9 Fast Transients Common Mode (EFT)

Mode A

AC



LAN



8.10 Surges

Mode A

AC



8.11 Radio Frequency Common Mode (CS)

Mode A

AC

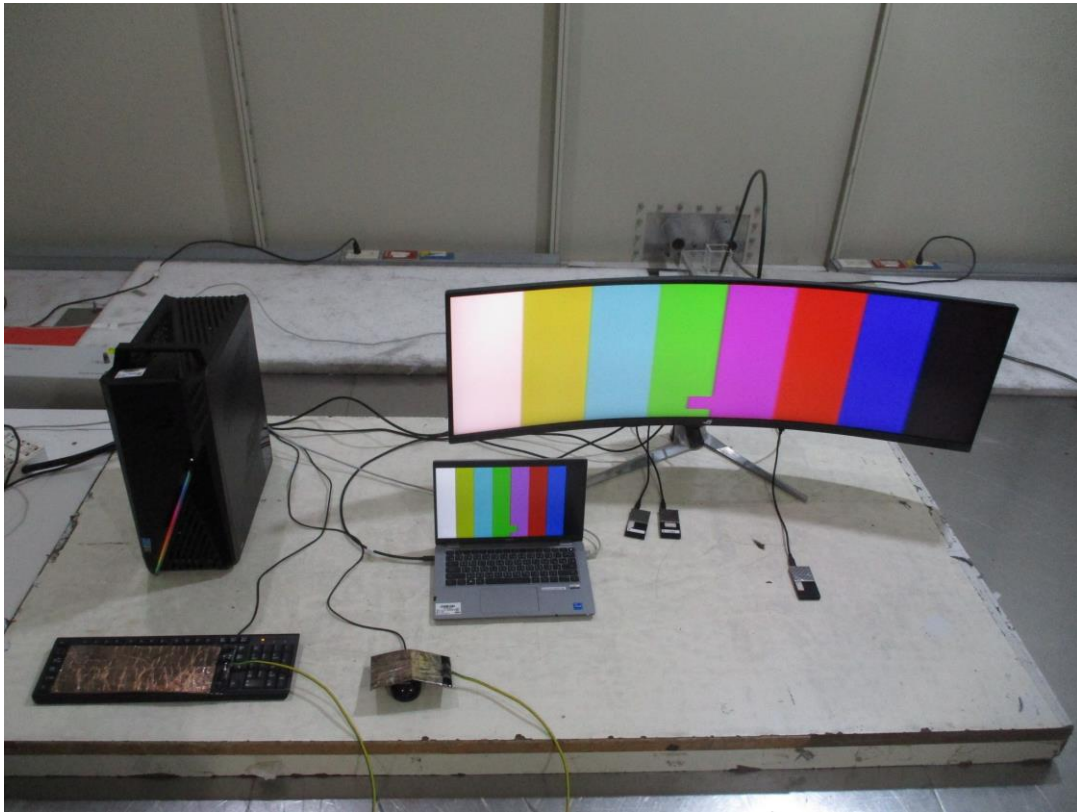

LAN

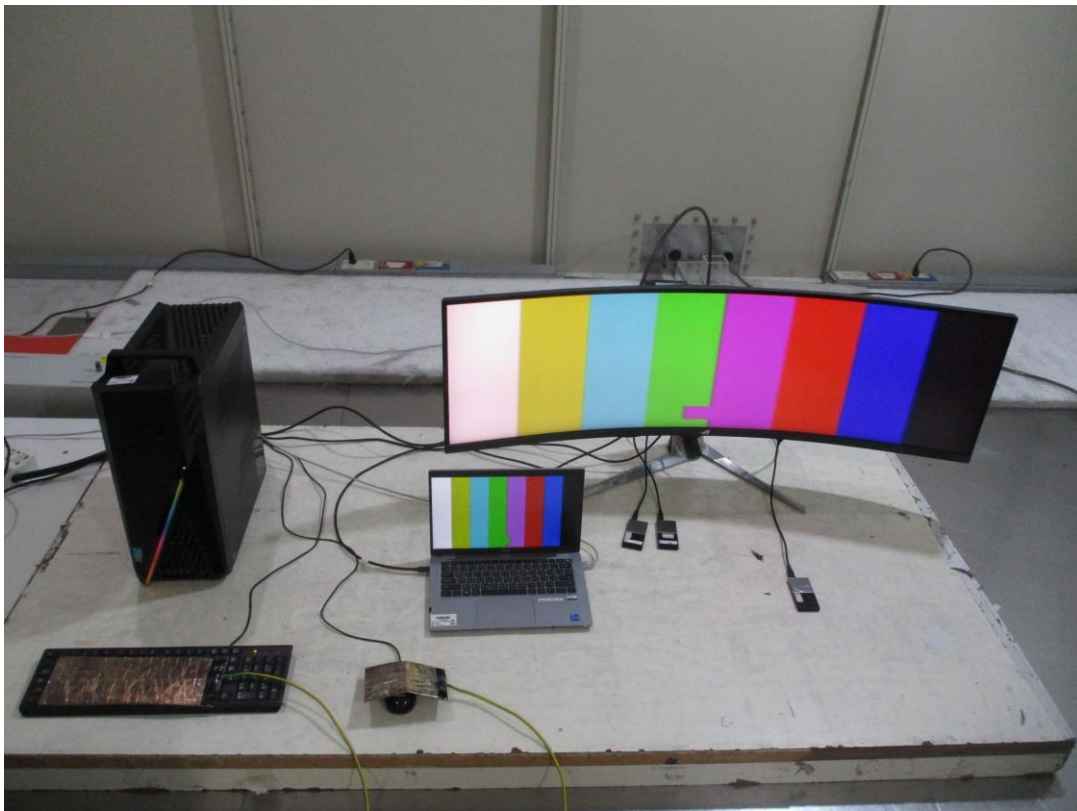

8.12 Power Frequency Magnetic Field (PFMF)

Mode A

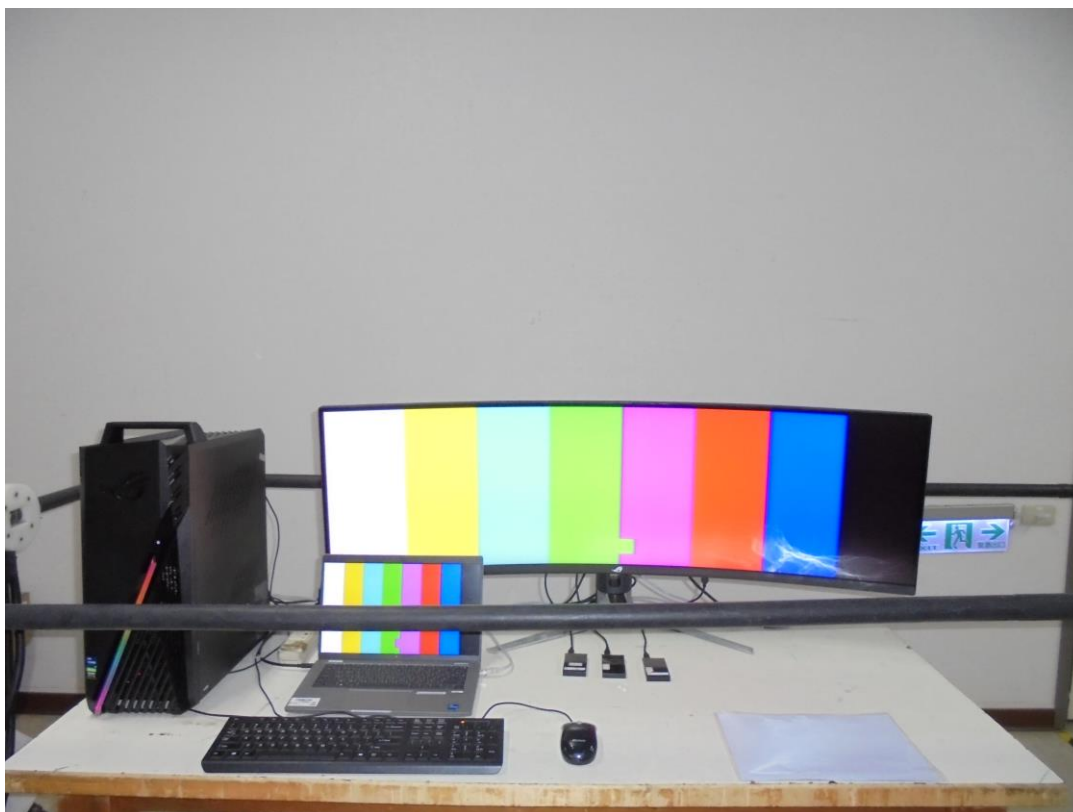

8.13 Voltage Dips and Interruptions (DIP)

Mode A



9 Information of the Testing Laboratories

We, Bureau Veritas Consumer Products Services (H.K.) Ltd., Taoyuan Branch, were founded in 1988 to provide our best service in EMC, Radio, Telecom and Safety consultation. Our laboratories are FCC recognized accredited test firms and accredited according to ISO/IEC 17025.

If you have any comments, please feel free to contact us at the following:

Lin Kou EMC/RF Lab

Tel: 886-2-26052180

Fax: 886-2-26051924

Hsin Chu EMC/RF/Telecom Lab

Tel: 886-3-6668565

Fax: 886-3-6668323

Hwa Ya EMC/RF/Safety Lab

Tel: 886-3-3183232

Fax: 886-3-3270892

Email: service.adt@bureauveritas.com

Web Site: <http://ee.bureauveritas.com.tw>

The address and road map of all our labs can be found in our web site also.

--- END ---