



CREATOR™

3 IN 1

31134



3 in 1
3 en 1

3 em 1
3 合 1

3 w 1
3 v 1

3 az 1-ben
3 in 1

"3 в 1"
Kolm ühes

3 viename



 **FR**
DONNEZ
OU
RECYCLEZ

 OU  OU 

ASSOCIATION MAGASIN DÉCHÈTERIE

Adresses sur quefairedemesdechets.fr



LEGO.com/sustainable-packaging

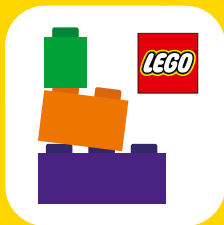

BUILDER



Apple and the Apple logo are trademarks of Apple Inc., registered in the U.S. and other countries and regions. App Store is a service mark of Apple Inc. Google Play and the Google Play logo are trademarks of Google LLC. Tencent and the Tencent logo are trademarks of Tencent Inc.

 LEGO.com/devicecheck

EN Ask parents' permission before going online | **DE** Eltern um Erlaubnis bitten, bevor du online gehst | **FR** Demande l'autorisation d'un parent avant d'aller en ligne | **IT** Chiedi il permesso ai tuoi genitori prima di andare online | **ES** Pídeles permiso a tus papás antes de conectarte a Internet | **PT** Pede autorização aos pais antes de acederes online | **JA** オンラインになる前に ほご者の方のきよかをもらおう | **ZH** 上网前应先征得父母的同意 | **KO** 온라인 접속 전에 보호자 동의가 필요합니다 | **RU** Спроси разрешения у родителей, прежде чем заходить в интернет | **PL** Poproś rodziców o zgodę, zanim wejdiesz do Internetu | **CS** Než půjdeš na internet, požádej rodiče o svolení | **SK** Skôr než pôjdeš na internet, vypýtaj si povolenie od rodičov | **HU** Kérj szülői engedélyt, mielőtt online csatlakoznál! | **RO** Cere permisiunea părinților înainte de a te conecta online | **BG** Поискайте разрешение от родител, преди да влезете онлайн | **LV** Pirms došanās tiešsaistē palūdz atļauju vecākiem | **ET** Enne Interneti kasutamist küsi vanematelt luba | **LT** Prieš prisijungdami prie interneto, atsiklauskite tėvų





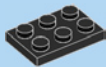

1x



1x

1

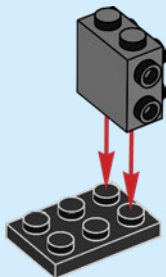



2x

2

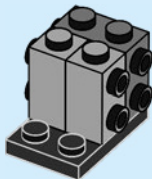



1x

3

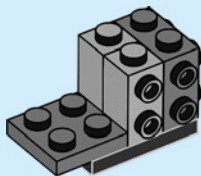

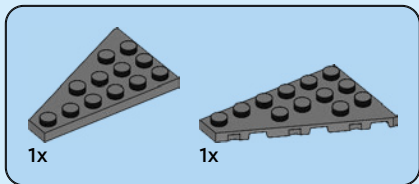

4

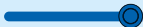
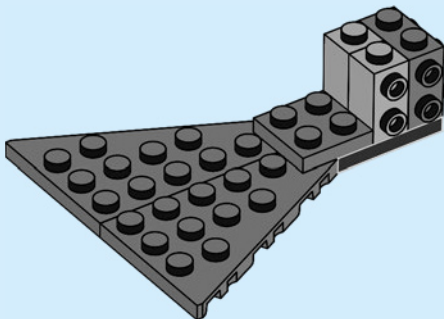



2x

5

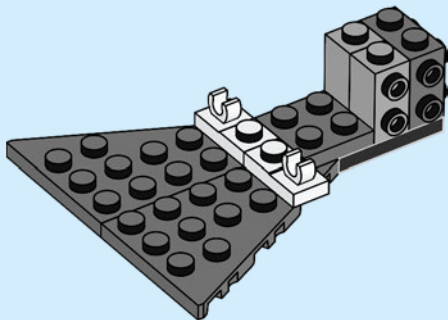

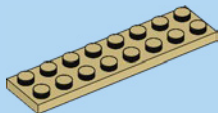

1x

6

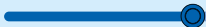
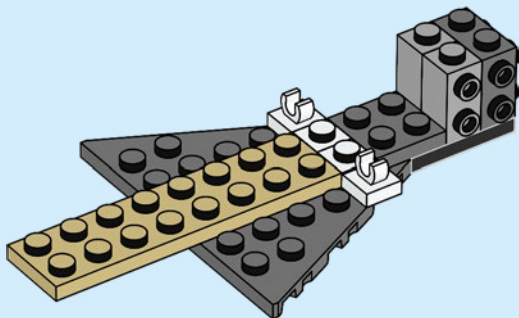



1x

7

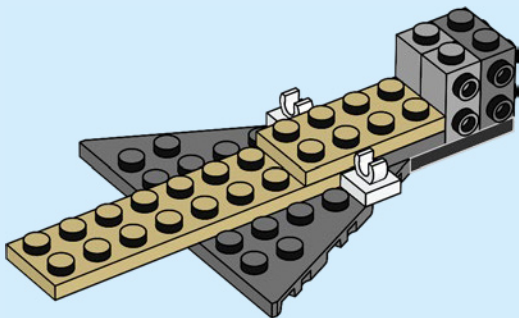



1x



2x

8

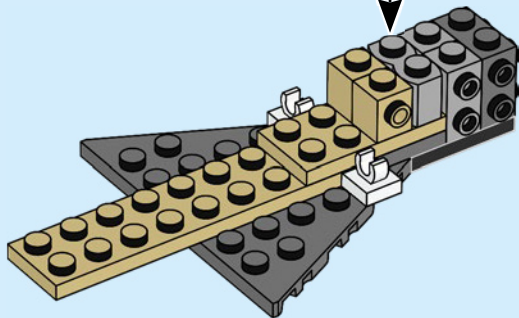
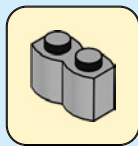



2x

9

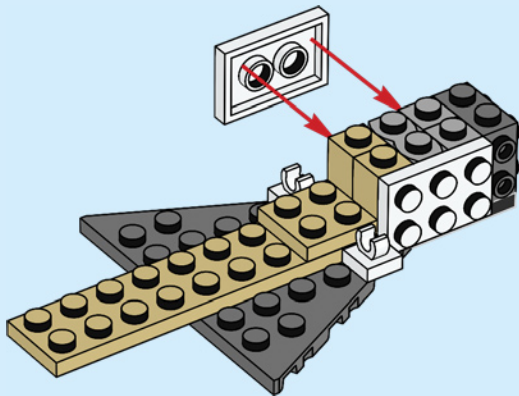



2x



2x

10

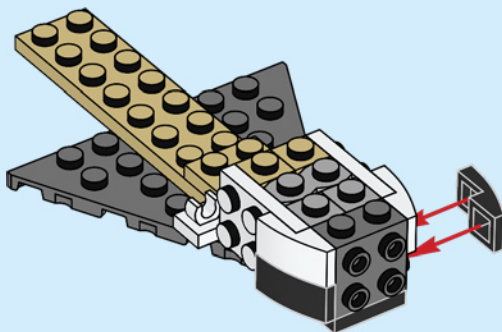
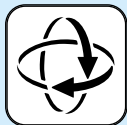



2x

11

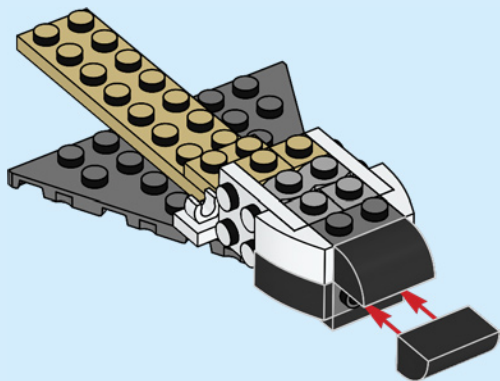

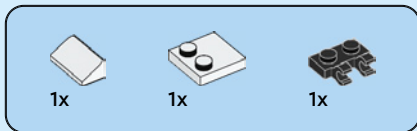

12

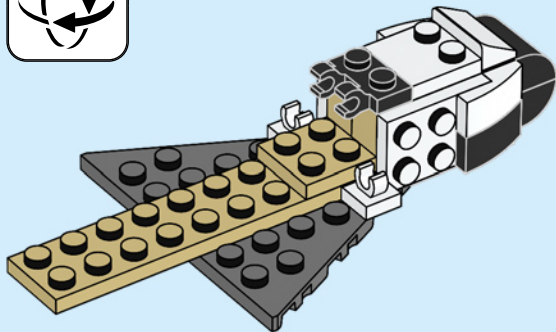
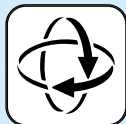



2x

13

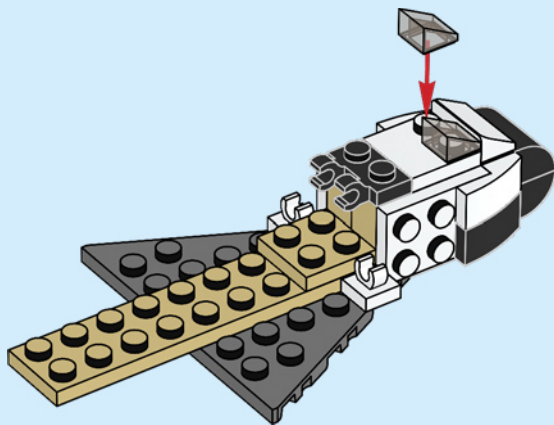

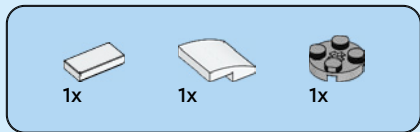

14

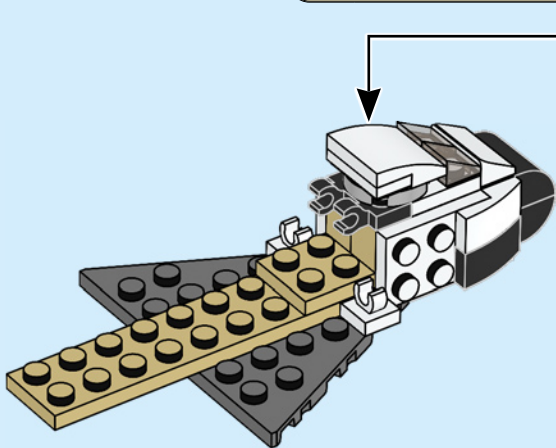
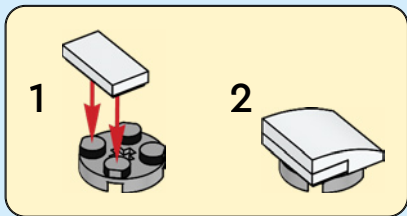

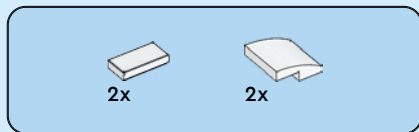

15

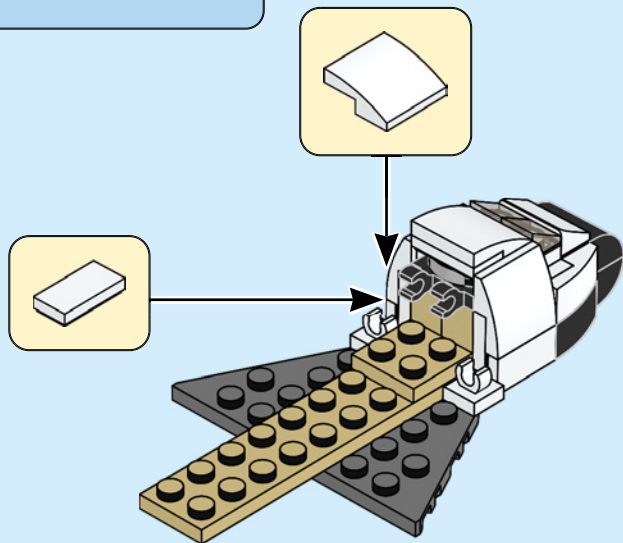



1x



1x

16

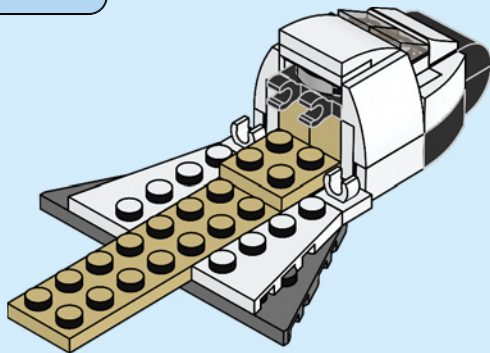

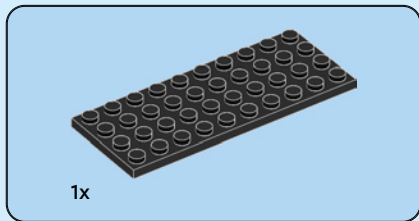

17

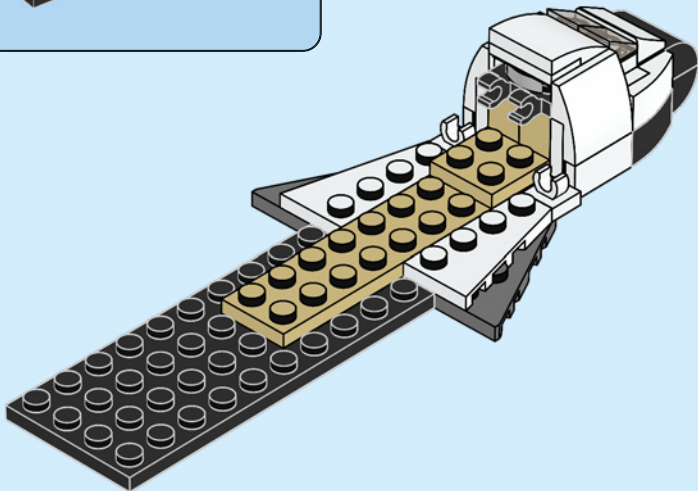



2x

18

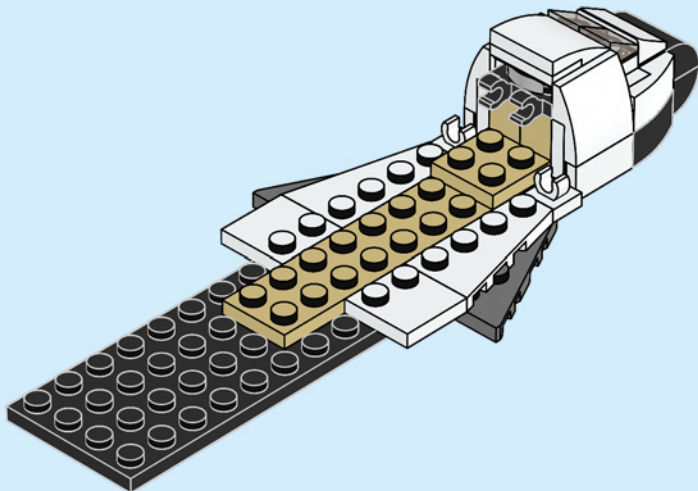



4x

19

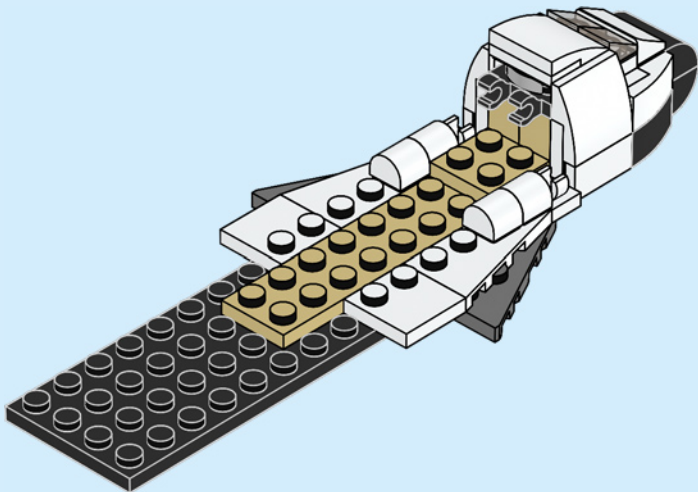



2x

20

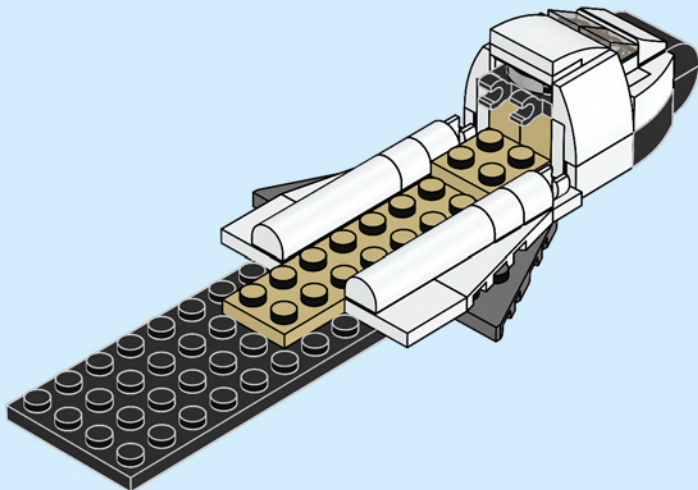

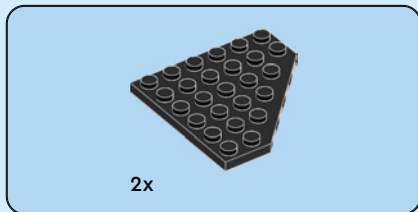

21

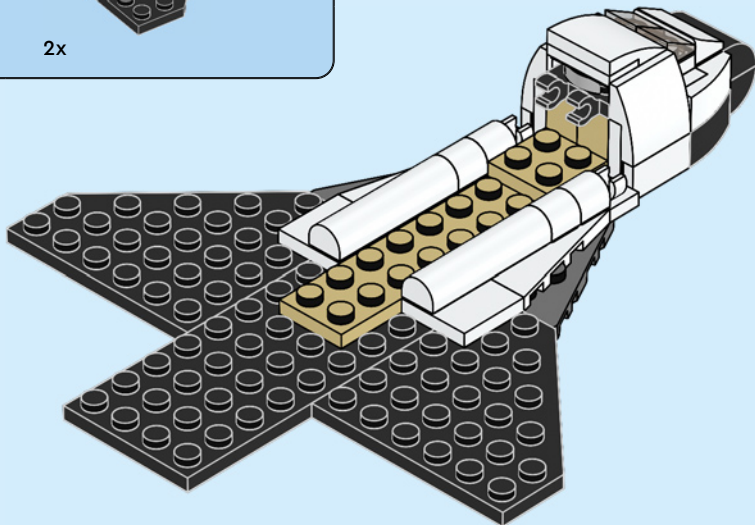



2x

22

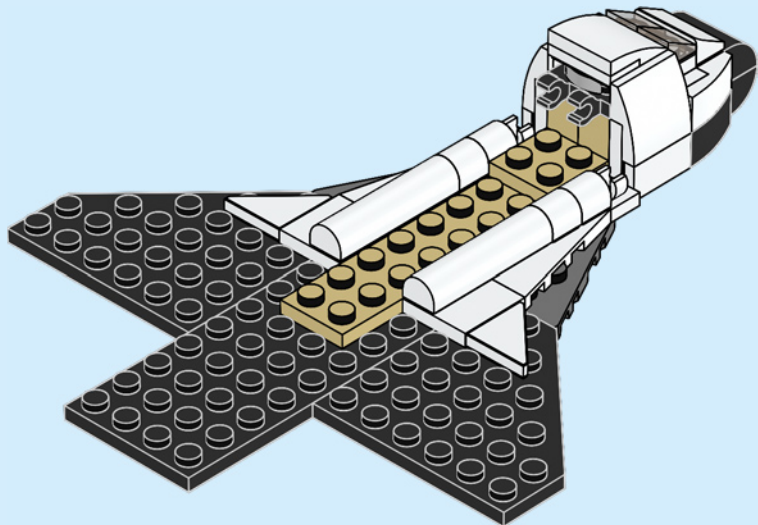



2x



2x

23

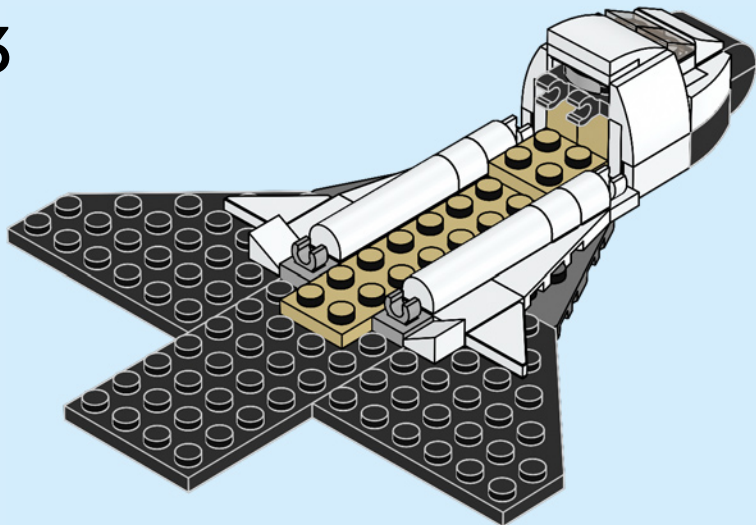



2x



2x

24

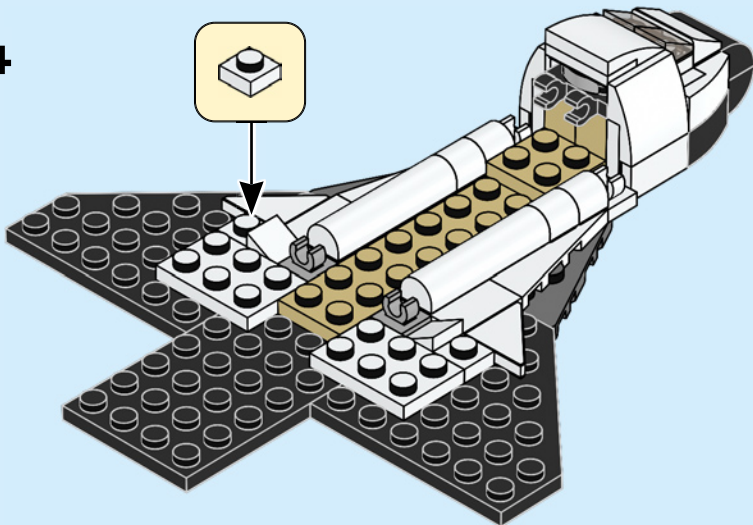



1x



2x

25

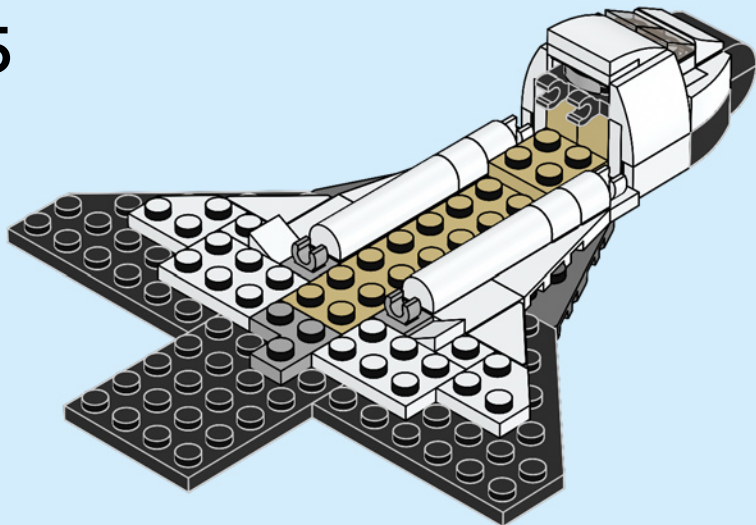



2x



2x



2x



1x

26

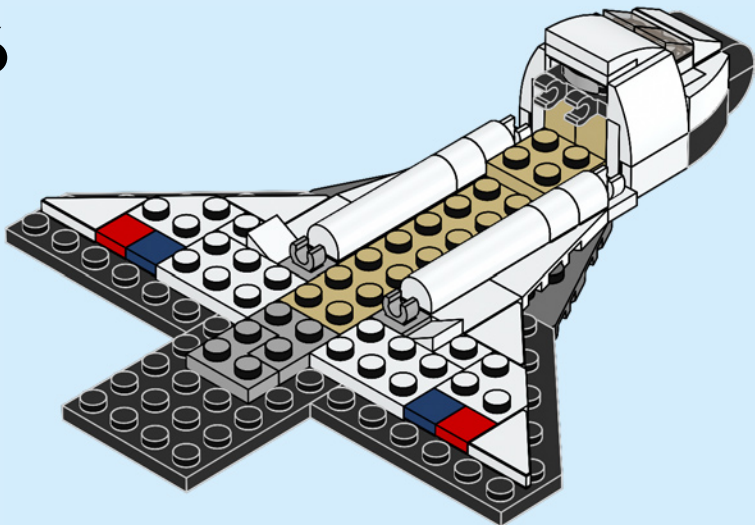

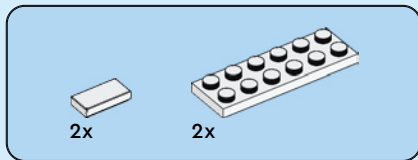

27

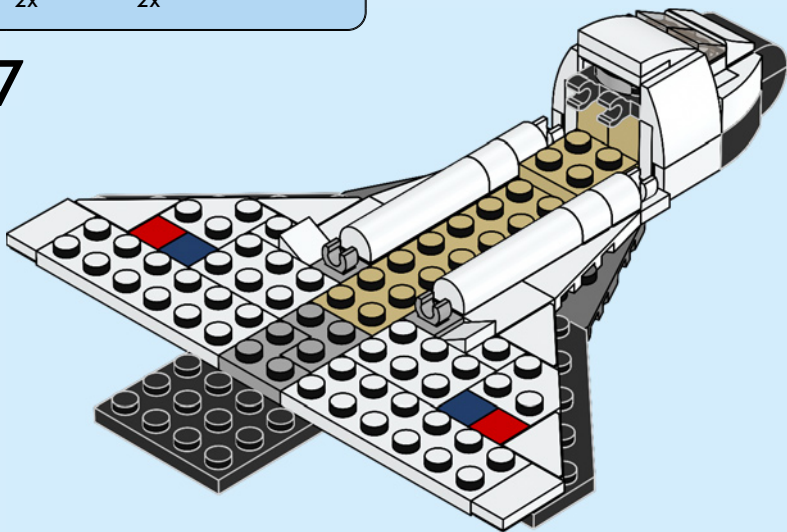

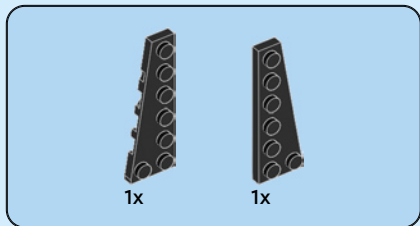

28

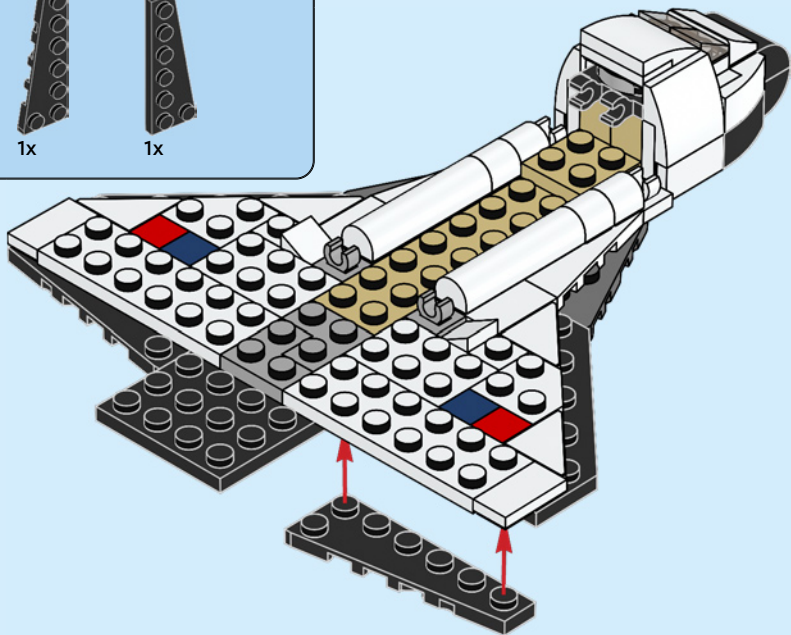



1x

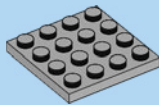

1x

29

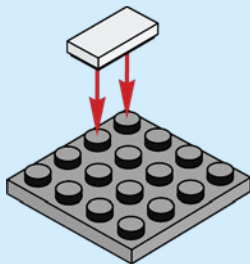

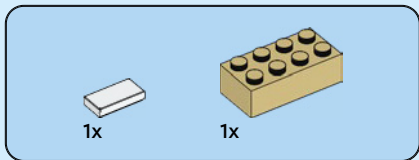

30

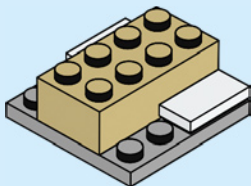



1x

31

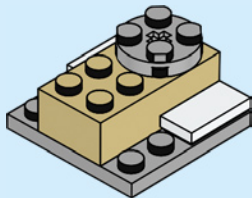



1x



1x

32

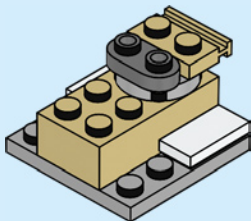



2x

33

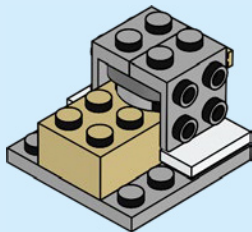



2x

34

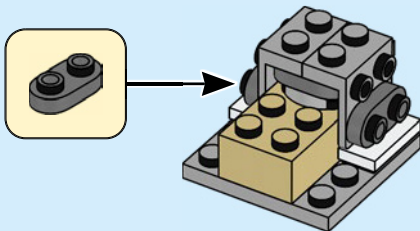



2x

35

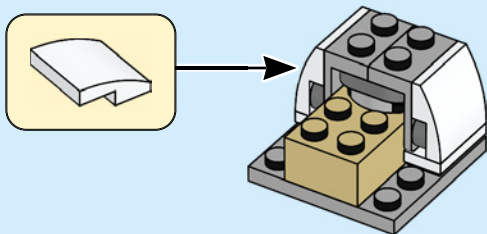



1x



1x

36

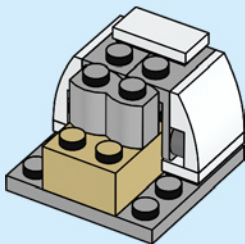



2x



2x

37

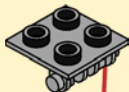

2x

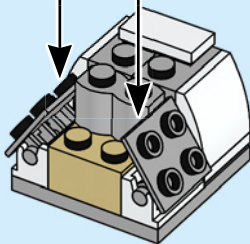

38

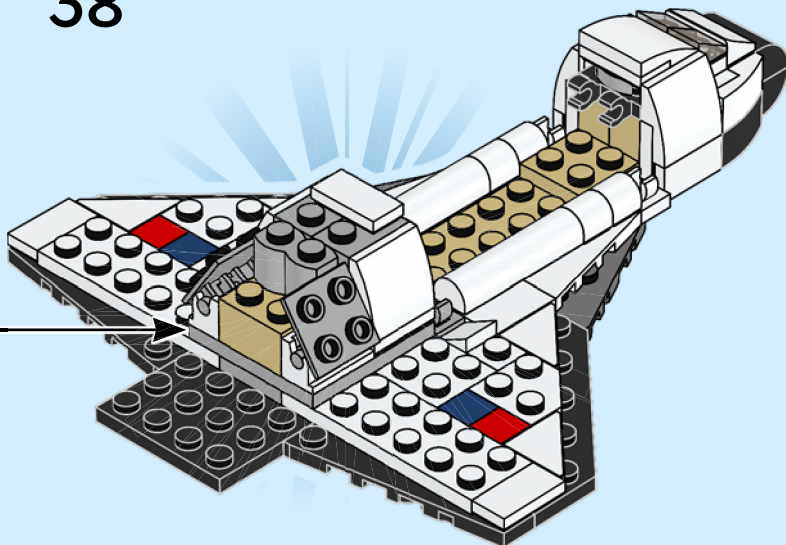

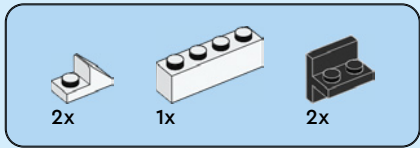

39

1

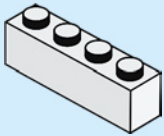

2

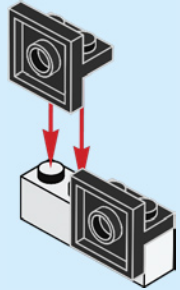

3

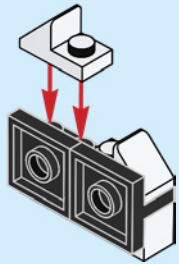

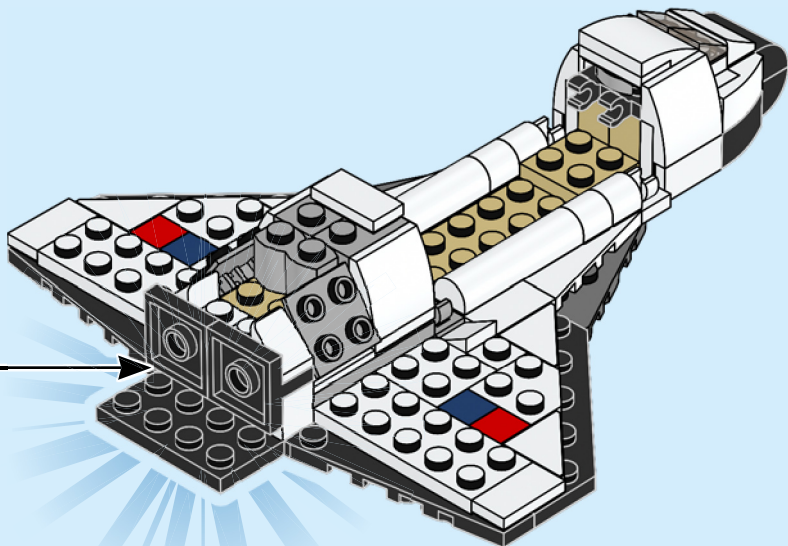



1x



1x



1x

40

1

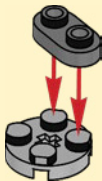

2

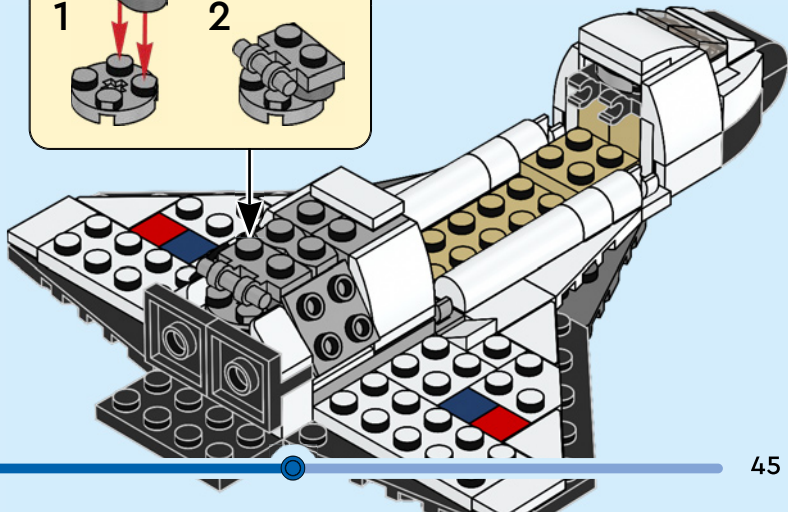



2x



2x

41

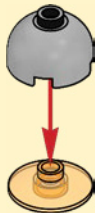

2x

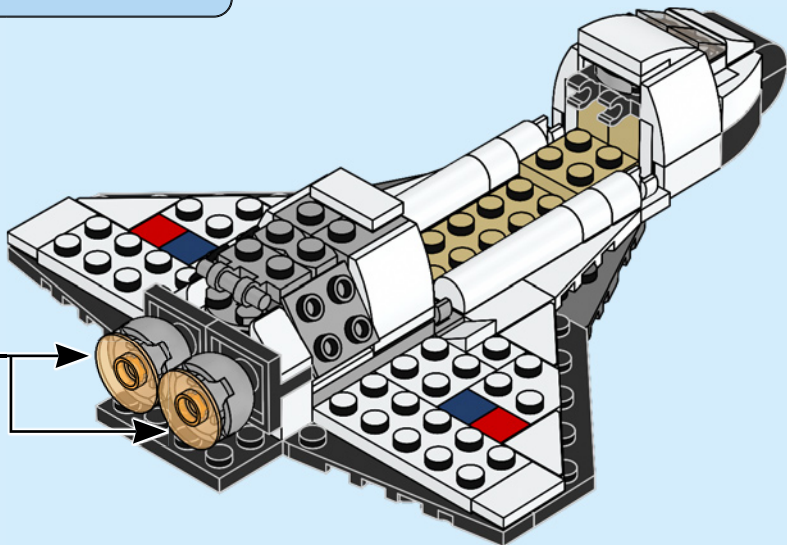



2x

42

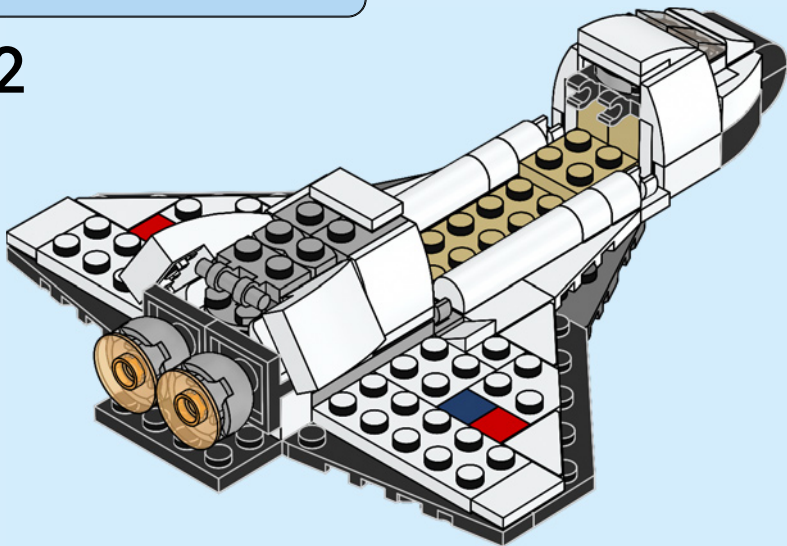

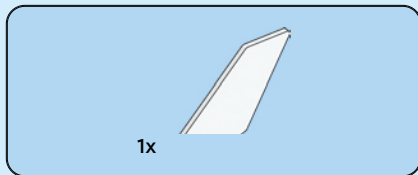

43

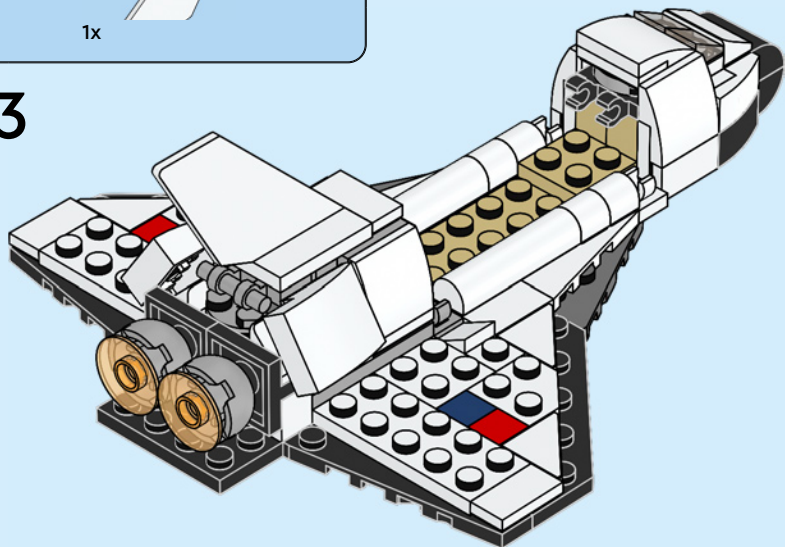



1x



1x



1x

44

1

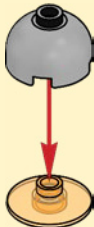

2

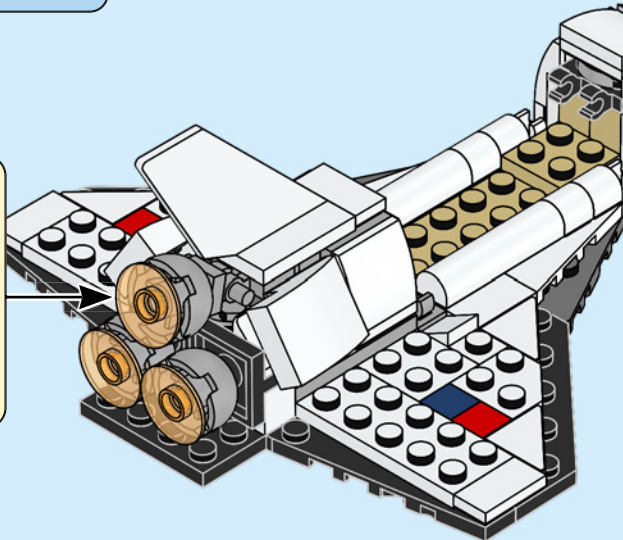



2x



1x



2x

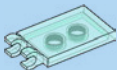

2x

45

1

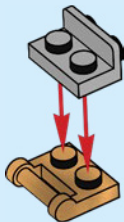

2



3

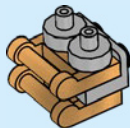

4

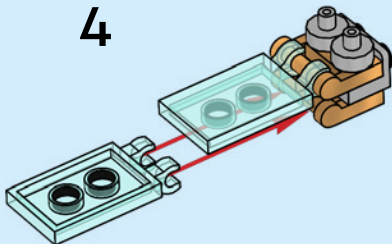

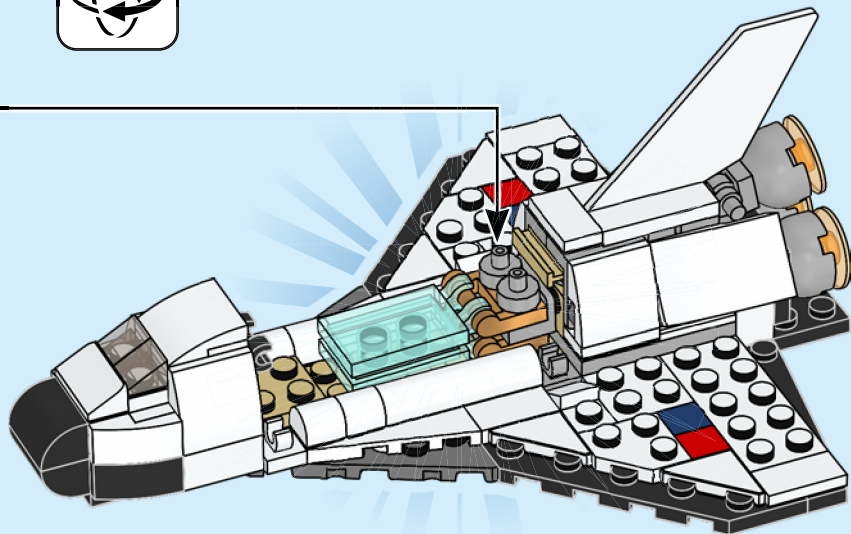
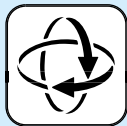

47

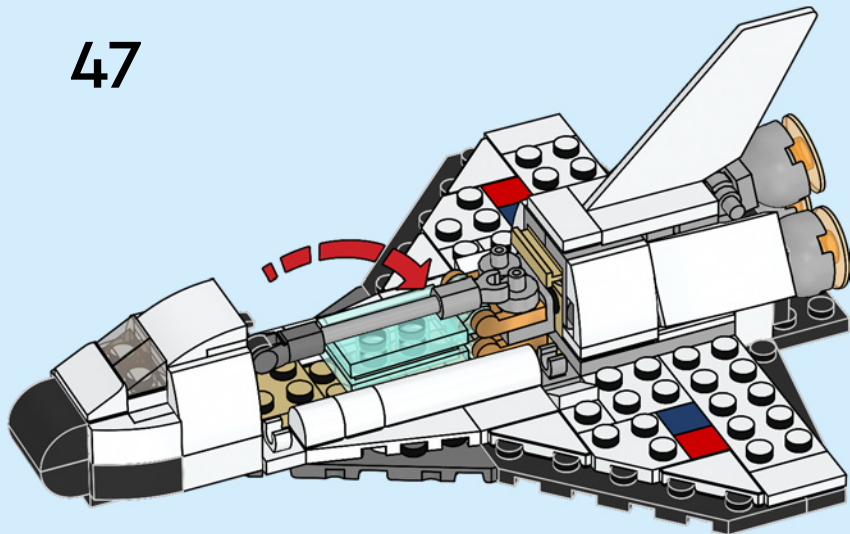



2x



2x



8x



2x



8x



4x

48

1

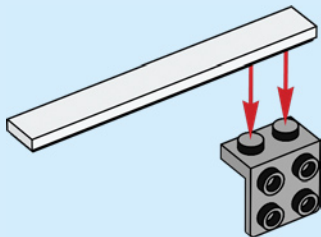

2

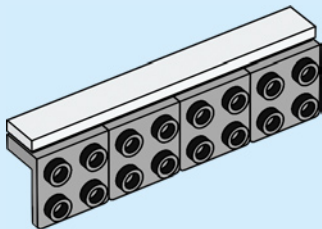

3

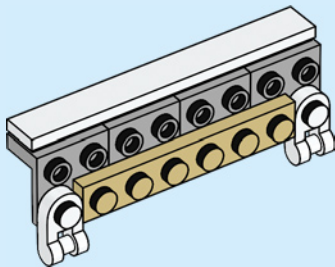

4

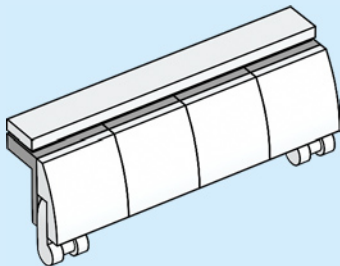

2x

