

Instruction Manual

Version 1.0.1

Please read this manual before operating
the TS100(this instruction
manual is based on APPV2.11

Content



WARNING: Failure to comply a WARNING may result in serious injury to the user or others.



CAUTION: Failure to comply a CAUTION may cause damage to the product or other equipments.



NOTE: Annotations, operation notes or additional information.



1 Safety Statement

P1



2 Overview

P3



3 Power Adaptor Selection

P5



4 Operation

P6



5 Soldering Iron Tip

P14



6 Trouble Shooting Guide

P16



7 Technical Support

P18



8 Legal Statements

P20

1.1 General Safety



- Use only certified power source/adaptors from your region. (please refer to 3.0 for specifications)
- Do not operate in humid environment.
- Do not operate in inflammable/explosive environment.
- Keep the surface of the product clean and dry.

1.2 Working condition

Working condition	Requirements
Temperature	Operating Condition: from 0°C to +50°C
	Non-operating Condition: from -20°C to +60°C
Humidity	Operating Condition: from 40°C to 50 °C, 0% to 60% RH
	Operating Condition: from 0°C to 40 °C, 10% to 90% RH
	Non-operating Condition: from 40°C to 60°C, 5% to 60%RH
	Non-operating Condition: Low temperature: from 0°C to 40°C, 5% to 90%RH

1.3 Warnings



When using TS100,
Turn the power off when not in use, or left unattended.
When power is ON, tip temperatures will be between
100°C~400°C(212°F~752°F), please be careful.
Please don't operate TS100 when it's wet or operate
it with wet hands, which will cause an electric shock.

1.4 Cautions



When using TS100,

- The handle is constructed with precision, dropping shall be avoided.
- After continuous use up to 40 minutes, the handle surface temperature will reach 50°C~60°C.
- For the first time using, TS100 may generate a light smoke due to the heating of heating elements, which is a normal phenomenon.

1.5 Liability Statement



Any damage of the product, or losses related to the product damage,
if it's man-caused, or assumed to be man-caused, the liability will belong to
the user.

2.1 Ports and Control Panel Introduction

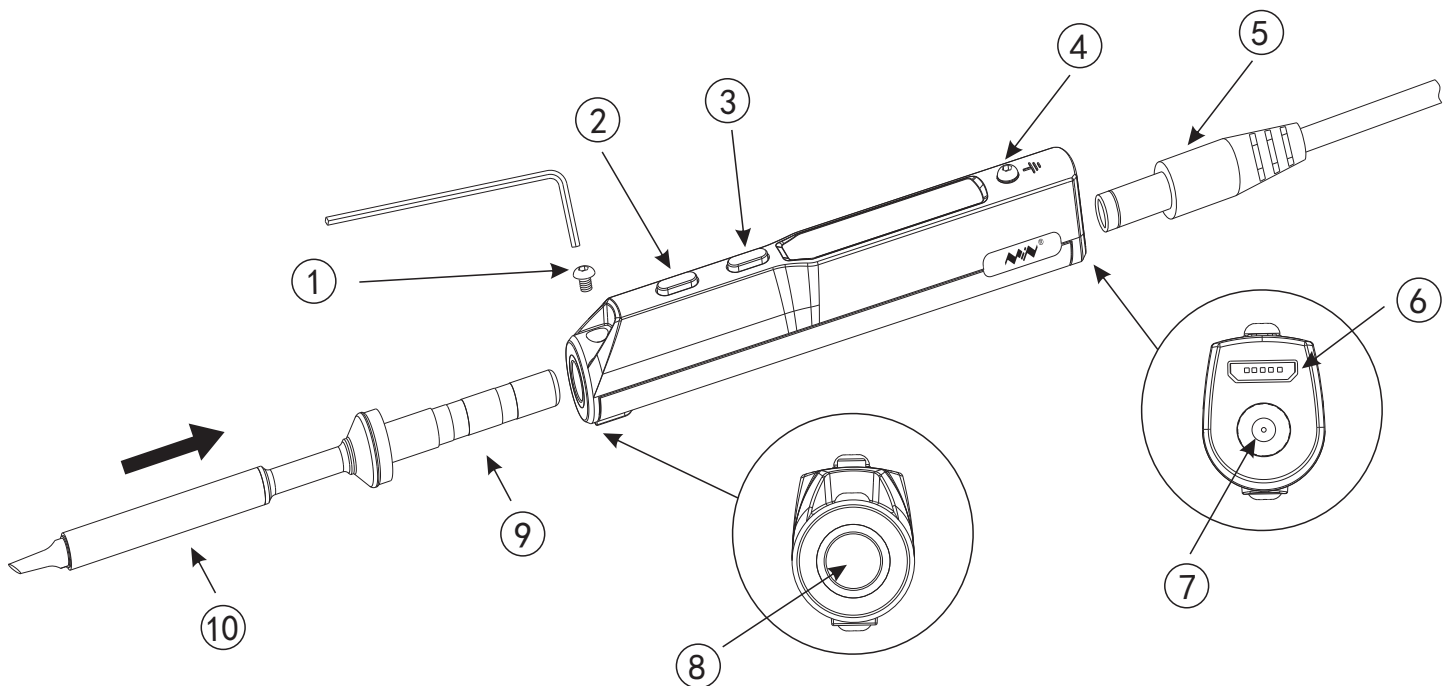

1. The tip setscrew
2. Button A
3. Button B
4. Ground cable fixing screw
5. Power connector
6. Micro USB
7. DC5525 12-24V port
8. Soldering tip port
9. Soldering tip connector
10. Soldering tip heating end

2.2 Specifications



Screen		OLED
USB port		Micro USB
Power port		DC5525
Dimensions	Operation unit	Length:96mm , Diameter:16.5mm
	Heating unit	Length:72+33mm , Diameter:5.5mm
Weight		33g(power adaptor not included)

2.3 Operation Specifications



Power	65W
Temperature range	100°C~400°C (max)
Temperature stability	±2%
Operation temperature under heat	40°C
Soldering tip resistance to the ground	< 2 Ω

Before connecting DC5525(12-24V)power adaptor,check if the adaptor is in good condition as below standard.

We would recommend the DYS404-190210V (19V,2.1A)power supply as an accessory for TS100.

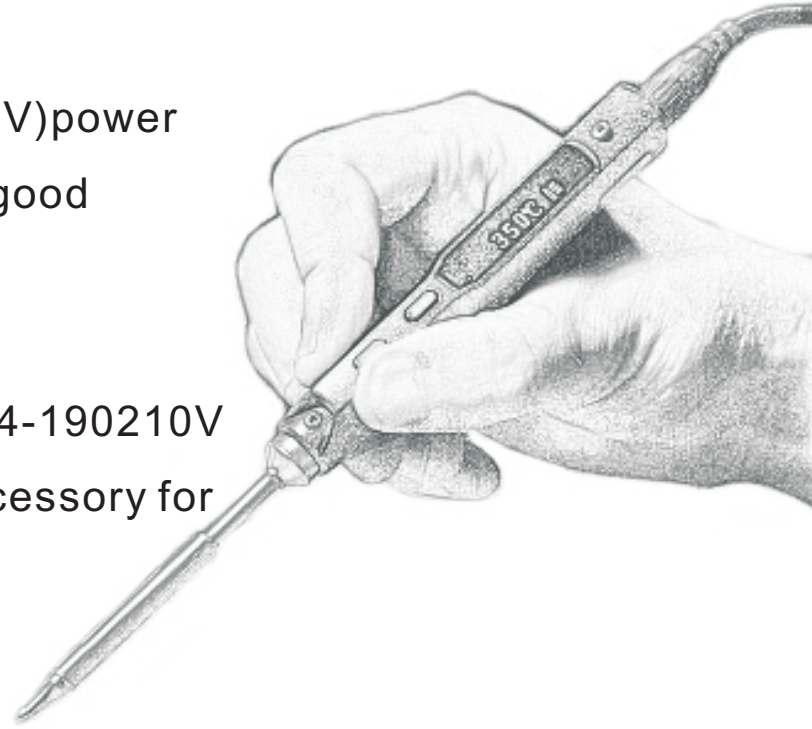

Operation voltage	Power	Electric current	Time required to increased tip temperature from 30°C to 300°C
12V	17W	> 1.4A	40s
16V	30W	> 1.9A	20s
19V	40W	> 2.1A	15s
24V	65W	> 2.7A	11s

4.1 TS100 Installation

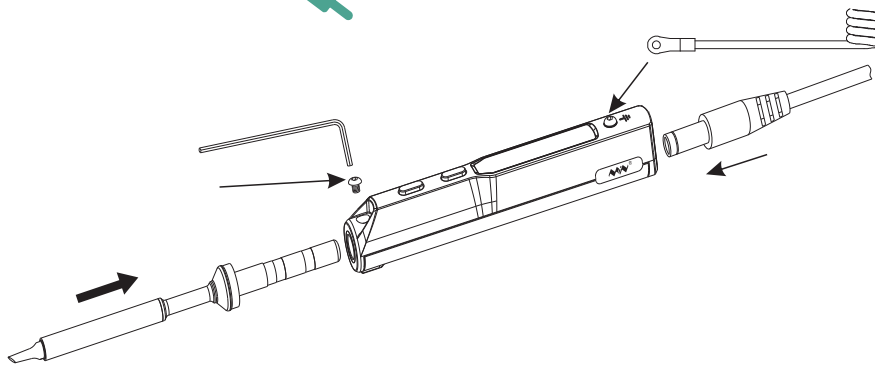

1. Loosen the tip setscrew, insert the soldering tip connector and tighten the screw;
2. Connect the ground wire to the ground wire setscrew ;
3. Connect the DC connector to TS100, connect the power cord and turn on the power accordingly.



Note: If the screen displays "sen-err" when it's plugged, means the soldering iron tip is not properly fixed, please re-install it properly.

4.2 Default Settings

Default temperature unit	°C
Default temperature	300°C (Default)
Sleep mode temperature	200°C (Default)
Adjustable temperature range	100°C~400°C (Max)

4.3 Basic Control

4.3.1 Screen Display

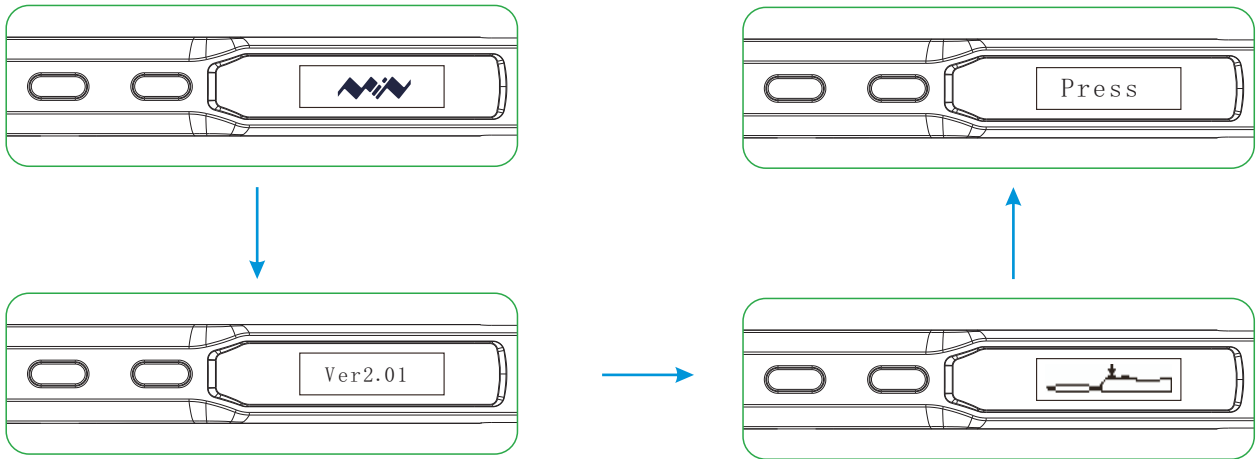

When plugged into DC12-24V power adaptor ,TS100 will display its logo, Version number and its standby screen in sequence.

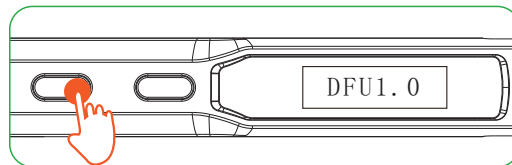

When plugging into DC 12-24V power adaport ,pressing Button A at the sametime will enter DFU mode,"DFU1.0" will appear on OLED screen .

To exit DFU mode: unplug and plug in the device again without pressing any button ,then it will enter standby mode.

4.3 Basic Control

4.3.2 Automatic Calibration

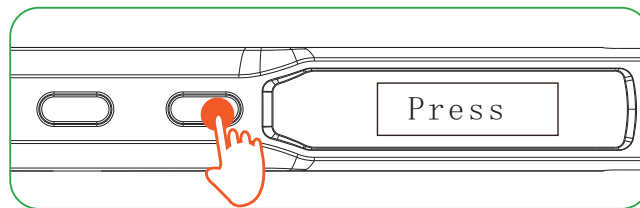

Press Button B in standby mode to enter the thermometer mode

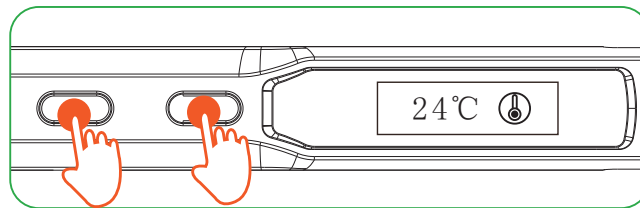

In thermometer mode, press 2 buttons at the same time to enter the calibration mode

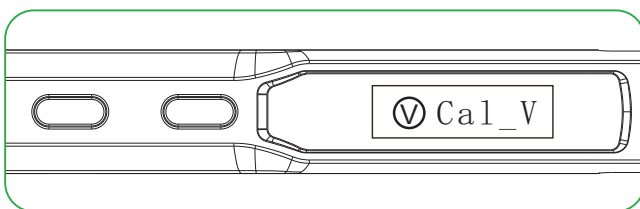

Display shows when calibration is succedd.

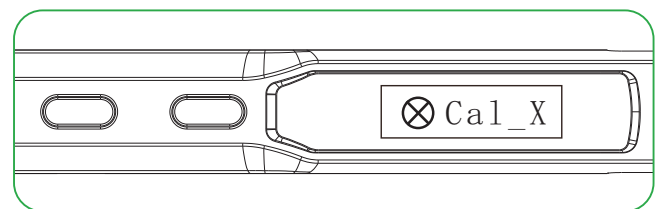

Display shows when calibration failed

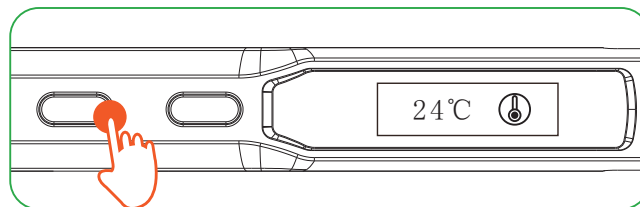

Long press any button to exit thermometer mode



Note: Calibration shall be done when TS100 in room temperature

4.3 Basic Control

4.3.3 Heating up

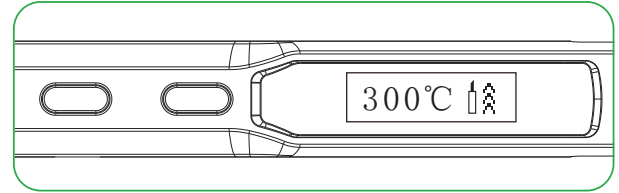
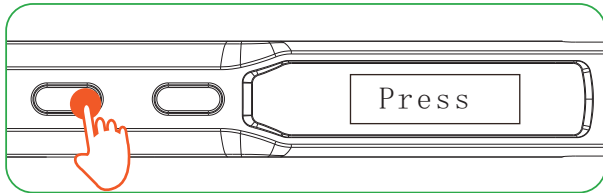

When pressing Button A in standby mode, TS100 will heat up to preset temperature

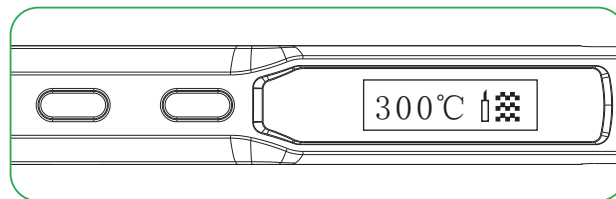

When OLED displays as picture, means it's ready for soldering

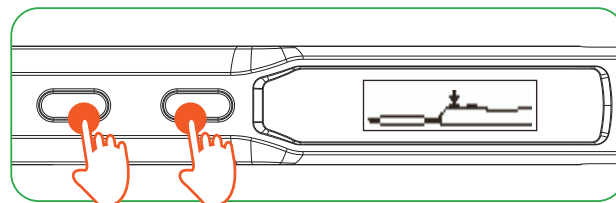

In operation mode, holding both buttons for 3 seconds will return to standby mode

4.3 Basic Control

4.3.4 Temperature Adjustment

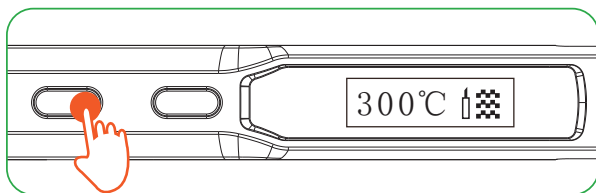

In standby mode, press Button A will enter preset temperature

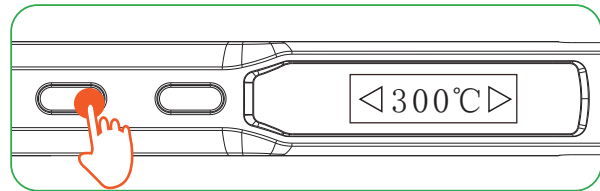

Temperature down: In temperature adjusting mode, hold Button A for at least 2 seconds, until display reads the temperature you want.

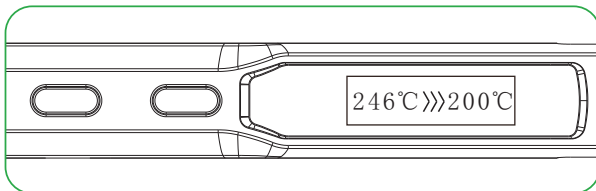

Release Button A when display reads the expected temperature, and TS100 will automatically adjust to it.

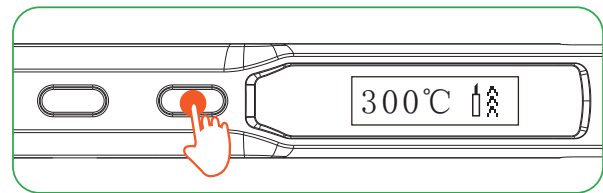

Temperature up: In temperature adjusting mode, hold Button B for at least 2 seconds, until display reads the temperature you want.

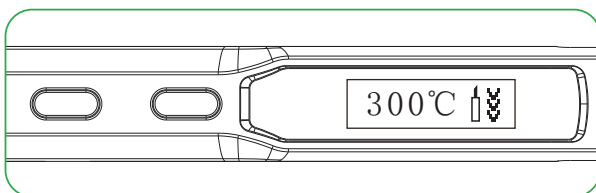

Release Button B when display reads the expected temperature, and TS100 will automatically adjust to it.

4.3 Basic Control

4.3.4 Temperature Adjustment

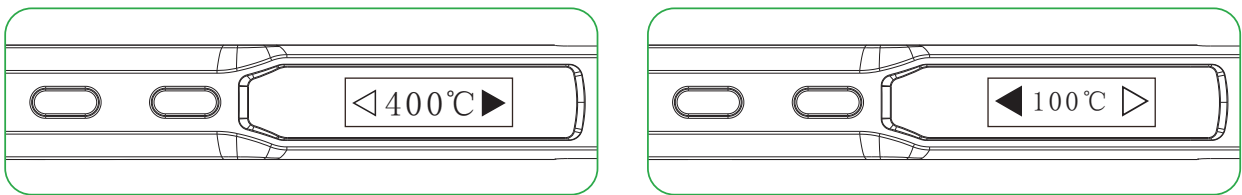

Note: When screen displays arrow pointing to left or right (◀or▶) which means the adjustment has already reached its upper/lower limit temperature, settings will not be saved when power is off

Remark: Maximum temperature: 400°C

Minimum temperature: 100°C

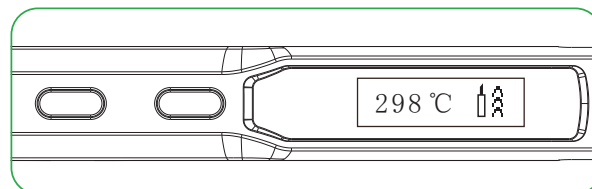

When TS100 temperature stabilizes for 60 seconds, it will automatically enter feedback mode, temperature status will feedback every 5-8 seconds

The last digit on the right end of the display shown as below



Arrows up-heating



arrows down-cooling



horizontal lines- temperature stabilize

4.3 Basic Control

4.3.5 Sleep Mode

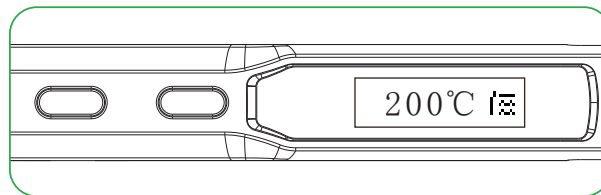

In operation mode, when leaving TS100 for more than 180 seconds (🕒 3 minutes in Default) will trigger the sleep mode, and temperature will automatically adjust to preset sleep temperature.

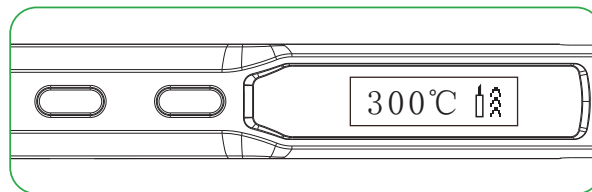

When working, TS100 will restart to operation mode and temperature will automatically heat up to preset temperature (300°C in Default).

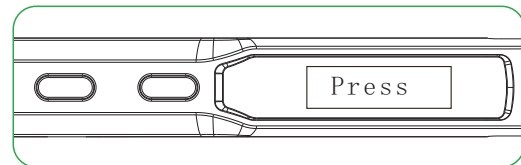
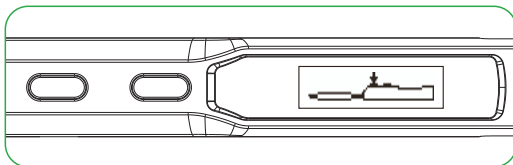

In sleep mode, if it's not being operated for longer than the IDLE_TIME setting, TS100 will then enter the standby mode.

Note: IDLE_TIME can be adjusted (🕒 6 minutes in Default). (Preset minimum IDLE time: 5 minutes)

4.4 System Parameters

Parameter	Explanation	Default	Adjustable range
T_Standby	Standby mode temperature	200°C	100°C~400°C
T_Work	Operating temperature	300°C	100°C~400°C
Wait_Time	Time from operation mode to sleep mode	180 seconds	60~9999 seconds
Idle_Time	Time from sleep mode to standby mode	360 seconds	300~9999 seconds
T_Step	When preset "1", each step will progress in 1,2,5,25; when preset 2-25, each step will progress according to settings	10	5-25
Turn_Off_v	When operation voltage is lower than default voltage TS100 will return to standby mode	10V	9-12V
TempShowFlag	Temperature unit selection	°C	0 is °C , 1 is °F
ZeroP_Ad	Temperature calibration parameter, TS100 automatical adjustment		No manual setting required



Notice: Preset parameter(s) will be updated to TS100 after saved.

5.1 Changing Soldering Tips

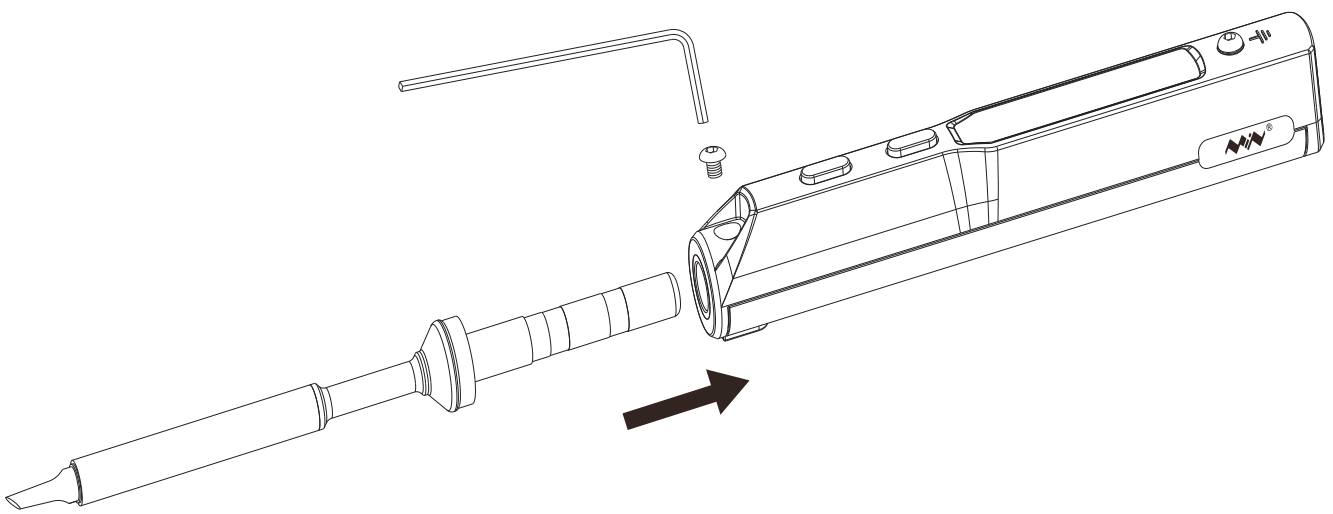

1. Unplug TS100 before changing.
2. Loosen the tip setscrew.
3. Pull out the tip, replace with another one.
4. Tighten the screw.

Note: When TS100 displays "sen-err", it means the soldering iron tip is not installed properly.

5.2 Choosing Soldering Iron Tips

Note: Choosing the right tips will help you to work more efficient

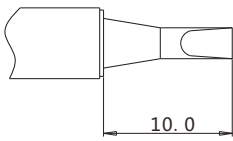

TS-D24

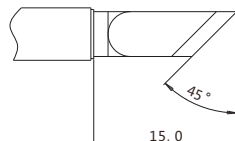

TS-K

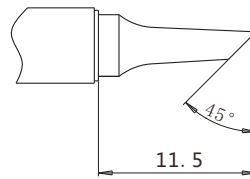

TS-BC2

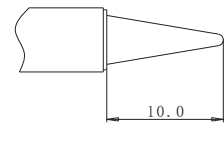

TS-B2

5.3 Soldering Iron Tip Maintenance

- (1) Before switching off, wipe the tip's soldering side with some solder.
- (2) Do not leave the tip in high temperature for long time, which may cause it burn out.
- (3) Do not push too hard while soldering, which will damage the tip.
- (4) Do not use rough material or files to clean the tip.
- (5) If the tip surface is oxidized and makes it hard to apply solder on it, you may use 600~800 grit sandpaper to wipe the tip with Ethanol or Isopropyl alcohol, heat up to 200°C and apply solder immediately to avoid it oxidize again.
- (6) Do not use Flux that contains high chlorine or acid, use only resin based flux.

5.4 Soldering Iron Tip Lifespan

Soldering iron tips lifespan is related to its maintenance (refer to 5.3) and use intensity.

Problem 1:No Display

Check:If the cable is broken

Check:Is there any data in USB mode

Check:If the screen needs to be replaced

Problem 2:Every time when installing a new tip, the temperature status display random numbers

Means the machine is checking status,which is normal

Problem 3:Soldering iron restart automatically

Check 1:Is it properly plugged into the power source?

Check 2:Is the voltage too low?

(need to be set up in the config file)

Problem 4:Soldering iron is heating up and cooling down simultaneously

Check 1:Is the tip first time in use?

Check 2:Is the power cord in loose or defective contact?

Check 3:Is the tip overheating?

Set the temperature in appropriate level

Check 4:Is the soldering iron clean?

refer to "Soldering iron tip maintenance"

Problem 5:OLED shows "Warning!"

Check 1:Is the TS100 overheating?

Is TS100 temperature higher than the maximum operation temperature

When temperature is lower than maximum operation temperature, the warning sign will disappear and it will return to operation mode

Problem 6: OLED displays "High-Vt"

Check: Is the voltage too high? (over 24V)

Problem 7: OLED displays "Sen-err"

Check 1: Is the soldering iron installed properly?

Check 2: If check 1 passes, then replace the soldering iron tip

Problem 8: The tip doesn't stick to the solder

1. Tip temperature is over 400°C
 2. The soldering side of the tip is not applied with solder properly
 3. Lack of flux during operation
 4. Rub the tip against dry or high sulfur sponge or fabric
 5. Tip touched organic material like plastic, silicone oil or other chemicals
 6. Using impure solder or solder that contains low proportion of tin
-

Problem 9: TS100 return to standby mode during operation

Check: Is the voltage lower than default (10V)

Wait until voltage recovers, it could work normally when the voltage is over 10V

7.1 Standard service

1 year of warranty will be provided for one year, if the damage was not caused by false manipulation by the user. Please contact your retailer for warranty detail

Tips are consumables, once it's used, no replacement will be provided.

7.2 Default Parameter Setting



```

CONFIG - 记事本
文件(F) 编辑(E) 格式(O) 查看(V) 帮助(H)
I_Standby=200      #(100~400)
I_Work=300         #(100~400)
Wait_Time=180     #(50~9999)
Idle_Time=360     #(300~9999)
I_Step=1          #(5~25)
Turn_Off_v=10     #(9~12)
TempShowFlag=0   #(0,1)
ZeroF_Ad=256     #ReadOnly
  
```

Connect TS100 to your PC with USB data cord, OLED will display "CONFIG" and means it's in setting mode. Open config.txt file from the USB drive, set the default parameters.

7.3 Firmware Update



1. Visit www.miniware.com.cn and download the latest TS100 firmware to your PC.
2. Connect TS100 to your PC with USB data cord, meanwhile, press TS100's Button A to enter DFU mode once a "DFU1.0" notice appears on the screen. A virtual disk with 8 serial numbers will appear on your PC.
3. Copy the hex firmware to the root directory of that disk. When the extension of the firmware changes from "hex" to "rdy", disconnect USB and the firmware is upgraded.

7.4 Changing Boot Up Screen

Create your own 96*16 pixel image save as BMP in single color bitmap



Copy the file to soldering iron's USB drive, change file name to "LOGOIN"

Note: When the "LOGOIN.BMP" exists in the USB drive, the boot up logo will be using the file, if the file doesn't exist, it will be using the default logo instead

8.1 Disposal



Do not dispose this product with domestic waste

Handling and recycle: Disposal of the product shall be manipulated according to laws and regulations in your area.

8.2 Statement of Fulfilling FCC Standard



This device fulfills part 15 of the FCC regulations Device must fulfill below 2 conditions:

- (1) Device must not generate interference
- (2) Device must be able to resist any interferences on it, including interferences that could cause dangerous manipulation

8.3 Statement of Fulfilling CE Standard



This is a trademark of Europe Union
This product with CE logo on it fulfills related
Euro Union laws and regulations