



QUICK START GUIDE GET TOGETHER DUO

ATTENTION: PLEASE READ QUICK START GUIDE BEFORE USE

**ATTENTION: PRIÈRE DE LIRE LE GUIDE DE
DÉMARRAGE RAPIDE AVANT UTILISATION**

ATENCIÓN: LEA LA GUÍA DE INICIO RÁPIDO ANTES DE USARLO

BEACHTUNG: VOR DEM GEBRAUCH BITTE DIE SCHNELLSTARTANLEITUNG LESEN

ATTENZIONE: LEGGERE LA GUIDA DI AVVIAMENTO RAPIDO PRIMA DEL USO

OPGELET: VOOR HET GEBRUIK DE SNELSTARTGIDS LEZEN

提示：使用前請閱讀快捷使用說明

주의：사용 전에 빠른 시작 가이드를 읽어 주십시오.

注意：ご使用前にクイックスタートガイドを必ずお読みください。

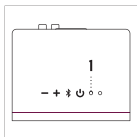
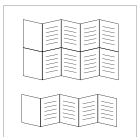
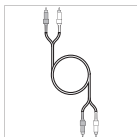
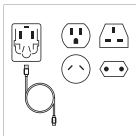
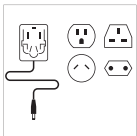

STATUS

- Pairing Mode
- Paired
- AUX mode
- RCA mode

LED INDICATION

- Blinking
- On
- On
- On

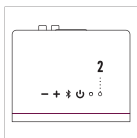

- Full Power
- Charging
- Low Power

- On
- On
- Blinking

COMPONENTS

Composants / Componentes / Komponenten / Component

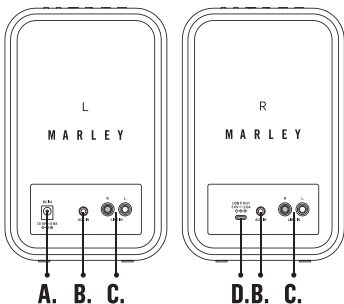

LEGEND

- A. Mains Power Socket
- B. AUX in
- C. RCA Line in
- D. USB-C charging port
- E. Bluetooth LED
- F. Power LED
- G. Volume down / skip backward
- H. Volume up / skip forward
- I. Play/Pause/TWS Connect
- J. Power / Mode select -
BT / AUX IN / RCA line in

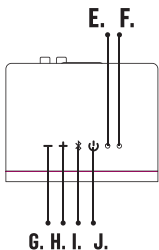

BLUETOOTH®

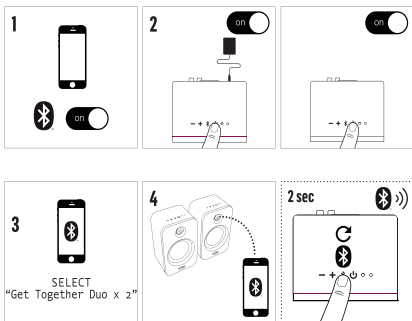

RCA INPUT

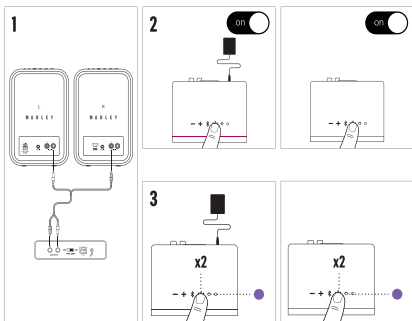

AUX INPUT

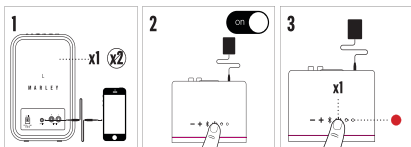

CONTROLS

Les Contrôles / Controlar / Kontrollen / Controlli

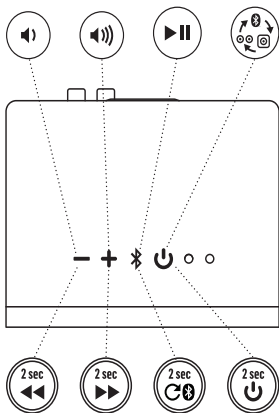

Full instruction and warranty details can be found at

<https://www.thehouseofmarley.com/customer-support/instruction-books>

Para obtener libro de instrucciones, detalles de garantía y excepciones, visite

<https://www.thehouseofmarley.com/customer-support/instruction-books>

Pour les informations complètes et les exceptions, rendezvous sur

<https://www.thehouseofmarley.com/customer-support/instruction-books>

Weitere Informationen und Ausnahmen erhalten Sie hier

<https://www.thehouseofmarley.com/customer-support/instruction-books>

Per maggiori informazioni visitare il sito

<https://www.thehouseofmarley.com/customer-support/instruction-books>

Komplette anvisninger og oplysninger om garanti kan findes på

<https://www.thehouseofmarley.com/customer-support/instruction-books>

Teljes útmutató és garancianyilatkozat:

<https://www.thehouseofmarley.com/customer-support/instruction-books>

Pełna instrukcja i warunki gwarancji są dostępne na stronie:

<https://www.thehouseofmarley.com/customer-support/instruction-books>

Úplné pokyny a detaily záruky nájdete na

<https://www.thehouseofmarley.com/customer-support/instruction-books>

Правила и условия гарантии полностью изложены по адресу

<https://www.thehouseofmarley.com/customer-support/instruction-books>

De volledige handleiding en garantiegegevens kunnen hier worden gevonden:

<https://www.thehouseofmarley.com/customer-support/instruction-books>

Fullstendige instruksjoner og garantidetaler kan finnes på

<https://www.thehouseofmarley.com/customer-support/instruction-books>

Täydelliset ohjeet ja takuu löytyvät osoitteesta

<https://www.thehouseofmarley.com/customer-support/instruction-books>

Fullständiga instruktioner och garantiinformation finns på

<https://www.thehouseofmarley.com/customer-support/instruction-books>

Μπορείτε να βρείτε πλήρεις οδηγίες και λεπτομέρειες για την εγγύηση στη διεύθυνση

<https://www.thehouseofmarley.com/customer-support/instruction-books>

Instruções completas e informações da garantia podem encontrar-se em

<https://www.thehouseofmarley.com/customer-support/instruction-books>

Talimat ve garanti detaylarının tamamına adresinden erişilebilir

<https://www.thehouseofmarley.com/customer-support/instruction-books>

如需查看完整说明和质保详情，请访问

<https://www.thehouseofmarley.com/customer-support/instruction-books>

如需完整說明與保固詳情，請瀏覽

<https://www.thehouseofmarley.com/customer-support/instruction-books>

取扱説明書の全文および保証内容の詳細は、

<https://www.thehouseofmarley.com/customer-support/instruction-books>

をご覧ください。

자세한 설명과 품질보증서 세부사항은

<https://www.thehouseofmarley.com/customer-support/instruction-books>

에서 확인할 수 있습니다.

<https://www.thehouseofmarley.com/customer-support/instruction-books>

QUICK START GUIDE GET TOGETHER DUO

TheHouseofMarley.com



BOB MARLEY™
MARLEY™
BOBMARLEY.COM

©Fifty-Six Hope Road Music Ltd., 2011-2020.
Right of Publicity and Persona Rights.
Fifty-Six Hope Road Music Ltd.

Marley, the Marley logo, Bob Marley and the Bob Marley logo are registered trademarks of Fifty-Six Hope Road Music Limited and any use of such marks by The House of Marley is under license. The Bluetooth® word mark and logos are registered trademarks owned by Bluetooth® SIG, Inc. and any use of such marks by The House of Marley is under license.

COMPLIANCE INFO



Conformité / Conformidad / Beachtung / Conformità / Na-
levingsinformatie / 合規信息 / 규정 준수 정보 / コンプライアンス情報

GET TOGETHER DUO

READ ALL INSTRUCTIONS BEFORE USE AND SAVE THESE INSTRUCTIONS FOR FUTURE REFERENCE.

This equipment has been tested and found to comply with the limits for a Class B digital device, pursuant to part 15 of the FCC Rules. These limits are designed to provide reasonable protection against harmful interference in a residential installation. This equipment generates, uses, and can radiate radio frequency energy and, if not installed and used in accordance with the instructions, may cause harmful interference to radio communications. However, there is no guarantee that interference will not occur in a particular installation. If this equipment does cause harmful interference to radio or television reception, which can be determined by turning the equipment off and on, the user is encouraged to try to correct the interference by one or more of the following measures:

- Reorient or relocate the receiving antenna.
- Increase the separation between the equipment and receiver.
- Connect the equipment into an outlet on a circuit different from that to which the receiver is connected.
- Consult the dealer or an experienced radio/TV technician for help.

This device complies with FCC radiation exposure limits set forth for an uncontrolled environment. This device complies with Part 15 of the FCC Rules. Operation is subject to the following two conditions: (1) this device may not cause harmful interference, and (2) this device must accept any interference received, including interference that may cause undesired operation.

FCC RF EXPOSURE STATEMENT:

This transmitter must not be co-located or operating in conjunction with any other antenna or transmitter. This device complies with FCC radiation exposure limits set forth for an uncontrolled environment.

CAUTION!

Any changes or modifications not expressly approved by the party responsible for compliance could void the user's authority to operate the equipment.

ISED STATEMENT

This device complies with Innovation, Science, and Economic Development Canada license-exempt RSS standard(s). Operation is subject to the following two conditions: (1) this device may not cause interference, and (2) this device must accept any interference, including interference that may cause undesired operation of the device.

This Class B digital apparatus complies with Canadian ICES-003.

ISED RF EXPOSURE STATEMENT:

The device is compliant with RF exposure guidelines, users can obtain Canadian information on RF exposure and compliance.

LE PRÉSENT APPAREIL EST CONFORME

Après examen de ce matériel aux conformité ou aux limites d'intensité de champ RF, les utilisateurs peuvent sur l'exposition aux radiofréquences et la conformité and compliance d'acquérir. les informations correspondantes.

BATTERY REPLACEMENT STATEMENT IN EUROPE

Your Get Together Duo includes a rechargeable battery designed to last the lifetime of the product. In the unlikely event that you should require a replacement battery, please contact Consumer Relations who will supply details of the warranty and out-of-warranty replacement battery service.

BATTERY DIRECTIVE

 This symbol indicates that batteries must not be disposed of in the domestic waste as they contain substances which can be damaging to the environment and health. Please dispose of batteries in designated collection points.

WEEE EXPLANATION

 This marking indicates that this product should not be disposed with other household wastes throughout the EU. To prevent possible harm to the environment or human health from uncontrolled waste disposal, recycle it responsibly to promote the sustainable reuse of material resources.

Hereby, FKA Brands Ltd, declares that this radio equipment is in compliance with the essential requirements and other relevant provisions of Directive 2014/53/EU. A copy of the Declaration of Conformity can be obtained from www.thehouseofmarley.co.uk/declaration-of-conformity

FR GET TOGETHER DUO

LIRE TOUTES LES INSTRUCTIONS AVANT UTILISATION. LES
CONSERVER POUR POUVOIR LES CONSULTER ULTÉRIEUREMENT.

DÉCLARATION ISED

Le présent appareil est conforme aux CNR d'Innovation, Sciences et Développement économique Canada applicables aux appareils radio exempts de licence. L'exploitation est autorisée aux deux conditions suivantes : (1) l'appareil ne doit pas produire de brouillage, et (2) l'utilisateur de l'appareil doit accepter tout brouillage radioélectrique subi, même si le brouillage est susceptible d'en compromettre le fonctionnement.

Cet appareil numérique de classe b est conforme à la norme nmb - 003 du Canada.

REPLACEMENT DES PILES

Notre enceinte Get Together Duo comprend une batterie rechargeable conçue pour durer aussi longtemps que le produit. Dans le cas improbable où vous seriez obligé de recourir à une batterie de rechange, veuillez contacter le Service Clientèle qui vous informera sur la garantie de votre produit et le remplacement hors garantie.

DIRECTIVE RELATIVE AUX PILES ET AUX ACCUMULATEURS



Ce symbole indique que les piles et les accumulateurs ne doivent pas être jetés avec les déchets ménagers car ils contiennent des substances pouvant être préjudiciables pour la santé humaine et l'environnement. Veuillez utiliser les points de collecte mis à disposition pour vous débarrasser des piles et accumulateurs usagés.

EXPLICATION WEEE



Le symbole indique que le produit ne doit pas être éliminé avec les autres déchets ménagers dans toute l'Union Européenne. L'élimination incontrôlée des déchets pouvant porter préjudice à l'environnement ou à la santé humaine, veuillez le recycler de façon responsable. Vous favoriserez ainsi la réutilisation durable des ressources matérielles.

FKA Brands Ltd déclare par la présente que cet équipement radio est conforme aux exigences essentielles et autres dispositions pertinentes de la Directive 2014/53/EU. Pour obtenir un exemplaire de la Déclaration de conformité, s'adresser à

www.thehouseofmarley.co.uk/declaration-of-conformity

NL GET TOGETHER DUO

ALLE INSTRUCTIES LEZEN ALVORENS HET PRODUCT IN GEBRUIK TE NEMEN. DEZE INSTRUCTIES ZORGVULDIG BEWAREN.

BATTERIJEN VERVANGEN

De Get Together Duo komt met een oplaadbare batterij die is ontworpen om net zolang als het product zelf mee te gaan. In het onwaarschijnlijke geval dat u een nieuwe batterij nodig hebt, kunt u contact opnemen met de klantendienst. De medewerkers van de klantendienst zullen u dan informatie geven over het vervangen van batterijen, al dan niet uit hoofde van garantie.

RICHTLIJN INZAKE BATTERIJEN



Dit symbool betekent dat batterijen niet met het huisvuil weggeworpen mogen worden, omdat ze stoffen bevatten die schadelijk kunnen zijn voor het milieu en de gezondheid. Lever batterijen op een aangewezen inzamelpunt in.

UITLEG OVER AEEA



Deze markering geeft aan dat dit product binnen de EU niet met ander huisvuil mag worden weggeworpen. Om eventuele schade aan het milieu of de menselijke gezondheid door het ongecontroleerd wegwerpen van afval te voorkomen, dient dit apparaat op verantwoorde wijze gerecycled te worden om duurzaam hergebruik van materiaalbronnen te bevorderen.

Hierbij verklaart FKA Brands Ltd. dat deze radioapparatuur voldoet aan de essentiële vereisten en andere relevante voorschriften van Directive 2014/53/EU. Een kopie van de conformiteitsverklaring kan worden verkregen via www.thehouseofmarley.co.uk/declaration-of-conformity

IT GET TOGETHER DUO

LEGGERE INTEGRALMENTE LE PRESENTI ISTRUZIONI PRIMA DELL'USO. CONSERVARE LE PRESENTI ISTRUZIONI PER CONSULTAZIONI SUCCESSIVE.

SOSTITUZIONE DELLA BATTERIA

Il tuo sistema Get Together Duo include una batteria ricaricabile la cui durata corrisponde alla vita utile del prodotto. Nella remota eventualità che ti occorra una batteria di ricambio, contatta il Servizio Clienti che ti fornirà i dettagli del servizio relativo alla batteria sostitutiva in garanzia e non in garanzia.

DIRETTIVA RELATIVA ALLE BATTERIE

 Questo simbolo indica che le batterie devono essere smaltite separatamente dai rifiuti domestici poiché contengono sostanze potenzialmente nocive per l'ambiente e la salute umana. Smaltire le batterie negli appositi centri di raccolta.

SPIEGAZIONE DIRETTIVA RAEE

 Questo simbolo indica che il prodotto non deve essere smaltito assieme agli altri rifiuti domestici in tutti i Paesi dell'Unione Europea. Al fine di evitare un eventuale danno ambientale e alla salute umana derivante dallo smaltimento dei rifiuti non controllato, riciclare il prodotto in maniera responsabile per promuovere il riutilizzo sostenibile delle risorse materiali.

Con la presente, FKA Brands Ltd dichiara che l'apparecchiatura radio in oggetto è conforme ai requisiti essenziali e ad altre disposizioni pertinenti della Direttiva 2014/53/EU. È possibile richiedere una copia della Dichiarazione di conformità scrivendo all'indirizzo **www.thehouseofmarley.co.uk/declaration-of-conformity**

SP GET TOGETHER DUO

LEA TODAS LAS INSTRUCCIONES ANTES DE USAR. GUARDE ESTAS INSTRUCCIONES PARA REFERENCIA FUTURA.

REEMPLAZO DE BATERÍAS

Su Get Together Duo incluye una batería recargable diseñada para funcionar durante la vida útil del producto. En el improbable caso de que necesite un reemplazo de batería, comuníquese con Servicios al Cliente, donde le suministrarán los detalles del servicio de reemplazo de baterías con garantía y sin garantía.

DIRETTIVA RELATIVA A LAS PILAS

 Este símbolo indica que las pilas no se deben eliminar con la basura doméstica ya que contienen sustancias que pueden ser perjudiciales para el medio ambiente y la salud. Deshágase de las pilas en los puntos de recogida que existen para ese fin.

EXPLICACIÓN RAEE

 Este símbolo indica que este artículo no se debe tirar a la basura con otros residuos domésticos en ningún lugar de la UE. A fin de prevenir los efectos perjudiciales que la eliminación sin control de los residuos puede tener sobre el medio ambiente o la salud de las personas, le rogamos que los recicle de forma responsable para fomentar la reutilización sostenible de los recursos materiales.

Por la presente, FKA Brands Ltd declara que este dispositivo de radio está en conformidad con los requisitos esenciales y otras disposiciones relevantes de la directiva 2014/53/EU. Si desea una copia de la

declaración de conformidad, solicítela a www.thehouseofmarley.co.uk/declaration-of-conformity

FIN GET TOGETHER DUO

LUE KAIKKI OHJEET ENNEN KÄYTTÖÄ. SÄILYTÄ NÄMÄ OHJEET TULEVAA TARVETTA VARTEN. TÄRKEÄT VAROTOIMENPITEET:

AKUN VAIHTO

Get Together Duo-kaiuttimessa on ladattava akku, joka on suunniteltu kestäämään yhtä pitkään kuin itse kaiutin. Jos akku kuitenkin täytyy vaihtaa, ota yhteyttä asiakaspalveluun, mistä saat tiedot takuun piiriin kuuluvan akun ja takuun ulkopuolisen akun korvaavasta toimituspalvelusta.

AKKUJA KOSKEVA DIREKTIIVI

 Tämä symboli tarkoittaa, että akkuja ei saa hävittää talousjätteiden mukana, koska ne sisältävät aineita, jotka voivat olla vahingollisia ympäristölle ja terveydelle. Vie akut niille tarkoitettuihin keräyspisteisiin.

WEEE-SELITYS

 Tämä merkki tarkoittaa, että tätä tuotetta ei saa hävittää muiden talousjätteiden mukana missään EUmaassa. Kontrolloimattomasta jätteiden hävittämisestä mahdollisesti aiheutuvien ympäristöhaittojen tai terveysvaarojen estämiseksi hävitä tämä tuote vastuullisesti edistääksesi materiaalivarojen uudelleenkäyttöä.

FKA Brands Ltd. vakuuttaa, että tämä radiolaite on direktiivin 2014/53/EU vaatimusten ja muiden siihen liittyvien säädösten mukainen. Kopion vaatimustenmukaisuusvakuutuksesta voi tilata lähettämällä sähköpostia osoitteeseen www.thehouseofmarley.co.uk/declaration-of-conformity

DE GET TOGETHER DUO

LESEN SIE SICH VOR DER BENUTZUNG ALLE HINWEISE GUT DURCH. BEWAHREN SIE DIESE HINWEISE GUT AUF.

BATTERIEWECHSEL

Ihr Get Together Duo enthält eine wiederaufladbare Batterie, die für die gesamte Lebensdauer der Lautsprecher halten sollte. In dem unwahrscheinlichen Fall, dass Sie die Batterie ersetzen müssen, wenden Sie sich bitte an unseren Kundendienst, der Sie über die Einzelheiten zum Ersatz der Batterie im Garantiefall und außerhalb der Garantie informieren wird.

BATTERIE RICHTLINIE

 Dieses Symbol weist darauf hin, dass die Batterien nicht mit dem gewöhnlichen Hausmüll entsorgt werden dürfen, da sie Stoffe enthalten, die sich auf Umwelt und Gesundheit schädlich auswirken können. Entsorgen Sie die Batterien bitte an den hierfür vorgesehenen Sammelstellen.

WEEE-ERKLÄRUNG

 Diese Kennzeichnung weist darauf hin, dass dieses Produkt innerhalb der EU nicht mit anderem Hausmüll entsorgt werden soll. Damit durch unkontrollierte Abfallentsorgung verursachte mögliche Umwelt- oder Gesundheitsschäden verhindert werden können, entsorgen Sie dieses

Produkt bitte ordnungsgemäß und fördern Sie damit eine nachhaltige Wiederverwendung der Rohstoffe.

Hiermit erklärt die FKA Brands Ltd., dass dieses Funkgerät in Übereinstimmung mit den wesentlichen Anforderungen und anderen entsprechenden Bestimmungen der Richtlinie 2014/53/EU geliefert wird. Eine Kopie der Konformitätserklärung ist über www.thehouseofmarley.co.uk/declaration-of-conformity

TR GET TOGETHER DUO

KULLANMADAN ÖNCE TÜM TALİMATLARI OKUYUN. BU TALİMATLARI DAHA SONRA BAŞVURMAK ÜZERE SAK.

PİL DEĞİŞTİRME

Get Together Duo'ınızda, ürünün ömrü boyunca yetecek şekilde tasarlanmış şarj edilebilir pil bulunmaktadır. Pili değiştirmenizin gerekmesi durumunda, lütfen, size garanti kapsamı ve garanti kapsamı dışında olan pil değiştirme hizmet detaylarını verecek Müşteri Hizmetleriyle temasa geçin.

PİL DİREKTİFİ

 Bu sembol, çevreye ve sağlığa karşı zararlı olabilen maddeler içerebileceği için pillerin ev atığıyla atılmaması gerektiği gösterir. Lütfen, pilleri belirtilen toplama noktalarına atın.

WEEE AÇIKLAMASI

 Bu işaret bu ürünün AB genelinde diğer ev atıklarıyla birlikte atılmaması gerektiğini belirtir. Kontrolsüz atığın çevre veya insan sağlığına olası zararları engellemek için sorumlu bir şekilde geri dönüştürülmesini ve malzeme kaynaklarının sürdürülebilir şekilde yeniden kullanılmasını sağlayın.

İş bu vesileyle, FKA Brands Ltd, bu telsiz ekipmanının 2014/53/EU Yönergesinin temel gereksinimleri ve diğer ilgili hükümleriyle uyumlu olduğunu beyan eder. Uygunluk Beyanı'nın bir kopyası www.thehouseofmarley.co.uk/declaration-of-conformity

SV GET TOGETHER DUO

LÄS ALLA INSTRUKTIONERNA FÖRE ANVÄNDNING. SPARA DESSA INSTRUKTIONER FÖR FRAMTIDA REFERENS.

BYTE AV BATTERI

Din Get Together Duo inkluderar ett återuppladdningsbart batteri som är designat att vara under produktens livslängd. Om du osannolikt skulle behöva byta batteriet, kontakta kundtjänst som kommer att ge dig information om garantin och batteribyttjänst utanför garantin.

BATTERIFÖRESKRIFT

 Denna symbol indikerar att batterier inte får avyttras bland hushållssopor eftersom de innehåller substanser som kan skada miljön och hälsan. Avyttra batterier endast vid designerade samlingspunkter.

WEEE-FÖRKLARING

 Denna markering indikerar att denna produkt inte får avyttras med

annat hushållsavfall inom EU. För att förhindra möjlig skada på miljö eller person från okontrollerat avfallsavyttrande, återvinn på ansvarsfullt vis för att främja det fortsatta återanvändandet av materialresurser.

Härmed deklarerar FKA Brands Ltd att denna radioutrustning är förenlig med nödvändiga krav och andra relevanta bestämmelser i direktivet 2014/53/EU. En kopia av förenlighetsdeklarationen kan erhållas från www.thehouseofmarley.co.uk/declaration-of-conformity

RU GET TOGETHER DUO

ПРОЧИТАЙТЕ ВСЕ ИНСТРУКЦИИ ПЕРЕД ИСПОЛЬЗОВАНИЕМ. СОХРАНИТЕ ЭТИ ИНСТРУКЦИИ ДЛЯ ДАЛЬНЕЙШЕГО ИСПОЛЬЗОВАНИЯ.

ЗАМЕНА БАТАРЕЙКИ

Динамик Get Together Duo содержит аккумулятор, срок службы которого соответствует сроку службы продукта. Если возникнет необходимость в замене аккумулятора, что маловероятно, обратитесь в службу поддержки. Ее персонал предоставляет гарантийное обслуживание и осуществляет замену аккумуляторов (на замену аккумуляторов действие гарантии не распространяется).

ИНСТРУКЦИИ К БАТАРЕЯМ

 Данный символ означает, что батареи не следует утилизировать совместно с бытовым мусором, поскольку они содержат вещества, способные нанести вред окружающей среде и здоровью. Утилизируйте батареи в специально предназначенных для этого приемных пунктах.

ПОЯСНЕНИЕ WEEE

 Данная маркировка означает, что в странах Европы не допускается утилизировать прибор вместе с другими бытовыми отходами. Чтобы не нанести ущерба окружающей среде и здоровью населения в результате неверной утилизации отходов, прибор следует сдать на переработку, чтобы обеспечить экологичное повторное использование материальных ресурсов.

Компания FKA Brands Ltd настоящим подтверждает соответствие данного радиооборудования основным требованиям и другим применимым положениям Директивы 2014/53/EU. Копия Декларации соответствия можно получить по электронному адресу:

www.thehouseofmarley.co.uk/declaration-of-conformity

DK GET TOGETHER DUO

LÆS HELE VEJLEDNINGEN IGENNEM FØR BRUG. GEM DENNE VEJLEDNING TIL SENERE BRUG.

UDSKIFTNING AF BATTERI

Din Get Together Duo indeholder et genopladeligt batteri, som er beregnet til at vare hele produktets levetid. Hvis det usandsynlige skulle ske, og du har brug for et nyt batteri, bedes du kontakte Kundeservice, som kan informere dig om udskiftning af batteri, både så længe garantien gælder og senere.

BATTERIDIREKTIV

 Dette symbol indikerer, at batterier ikke må bortskaffes med husholdningsaffald, da de indeholder stoffer, der kan være miljø- og helbredsskadelige. Bortskaf venligst batterier på udpegede indsamlingssteder.

WEEE FORKLARING

 Denne afmærkning angiver, at dette produkt ikke må bortskaffes med andet husholdningsaffald inden for EU. For at forhindre mulig skade for miljøet eller menneskers sundhed på grund af ukontrolleret affaldsbortskaffelse, skal det genanvendes på ansvarlig vis for at fremme den bæredygtige genanvendelse af materielle ressourcer.

FKA Brands Ltd erklærer hermed, at dette radioudstyr efterlever de essentielle krav og andre relevante bestemmelser i Direktiv 2014/53/EU. En kopi af Overensstemmelseserklæringen kan fås hos www.thehouseofmarley.co.uk/declaration-of-conformity

NO GET TOGETHER DUO

LES ALLE INSTRUSJONENE FØR BRUK. TA VARE PÅ DISSE INSTRUKSJONENE FOR FREMTIDIG REFERANSE.

SKIFTE BATTERI

Get Together Duo enheten din har et oppladbart batteri som er konstruert for å vare like lenge som produktet. Skulle det uforutsette skje at du trenger et nytt batteri, ta kontakt med kundetjenesten som vil gi deg informasjon om garantien og utskifting-service for batteri når garantien har utgått.

BATTERIDIREKTIV

 Dette symbolet indikerer at batteriene ikke må kastes sammen med vanlig husholdningsavfall da de inneholder substanser som kan skade miljøet og helsen. Vær vennlig å kaste batterier i angitte oppsamlingspunkter.

WEEE FORKLARING

 Denne merkingen indikerer at innen EU skal dette produktet ikke kastes sammen med annet husholdningssoppel. For å forebygge mulig skade på miljøet eller menneskelig helse forårsaket av ukontrollert avfallstømming, skal produktet gjenvinnes ansvarlig for å støtte holdbar gjenbruk av materialressurser.

FKA Brands Ltd, erklærer herved at dette radioutstyret samsvarer med nødvendige krav og andre relevante forholdsregler i direktiv 2014/53/EU. En kopi av konformitetserklæringen er tilgjengelig fra www.thehouseofmarley.co.uk/declaration-of-conformity

EL GET TOGETHER DUO

ΔΙΑΒΑΣΤΕ ΟΛΕΣ ΤΙΣ ΟΔΗΓΙΕΣ ΠΡΙΝ ΤΗ ΧΡΗΣΗ. ΦΥΛΑΞΤΕ ΑΥΤΕΣ ΤΙΣ ΟΔΗΓΙΕΣ ΓΙΑ ΜΕΛΛΟΝΤΙΚΗ ΑΝΑΦΟΡΑ.

ΑΝΤΙΚΑΤΑΣΤΑΣΗ ΜΠΑΤΑΡΙΑΣ

Το ηχείο Get Together Duo περιλαμβάνει μια επαναφορτιζόμενη μπαταρία ειδικά σχεδιασμένη ώστε να διαρκεί για όλη την ωφέλιμη ζωή του προϊόντος. Στην απίθανη περίπτωση που θα χρειαστείτε

μπαταρία αντικατάστασης, επικοινωνήστε με την Εξυπηρέτηση Πελατών, η οποία θα σας δώσει λεπτομέρειες για αντικατάσταση της μπαταρίας εντός και εκτός εγγύησης.

ΟΔΗΓΙΑ ΓΙΑ ΤΙΣ ΜΠΑΤΑΡΙΕΣ

 Το σύμβολο αυτό υποδεικνύει ότι οι μπαταρίες δεν πρέπει να απορρίπτονται μαζί με οικιακά απορρίμματα, καθώς περιέχουν ουσίες που μπορεί να είναι επιβλαβείς για το περιβάλλον και την υγεία. Απορρίψτε τις μπαταρίες στα καθορισμένα σημεία συλλογής.

ΕΠΕΞΗΓΗΣΗ ΑΗΘΕ

 Αυτή η σήμανση επισημαίνει ότι αυτό το προϊόν δεν πρέπει να απορρίπτεται με άλλα οικιακά απόβλητα σε όλη την ΕΕ. Για να μην προκληθεί ζημιά στο περιβάλλον ή στην υγεία λόγω μη ελεγχόμενης απόρριψης αποβλήτων, ανακυκλώστε το υπεύθυνα, προάγοντας τη βιώσιμη επαναχρησιμοποίηση των υλικών πόρων.

Με το παρόν, η FKA Brands Ltd δηλώνει ότι αυτός ο ασύρματος εξοπλισμός συμμορφώνεται με τις ουσιαστικές απαιτήσεις και τις άλλες σχετικές προβλέψεις της Οδηγίας 2014/53/ΕΕ. Μπορείτε να αποκτήσετε ένα αντίγραφο της Δήλωσης Συμμόρφωσης αν επικοινωνήσετε με τη διεύθυνση www.thehouseofmarley.co.uk/declaration-of-conformity

CZ GET TOGETHER DUO

PŘED POUŽITÍM ZAŘÍZENÍ SI PŘEČTĚTE VŠECHNY POKYNY. POKYNY USCHOVEJTE PRO BUDOUCÍ NAHLÉDNUTÍ.

VÝMĚNA BATERIE

Jednotka Get Together Duo obsahuje nabíjecí baterii, která by měla být funkční po celou dobu životnosti produktu. Pokud by však bylo třeba baterii vyměnit, kontaktujte zákaznickou službu, která vám poskytne podrobné informace o záruční a mimozáruční výměně baterie.

POKYNY K BATERII

 Tento symbol znamená, že baterie nesmí být likvidována vyhozením do domácího odpadu, protože obsahuje látky, jež mohou poškodit životní prostředí a zdraví. Za účelem likvidace baterii odevzdejte na určeném sběrném místě.

VYSVĚTLENÍ OEEZ

 Tato značka udává, že výrobek nesmí být na území EU vyhazován s běžným domácím odpadem. Pro prevenci možného znečištění životního prostředí a újmě na zdraví osob nekontrolovaným odpadem recyklujte výrobek odpovědným způsobem.

Společnost FKA Brands Ltd tímto prohlašuje, že toto rádiové vybavení je ve shodě se základními požadavky a dalšími relevantními ustanoveními směrnice 2014/53/EU. Kopii prohlášení o shodě získáte na adrese www.thehouseofmarley.co.uk/declaration-of-conformity

HU GET TOGETHER DUO

HASZNÁLAT ELŐTT OLVASSA EL AZ UTASÍTÁSOKAT, ÉS A KÉSŐBBI HASZNÁLATHOZ TEGYE EL EZEKET.

AZ AKKUMLÁTOR CSERÉJE

A Get Together Duo újratölthető akkumulátort tartalmaz, amit úgy

terveztek, hogy kitarson a termék teljes élettartamáig. Ha mégis szüksége lenne egy csereakkumulátorra, lépjen kapcsolatba az Ügyfélszolgálattal, ahol tájékoztatást adnak a jótállásban foglalt és a jótálláson kívül eső akkumulátorcserével kapcsolatban.

ELEMEKRE VONATKOZÓ IRÁNYELV

 Ez a szimbólum azt jelzi, hogy az elemek nem dobhatók háztartási hulladék közé, mivel olyan anyagokat tartalmaznak, amelyek károsak lehetnek a környezetre és az egészségre. Kérjük, vigye a használt elemeket a kijelölt gyűjtőhelyre.

WEEE-MAGYARÁZAT

 Ez a jelölés azt jelzi, hogy ezt a terméket az Európai Unióban nem szabad a háztartási hulladék közé dobni. Az ellenőrizetlen hulladékkezelésből származó környezeti vagy egészségügyi kár elkerülése végett, és a tárgyi készletek fenntartható kezelése jegyében felelősségteljesen hasznosítsa újra.

A FKA Brands Ltd. kijelenti, hogy ez a rádióberendezés eleget tesz a 2014/53/EU irányelv szükséges követelményeinek és egyéb vonatkozó rendelkezéseinek. A Megfelelőségi nyilatkozat másolatát a www.thehouseofmarley.co.uk/declaration-of-conformity

PT GET TOGETHER DUO

LEIA TODAS AS INSTRUÇÕES ANTES DE UTILIZAR. CONSERVE ESTAS INSTRUÇÕES PARA REFERÊNCIA FUTURA.

SUBSTITUIÇÃO DA BATERIA

O seu Get Together Duo inclui uma bateria vitalícia recarregável. Na hipótese pouco provável de necessitar de substituir a bateria, contacte o Serviço de Apoio ao Cliente, que lhe irá disponibilizar informações sobre o serviço de substituição da bateria ao abrigo da garantia e fora da cobertura da garantia.

INSTRUÇÕES RELATIVAMENTE ÀS PILHAS

 Este símbolo indica que as pilhas não podem ser eliminadas juntamente com o lixo doméstico, dado que contêm substâncias que podem ser prejudiciais para o meio ambiente e a saúde. As pilhas devem ser eliminadas nos pontos de recolha designados.

EXPLICAÇÃO DA REEE

 Esta marcação indica que o produto não deve ser eliminado juntamente com outros resíduos domésticos em toda a UE. Para impedir possíveis danos ambientais ou à saúde humana resultantes de uma eliminação não controlada dos resíduos, este produto deverá ser reciclado de forma responsável de modo a promover a reutilização sustentável dos recursos materiais.

Desta forma, o FKA Brands Ltd, declara que este equipamento de rádio está em conformidade com os requisitos essenciais outras provisões relevantes da Diretiva 2014/53/EU. É possível obter uma cópia da Declaração de Conformidade através do www.thehouseofmarley.co.uk/declaration-of-conformity

SK GET TOGETHER DUO

PRED POUŽITÍM ZARIADENIA SI PREČÍTAJTE VŠETKY POKYNY. POKYNY USCHOVAJTE NA NAHLIADNUTIE V BUDÚCNOSTI.

VÝMENA BATÉRIE

V reproduktore Get Together Duo sa nachádza vymeniteľná batéria navrhnutá tak, aby jej životnosť zodpovedala životnosti produktu. Ak sa stane (hoci je to nepravdepodobné), že budete potrebovať náhradnú batériu, obráťte sa na pracovníkov oddelenia služieb zákazníkom, ktorí vám poskytnú podrobné informácie o servise náhradnej batérie vykonávanom v rámci záručnej lehoty a aj po jej skončení.

POKYNY OHĽADNE BATÉRIE

 Tento znak znamená, že batérie sa nesmú likvidovať spolu s domácim odpadom, pretože obsahujú látky, ktoré môžu znečistiť životné prostredie alebo poškodiť zdravie. Batérie likvidujte v strediskách určených pre zber odpadu.

WEEE POPIS

 Tento symbol znamená, že výrobok by sa v rámci celej EÚ nemá vyhadzovať do domáceho odpadu. Aby nedošlo k možnému znečisteniu životného prostredia alebo poškodeniu zdravia v dôsledku nekontrolovaného odpadu, je potrebné pristupovať k recyklovaniu zodpovedne a propagovať tak opätovné použitie zdrojových materiálov.

Spoločnosť FKA Brands Ltd. týmto vyhlasuje, že toto rádiové zariadenie je v súlade so základnými požiadavkami a ďalšími relevantnými ustanoveniami Smernice 2014/53/EÚ. Kópiu vyhlásenia o zhode získate na adrese www.thehouseofmarley.co.uk/declaration-of-conformity

PL GET TOGETHER DUO

PRZED UŻYCIEM NALEŻY PRZECZYTAĆ CAŁĄ INSTRUKCJĘ. INSTRUKCJĘ NALEŻY ZACHOWAĆ NA PRZYSZŁOŚĆ.

WYMIANA BATERII

Głośnik Get Together Duo został wyposażony w baterie wielokrotnego ładowania o żywotności porównywalnej z żywotnością produktu. W przypadku wystąpienia sytuacji wymagającej wymianę baterii należy skontaktować się działem obsługi klienta, który zapewni informacje dotyczące gwarancji oraz usługi wymiany baterii nieobjętej gwarancją.

DYREKTYWA DOT. BATERII

 Ten symbol oznacza, że baterii nie można wyrzucać wraz z odpadami domowymi, ponieważ baterie zawierają substancje, które mogą być szkodliwe dla środowiska oraz zdrowia. Baterie należy dostarczyć do wyznaczonych punktów zbiórki.

OBJAŚNIENIE WEEE

 Ten znak wskazuje, że na obszarze UE przyrządu nie wolno pozbywać się wyrzucając do śmieci domowych. Aby chronić środowisko i zdrowie, którym zagraża nieodpowiednia utylizacja odpadów, przyrząd należy recyklingować, aby umożliwić odzysk materiałów, z których został wykonany.

Niniejszym firma FKA Brands Ltd oświadcza, że to urządzenie radiowe jest zgodne z podstawowymi wymaganiami oraz innymi właściwymi postanowieniami Dyrektywy 2014/53/EU. Kopię Deklaracji zgodności można uzyskać pod

www.thehouseofmarley.co.uk/declaration-of-conformity

BG GET TOGETHER DUO

ПРОЧЕТЕТЕ ВСИЧКИ ИНСТРУКЦИИ ПРЕДИ УПОТРЕБА И ГИ ЗАПАЗЕТЕ ЗА БЪДЕЩА СПРАВКА.

ПРЕДУПРЕЖДЕНИЕ: БАТЕРИИТЕ (КУТИЯТА С БАТЕРИИ ИЛИ ПОСТАВЕНИТЕ БАТЕРИИ) НЕ ТРЯБВА ДА СЕ ИЗЛАГАТ НА ПРЕКАЛЕНО ЗАТОПЛЯНЕ КАТО СЛЪНЧЕВА ТОПЛИНА, ОГЪН ИЛИ ДРУГИ ПОДОБНИ. ВНИМАНИЕ: ОПАСНОСТ ОТ ЕКСПЛОЗИЯ АКО БАТЕРИЯТА НЕ Е ПОСТАВЕНА ПРАВИЛНО. ЗАМЕНЕТЕ ЕДИНСТВЕНО СЪС СЪЩИЯ ИЛИ С ПОДОБЕН ВИД.

ЗАМЯНА НА БАТЕРИЯТА:

Вашият Get Together Duo включва зареждащи се батерии, предназначени да издържат през целия живот на продукта. В малко вероятния случай, когато се наложи замяна на батерията, моля свържете се с отдела за клиентско обслужване, който ще Ви осигури информация за гаранцията и услугата за замяна на батерията извън гаранция.

ДИРЕКТИВА ЗА БАТЕРИЯТА

 Този символ показва, че батериите не трябва да се изхвърлят с битовите отпадъци, защото съдържат вещества, които може да са опасни за околната среда и за здравето. Моля, изхвърляйте батериите на предназначените за тази цел места.

ОБЕО ОБЯСНЕНИЕ

 Това маркиране показва, че този продукт не трябва да се изхвърля с други битови отпадъци в границите на ЕС. За предотвратяване на евентуална щета за околната среда или за човешкото здраве поради неконтролно изхвърляне на боклука, рециклирайте го отговорно, за да съдействате за екологичната многократна употреба на материалните ресурси.

С настоящето, FKA Brands Ltd, декларира, че това радиосъоръжение е в съответствие на основните изисквания и на други необходими условия на Директива 2014/53/EU. Копие от Декларацията за съответствие може да бъде получено от

www.thehouseofmarley.co.uk/declaration-of-conformity

RO GET TOGETHER DUO

CITIȚI TOATE INSTRUCȚIUNILE ÎNAINTE DE UTILIZARE ȘI PĂSTRAȚI-LE PENTRU A LE CONSULTA ÎN VIITOR.

ÎNLOCUIREA BATERIILOR

Difuzorul Get Together Duo include un acumulator conceput să reziste pe toată durata de viață a produsului. În cazul improbabil în care ați fi obligat să înlocuiți acumulatorul, contactați Serviciul Clienți care vă va informa cu

privire la garanția produsului dumneavoastră și la înlocuirea acumulatorului după expirarea garanției.

DIRECTIVA PRIVIND BATERIILE ȘI ACUMULATORII

 Acest simbol indică faptul că nu este permis să se arunce bateriile și acumulatorii cu deșeurile menajere deoarece conțin substanțe care pot dăuna mediului și sănătății. Vă recomandăm să predați bateriile și acumulatorii uzați la punctele de colectare puse la dispoziție.

EXPLICAȚIA DEEE

 Acest simbol indică faptul că acest produs nu trebuie eliminat împreună cu alte deșeuri menajere pe teritoriul UE. Pentru a preveni posibile prejudicii asupra mediului sau sănătății umane din cauza eliminării necontrolate a deșeurilor, reciclați-l cu responsabilitate pentru a favoriza reutilizarea durabilă a resurselor materiale.

FKA Brands Ltd declară că acest dispozitiv radio este în conformitate cu cerințele esențiale și alte prevederi relevante ale Directivei 2014/53/EU. Un exemplar al Declarației de conformitate poate obținut de la www.thehouseofmarley.co.uk/declaration-of-conformity

AR GET TOGETHER DUO

اقرأ كل الإرشادات وافهمها قبل استخدام المنتج بعناية والاحتفاظ بها للرجوع إليها.

استبدال البطارية

يحتوي نظام Get Together Duo على بطارية قابلة لإعادة الشحن مصممة خصيصًا للاستمرار على مدار عمر المنتج. في حالة احتياجك لبطارية بديلة، وهو أمر بعيد الاحتمال، يرجى الاتصال بخدمة العملاء حيث يمكنك الحصول على التفاصيل حول خدمة استبدال البطارية داخل الضمان أو خارجه.

تعليمات البطارية

 يشير هذا الرمز إلى أن البطاريات ينبغي عدم التخلص منها مع سائر المخلفات المنزلية لأنها تحتوي على مواد قد تضر بالبيئة والصحة. يرجى التخلص من البطاريات في أماكن التجميع المخصصة.

مخلفات الأجهزة الكهربائية / الإلكترونية

 يشير هذا الرمز إلى أن المنتج ينبغي عدم التخلص منه مع سائر المخلفات المنزلية الأخرى في جميع أنحاء الاتحاد الأوروبي. لتفادي احتمال وقوع الضرر على البيئة أو الصحة البشرية بسبب التخلص من النفايات بطرق غير خاضعة للضوابط، يرجى إعادة تدويرها على نحو مسؤول لتعزيز إعادة الاستخدام المستدام العربية تقر FKA Brands Ltd بموجب أن هذا الجهاز اللاسلكي يأتي متوافقاً مع المتطلبات اللازمة وغيره من الأحكام ذات الصلة من الأمر الإرشادي 2014/53/EU. ويمكن الحصول على نسخة من إعلان المطابقة على

www.thehouseofmarley.co.uk/declaration-of-conformity

CN GET TOGETHER DUO

使用之前請閱讀所有指南並妥善保存以備未來參考

更換電池

Get Together Duo 隨帶一個可充電電池。設備使用期內無需更換電池。當您因某種特殊原因需要更換電池時，請與客服聯繫。客服人員將為您提供詳盡的保修期內和保修期後更換電池的服務說明。

廢舊電池的處理

 此符號表示電池不得與家庭廢物一起丟棄，因為電池含有對環境和健康有害的成分。請將廢舊電池送至指定的收集處。

歐共體廢棄電子電器設備指南(WEEE)解釋

 此標識表示在歐共體內本產品不得與家庭勒色一起丟棄。無控制的勒色丟棄有害環境或健康，必須避免。請盡力回收廢舊設備，使其持續得以再生利用。

FKA分銷有限公司在此聲明，此無線設備符合2014/53/EU指南的基本要求和其它相關條款。請訪問www.thehouseofmarley.co.uk/declaration-of-conformity以獲取合規聲明的副本。

NCC WARNING MESSAGE

低功率電波輻射性電機管理辦法

第十二條 經型式認證合格之低功率射頻電機，非經許可，公司、商號或使用者均不得擅自變更頻率、加大功率或變更原設計之特性及功能。

第十四條 低功率射頻電機之使用不得影響飛航安全及干擾合法通信；經發現有干擾現象時，應改善至無干擾時方得繼續使用。
前項合法通信，指依電信法規定作業之無線電通信。

低功率射頻電機須忍受合法通信或工業、科學及醫療用電波輻射性電機設備之干擾。

ID GET TOGETHER DUO

BACA SEMUA PETUNJUK SEBELUM PENGGUNAAN DAN SIMPAN PETUNJUK INI UNTUK RUJUKAN DI MASA MENDATANG.

PENGGANTIAN BATERAI

Get Together Duo Anda mencakup baterai isi ulang yang dirancang untuk bisa dipakai selama masa pakai produk. Apabila Anda memerlukan baterai pengganti, hubungi Layanan Pelanggan yang akan memberikan detail tentang layanan baterai pengganti garansi dan di luar garansi.

ARAHAN BATERAI

 Simbol ini menunjukkan bahwa baterai tidak boleh dibuang bersama sampah rumah tangga karena mengandung zat yang dapat merusak lingkungan dan kesehatan. Buang baterai di tempat pengumpulan yang telah ditentukan.

PENJELASAN WEEE

 Tanda ini menunjukkan bahwa produk ini tidak boleh dibuang bersama sampah rumah tangga lain di seluruh UE. Untuk mencegah kemungkinan bahaya pada lingkungan atau kesehatan manusia dari pembuangan limbah yang tidak terkendali, daur ulang produk ini secara bertanggung jawab untuk mempromosikan penggunaan kembali sumber daya bahan secara berkelanjutan. FKA Brands Ltd dengan ini menyatakan bahwa peralatan radio ini mematuhi persyaratan penting dan ketentuan relevan lainnya dari Arahan 2014/53/EU. Salinan Pernyataan Kepatuhan bisa diperoleh dari www.thehouseofmarley.co.uk/declaration-of-conformity

사용 전에 모든 지침을 읽고 이후 참조할 수 있도록 보관해 두십시오.

배터리 교체

GET TOGETHER DUO에는 제품의 수명을 지속하도록 설계된 재충전 배터리가 포함되어 있습니다. 드물지만 배터리를 교체해야 하는 경우에는 고객 서비스 부서에 문의하여 보증 및 보증 외 배터리 교체 서비스에 대한 상세 정보를 확인하십시오.

배터리 지침

 이 기호는 배터리가 환경 및 건강에 해를 끼칠 수 있는 물질을 함유하고 있으므로 가정용 쓰레기로 폐기해서는 안 된다는 것을 나타냅니다. 배터리를 지정된 수거 장소에 버리십시오.

WEEE 설명

 이 표시는 이 제품을 EU 전역에서 다른 가정용 쓰레기와 함께 폐기해서는 안 된다는 것을 나타냅니다. 통제되지 않은 쓰레기 폐기로 인해 환경이나 인체에 해를 끼치지 않도록 하려면 책임감을 갖고 재활용하여 물질 자원의 지속 가능한 재사용을 촉진하십시오.

FKA BRANDS LTD는 이 무선 장비가 DIRECTIVE 2014/53/EU의 필수 요건 및 기타 관련 조항을 준수함을 선언합니다. 적합성 선언서(DECLARATION OF CONFORMITY) 사본은

www.thehouseofmarley.co.uk/declaration-of-conformity에서 얻을 수 있습니다.

제12조 DGT의 허가 없이 회사, 기업 또는 사용자는 주파수를 변경하거나 송전을 개선하거나 원래 특성은 물론 성능을 공인된 저전력 무선 주파수 장치로 바꿀 수 없습니다.

제14조 저전력 무선 주파수 장치는 항공기 보안에 영향을 미치거나 합법적 통신을 간섭해서는 안 됩니다. 이를 발견한 경우 사용자는 간섭을 하지 않을 때까지 즉시 작동을 중지해야 합니다. 앞서 말한 합법적 통신이라 함은 무선 통신이 전기통신법에 따라 작동된다는 뜻입니다. 저전력 무선 주파수 장치는 합법적 통신 또는 ISM 전파 방출 장치의 간섭에 민감해야 합니다.



To prevent possible hearing damage, do not listen at high volume levels for long periods. Full instruction and warranty details can be found at <http://www.thehouseofmarley.com/instructionbooks>.

Con el fin de evitar lesiones auditivas, se aconseja no escuchar a un volumen excesivamente alto durante un periodo prolongado. Para ver los detalles completos y las excepciones, consulte <http://www.thehouseofmarley.com/instructionbooks>

Afin d'éviter tout dommage auditif possible, ne pas écouter à un volume sonore élevé pendant une période prolongée. Pour les informations complètes et les exceptions, rendez-vous sur <http://www.thehouseofmarley.com/instructionbooks>

Um mögliche Hörschäden zu vermeiden, stellen Sie die Lautstärke nicht über einen längeren Zeitraum sehr hoch ein. Weitere Informationen und Ausnahmen erhalten Sie hier <http://www.thehouseofmarley.com/instructionbooks>

Per evitare possibili danni all'udito, non ascoltare audio a livelli elevati di volume per lunghi periodi. Per tutti i dettagli e le eccezioni, visitare il sito <http://www.thehouseofmarley.com/instructionbooks>

Marley and the Marley logo are registered trademarks of Fifty-Six Hope Road Music Limited and the use of such marks by House of Marley is under license. The Bluetooth® word mark and logos are registered trademarks owned by Bluetooth® SIG, Inc. and any use of such marks by The House of Marley is under license.

Operating frequency bands: 2402 – 2480MHz
CE BT Max Power Transmitted Power:
LEFT: EM-JA019L = 2.98dBm
RIGHT: EM-JA019R = 4.18dBm

DISTRIBUTED BY:
House of Marley, LLC
3000 N Pontiac Trail
Commerce Township, MI 48390 USA

Distributed in Europe by FKA Brands Ltd.,
Somerville Business Park, Five Oak Green Rd,
Tonbridge, Kent TN11 0GP, UK

QS-EMJA019

 **EM-JA019**
© 2020 House of Marley, LLC.
All Rights Reserved.



