

# EMC TEST REPORT

**Application No.** : LH-220101040391  
**Applicant** : MyOnlineStores (Pty) Ltd.  
**Equipment Under Test (EUT)**  
**EUT Name** : Wifi Repeater  
**Model No.** : WR  
**Serial No.** : See Page 4  
**Trademark** : N/A  
**Receipt Date** : 2022-1-10  
**Test Date** : 2022-1-10 to 2022-1-20  
**Issue Date** : 2022-1-22  
**Standards** : ETSI EN301489-1V2.2.3 (2019-11)  
ETSI EN301489-17 V3.2.4 (2020-09)  
**Conclusions** : **PASS**

In the configuration tested, the EUT complied with the standards specified above. The EUT technically complies with the RED Directive of 2014/53/EU requirements.

**Test/Witness Engineer** :



**Approved & Authorized** :

Handwritten signature 'Jack su' is overlaid on the stamp.



This report details the results of the testing carried out on one sample. The results contained in this test report do not relate to other samples of the same product. The manufacturer should ensure that all products in series production are in conformity with the product sample detailed in the report

## TABLE OF CONTENTS

<b>1. General Information.....</b>	<b>4</b>
1.1 Client Information.....	4
1.2.1 General Description of EUT (Equipment Under Test).....	4
1.3 Block Diagram Showing the Configuration of System Tested.....	5
1.4 Description of Support Units.....	5
1.5 Description of Operating Mode.....	6
1.6 Performance Criterion.....	6
1.7 Requirement of Performance Criteria.....	7
1.8 Test Facility.....	8
<b>2 Test Results Summary.....</b>	<b>9</b>
<b>3 Test Equipment Used.....</b>	<b>10</b>
<b>3 Conducted Disturbance Test.....</b>	<b>12</b>
3.1 Test Standard and Limit.....	12
3.2 Test Setup.....	12
3.3 Test Procedure.....	12
3.4 Test Condition.....	13
3.5 Test Data.....	13
<b>4 Radiated Disturbance Test.....</b>	<b>18</b>
4.1 Test Standard and Limit.....	18
4.2 Test Setup.....	19
4.3 Test Procedure.....	19
4.4 Test Condition.....	19
4.5 Test Data.....	19
<b>5 Harmonic Current Emission Test.....</b>	<b>25</b>
5.1 Test Standard and Limit.....	25
5.2 Test Setup.....	26
5.3 Test Procedure.....	26
5.4 Test Condition.....	26
5.5 Test Data.....	26
<b>6 Voltage Fluctuation and Flicker test.....</b>	<b>30</b>
6.1 Test Standard and Limit.....	30
6.2 Test Setup.....	30
6.3 Test Procedure.....	30
6.4 Test Condition.....	31
6.5 Test Data.....	31
<b>7 Electrostatic Discharge Immunity Test.....</b>	<b>33</b>
7.1 Test Requirements.....	33
7.2 Test Setup.....	33
7.3 Test Procedure.....	33
7.4 Test Data.....	34
<b>8 Radiated Electromagnetic Field Immunity test.....</b>	<b>36</b>
8.1 Test Requirements.....	36
8.2 Test Setup.....	36
8.3 Test Procedure.....	36
8.4 Test Data.....	37
<b>9 Electrical Fast Transient/Burst Test.....</b>	<b>39</b>

---

9.1 Test Requirements.....	39
9.2 Test Setup.....	39
9.3 Test Procedure.....	39
9.4 Test Data.....	40
<b>10 Surge Immunity Test.....</b>	<b>42</b>
10.1 Test Requirements.....	42
10.2 Test Setup.....	43
10.3 Test Procedure.....	43
10.4 Test Data.....	43
<b>11 Injection Current Test.....</b>	<b>45</b>
11.1 Test Requirements.....	45
11.2 Test Setup.....	45
11.3 Test Procedure.....	45
11.4 Test Data.....	46
<b>12 Voltage Dips and Interruptions Immunity Test.....</b>	<b>48</b>
12.1 Test Requirements.....	48
12.2 Test Setup.....	48
12.3 Test Procedure.....	48
12.4 Test Data.....	49
<b>13 Photographs - Constructional Details.....</b>	<b>50</b>

# 1. General Information

## 1.1 Client Information

<b>Applicant</b>	:	MyOnlineStores (Pty) Ltd.
<b>Address</b>	:	N4 Gateway Industrial Park, Unit 3, 21 Sneeuwberg Str, Willow Park Manor Ext65, Pretoria, 0184 South Africa
<b>Manufacturer</b>	:	MyOnlineStores (Pty) Ltd.
<b>Address</b>	:	N4 Gateway Industrial Park, Unit 3, 21 Sneeuwberg Str, Willow Park Manor Ext65, Pretoria, 0184 South Africa

### 1.2.1 General Description of EUT (Equipment Under Test)

<b>EUT Name</b>	:	Wifi Repeater	
<b>Model No.</b>	:	WR	
<b>Serial No.</b>	:	WR series wifi repeaters	
<b>Model Difference</b>	:	The different models are identical in schematic and critical component, the only different is the appearance.	
<b>Product Description</b>	:	Operation Frequency:	2412MHz~2472MHz
		Modulation Type:	802.11b: CCK, QPSK, BPSK 802.11g: OFDM 802.11n: OFDM
		Bit Rate of Transmitter:	802.11b:11/5.5/2/1Mbps 802.11g:54/48/36/24/18/12/9/6 Mbps 802.11n: up to 150Mbps
		Number of Channel:	Please see <b>Note(2)</b>
		Antenna Designation:	Please see <b>Note(3)</b>
		EIRP Power:	802.11b:12.86 dBm 802.11g: 12.35dBm 802.11n: 11.82 dBm
<b>Power Rating</b>	:	DC 5V, 1A	
<b>Connecting I/O Port(S)</b>	:	Please refer to the User's Manual	

**Note:**

- (1) For a more detailed features description, please refer to the manufacturer's specifications or the User's Manual.
- (2) Channel List:

Channel List
--------------

Channel	Frequency (MHz)	Channel	Frequency (MHz)	Channel	Frequency (MHz)
<b>01</b>	<b>2412</b>	06	2437	11	2462
02	2417	<b>07</b>	<b>2442</b>	12	2467
03	2422	08	2447	<b>13</b>	<b>2472</b>

### Antenna description

Ant.	Brand	Model Name	Antenna Type	Gain (dBi)
1	N/A	N/A	Embedded Ant.	0

## 1.3 Block Diagram Showing the Configuration of System Tested

### Mode 1: Loading Data from PC

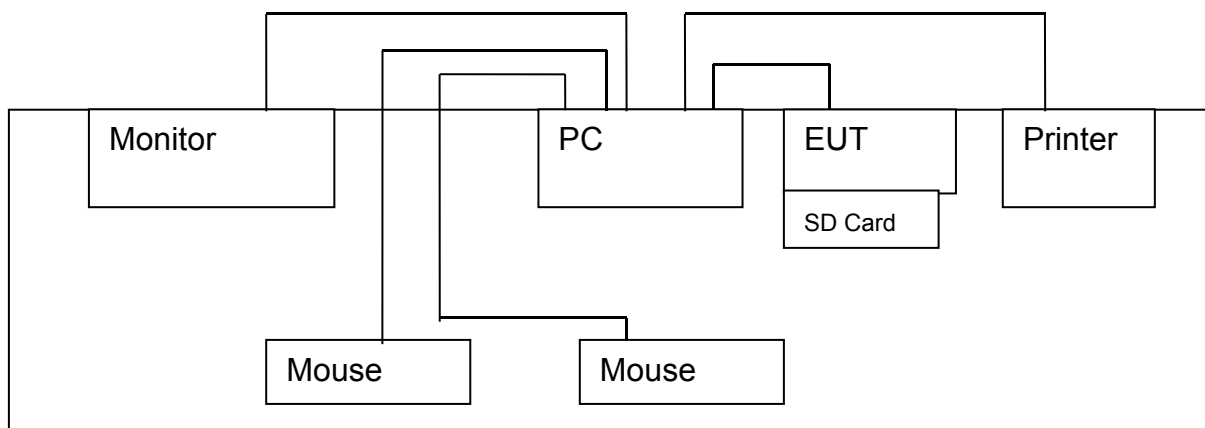

### Mode 2: WiFi Link

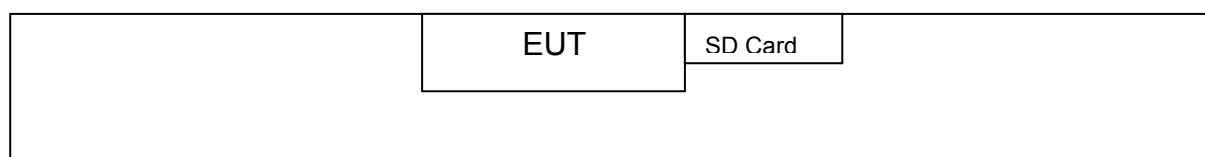

## 1.4 Description of Support Units

Name	Model	S/N	Manufacturer	Used "√"
SD Card	1 GB	----	Kingston	√
Flash Disk	1 GB	----	SSK	√
Headphone	H54E0	----	Sony	√
Printer	HP1505n	VNF3G06957	HP	√

Modem	RX304Xv2	----	ASUS	√
LCD Monitor	E170Sc	----	DELL	√
PC	OPTIPLEX380	----	DELL	√
TV	K102	----	KONKIA	√

## 1.5 Description of Operating Mode

To investigate the maximum EMI emission characteristics generated from EUT, the test system was pre-scanning tested based on the consideration of following EUT operation mode or test configuration mode which possible have effect on EMI emission level. Each of these EUT operation mode(s) or test configuration mode(s) mentioned above was evaluated respectively.

Pretest Mode	Description
Mode 1	Loading Data from PC
Mode 2	WiFi Link

The EUT system operated these modes were found to be the worst case during the pre-scanning test as Following:

EMI Test	
Final Test Mode	Description
Mode 1	Loading Data from PC
Mode 2	WiFi Link
Harmonics/Flicks Test	
Final Test Mode	Description
Mode 2	Loading Data from PC
EMS Test	
Final Test Mode	Description
Mode 1	Loading Data from PC
Mode 2	WiFi Link

## 1.6 Performance Criterion

According to **ETSI EN 301 489-17** standard, the general performance criteria as following:

Criterion	During Test	After test
-----------	-------------	------------

A	Shall operate as intended May show degradation of performance (see note 1) Shall be no loss of function Shall be no unintentional transmissions	Shall operate as intended Shall be no degradation of performance (see note 2) Shall be no loss of function Shall be no loss of stored data or user programmable functions
B	May show loss of function (one or more) May show degradation of performance (see note 1) No unintentional transmissions	Functions shall be self-recoverable shall operate as intended after recovering Shall be no degradation of performance (see note 2) Shall be no loss of stored data or user programmable functions
C	May be loss of function (one or more)	Functions shall be recoverable by the operator shall operate as intended after recovering Shall be no degradation of performance (see note 2)

NOTE 1: Degradation of performance during the test is understood as a degradation to a level not below a minimum performance level specified by the manufacturer for the use of the apparatus as intended. In some cases the specified minimum performance level may be replaced by a permissible degradation of performance. If the minimum performance level or the permissible performance degradation is not specified by the manufacturer then either of these may be derived from the product description and documentation (including leaflets and advertising) and what the user may reasonably expect from the apparatus if used as intended.

NOTE 2: No degradation of performance after the test is understood as no degradation below a minimum performance level specified by the manufacturer for the use of the apparatus as intended. In some cases the specified minimum performance level may be replaced by a permissible degradation of performance. After the test no change of actual operating data or user rLHievable data is allowed. If the minimum performance level or the permissible performance degradation is not specified by the manufacturer then either of these may be derived from the product description and documentation (including leaflets and advertising) and what the user may reasonably expect from the apparatus if used as intended.

## 1.7 Requirement of Performance Criteria

1	Performance criteria for continuous phenomena applied to transmitters (CT)	Criterion A of the applicable class shall apply
2	Performance criteria for transient phenomena applied to transmitters (TT)	Criterion B of the applicable class shall apply

---

---

3	Performance criteria for continuous phenomena applied to receivers (CR)	Criterion A of the applicable class shall apply
4	Performance criteria for transient phenomena applied to transmitters (TR)	Criterion B of the applicable class shall apply

## 1.8 Test Facility

The testing report were performed by the Shenzhen LH Testing Technology Co., Ltd., in their facilities located at 201 ~ 203, building 22, Yongli Industrial Zone, Tangxi, guxing community, Xixiang street, .



## 2 Test Results Summary

Test procedures according to the technical standards:

EMC Emission				
Standard	Test Item	Limit	Judgment	Remark
EN 55032: 2015/A1: 2020	Conducted Emission	Class B	PASS	
	Radiated Emission	Class B	PASS	
EN 55032: 2015/A1: 2020	Harmonic Current Emission	Class D NOTE(2)	PASS	
EN IEC 61000-3-2: 2019/A1: 2021	Voltage Fluctuations & Flicker		PASS	
EMC Immunity				
Standard	Test Item	Performance Criteria	Judgment	Remark
EN 61000-3-3:2013/A1:2019	Electrostatic Discharge	B	PASS	
EN 61000-4-2: 2009	RF electromagnetic field	A	PASS	
EN IEC 61000-4-3:2020	Fast transients	B	PASS	
EN 61000-4-4: 2012	Surges	B	PASS	
EN 61000-4-5: 2014/A1:2017	Injected Current	A	PASS	
EN 61000-4-6: 2014	Volt. Interruptions Dips	B / C / C NOTE (3)	PASS	

NOTE:

- (1) "N/A" denotes test is not applicable in this Test Report
- (2) The power consumption of EUT is less than 75W and no Limits apply.
- (3) Voltage dip: 100% reduction – Performance Criteria B  
 Voltage dip: 100% reduction – Performance Criteria B  
 Voltage dip: 70% reduction – Performance Criteria C  
 Voltage Interruption: 0% Interruption – Performance Criteria C

### 3 Test Equipment Used

<b>3.1 Test Equipment Used to Measure Conducted Disturbance</b>					
<b>No.</b>	<b>Equipment</b>	<b>Manufacturer</b>	<b>Model No.</b>	<b>Last Cal.</b>	<b>Cal. Interval</b>
LH-EMC001	EMI Test Receiver	Rohde & Schwarz	ESCS30	Dec.30, 2021	1 Year
LH-EMC002	AMN	Rohde & Schwarz	ESH3-Z5	Dec.30, 2021	1 Year
LH-EMC003	ANN	SCHWARZBECK	NNBL8226-2	Dec.30, 2021	1 Year
<b>3.2 Test Equipment Used to Measure Disturbance Power</b>					
<b>No.</b>	<b>Equipment</b>	<b>Manufacturer</b>	<b>Model No.</b>	<b>Last Cal.</b>	<b>Cal. Interval</b>
LH-EMC004	EMI Test Receiver	Rohde & Schwarz	ESI26	Dec.30, 2021	1 Year
LH-EMC005	Bilog Antenna	Chase	CBL6112B	Dec.30, 2021	1 Year
LH-EMC006	Positioning Controller	C&C	CC-C-1F	Dec.30, 2021	1 Year
<b>3.3 Test Equipment Used to Measure Harmonic Current/ Voltage Fluctuation and Flicker</b>					
<b>No.</b>	<b>Equipment</b>	<b>Manufacturer</b>	<b>Model No.</b>	<b>Last Cal.</b>	<b>Cal. Interval</b>
LH-EMC007	Harmonic Flicker Test System	CI	5001ix-CTS-40	Dec.30, 2021	1 Year
<b>3.4 Test Equipment Used to Measure Electrostatic Discharge Immunity</b>					
<b>No.</b>	<b>Equipment</b>	<b>Manufacturer</b>	<b>Model No.</b>	<b>Last Cal.</b>	<b>Cal. Interval</b>
LH-EMC008	ESD Tester	SCHNAFFNER	NSG435	Dec.30, 2021	1 Year
<b>3.5 Test Equipment Used to Measure Conducted Immunity</b>					
<b>No.</b>	<b>Equipment</b>	<b>Manufacturer</b>	<b>Model No.</b>	<b>Last Cal.</b>	<b>Cal. Interval</b>
LH-EMC009	RF Generator	FRANKONIA	CIT-10/75	Dec.30, 2021	1 Year
LH-EMC010	Attenuator	FRANKONIA	59-6-33	Dec.30, 2021	1 Year
LH-EMC011	M-CDN	LUTHI	M2/M3	Dec.30, 2021	1 Year
LH-EMC012	CDN	LUTHI	AF2	Dec.30, 2021	1 Year
LH-EMC013	EM Injection Clamp	LUTHI	EM101	Dec.30, 2021	1 Year
<b>3.6 Test Equipment Used to Measure Electrical Fast Transient/Burst Immunity</b>					
<b>No.</b>	<b>Equipment</b>	<b>Manufacturer</b>	<b>Model No.</b>	<b>Last Cal.</b>	<b>Cal. Interval</b>
LH-EMC014	Signal Generator	Rohde & Schwarz	SMT03	Dec.30, 2021	1 Year
LH-EMC015	Power Meter	Rohde & Schwarz	NRVD	Dec.30, 2021	1 Year

LH-EMC016	Voltage Probe	Rohde & Schwarz	URV5-Z2	Dec.30, 2021	1 Year
LH-EMC017	Voltage Probe	Rohde & Schwarz	URV5-Z2	Dec.30, 2021	1 Year
LH-EMC018	Power Amplifier	AR	150W1000	Dec.30, 2021	1 Year
LH-EMC019	Bilog Antenna	Chase	CBL6111C	Dec.30, 2021	1 Year

### 3.7 Test Equipment Used to Measure Electrical Fast Transient/Burst Immunity

No.	Equipment	Manufacturer	Model No.	Last Cal.	Cal. Interval
LH-EMC020	Simulator	EMTEST	UCWRM4	Dec.30, 2021	1 Year
LH-EMC021	Auto-transformer	EMTEST	V4780S2	Dec.30, 2021	1 Year

### 3.8 Test Equipment Used to Measure Surge Immunity

No.	Equipment	Manufacturer	Model No.	Last Cal.	Cal. Interval
LH-EMC022	Simulator	EMTEST	UCWRM4	Dec.30, 2021	1 Year
LH-EMC023	Coupling Clamp	EMTEST	HFK	Dec.30, 2021	1 Year

### 3.9 Test Equipment Used to Measure Voltage Dips and Interruptions Immunity

No.	Equipment	Manufacturer	Model No.	Last Cal.	Cal. Interval
LH-EMC024	Simulator	EMTEST	UCWRN5	Dec.30, 2021	1 Year
LH-EMC025	Auto-transformer	EMTEST	V4780S2	Dec.30, 2021	1 Year

### 3.10 Test Equipment Used to Measure Power Frequency magnetic field

No.	Equipment	Manufacturer	Model No.	Last Cal.	Cal. Interval
LH-EMC026	Power Frequency Magnetic Field Generator	EMTEST	----	Dec.30, 2021	1 Year

## 3 Conducted Disturbance Test

### 3.1 Test Standard and Limit

#### 3.1.1 Test Standard

ETSI EN 301 489-1 Clause 8.4

ETSI EN 301 489-17

#### 3.1.2 Test Limit

**Conducted Disturbance Test Limit**

Frequency	Maximum RF Line Voltage (Db $\mu$ V)	
	Quasi-peak Level	Average Level
150kHz~500kHz	66 ~ 56 *	56 ~ 46 *
500kHz~5MHz	56	46
5MHz~30MHz	60	50

Remark: \*Decreasing linearly with logarithm of the frequency

### 3.2 Test Setup

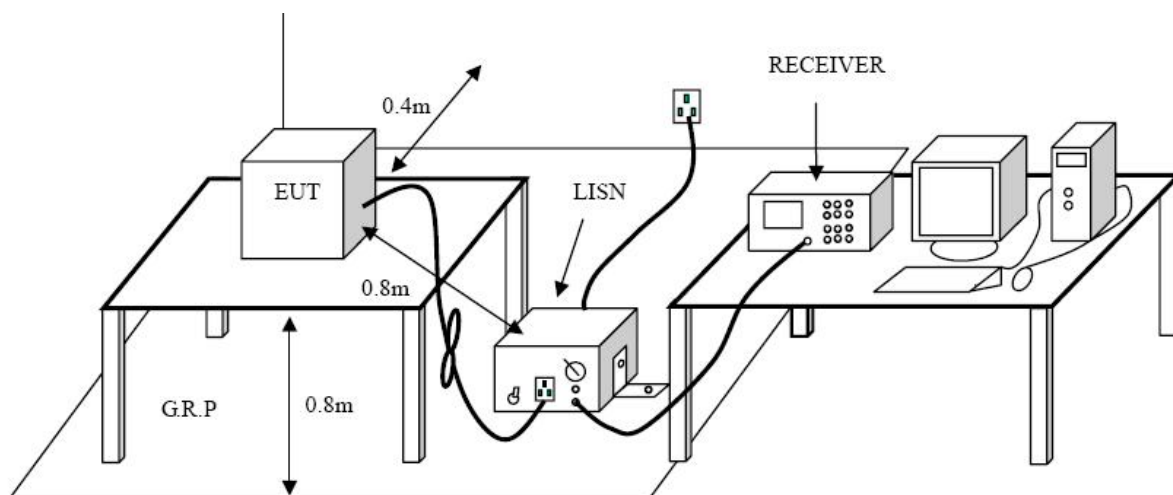

### 3.3 Test Procedure

The EUT was placed 0.8 meters from the horizontal ground plane with EUT being connected to the power mains through a line impedance stabilization network (LISN). All other support equipments powered from additional LISN(s). The LISN provide 50 Ohm/ 50uH of coupling impedance for the measuring instrument.

Interconnecting cables that hang closer than 40 cm to the ground plane shall be folded back and forth in the center forming a bundle 30 to 40 cm long.

I/O cables that are not connected to a peripheral shall be bundled in the center. The end of the cable may be terminated, if required, using the correct terminating impedance. The overall length shall not exceed 1 m. LISN at least 80 cm from the nearest part of EUT chassis. The bandwidth of EMI test receiver is set at 9kHz, and the test frequency band is from 0.15MHz to 30MHz.

### 3.4 Test Condition

Temperature	:	25 °C
Relative Humidity	:	48 %
Pressure	:	1010 hPa
Test Power	:	DC 5V

### 3.5 Test Data

Please refer the following pages.

**Operating Condition: Mode 1**

**Test Specification: Line**

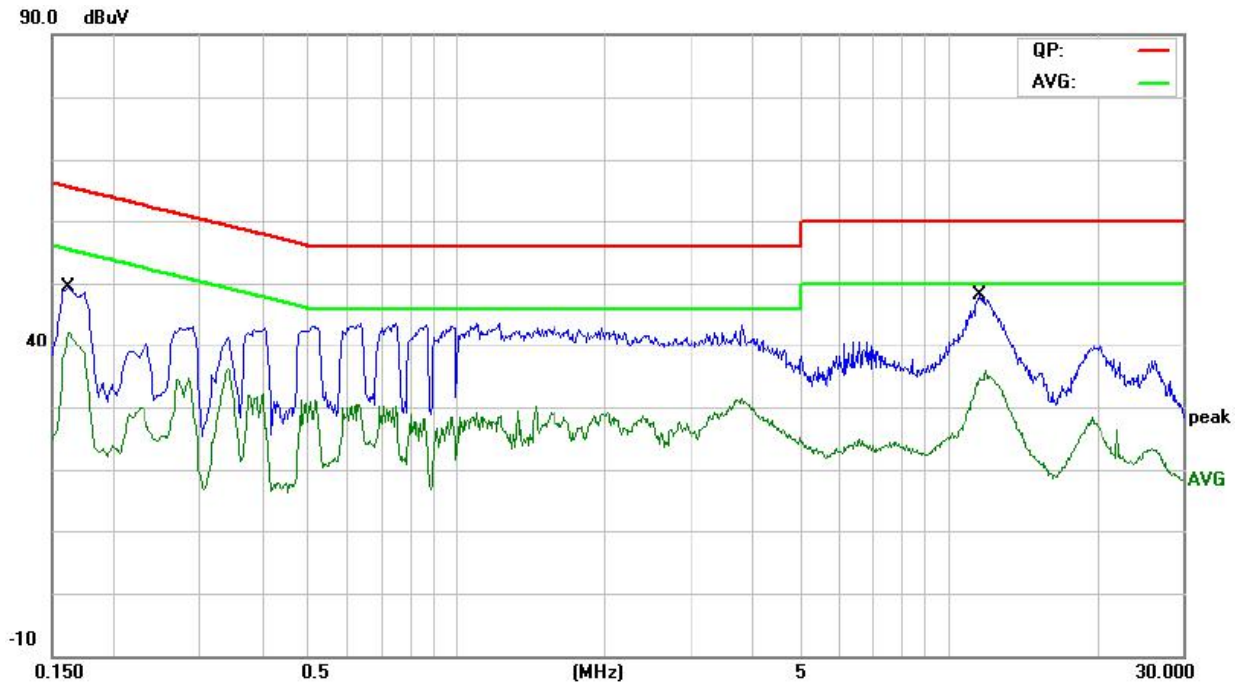

No.	Mk.	Freq.	Reading Level	Correct Factor	Measurement	Limit	Over	Detector	Comment
		MHz	dBuV	dB	dBuV	dBuV	dB		
1		0.1620	37.15	10.76	47.91	65.36	-17.45	QP	
2	*	0.1620	30.82	10.76	41.58	55.36	-13.78	AVG	
3		11.6500	33.05	9.94	42.99	60.00	-17.01	QP	
4		11.6500	24.46	9.94	34.40	50.00	-15.60	AVG	

**Operating Condition: Mode 1**

**Test Specification: Neutral**

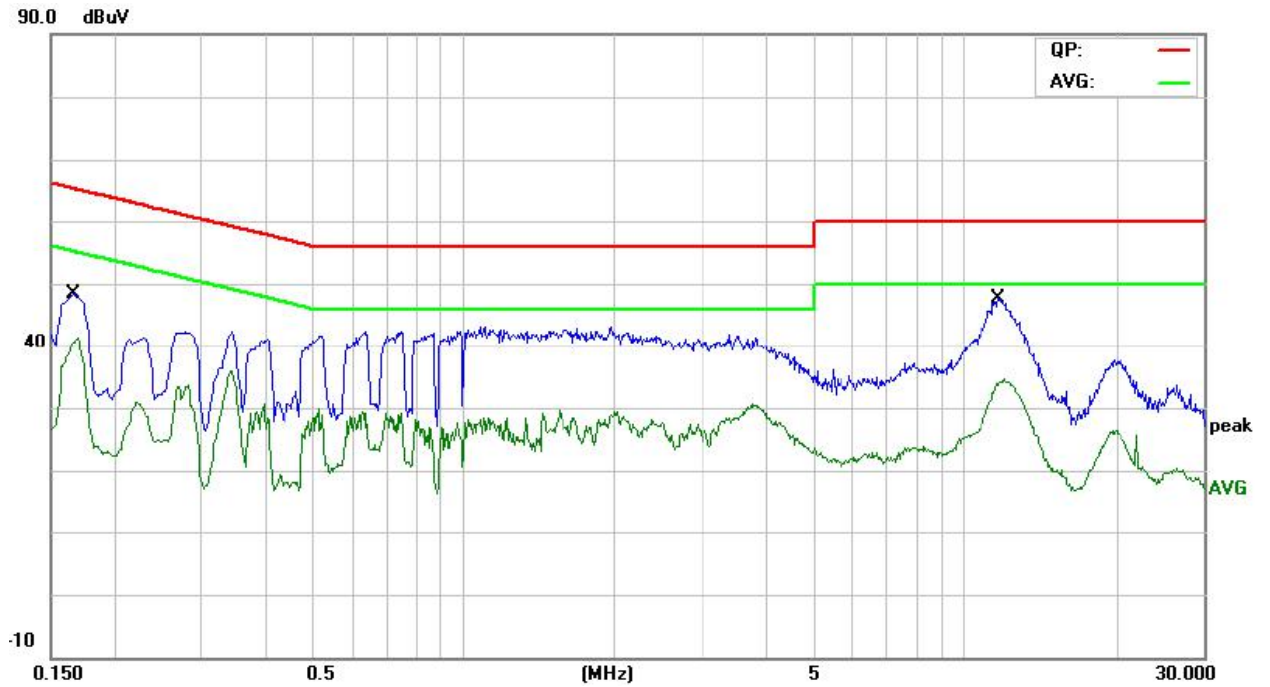

No.	Mk.	Freq.	Reading Level	Correct Factor	Measurement	Limit	Over	Detector	Comment
		MHz	dBuV	dB	dBuV	dBuV	dB		
1		0.1660	36.48	10.74	47.22	65.15	-17.93	QP	
2	*	0.1660	30.42	10.74	41.16	55.15	-13.99	AVG	
3		11.6860	32.00	9.97	41.97	60.00	-18.03	QP	
4		11.6860	22.50	9.97	32.47	50.00	-17.53	AVG	

**Operating Condition: Mode 2**  
**Test Specification: Line**

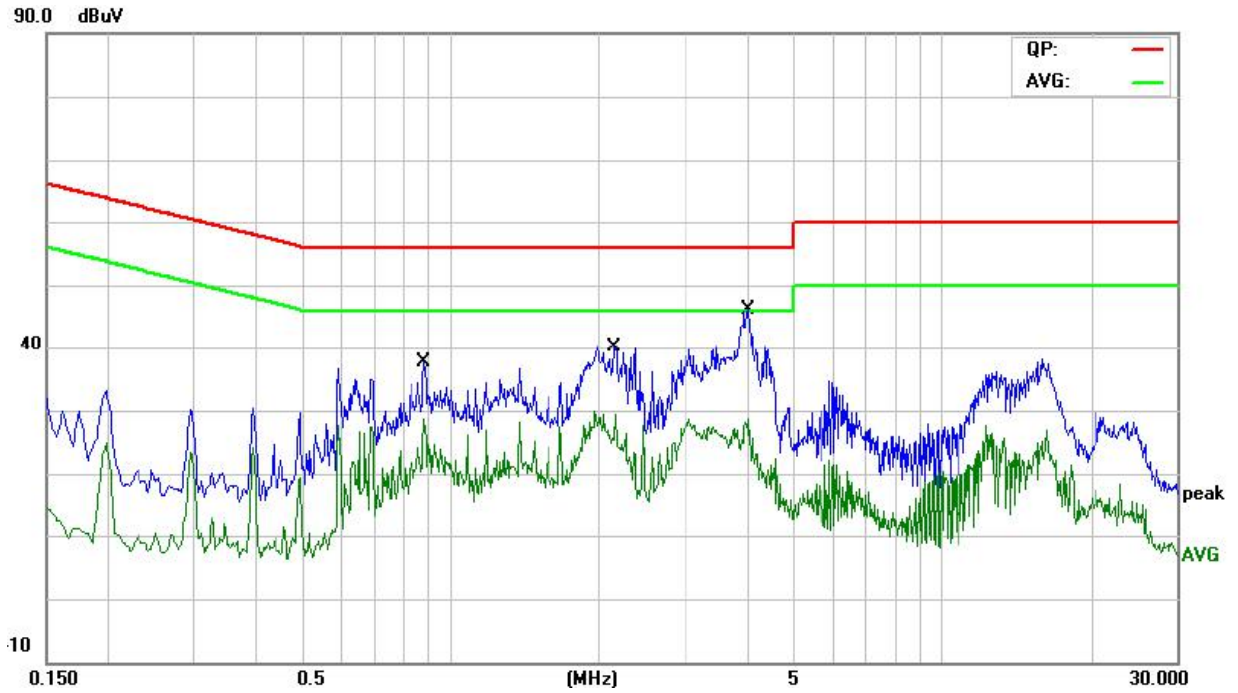

No.	Mk.	Freq. MHz	Reading Level dBuV	Correct Factor dB	Measure- ment dBuV	Limit dBuV	Over dB	Detector	Comment
1		0.8820	23.81	9.39	33.20	56.00	-22.80	QP	
2	*	0.8820	18.25	9.39	27.64	46.00	-18.36	AVG	
3		2.1460	21.38	9.34	30.72	56.00	-25.28	QP	
4		2.1460	15.16	9.34	24.50	46.00	-21.50	AVG	
5		4.0220	21.70	9.41	31.11	56.00	-24.89	QP	
6		4.0220	10.59	9.41	20.00	46.00	-26.00	AVG	



**Operating Condition: Mode 2**  
**Test Specification: Neutral**

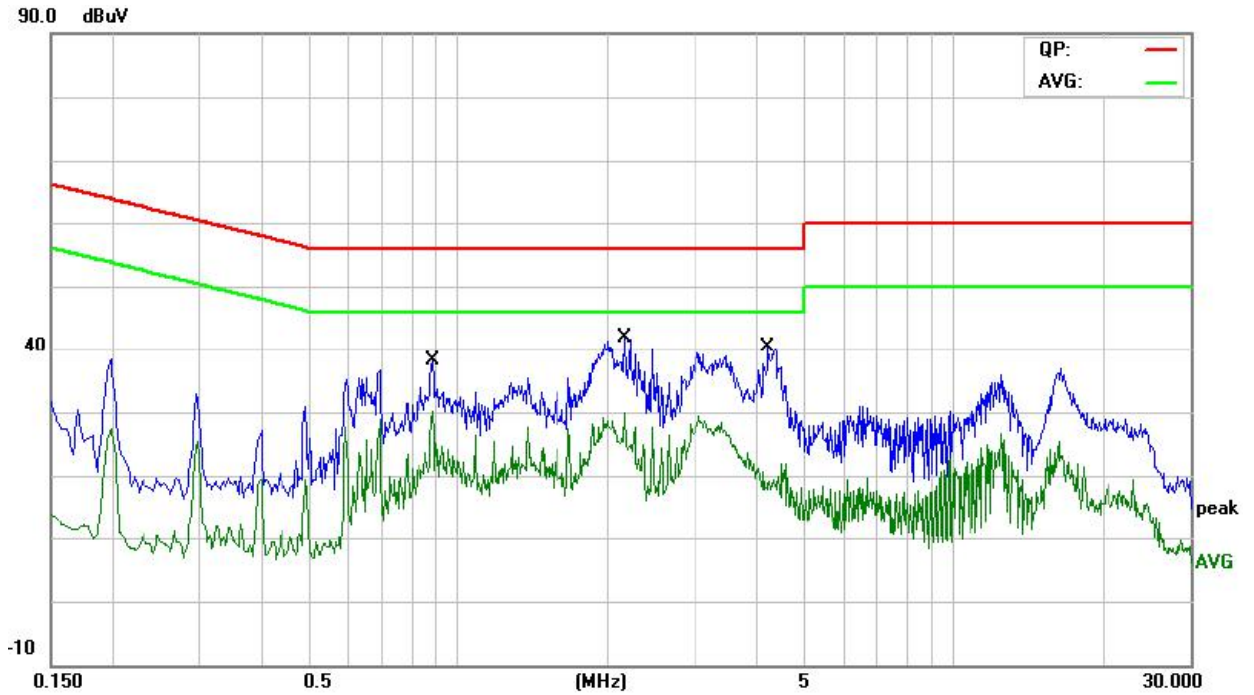

No.	Mk.	Freq. MHz	Reading Level dBuV	Correct Factor dB	Measure- ment dBuV	Limit dBuV	Over dB	Detector	Comment
1		0.8860	25.35	9.41	34.76	56.00	-21.24	QP	
2		0.8860	19.40	9.41	28.81	46.00	-17.19	AVG	
3		2.1619	26.29	9.37	35.66	56.00	-20.34	QP	
4	*	2.1619	19.89	9.37	29.26	46.00	-16.74	AVG	
5		4.2220	21.33	9.45	30.78	56.00	-25.22	QP	
6		4.2220	8.28	9.45	17.73	46.00	-28.27	AVG	

## 4 Radiated Disturbance Test

### 4.1 Test Standard and Limit

#### 4.1.1 Test Standard

ETSI EN 301 489-1 Clause 8.2

ETSI EN 301 489-17

#### 4.1.2 Test Limit

##### Radiated Disturbance Test Limit

FREQUENCY (MHz)	Class A (at 10m)	Class B (at 10m)
	dBuV/m	dBuV/m
30 – 230	40	30
230 – 1000	47	37

Notes:

- (1) The limit for radiated test was performed according to as following: EN 55022
- (2) The tighter limit applies at the band edges.
- (3) Emission level (dBuV/m)=20log Emission level (uV/m).

##### Limits Of Radiated Emission Measurement (Above 1000MHz)

FREQUENCY (MHz)	Class A (dBuV/m) (at 3m)		Class B (dBuV/m) (at 3m)	
	PEAK	AVERAGE	PEAK	AVERAGE
1000-3000	76	56	70	50
3000-6000	80	60	74	54

Notes:

- (1) The lower limit applies at the transition frequency.

##### Frequency Range of Radiated Measurement

Highest frequency generated or Upper frequency of measurement used in the device or on which the device operates or tunes (MHz)	Range (MHz)
Below 108	1000
108 – 500	2000
500 – 1000	5000
Above 1000	5th harmonic of the highest frequency or 6 GHz, whichever is lower

## 4.2 Test Setup

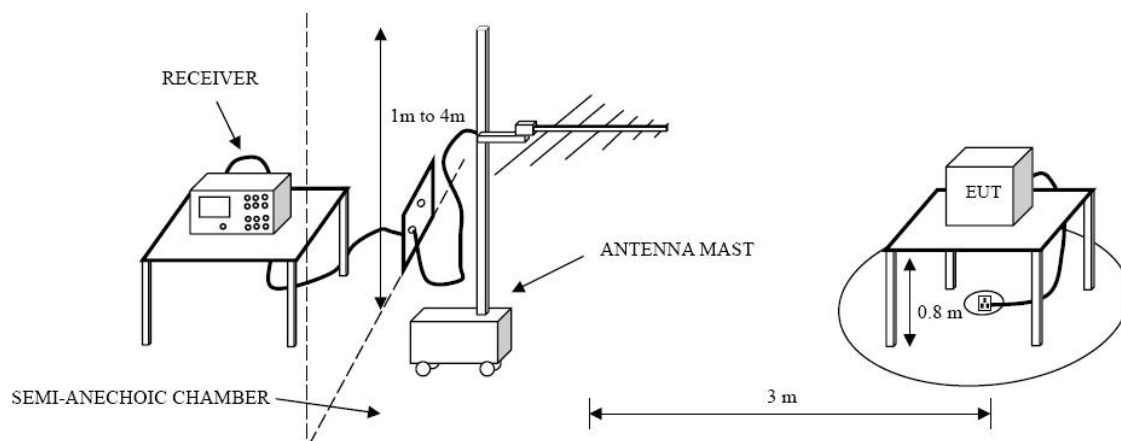

## 4.3 Test Procedure

The EUT was placed on the top of a rotating table 0.8 meters above the ground at a 3m. The table was rotated 360 degrees to determine the position of the highest radiation.

The height of the equipment or of the substitution antenna shall be 0.8 m; the height of the test antenna shall vary between 1 m to 4 m. Both horizontal and vertical polarizations of the antenna are set to make the measurement.

The initial step in collecting radiated emission data is a spectrum Quasi Peak detector mode scanning the measurement frequency range.

If the Peak Mode measured value compliance with and lower than Quasi Peak Mode Limit, the EUT shall be deemed to meet QP Limits and then no additional QP Mode measurement performed.

## 4.4 Test Condition

Temperature	:	25 °C
Relative Humidity	:	48 %
Pressure	:	1010 hPa
Test Power	:	DC 5V

## 4.5 Test Data

Please refer to the following pages.

(1) Bellow 1 G

Operation Condition: Mode 1

Test Specification: Horizontal

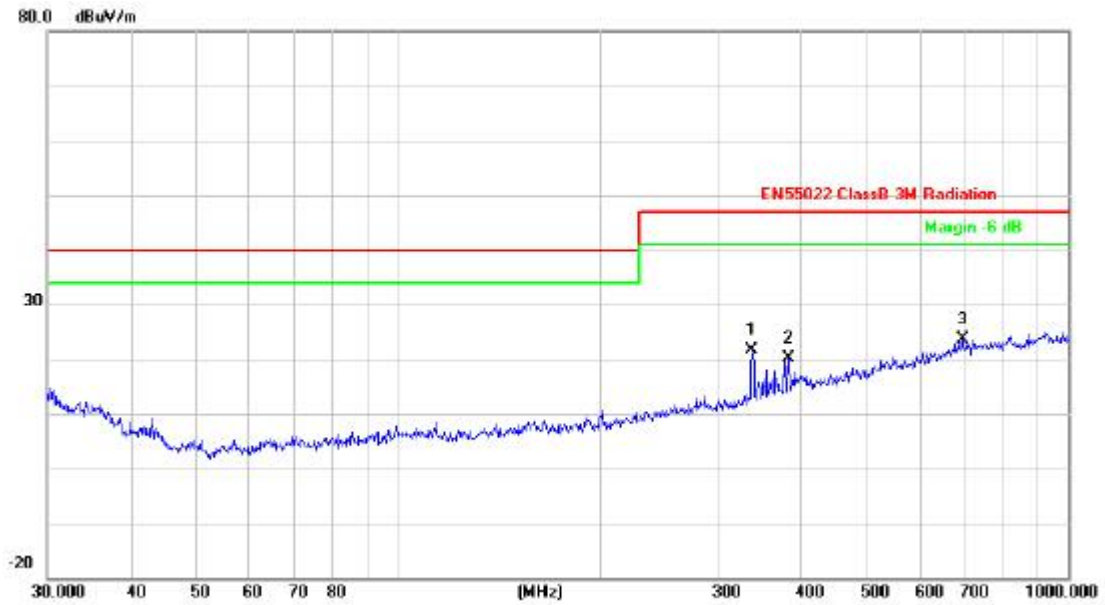

No.	Mk.	Freq. MHz	Reading Level dBuV	Correct Factor dB/m	Measure- ment dBuV/m	Limit dBuV/m	Over dB	Detector
1		337.2155	37.00	-15.39	21.61	47.00	-25.39	peak
2		382.5879	34.03	-13.96	20.07	47.00	-26.93	peak
3	*	694.4174	30.65	-7.01	23.64	47.00	-23.36	peak

**Operation Condition: Mode 1**  
**Test Specification: Vertical**

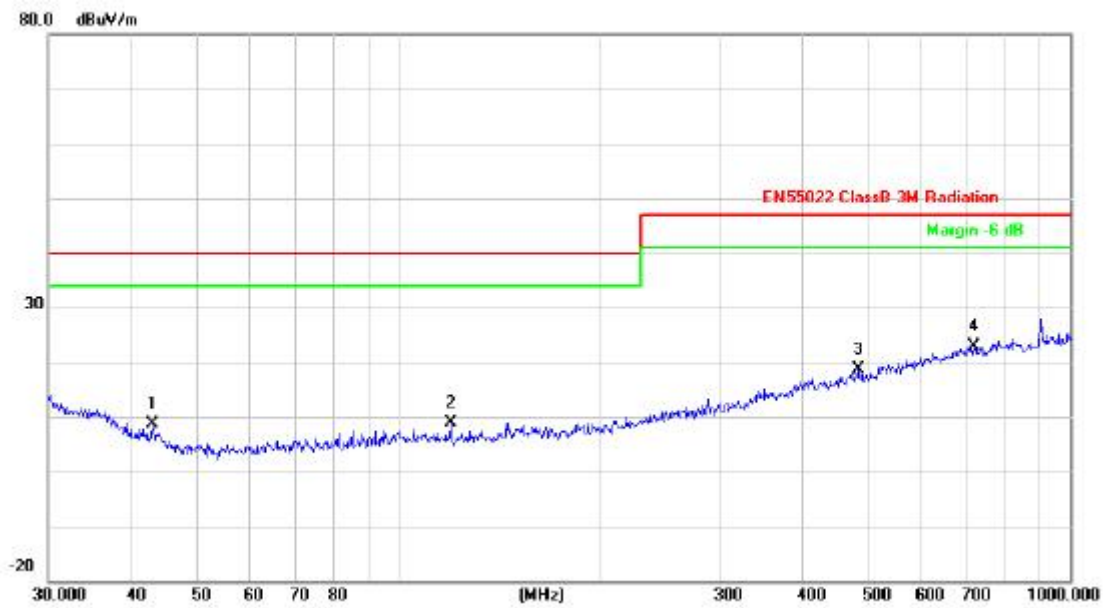

No.	Mk.	Freq. MHz	Reading Level dBuV	Correct Factor dB/m	Measure- ment dBuV/m	Limit dBuV/m	Over dB	Detector
1		42.8998	29.97	-21.39	8.58	40.00	-31.42	peak
2		119.4361	31.42	-22.47	8.95	40.00	-31.05	peak
3		482.2156	30.26	-11.63	18.63	47.00	-28.37	peak
4	*	719.1995	29.92	-7.08	22.84	47.00	-24.16	peak

**Operation Condition: Mode 2**  
**Test Specification: Horizontal**

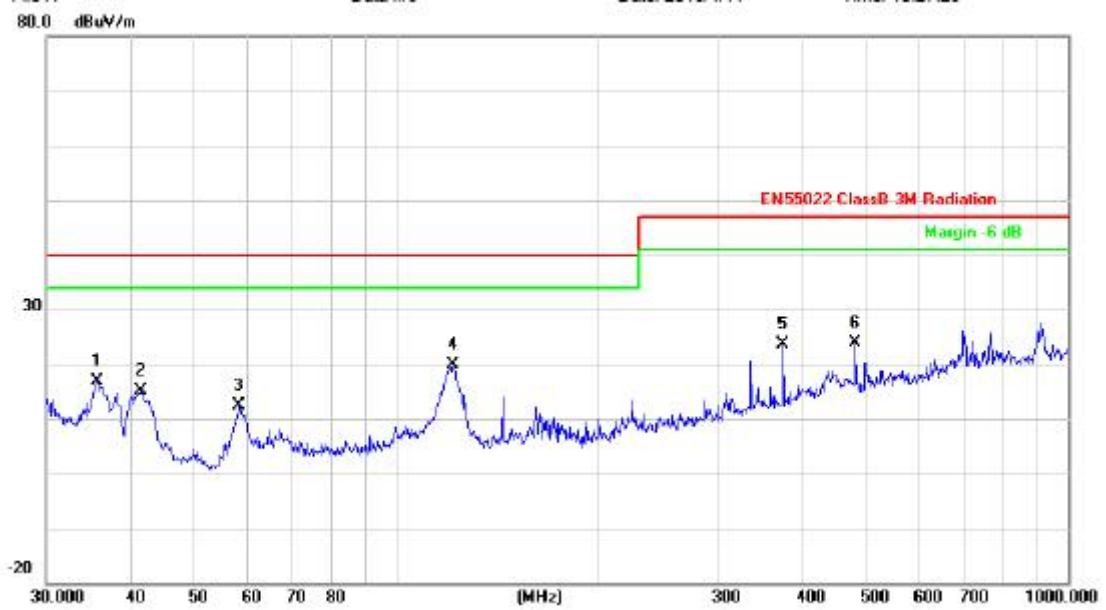

No.	Mk.	Freq. MHz	Reading Level dBuV	Correct Factor dB/m	Measure- ment dBuV/m	Limit dBuV/m	Over dB	Detector
1		35.8746	44.97	-17.60	27.37	40.00	-12.63	peak
2		39.8542	42.92	-20.07	22.85	40.00	-17.15	peak
3		57.9993	49.43	-24.50	24.93	40.00	-15.07	peak
4		67.9129	42.03	-23.80	18.23	40.00	-21.77	peak
5	*	121.1231	52.89	-22.47	30.42	40.00	-9.58	peak
6		480.5276	43.78	-11.62	32.16	47.00	-14.84	peak



**Operation Condition: Mode 2**  
**Test Specification: Vertical**

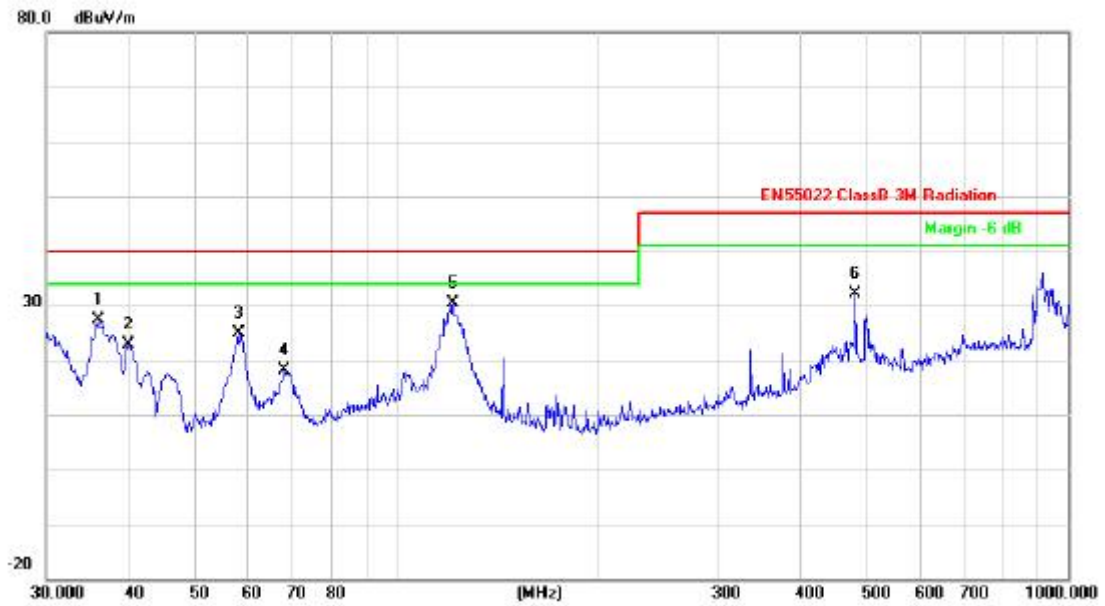

No.	Mk.	Freq. MHz	Reading Level dBuV	Correct Factor dB/m	Measure- ment dBuV/m	Limit dBuV/m	Over dB	Detector
1	*	47.9940	73.22	-23.54	49.68	40.00	9.68	peak
2	X	59.8588	69.53	-24.53	45.00	40.00	5.00	peak
3	!	72.0843	62.33	-23.54	38.79	40.00	-1.21	peak
4	!	83.8156	62.21	-23.06	39.15	40.00	-0.85	peak
5	X	119.8556	71.67	-22.50	49.17	40.00	9.17	peak
6	!	216.7828	58.94	-19.67	39.27	40.00	-0.73	peak

**(2) Above 1 G**

<b>EUT:</b>	Wifi Repeater	<b>Model Name :</b>	WR
<b>Temperature:</b>	26°C	<b>Relative Humidity:</b>	60%
<b>Pressure:</b>	1010 hPa	<b>Test Voltage :</b>	DC 5V
<b>Antenna :</b>	Vertical		
<b>Test Mode :</b>	Mode 2		

No.	Frequency	Measurment	Limit	Margin	Detector	Note
	(MHz)	(dBuv/m)	(dBuv/m)	( dB)		
1	1221.000	36.62	70	30.55	peak	
2	1221.000	31.53	50	16.72	AVG	

<b>EUT:</b>	Wifi Repeater	<b>Model Name :</b>	WR
<b>Temperature:</b>	26°C	<b>Relative Humidity:</b>	60%
<b>Pressure:</b>	1010 hPa	<b>Test Voltage :</b>	DC 5V
<b>Antenna :</b>	Horizontal		
<b>Test Mode :</b>	Mode 2		

No.	Frequency	Measurment	Limit	Margin	Detector	Note
	(MHz)	(dBuv/m)	(dBuv/m)	( dB)		
1	1223.000	35.36	70	33.75	peak	
2	1223.000	30.52	50	20.32	AVG	



## 5 Harmonic Current Emission Test

### 5.1 Test Standard and Limit

#### 5.1.1 Test Standard

ETSI EN 301 489-1 Clause 8.5

ETSI EN 301 489-17

EN 61000-3-2: 2014

#### 5.1.2 Limits

IEC 555-2					
Table- I			Table-II		
Equipment Category	Harmonic order n	Max. permissible harmonic current (in Amperes)	Equipment Category	Harmonic order n	Max. permissible harmonic current (in Amperes)
Non Portable Tools Or TV Receivers	odd harmonics		TV Receivers	odd harmonics	
	3	2.30		3	0.8
	5	1.14		5	0.65
	7	0.77		7	0.45
	9	0.40		9	0.30
	11	0.33		11	0.17
	13	0.21		13	0.12
	15 ≤ n ≤ 39	0.15 · 15/n		15 ≤ n ≤ 39	0.10 · 15/n
	even harmonics			even harmonics	
	2	1.08		2	0.30
	4	0.43		4	0.15
	8	0.30			
	8 ≤ n ≤ 40	0.23 · 8/n		DC	0.05
	EN 61000-3-2				
Equipment Category	Max. permissible harmonic current (in Amperes)	Equipment Category	Harmonic order n	Max. permissible harmonic current	
Class A	Same as Limits Specified in Table I But only odd Harmonics required	Class D		(in A)	(mA/w)
			3	2.30	3.4
			5	1.14	1.9
			7	0.77	1.0
			9	0.40	0.5
			11	0.33	0.35
8 ≤ n ≤ 40	See Tabel I	3.85/n			
Only odd harmonics required					

## 5.2 Test Setup

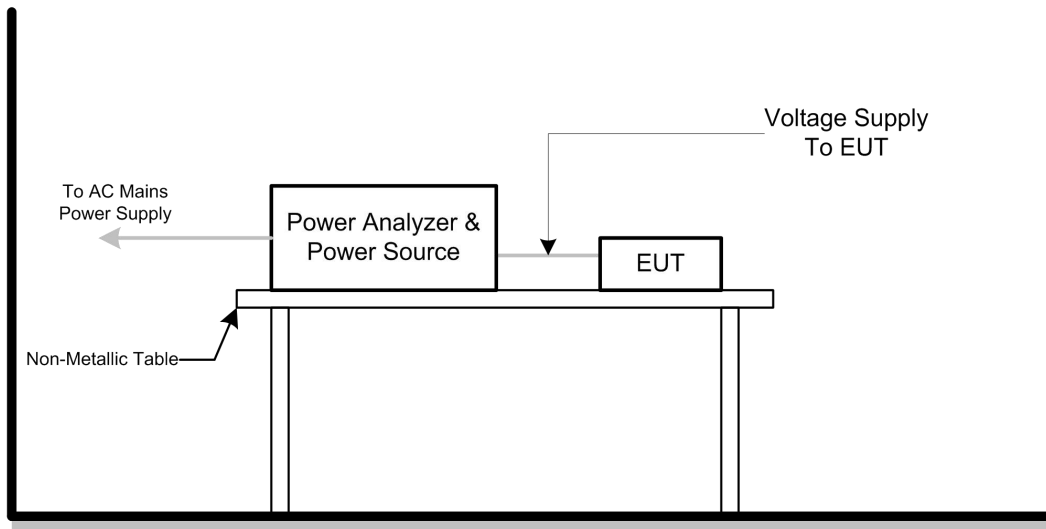

## 5.3 Test Procedure

The EUT was placed on the top of a wooden table 0.8 meters above the ground and operated to produce the maximum harmonic components under normal operating conditions.

The classification of EUT is according to section 5 of EN 61000-3-2. The EUT is classified as follows:

Class A: Balanced three-phase equipment, Household appliances excluding equipment as Class D, Tools excluding portable tools, Dimmers for incandescent lamps, audio equipment, equipment not specified in one of the three other classes.

Class B: Portable tools. Arc welding equipment which is not professional equipment.

Class C: Lighting equipment.

Class D: Equipment having a specified power less than or equal to 600 W of the following types:  
Personal computers and personal computer monitors and television receivers.

## 5.4 Test Condition

Temperature	:	25 °C
Relative Humidity	:	48 %
Pressure	:	1010 hPa
Test Power	:	DC 5V

## 5.5 Test Data

Please see the following pages.

### Harmonics – Class-D per Ed. 3.0 (2014)(Run time)

Test category: Class-D per Ed. 3.0 (2014) (European limits)

Test Margin: 100

Tested by: LH

Start time: 11:30:43

End time: 11:41:05

Test duration (min): 10

Data file name: H-000388.cts\_data

Test Result: N/L

Source qualification: Normal

#### Current & voltage waveforms

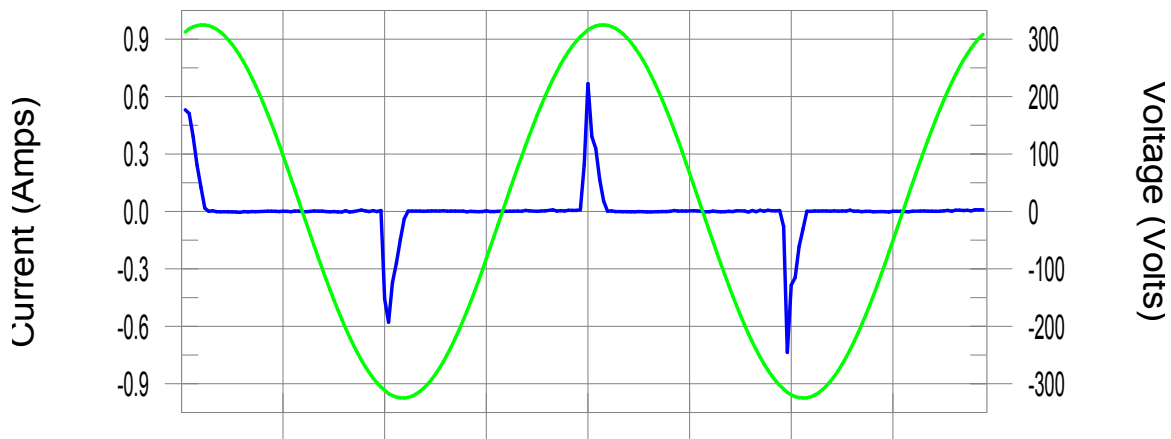

#### Harmonics and Class D limit line

#### European Limits

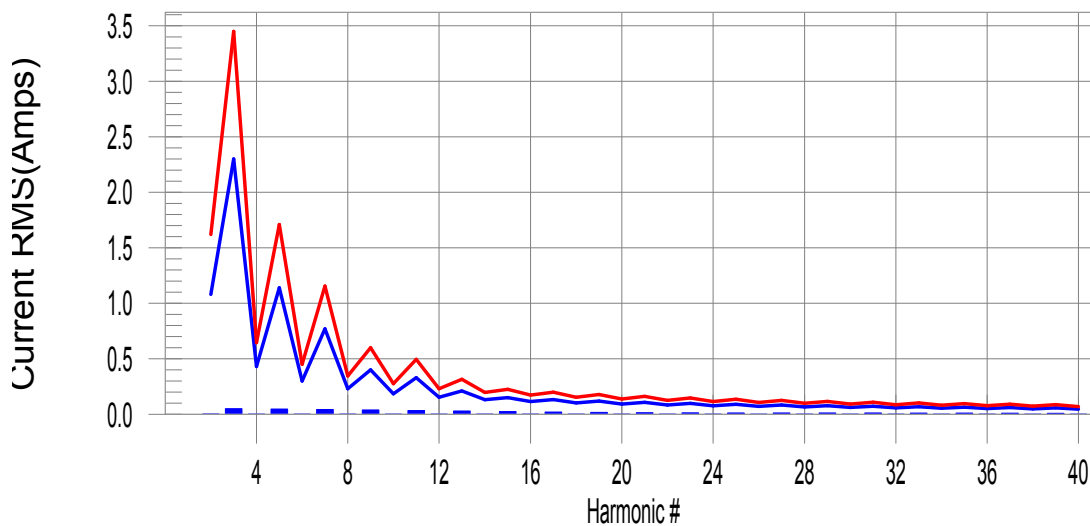

Test result: N/L Worst harmonic was #0 with 0.00% of the limit.

### Current Test Result Summary (Run time)

Test category: Class-D per Ed. 3.0 (2012) (European limits)  
 Test Margin: 100                      Tested by: LH  
 Start time: 11:30:43                End time: 11:41:05  
 Test duration (min): 10              Data file name: H-000388.cts\_data

Test Result: N/L                      Source qualification: Normal  
 THC(A): 0.00                      I-THD(%): 0.00                      POHC(A): 0.000                      POHC Limit(A): 0.000  
 Highest parameter values during test:  
     V\_RMS (Volts): 229.95                      Frequency(Hz): 50.00  
     I\_Peak (Amps): 0.836                      I\_RMS (Amps): 0.139  
     I\_Fund (Amps): 0.058                      Crest Factor: 6.071  
     Power (Watts): 13.1                      Power Factor: 0.417

Harm#	Harms(avg)	100%Limit	%of Limit	Harms(max)	150%Limit	%of Limit	Status
2	0.001	1.080	0.0	0.001	1.620	0.07	Pass
3	0.046	2.300	2.0	0.050	3.450	1.45	Pass
4	0.001	0.430	0.0	0.001	0.645	0.14	Pass
5	0.044	1.140	3.8	0.047	1.710	2.74	Pass
6	0.000	0.300	0.0	0.001	0.450	0.15	Pass
7	0.041	0.770	5.3	0.043	1.155	3.74	Pass
8	0.000	0.230	0.0	0.001	0.345	0.16	Pass
9	0.037	0.400	9.2	0.039	0.600	6.50	Pass
10	0.000	0.184	0.0	0.001	0.276	0.22	Pass
11	0.033	0.330	9.9	0.034	0.495	6.90	Pass
12	0.000	0.153	0.0	0.001	0.230	0.26	Pass
13	0.028	0.210	13.5	0.029	0.315	9.31	Pass
14	0.000	0.131	0.0	0.001	0.197	0.26	Pass
15	0.024	0.150	15.9	0.025	0.225	10.92	Pass
16	0.000	0.115	0.0	0.001	0.173	0.29	Pass
17	0.020	0.132	15.0	0.020	0.199	10.18	Pass
18	0.000	0.102	0.0	0.001	0.153	0.33	Pass
19	0.016	0.118	13.8	0.017	0.178	9.39	Pass
20	0.000	0.092	0.0	0.001	0.138	0.36	Pass
21	0.014	0.107	12.8	0.014	0.161	8.74	Pass
22	0.000	0.084	0.0	0.001	0.125	0.45	Pass
23	0.012	0.098	12.3	0.013	0.147	8.57	Pass
24	0.000	0.077	0.0	0.001	0.115	0.54	Pass
25	0.011	0.090	12.6	0.012	0.135	8.91	Pass
26	0.000	0.071	0.0	0.001	0.106	0.61	Pass
27	0.011	0.083	13.3	0.012	0.125	9.53	Pass
28	0.000	0.066	0.0	0.001	0.099	0.67	Pass
29	0.011	0.078	14.2	0.012	0.116	10.21	Pass
30	0.000	0.061	0.0	0.001	0.092	0.75	Pass
31	0.011	0.073	14.9	0.012	0.109	10.67	Pass
32	0.000	0.058	0.0	0.001	0.086	0.81	Pass
33	0.010	0.068	15.3	0.011	0.102	10.94	Pass
34	0.000	0.054	0.0	0.001	0.081	0.87	Pass
35	0.010	0.064	15.3	0.011	0.096	10.95	Pass
36	0.000	0.051	0.0	0.001	0.077	0.93	Pass
37	0.009	0.061	15.0	0.010	0.091	10.74	Pass
38	0.000	0.048	0.0	0.001	0.073	0.99	Pass
39	0.008	0.058	14.5	0.009	0.087	10.43	Pass
40	0.000	0.046	0.0	0.001	0.069	1.09	Pass
40	0.000						

Note: The EUT power level is below 75.0 Watts and therefore has no defined limits

### Voltage Source Verification Data (Run time)

Test category: Class-D per Ed. 3.0 (2012) (European limits)  
 Test Margin: 100                      Tested by: LH  
 Start time: 11:30:43                End time: 11:41:05  
 Test duration (min): 10              Data file name: H-000388.cts\_data

Test Result: N/L                      Source qualification: Normal

Highest parameter values during test:

Voltage (Vrms):	229.95	Frequency(Hz):	50.00
I_Peak (Amps):	0.836	I_RMS (Amps):	0.139
I_Fund (Amps):	0.058	Crest Factor:	6.071
Power (Watts):	13.1	Power Factor:	0.417

Harm#	Harmonics V-rms	Limit V-rms	% of Limit	Status
2	0.069	0.460	15.04	OK
3	0.527	2.069	25.45	OK
4	0.052	0.460	11.21	OK
5	0.051	0.920	5.54	OK
6	0.020	0.460	4.45	OK
7	0.032	0.690	4.60	OK
8	0.011	0.460	2.38	OK
9	0.046	0.460	10.01	OK
10	0.015	0.460	3.17	OK
11	0.026	0.230	11.28	OK
12	0.013	0.230	5.54	OK
13	0.025	0.230	10.81	OK
14	0.005	0.230	2.21	OK
15	0.020	0.230	8.56	OK
16	0.008	0.230	3.35	OK
17	0.021	0.230	9.11	OK
18	0.011	0.230	4.63	OK
19	0.018	0.230	7.79	OK
20	0.009	0.230	3.81	OK
21	0.016	0.230	7.07	OK
22	0.005	0.230	2.19	OK
23	0.014	0.230	6.27	OK
24	0.004	0.230	1.65	OK
25	0.017	0.230	7.52	OK
26	0.003	0.230	1.42	OK
27	0.016	0.230	7.01	OK
28	0.003	0.230	1.34	OK
29	0.017	0.230	7.46	OK
30	0.004	0.230	1.76	OK
31	0.018	0.230	7.83	OK
32	0.003	0.230	1.39	OK
33	0.017	0.230	7.57	OK
34	0.003	0.230	1.28	OK
35	0.017	0.230	7.47	OK
36	0.003	0.230	1.23	OK
37	0.018	0.230	7.92	OK
38	0.003	0.230	1.26	OK
39	0.016	0.230	7.11	OK
40	0.006	0.230	2.43	OK

## 6 Voltage Fluctuation and Flicker test

### 6.1 Test Standard and Limit

#### 6.1.1 Test Standard

ETSI EN 301 489-1 Clause 8.6  
ETSI EN 301 489-17  
EN 61000-3-3: 2013

#### 6.1.2 Limit

**Flicker Test Limit**

Tests	Limits		Descriptions
	IEC555-3	IEC 61000-3-3	
Pst	≤ 1.0, Tp= 10 min.	≤ 1.0, Tp= 10 min.	Short Term Flicker Indicator
Plt	N/A	≤ 0.65, Tp=2 hr.	Long Term Flicker Indicator
dc	≤ 3 %	≤ 3 %	Relative Steady-State V-Chang
dmax	≤ 4 %	≤ 4 %	Maximum Relative V-change
d (t)	N/A	≤ 3% for > 200 ms	RelativeV-change characteristic

### 6.2 Test Setup

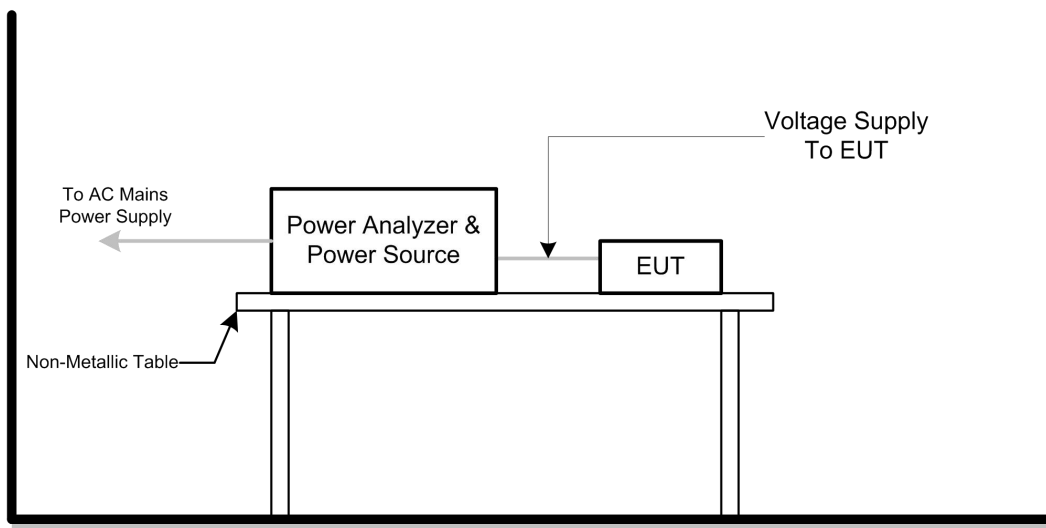

### 6.3 Test Procedure

#### 6.3.1 Fluctuation and Flickers Test:

Tests was performed according to the Test Conditions/Assessment of Voltage Fluctuations specified in Clause 5.0/6.0 of IEC555-3 and/or Clause 6.0/4.0 of IEC/EN 61000-3-3 depend on which standard adopted for compliance measurement.

6.3.2 All types of harmonic current and/or voltage fluctuation in this report are assessed by direct measurement using flicker-meter.

6.3.3 For the actual test configuration, please refer to the related Item –Block Diagram of system tested.

#### 6.4 Test Condition

Temperature	:	25 °C
Relative Humidity	:	48 %
Pressure	:	1010 hPa
Test Power	:	DC 5V

#### 6.5 Test Data

Please see the following pages.

### Flicker Test Summary per EN/IEC61000-3-3 (Run time)

**Test category:** All parameters (European limits)  
**Test Margin:** 100      **Tested by:** LH  
**Start time:** 15:32:33      **End time:** 15:42:54  
**Test duration (min):** 10      **Data file name:** F-000387.cts\_data

**Test Result:** Pass      **Status:** Test Completed

#### Pst<sub>i</sub> and limit line

#### European Limits

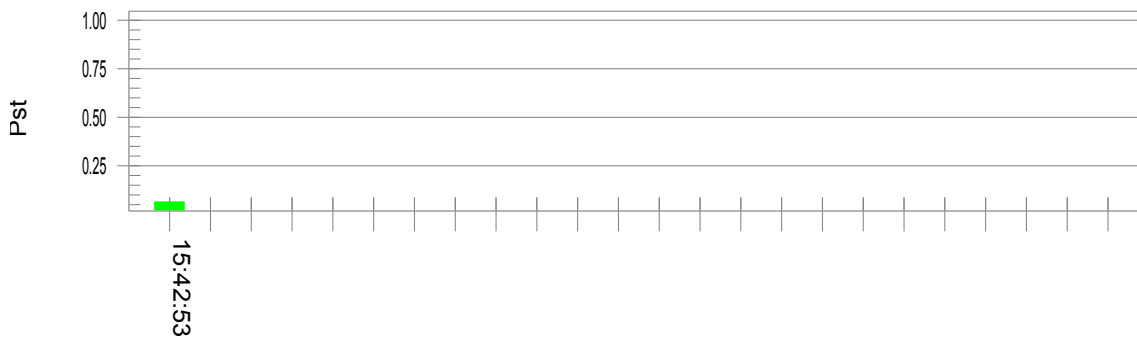

#### Plt and limit line

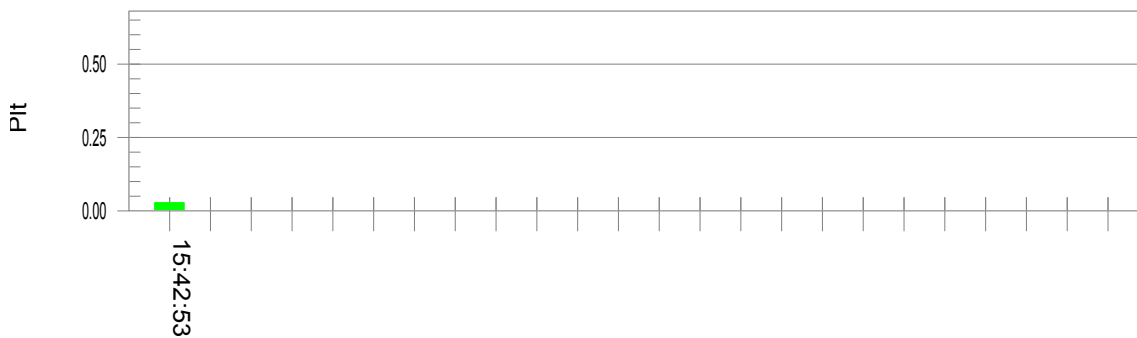

#### Parameter values recorded during the test:

<b>Vrms at the end of test (Volt):</b>	<b>229.81</b>			
<b>Highest dt (%):</b>	<b>0.00</b>	<b>Test limit (%):</b>	<b>3.30</b>	<b>Pass</b>
<b>Time(mS) &gt; dt:</b>	<b>0.0</b>	<b>Test limit (mS):</b>	<b>500.0</b>	<b>Pass</b>
<b>Highest dc (%):</b>	<b>0.00</b>	<b>Test limit (%):</b>	<b>3.30</b>	<b>Pass</b>
<b>Highest dmax (%):</b>	<b>0.00</b>	<b>Test limit (%):</b>	<b>4.00</b>	<b>Pass</b>
<b>Highest Pst (10 min. period):</b>	<b>0.064</b>	<b>Test limit:</b>	<b>1.000</b>	<b>Pass</b>
<b>Highest Plt (2 hr. period):</b>	<b>0.028</b>	<b>Test limit:</b>	<b>0.650</b>	<b>Pass</b>



## 7 Electrostatic Discharge Immunity Test

### 7.1 Test Requirements

#### 7.1.1 Test Standard

ETSI EN 301 489-1 Clause 9.3

ETSI EN 301 489-17

EN 61000-4-2: 2009

#### 7.1.2 Test Level

Level	Test Voltage Contact Discharge (KV)	Test Voltage Air Discharge (KV)
1.	±2	±2
2.	±4	±4
3.	±6	±8
4.	±8	±15
X	Special	Special

#### 7.1.3 Performance criterion: B

### 7.2 Test Setup

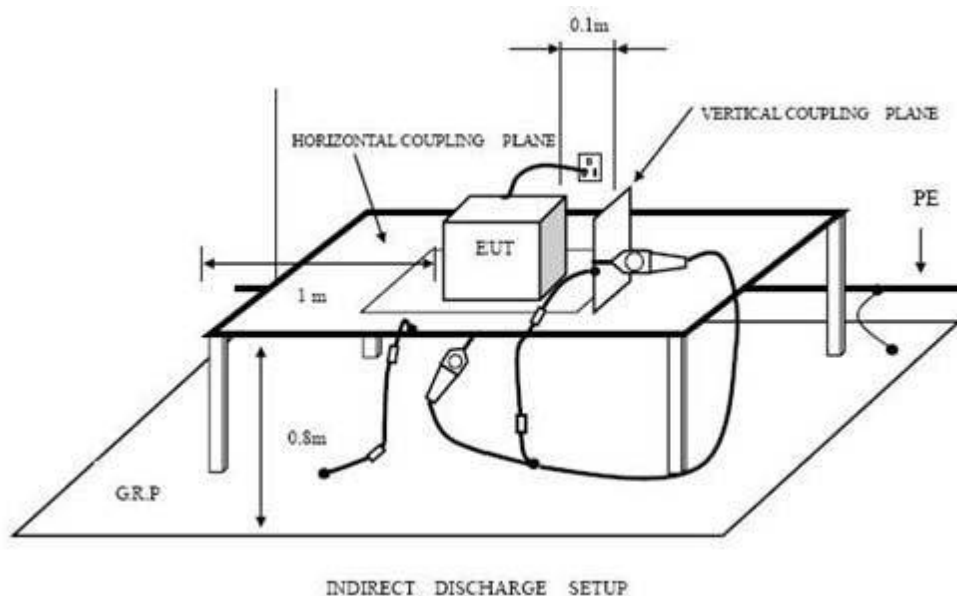

### 7.3 Test Procedure

#### 7.3.1 Air Discharge:

This test is done on a non-conductive surface. The round discharge tip of the discharge electrode shall be approached as fast as possible to touch the EUT. After each discharge,

the discharge electrode shall be removed from the EUT. The generator is then re-triggered for a new single discharge and repeated 10 times for each pre-selected test point. This procedure shall be repeated until all the air discharge completed.

#### 7.3.2 Contact Discharge:

All the procedure shall be same as air discharge. Except that the tip of the discharge electrode shall touch the EUT before the discharge switch is operated.

#### 7.3.3 Indirect discharge for horizontal coupling plane

At least 10 single discharges (in the most sensitive polarity) shall be applied at the front edge of each HCP opposite the center point of each unit (if applicable) of the EUT and 0.1m from the front of the EUT. The long axis of the discharge electrode shall be in the plane of the HCP and perpendicular to its front edge during the discharge.

#### 7.3.4 Indirect discharge for vertical coupling plane

At least 10 single discharges (in the most sensitive polarity) shall be applied to the center of one vertical edge of the coupling plane. The coupling plane, of dimensions 0.5m X 0.5m, is placed parallel to, and positioned at a distance of 0.1m from the EUT. Discharges shall be applied to the coupling plane, with this plane in sufficient different positions that the four faces of the EUT are completely illuminated.

### 7.4 Test Data

Please refer to the following page.

## Electrostatic Discharge Test Result

EUT :	Wifi Repeater	Model Name :	WR
Temperature :	22℃	Humidity :	50%
Power supply :	DC 5V	Test Mode :	Mode 1/2
Test Engineer :	Jim		
<p>Criterion: B</p> <p>Air Discharge: <math>\pm 8kV</math> Contact Discharge: <math>\pm 4kV</math></p> <p>For each point positive 10 times and negative 10 times discharge.</p>			
Location	Kind C- Air Discharge C-Contact Discharge	Result	
Slot of the EUT	A	PASS	
USB Port	A	PASS	
SD Card Port	A	PASS	
Button	A	PASS	
Audio Port	A	PASS	
Screen	A	PASS	
Audio Port	A	PASS	
Enclosure of EUT	C	PASS	
USB Port	C	PASS	
Remark:			

## 8 Radiated Electromagnetic Field Immunity test

### 8.1 Test Requirements

#### 8.1.1 Test Standard

ETSI EN 301 489-1 Clause 9.2  
ETSI EN 301 489-17  
EN IEC 61000-4-3:2020

#### 8.1.2 Test Level

##### Test Level for Radiated Electromagnetic Field Immunity Test

Port	Test Specification
Enclosure Port	80-1000MHz, and 1400-2700MHz 3 V/m 80 % AM (1kHz)

#### 8.1.3 Performance criterion: A

### 8.2 Test Setup

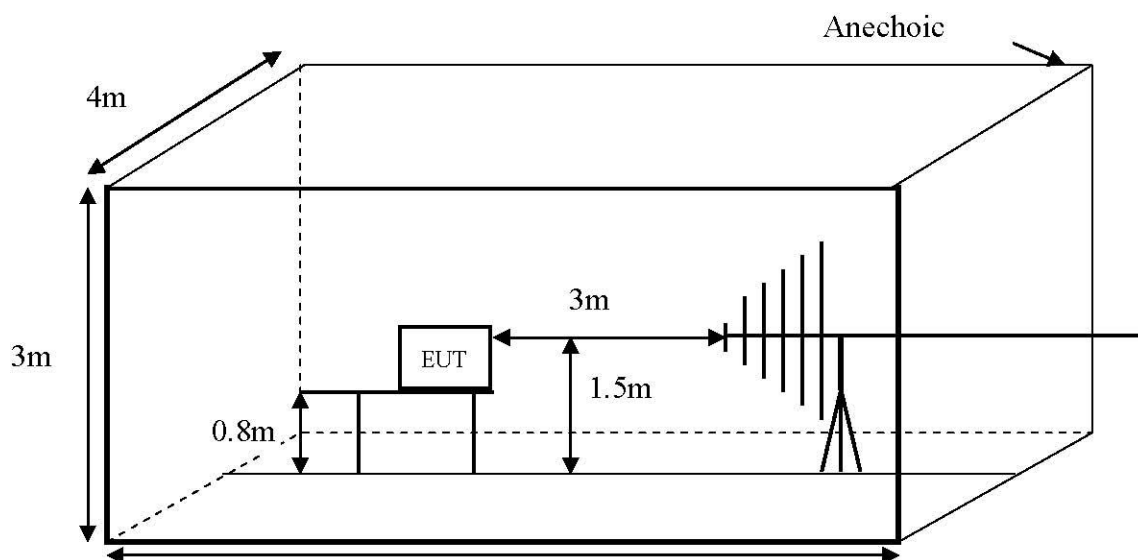

### 8.3 Test Procedure

The EUT are placed on a table, which is 0.8 meter high above the ground. The EUT is set 3 meters away from the transmitting antenna, which is mounted on an antenna tower. Both horizontal and vertical polarization of the antenna is set on test. Each of the four sides of the EUT must be faced this transmitting antenna and measured individually.

In order to judge the EUT performance, a camera is used to monitor its screen.

All the scanning conditions are as following:

<b>Condition of Test</b>	<b>Remark</b>
1. Fielded Strength	3V/m
2. Radiated Signal	80%AM,1kHz Since Wave
3. Scanning Frequency	80-1000MHz,1400-2700MHz
4. Sweep time of radiated	0.0015 Decade/s
5. Dwell Time	3 Sec.

#### 8.4 Test Data

Please refer to the following page.

## RF Field Strength Susceptibility Test Results

EUT :	Wifi Repeater		Model Name :	WR
Temperature :	22°C		Humidity :	50%
Field Strength :	3V/m		Criterion :	A
Power Supply :	DC 5V		Test Mode :	Mode 1/2
Test Engineer:	Jim			
Modulation: <input type="checkbox"/> None <input type="checkbox"/> Pulse <input checked="" type="checkbox"/> AM 1KHz 80%				
	Frequency Rang 1:		Frequency Rang 2:	
	80~ 1000MHz		1400~2700MHz	
	Horizontal	Vertical	Horizontal	Vertical
Front	PASS	PASS	PASS	PASS
Right	PASS	PASS	PASS	PASS
Rear	PASS	PASS	PASS	PASS
Left	PASS	PASS	PASS	PASS
Note:				

## 9 Electrical Fast Transient/Burst Test

### 9.1 Test Requirements

#### 9.1.1 Test Standard

ETSI EN 301 489-1 Clause 9.4  
ETSI EN 301 489-17  
EN 61000-4-4: 2012

#### 9.1.2 Test Level

##### Test Level for Electrical Fast Transient Test

	On Switching Adapter Lines	On I/O (Input/Output) Signal data and control lines
<b>Test Voltage:</b>	1 KV	0.5 KV
<b>Polarity:</b>	Positive & Negative	
<b>Impulse Wave Shape:</b>	5/50ns	
<b>Burst Duration:</b>	15ms	
<b>Burst Period:</b>	300ms	
<b>Test Duration:</b>	Not less than 1 min	

#### 9.1.3 Performance criterion: B

### 9.2 Test Setup

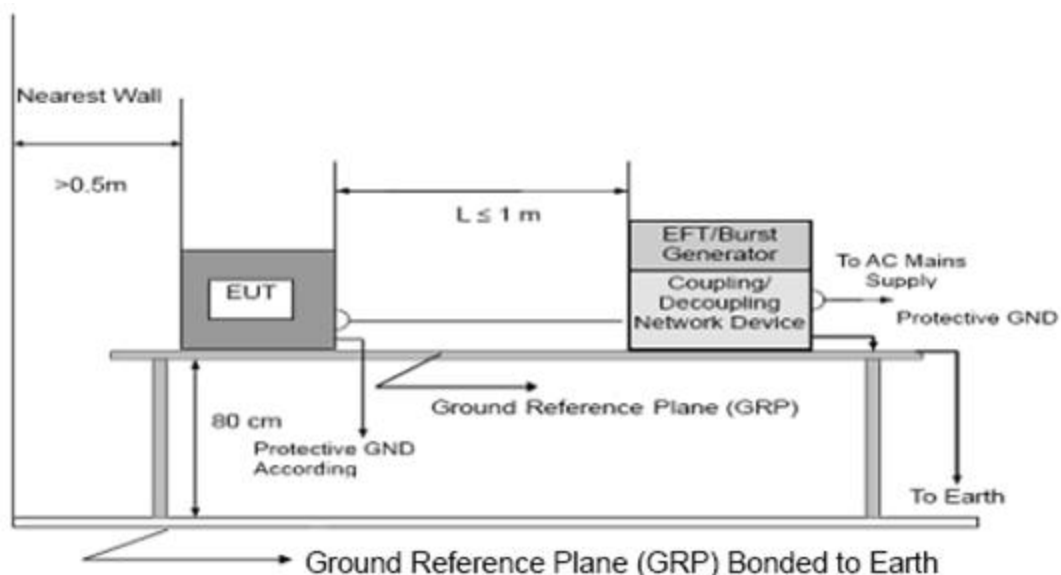

### 9.3 Test Procedure

#### 9.3.1 For input and output AC power ports:

The EUT is connected to the power mains by using a coupling device which couples the EFT interference signal to AC power lines. Both polarities of the test voltage should be applied during compliance test and the duration of the test is 1minute.

9.3.2 For signal lines and control lines ports:

A coupling clamp is use to couple the EFT interference signal to the signal and control lines. Both polarities of the test voltage should be applied during compliance test and the duration of the test is 1 minute.

9.3.3 For DC input and DC output power ports:

The EUT is connected to the power mains by using a coupling device which couples the EFT interference signal to DC power lines. Both polarities of the test voltage should be applied during compliance test and the duration of the test is 1 minute.

## 9.4 Test Data

Please refer to the following page.



## Electrical Fast Transient/Burst Test Results

EUT :	Wifi Repeater	Model Name :	WR
Temperature :	22℃	Humidity:	50%
Power Supply :	DC 5V	Criterion :	B
Test Engineer :	Jim	Test Mode :	Mode 1/2
Test Results Description			
Line : <input checked="" type="checkbox"/> AC Mains Line <input type="checkbox"/> DC Power Line <input type="checkbox"/> Signal <input type="checkbox"/> I/O Cable			
Test Level: <input checked="" type="checkbox"/> 1KV <input type="checkbox"/> 0.5KV			
Port(s)	Polarity	Results	Judgment
Line(L)	P	A	PASS
	N	A	PASS
Neutral(N)	P	A	PASS
	N	A	PASS
Ground(PE)	P	N/A	
	N	N/A	
Signal /Control Line(LAN)	P	N/A	
	N	N/A	
Remark:			

## 10 Surge Immunity Test

### 10.1 Test Requirements

#### 10.1.1 Test Standard

ETSI EN 301 489-1 Clause 9.8  
ETSI EN 301 489-17  
EN 61000-4-5: 2014

#### 10.1.2 Level

##### Test Level for Surge Immunity Test

<b>Basic Standard:</b>	<b>EN 61000-4-5</b>
<b>Wave-Shape:</b>	Combination Wave 1.2/50us Open Circuit Voltage 8/20us Short Circuit Current
<b>Test Voltage</b>	Power Line:0.5kV,1kV,2kV
<b>Surge Input/Output:</b>	L1-I2,I1-PE,L2-PE
<b>Generator Source:</b>	2 ohm between networks
<b>Impedance:</b>	12ohm between network and ground
<b>Polarity:</b>	Positive/Negative
<b>Phase Angle:</b>	0/90/180/270
<b>Pulse Repetition Rate:</b>	1 time/min.(maximum)
<b>Number of Tests:</b>	5 positive and 5 negative at selected points

#### 10.1.3 Performance criterion: B

## 10.2 Test Setup

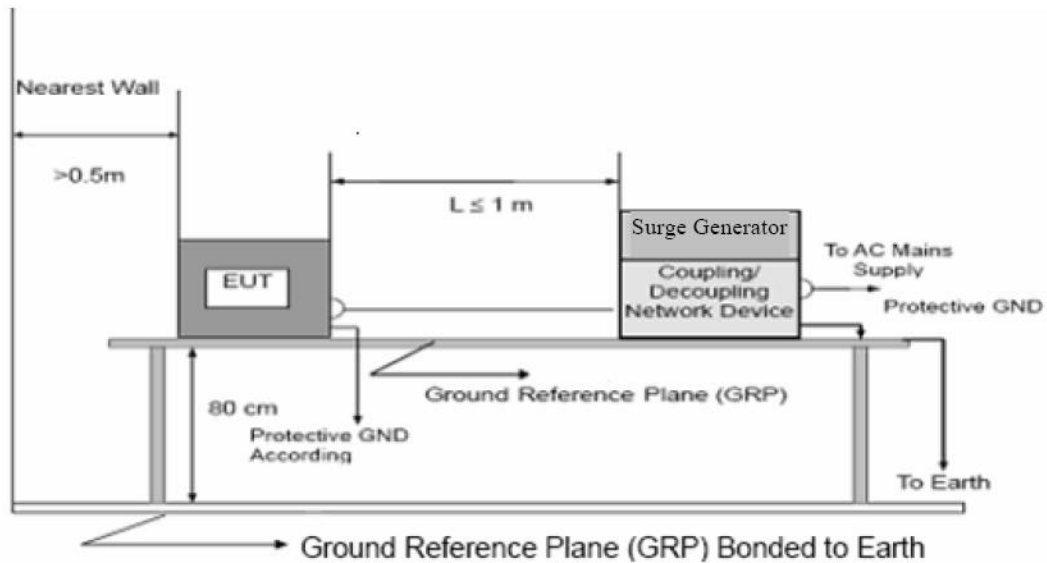

## 10.3 Test Procedure

- 10.3.1 Set up the EUT and test generator.
- 10.3.2 For line to line coupling mode, provide a 1.0 KV 1.2/50us voltage surge
- 10.3.3 (at open-circuit condition) and 8/20us current surge to EUT selected points.
- 10.3.4 At least 5 positive and 5 negative (polarity) tests with a maximum 1/min repetition rate are conducted during test.
- 10.3.5 Different phase angles are done individually.
- 10.3.6 Record the EUT operating situation during compliance test and decide the EUT immunity criterion for above each test.

## 10.4 Test Data

Please refer to the following page.

## Surge Immunity Test Results

EUT :	Wifi Repeater	Model Name :	WR		
Temperature :	22°C	Humidity:	50%		
Power Supply :	DC 5V	Criterion :	A		
Test Engineer :	Jim	Test Mode :	Mode 1/2		
Test Results Description					
Location	Polarity	Phase Angle	No of Pulse	Pulse Voltage (KV)	Result
L-N	±	0	5	1.0	PASS
	±	90	5	1.0	PASS
	±	180	5	1.0	PASS
	±	270	5	1.0	PASS
L-PE	±	0	5	N/A	
	±	90	5	N/A	
	±	180	5	N/A	
	±	270	5	N/A	
N-PE	±	0	5	N/A	
	±	90	5	N/A	
	±	180	5	N/A	
	±	270	5	N/A	
Signal Line (N/A)	±	N/A		N/A	
Remark:					

## 11 Injection Current Test

### 11.1 Test Requirements

#### 11.1.1 Test Standard

ETSI EN 301 489-1 Clause 9.5  
ETSI EN 301 489-17  
EN 61000-4-6: 2014

#### 11.1.2 Test Level

##### Test Level for Conducted Immunity

Port	Test Specification
Input AC power port	0.15MHz~80MHz 3V(r.m.s.) (unmodulated)

#### 11.1.3 Performance criterion: A

### 11.2 Test Setup

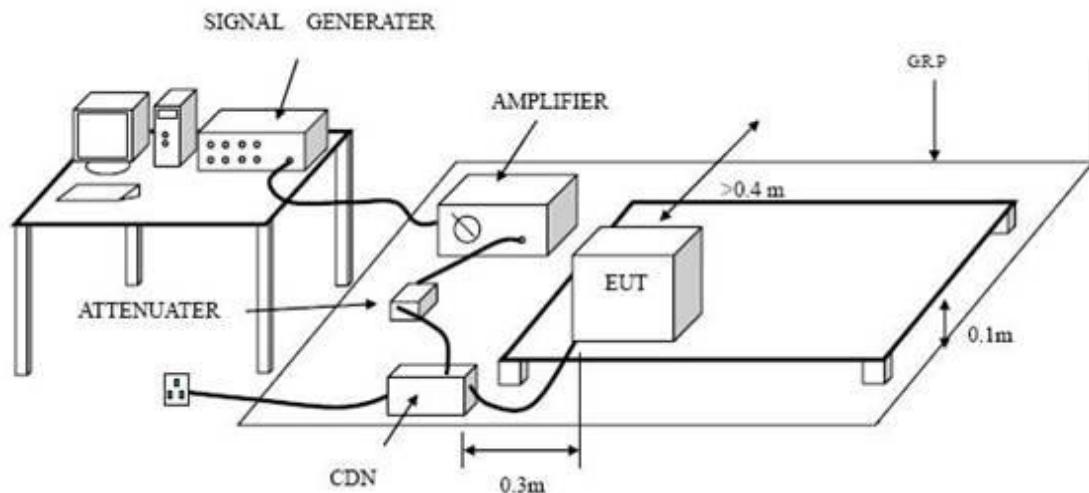

### 11.3 Test Procedure

11.3.1 Set up the EUT, CDN and test generators.

11.3.2 Let the EUT work in test mode and test it.

11.3.3 The EUT are placed on an insulating support 0.1m high above a ground reference plane. CDN (coupling and decoupling device) is placed on the ground plane about 0.3m from EUT. Cables between CDN and EUT are as short as possible, and their height above the ground reference plane shall be between 30 and 50 mm (where possible).

11.3.4 The disturbance signal description below is injected to EUT through CDN.

- 11.3.5 The EUT operates within its operational mode(s) under intended climatic conditions after power on.
- 11.3.6 The frequency range is swept from 0.150MHz to 230MHz using 3V signal level, and with the disturbance signal 80% amplitude modulated with a 1KHz sine wave.
- 11.3.7 The rate of sweep shall not exceed  $1.5 \times 10^{-3}$  decades/s. Where the frequency is swept incrementally, the step size shall not exceed 1% of the start and thereafter 1% of the preceding frequency value.
- 11.3.8 Recording the EUT operating situation during compliance testing and decide the EUT immunity criterion.

#### 11.4 Test Data

Please refer to the following page.

## Injected Currents Susceptibility Test Results

EUT :	Wifi Repeater	Model Name :	WR	
Temperature :	22°C	Humidity:	50%	
Power Supply :	DC 5V	Criterion :	A	
Test Engineer :	Jim	Test Mode :	Mode 1/2	
Test Results Description				
Frequency Range (MHz)	Injected Position	Voltage Level (e.m.f.)	Result	Judgment
0.15 ~ 80	AC Mains	3V(rms),AM Modulated 1000Hz,80%	A	PASS
0.15 ~ 80	DC Mains	3V(rms),AM Modulated 1000Hz,80%	N/A	
0.15 ~ 80	Signal Mains	3V(rms),AM Modulated 1000Hz,80%	N/A	
Remark :				

## 12 Voltage Dips and Interruptions Immunity Test

### 12.1 Test Requirements

#### 12.1.1 Test Standard

ETSI EN 301 489-1 Clause 9.7  
ETSI EN 301 489-17  
EN 61000-4-11: 2004

#### 12.1.2 Level

#### Test Level for Voltage Dips and Interruptions

<b>Basic Standard:</b>	<b>EN 61000-4-11</b>
<b>Required Performance:</b>	B(For 100% Voltage Dips) B(For 100% Voltage Dips) C(For 30% Voltage Dips) C(For 100% Voltage Interruptions)
<b>Test Duration Time:</b>	Minimum three test events in sequence
<b>Interval Between Event:</b>	Minimum ten seconds
<b>Phase Angle:</b>	0°/45°/90°/135°/180°/225°/270°/315°/360°
<b>Test Cycle:</b>	3 times

### 12.2 Test Setup

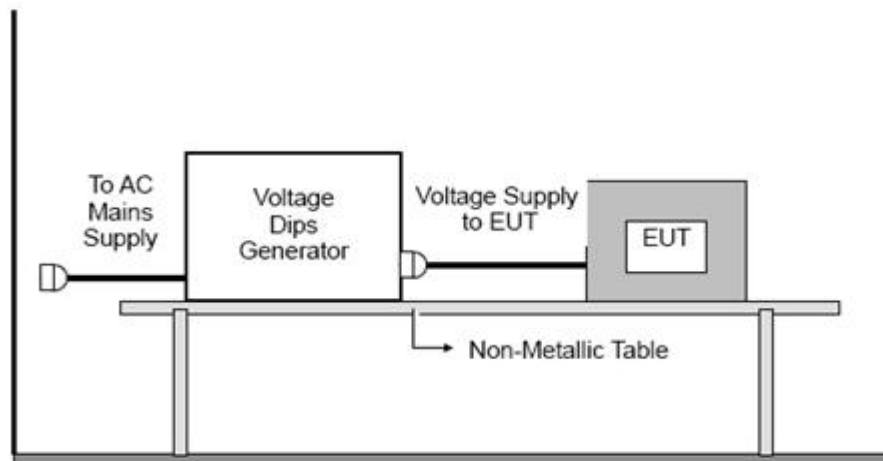

### 12.3 Test Procedure

The EUT shall be tested for each selected combination of test levels and duration with a sequence of three dips/interruptions with intervals of 10 s minimum (between each test event). Each representative mode of operation shall be tested. Abrupt changes in supply voltage shall occur at zero crossings of the voltage waveform.



12.4 Test Data

## Voltage Dips and Interruptions Test Results

EUT :	Wifi Repeater	Model Name :	WR	
Temperature :	22℃	Humidity :	50%	
Power Supply :	DC 5V	Criterion :	B&C	
Test Engineer :	Jim	Test Mode :	Mode 1/2	
Test Results Description				
Voltage Reduction	Cycles	Perform Criteria	Results	Judgment
Voltage dip 100%	0.5	B	A	PASS
Voltage dip 100%	1	B	A	PASS
Voltage dip 30%	25	C	B	PASS
Voltage Interruption 100%	250	C	C	PASS
Remark:				

## 13 Photographs - Constructional Details

Photo 1 Appearance of EUT

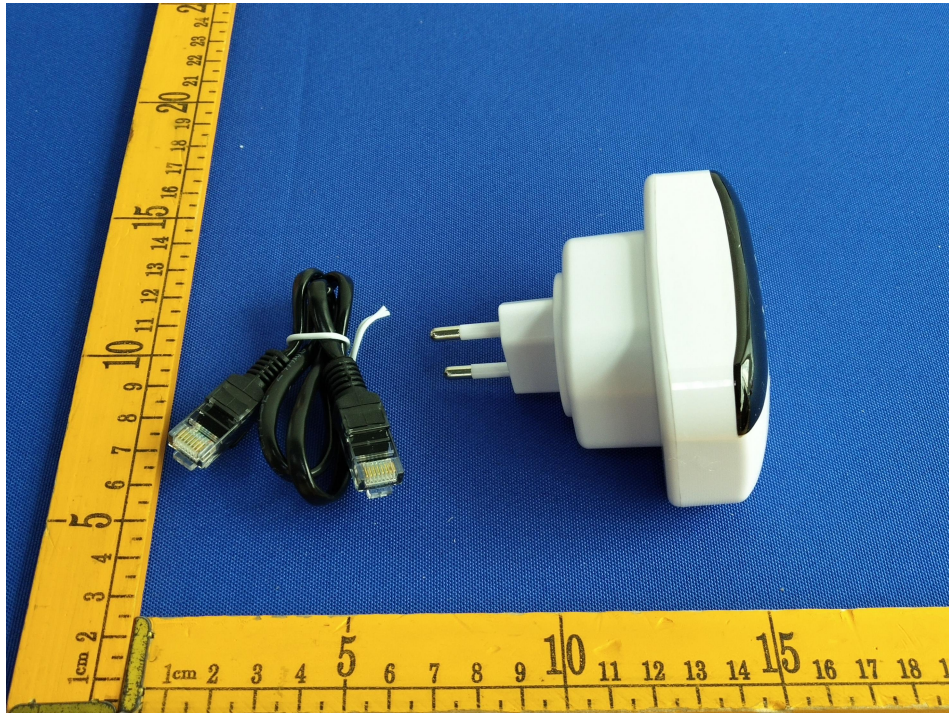

Photo 2 Appearance of EUT





Photo 3 Appearance of EUT



End Of Report