

Instant Pot®

DUO™ NOVA Multi-Use Pressure Cooker

Welcome

Initial Set-up

Getting Started

Venting Methods

Initial Test Run (Water Test)

More Controls and Smart Programmes

Support and Contact Information



Getting Started Guide

Full Manual, How to Videos and Recipes available online at instantpot.co.uk
Register your product today at instantpot.co.uk/support/register-your-product/

Welcome to the world of Instant cooking.

As the new owner of an Instant Pot® Duo™ Nova 7-in-1 Multi Pressure Cooke, we'd like to welcome you to the Instant Community. At Instant Brands™, we are committed to helping homechefs worldwide to cook healthier, and get delicious meals on the table, quicker and easier than ever before. Our multifunctional cooking appliances will ignite your passion for making mealtimes amazing. We have created a world of cooking resources to help you on your journey to create a variety of culinary masterpieces at home.



Download the **Instant Pot app** to access 1000+ recipe ideas.



Join other Instant home chefs on the **Instant Pot UK community on Facebook** for tips, tricks, and inspiration from the recipes they have created.



Subscribe to our e-newsletter to receive regular recipe e-books and find your next dinner favourite.



And of course, we want to hear from you, so don't forget to tag us online **@instantpotuk** and share your experiences and the dishes you create using **#InstantChefAtHome** **#instantpot**.

The Instant Pot® simplifies the joys of home cooking. The Duo™ Nova does everything you can do with 7 other appliances: pressure cooker, sauté pan, steamer, slow cooker, rice cooker, food warmer, and yogurt maker. Clear the clutter from your counter and do it all with just one tool.

If you have any comments or queries, please get in touch with us via the helpdesk on www.instantpot.co.uk/support/instant-pot-help-desk/ or by sending an email to EUSupport@instantbrands.com. You may also find the Frequently Asked Questions page on our website useful, which answers common Pressure Cooking questions. Finally, don't forget to register your appliance online, simply head to www.instantpot.co.uk.

Initial Set-up

- Read all Important Safeguards in the included Safety, Maintenance and Warranty booklet before use. Failure to do so may result in property damage and/or personal injury.
- Use ONLY the Instant Pot® Duo™ Nova lid with the Instant Pot® Duo™ Nova pressure cooker. Using any other pressure cooker lids may cause injury and/or damage.
- Follow Care and Cleaning instructions in the included Safety, Maintenance and Warranty booklet to wash the cooker before first use. Failure to do so may result in property damage and/or personal injury.
- Remove all packaging material from in and around the cooker, and verify that all parts are accounted for.
- Place the cooker on a stable, level surface, away from external heat sources.
- Do not remove safety warning stickers from lid, serial number from bottom, or rating label from back of cooker base.



Never use the cooker on a hob. Do not place appliance on or in close proximity to a hot gas or electric burner, or a hot oven. Heat from an external source will damage appliance.

Cooker Parts Overview

Top of Lid

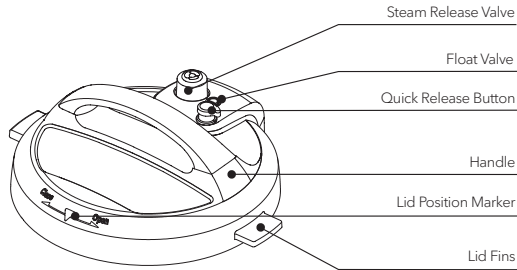

Bottom of Lid

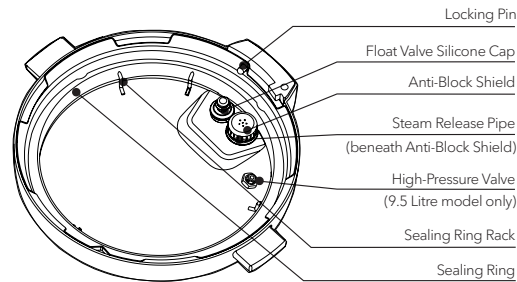

Inner Pot

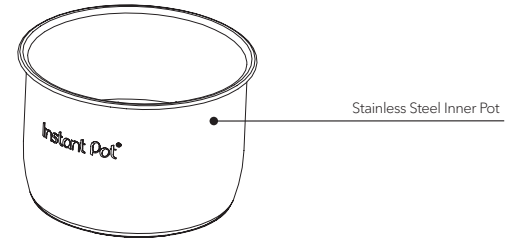

Cooker Base

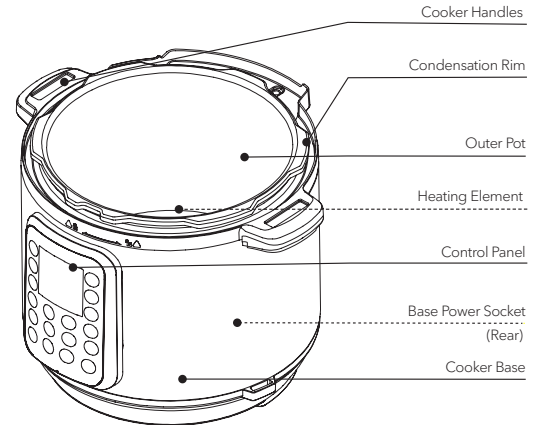

CAUTION The high-pressure valve is a safety mechanism that vents excess pressure only when necessary. Do not touch the high-pressure valve during operation to avoid personal injury

Images are for reference only. Refer to actual product.

1

Open and Close Lid

When cooker is plugged in, it will play a jingle when lid is opened and closed.

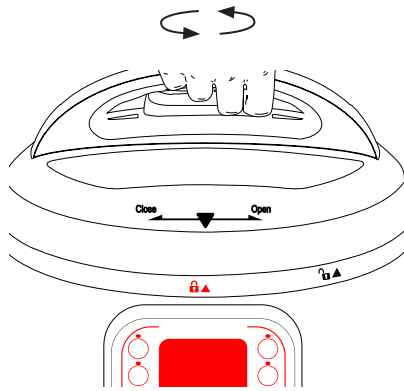

Open

Open: Grip handle and turn lid anti-clockwise until ▼ on lid is aligned with ▲ indicator on the rim of cooker base. Lift lid up and off cooker base.

Note: Always check lid for damage prior to cooking.

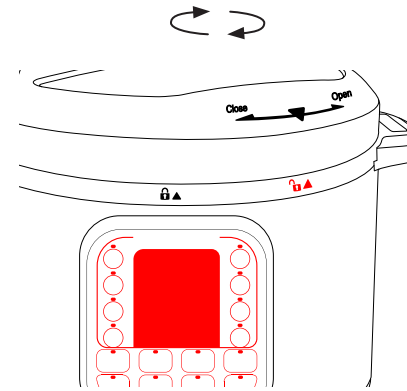

Close

Close: Grip handle and align the ▼ on lid with ▲ indicator on rim of cooker base. Lower lid into track then turn lid clockwise until ▼ on the lid lines up with ▲ indicator on base.

2

Check Sealing Ring and Sealing Ring Rack

Remove: Pull sealing ring out from behind sealing ring rack.

Inspect sealing ring rack. It should be centred in the lid and an even height all the way around.

Sealing ring must be installed before use and cleaned after each use.

Install: Place sealing ring over sealing ring rack and press into place. Ensure **entire** sealing ring is snug behind sealing ring rack.

After closing the lid, the sealing ring creates an airtight seal between lid and cooker base. The sealing ring is an integral part of product safety.

Only one sealing ring should be installed when using your cooker. Replace your sealing ring every 12-18 months or when deformation or damage is noticed.



Always check for cuts or deformations in sealing ring prior to cooking. Only use authorised Instant Pot® sealing rings. Failure to follow these instructions may cause food to discharge, which may lead to personal injury or property damage.



Sealing rings may stretch over time. Do not use a stretched or damaged sealing ring. If puckering occurs, replace sealing ring.

To check or clean the parts in Steps 2-7, please make sure the unit is unplugged and cool before performing any of these tasks.

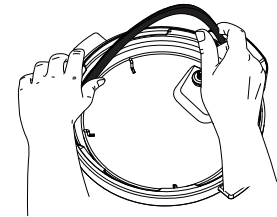

Remove

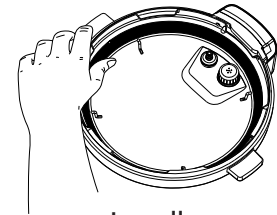

Install

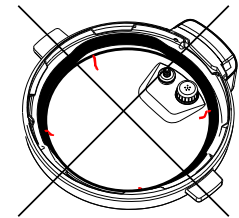

3

Remove and Install Float Valve

The float valve has 2 positions. It **pops up** to indicate when the cooker is pressurised and **lowers into the lid** when the cooker is **depressurised**.

Remove: Place one finger on the flat **top** of the float valve. Turn lid over. Detach silicone cap from the **bottom** side of the float valve. Remove float valve from **top** of lid. Do not discard float valve or silicone cap.

The float valve and silicone cap must be installed before use to seal in pressurised steam.

Install: Drop float valve into float valve hole on **top** of lid. Place one finger on the flat top of float valve. Turn lid over. Attach silicone cap to **bottom** of float valve. Refer to “Venting Methods” in this guide for information on releasing pressure.

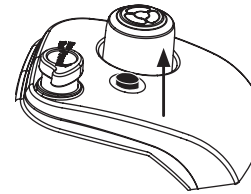

Pressurised

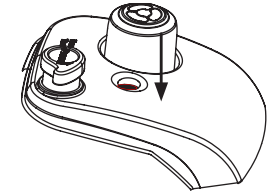

Depressurised

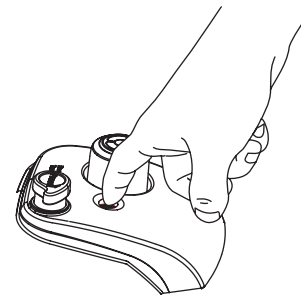

Top

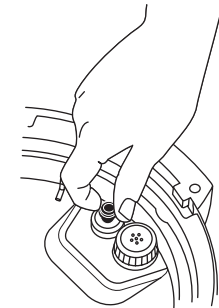

Bottom



WARNING

While float valve is **up**, contents of cooker are pressurised. **Do not attempt to remove lid.** Refer to “Venting Methods” section in this guide for information on releasing pressure. Failure to comply with this instruction could cause injuries or property damage.

4

Remove and Install Anti-Block Shield

Remove: Grip lid and press firmly against side of anti-block shield (pressing towards side of lid and up) until it pops off the prongs underneath.

Anti-block shield must be installed before use and cleaned after each use.

Install: Place anti-block shield over prongs and press down until it snaps into position.

Anti-block shield prevents food particles from coming up through the steam release pipe, assisting with pressure regulation.

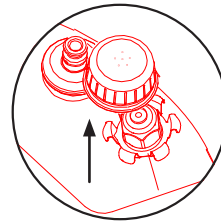
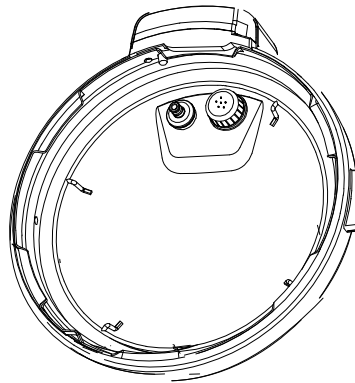

Remove

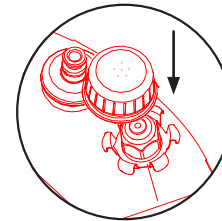

Install

5

Remove and Install Steam Release Assembly

Remove: Pull steam release valve up and off steam release pipe.

Steam release valve must be installed before use and cleaned after each use.

Install: Place steam release valve on steam release pipe and press down.
Fits loosely when installed properly but will remain in place when the lid is turned over.

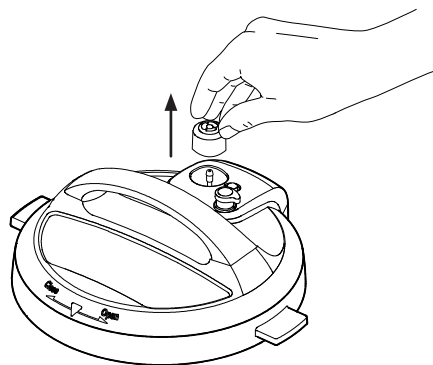

Remove

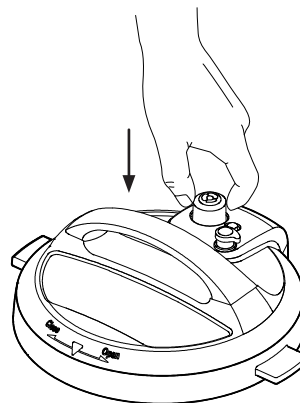

Install

6

Remove and Clean Inner Pot

Remove inner pot from cooker base and wash with hot water and washing up liquid before first use. Wipe outer surfaces of inner pot and heating element to ensure they are dry and free of food debris. Failure to do so may damage the cooker.

Place inner pot into cooker base before cooking. Food must be placed only in the inner pot, not cooker base.

The inner pot is an integral part of product safety. Always use an authorised Instant Pot® inner pot made for this model when cooking. Failure to do so may cause personal injury or property damage.

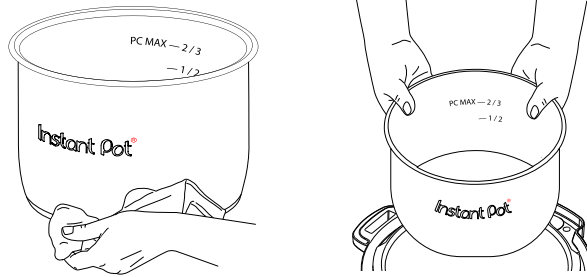

**Note: Always check inner pot for dents or deformations prior to cooking.*

CAUTION

To avoid risk of personal injury and/or property damage, do not pour food or liquid into cooker base.

WARNING

Do not fill the inner pot higher than the **PC MAX — 2/3 line** (Pressure Cooking Maximum), as indicated on the inner pot.

Exercise extreme caution when cooking and venting food such as stewed apples, cranberries, pearl barley, oatmeal, split peas, noodles, etc., as these foods may foam, froth or spatter, and may clog the steam release pipe and/or steam release valve. Do not fill the inner pot higher than the **— 1/2 line** when cooking these foods.

7

Install Condensation Collector

Install: On back of cooker base, align grooves on condensation collector over tabs and push condensation collector into place.

The condensation collector accumulates excess water and should be installed before cooking. Clean after use.

Remove: Pull condensation collector away from cooker base. Do not pull down on condensation collector.

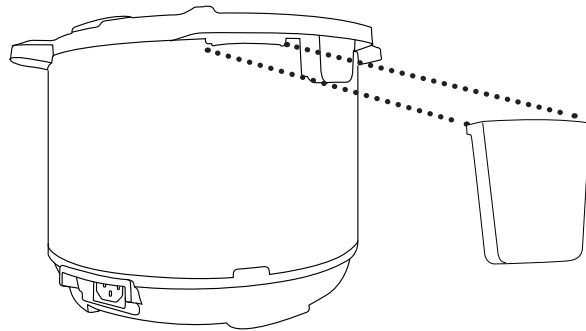

Venting Methods

When closing the lid, the quick release button will automatically reset to the popped-up “Seal” position.

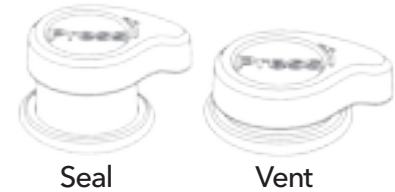

Natural Release (NR)

Leave the steam release in the “Seal” position (up). The cooker dissipates heat so pressure releases naturally over time.

This method must be used when cooking food such as soups, stews or chilis, as well as food that expands, such as beans and grains.

Note: Depressurisation time will vary based upon volume of food and liquid. May take 10-40 minutes, or longer.

Quick Release (QR)

Vent: Press quick release button down until it clicks. When depressed, a continuous stream of steam will be released through the steam release valve until the float valve drops into the lid.

Note: It will be loud!

If spatter occurs, flick quick release button to reset it to the “Seal” position, and try again after a few minutes. If spatter continues, use NR to vent remaining pressure.

Seal: Flick quick release button to reset it to the popped-up “Seal” position.

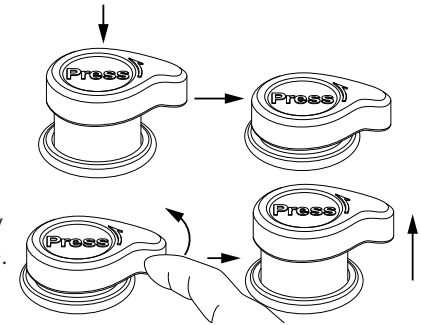

⚠ WARNING

Do not lean over the steam release valve.	Do not place unprotected skin over the steam release valve.	Do not cover the steam release valve.	The float valve drops when the cooker has depressurised. Do not attempt to open the lid while the float valve is still popped up. Failure to follow these instructions may lead to injury or damage.	The Duo Nova 9.5 Litre model has a high-pressure valve. This is a safety mechanism that vents excess pressure only when necessary. Do not touch the high-pressure valve during operation to avoid personal injury.
---	---	---------------------------------------	--	--

Initial Test Run (Water Test)

1. Add 750 ml water to inner pot.
2. Insert inner pot into cooker base.
3. Secure power lead to base connection socket. Ensure connection is tight.
Connect power lead to a 220~240 V power source.
Display indicates "OFF".
4. Align ▼ on lid with ▲ on cooker base.
Lower lid into track, then turn lid clockwise until jingle sounds. Steam release automatically resets to "Seal" position when the lid is closed.
5. Select Smart Programme: **Pressure Cook**.
6. Use + / - keys to adjust cooking time to "00:05" minutes.

Note: The Instant Pot will save any customisation made to cooking time.

After 10 seconds, display indicates "On" and cooker begins **Pre-heating**.

7. Float valve rises when cooker has pressurised.
Once pressurised, **Cooking** begins and display changes from "On" to cooking time countdown.
8. When the Smart Programme is completed, cooker begins **Keep Warm** or display indicates "End".
9. Press quick release button down until it clicks into "Vent" position.
Pressurised steam will release through top of steam release valve.
Float valve will drop when pressure has been fully released.
10. To open, turn the lid anti-clockwise until a jingle sounds.
11. Discard water and dry inner pot.
12. Start cooking!

For details on Smart Programmes and operating instructions, view the full manual at instantpot.co.uk.

More Controls

- Cancel** Press to stop a Smart Programme at any time. Cooker returns to Standby and displays **"OFF"**.
- Delay Start** Postpone cooking up to 24 hours. Select a Smart Programme and, if desired, adjust the cooking time, then press **Delay Start** to turn the setting on. Use the **+ / -** keys to adjust the number of hours before cooking will begin.
- Keep Warm** Setting is on by default on all Smart Programmes except **Sauté** and **Yogurt**. Once Smart Programme is selected, press **Keep Warm** to turn the setting off.
- Sound On** When in Standby, press and hold **"+"** key until display indicates **"S On"**.
- Sound Off** When in Standby, press and hold **"-"** key until display indicates **"SOFF"**.
- Note: Error code alerts cannot be silenced.*

Smart Programmes

Smart Programme	Setting	Suggested Use	Note
Soup/Broth	Less	Soup without meat	Liquid remains clear due to lack of boiling motion. Always use NR to release pressure when cooking soup with a high starch content.
	Normal	Soup with meat	
	More	Rich bone broth	
Meat/Stew	Less	Soft texture	Choose setting based on meat texture desired, or adjust cooking time manually. Allow meat to "rest" for 5-30 minutes (depending on size), either in the cooker or covered.
	Normal	Very soft texture	
	More	Fall-off-the-bone texture	
Beans/Chili	Less	Firmer texture	Choose setting based on desired bean texture, or adjust cooking time manually. When cooking beans or legumes, always use NR to release pressure. Ensure dry beans are completely submerged in water.
	Normal	Soft texture	
	More	Very soft texture	
Poultry*	Less	Soft texture	Choose setting based on meat texture desired, or adjust cooking time manually. Allow poultry to "rest" for 5-10 minutes (depending on size), either in the cooker or covered.
	Normal	Very soft texture	
	More	Fall-off-the-bone texture	
Rice	Less	Tender but firm to bite	Depending on the volume of rice, cooking time may range from 8-15 minutes. After cooking, wait 10 minutes then use QR to vent.
	Normal	Normal texture white rice	
	More	Softer texture white rice	
Multigrain*	Less	Brown rice, wild rice, black beans, chickpeas, etc.	Select " Less " or " Normal " based on type of grain and desired texture. " More " begins with 45 minutes of warm water soaking time prior to 60 minutes of pressure cooking.
	Normal	Brown rice, wild rice, mung beans, etc.	
	More	Tough grains or a mixture of grains and beans	

*Not available on 3 Litre size. Use **Pressure Cook** instead.

Smart Programme	Setting	Suggested Use	Note
Porridge	Less	Oatmeal—coarse or rolled	Adjust time as directed in recipe. Always use NR to release pressure when cooking foods that expand.
	Normal	White rice porridge/congee	
	More	Rice porridge/congee with a mixture of various grains	
Steam	Less	Vegetables	Use steam rack provided to elevate food from cooking liquid. Use QR to prevent food from overcooking.
	Normal	Fish and seafood	
	More	Meat	
Pressure Cook	Less	Manual programming	Press Pressure Level to toggle between High and Low pressure. Use + / - keys to adjust cooking time. Adjust according to recipe for desired results.
	Normal		
	More		
Slow Cook	Less	Corresponds to Low on standard slow cookers	Ensure quick release button is set to “ Vent ” position. Alternatively, use a glass lid for slow cooking.
	Normal	Corresponds to Medium on standard slow cookers	
	More	Corresponds to High on standard slow cookers	
Sauté	Less	Simmering and reducing	Do not use the lid on Sauté. Maximum 30 minutes to prevent overheating. When display switches from “ On ” to “ Hot ”, add recipe ingredients. If ingredients are added before “ Hot ” message appears, it may not appear at all.
	Normal	Pan searing or sautéing	
	More	Stir-frying or browning meat	
Yogurt	Less	Low-temperature fermentation (Jiu Niang)	Milk must reach a minimum of 72°C for pasteurisation to occur. Allow pasteurised milk to cool to below 43°C. 8 hours is standard for fermentation, but a longer period will result in tangier yogurt.
	Normal	Fermenting yogurt	
	More	Pasteurising milk	

Pressure cooking Smart Programmes operate at **High** (70 - 80 kPa) or **Low** (40 - 50 kPa) pressure. Higher pressure results in higher temperature.







Enjoy time well spent with the Instant family of small appliances.

Instant Pot

Instant Brands (EMEA) Limited,
1 Christchurch Way,
Woking, Surrey,
GU21 6JG, UK.

Register your product today at:
instantpot.co.uk/support/register-your-product/
Contact Customer Care:
+44 (0) 3331 230051
UKSupport@instantbrands.com

Subscribe to our newsletter

instantpot.co.uk

Made in China

Join the Official Instant Pot® Community:
www.facebook.com/groups/InstantPotUKCommunity

Download Free App:



 @instantpotUK

 @instantpotUK

 @InstantpotUK

 @InstantpotUK

 @InstantBrandsUK

802-0319-91