

BenQ



**MOUSE FOR
e-SPORTS**

User Guide

S Series

Top view

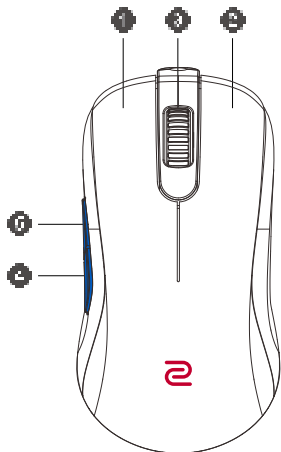

Bottom view

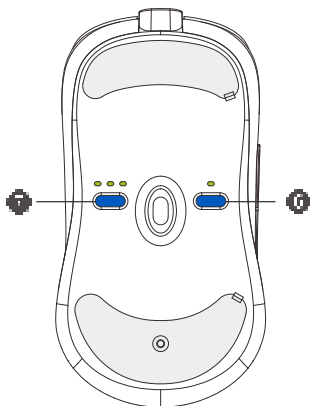

Report rate switch button (⚙)

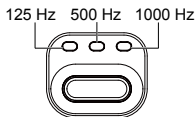

DPI switch button (⚙)



- 400 dpi
- 800 dpi
- 1600 dpi
- 3200 dpi

FK-B Series

Top view

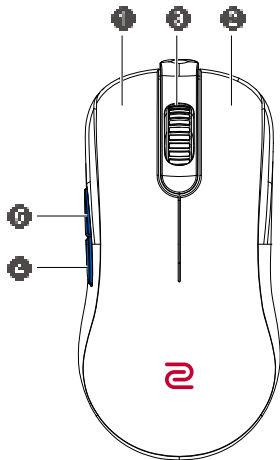

Bottom view

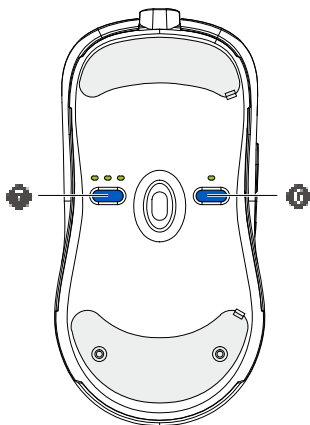

Report rate switch button (1)

125 Hz 500 Hz 1000 Hz

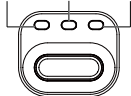

DPI switch button (2)



- 400 dpi
- 800 dpi
- 1600 dpi
- 3200 dpi

ZA-B Series

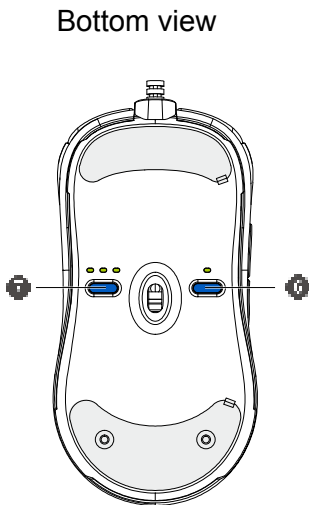
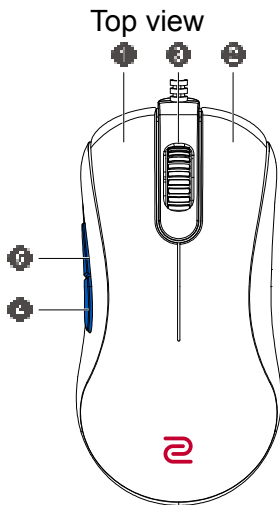

Report rate switch button (⚙️)

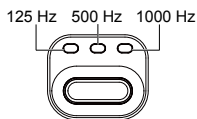

DPI switch button (⚙️)



- 400 dpi
- 800 dpi
- 1600 dpi
- 3200 dpi

Specifications

- No driver needed.
- DPI (Dots per inch) settings: 400 / 800 / 1600 / 3200 dpi
- Adjustable USB report rate: 125 / 500 / 1000 Hz
- Connector: USB
- Buttons: 7 buttons
- Cable length: 2 meters (6.6 feet)

Changing DPI setting

Press the DPI switch button (labeled ) to switch to a desired DPI setting.

Adjusting USB report rate

Press the Report rate switch button (labeled ) to switch to a desired report rate setting.

Note: Illustrations here in this document are for reference only and may differ from the actual products available to you.

Spécifications

- Aucun pilote nécessaire.
- Réglages DPI (Dots per inch) : 400/800/1600/3200 dpi
- Taux de rapport USB réglable : 125/500/1000 Hz
- Connecteur : USB
- Boutons : 7 boutons
- Longueur du câble : 2 mètres (6,6 pieds)

Changer le réglage DPI

Appuyez le bouton commutateur DPI (marqué ) pour passer à un réglage DPI souhaité.

Régler le taux de rapport USB

Appuyez le bouton commutateur de taux de rapport (marqué ) pour passer à un réglage du taux de rapport souhaité.

Technische Daten

- Kein Treiber erforderlich.
- DPI (Dots per inch) Einstellungen: 400/800/1600/3200 dpi
- Anpassbare USB Abtastrate: 125/500/1000 Hz
- Anschluss: USB
- Tasten: 7 Tasten
- Kabellänge: 2 Meter (6,6 Fuß)

DPI Einstellung ändern

Drücken Sie auf die DPI Wechseltaste (gekennzeichnet mit ) , um zu einer gewünschten DPI Einstellung zu wechseln.

USB Abtastrate anpassen

Drücken Sie auf die Abtastrate Wechseltaste (gekennzeichnet mit ) , um zu einer gewünschten Abtastrateneinstellung zu wechseln.

Specifiche

- Nessun driver necessario.
- Impostazioni DPI (Dots per inch): 400/800/1600/3200 dpi
- Frequenza rapporti USB regolabile: 125/500/1000 Hz
- Connettore: USB
- Pulsanti: 7 pulsanti
- Lunghezza cavo: 2 metri (6,6 piedi)

Modifica delle impostazioni DPI

Premere il pulsante di attivazione DPI (indicato dal ) per passare all'impostazione DPI desiderata.

Regolazione della frequenza rapporti USB

Premere il pulsante Frequenza rapporto (indicato dal ) per passare all'impostazione della frequenza rapporto desiderata.

Especificaciones

- No requiere controlador.
- Ajuste DPI (Dots per inch): 400/800/1600/3200 dpi
- Frecuencia de informes USB regulable: 125/500/1000 Hz
- Conector: USB
- Botones: 7 botones
- Longitud del cable: 2 metros (6,6 pies)

Cambio del ajuste DPI

Pulsar el botón de cambio DPI (etiquetado ) para cambiar a un ajuste DPI deseado.

Ajuste de la frecuencia de informes USB

Pulsar el botón de cambio Frecuencia de informes (etiquetado ) para cambiar a un ajuste de frecuencia de informes deseado.

Nota: las ilustraciones del presente documento se facilitan sólo a modo de referencia, pudiendo diferir de los productos actuales que estén a su disposición.

Especificações

- Não necessita de controlador.
- Definições DPI (Dots per inch): 400/800/1600/3200 dpi
- Taxa de relação USB ajustável: 125/500/1000 Hz
- Conector: USB
- Botões: 7 botões
- Comprimento do cabo: 2 metros (6,6 pés)

Alterar a definição DPI

Prima o botão do interruptor DPI (etiqueta ) para alternar para a definição DPI pretendida.

Ajustar a taxa de relação USB

Premir o botão do interruptor da taxa de relação (marca ) para comutar para a definição de taxa de relação pretendida.

Specificaties

- Geen stuurprogramma nodig.
- DPI-instellingen (Dots per inch): 400/800/1600/3200 dpi
- Aanpasbare usb-meldingsfrequentie: 125/500/1000 Hz
- Aansluiting: USB
- Knoppen: 7 knoppen
- Kabellengte: 2 meter (6,6 voet)

DPI-instelling wijzigen

Druk op de DPI-schakelknop (met het label ) om naar een gewenste DPI-instelling te schakelen.

Aanpasbare usb-meldingsfrequentie

Druk op de Meldingsfrequentie-schakelknop (met het label ) om naar een gewenste meldingsfrequentie te schakelen.

Specifikationer

- Driver ikke nødvendig.
- DPI (Dots per inch)-indstillinger: 400/800/1600/3200 dpi
- Justerbar USB-opdateringshastighed: 125/500/1000 Hz
- Stik: USB
- Knapper: 7 knapper
- Kabellængde: 2 meter (6,6 fod)

Ændring af DPI-indstilling

Tryk på skifteknappen for DPI (mærket ) for at skifte til en ønsket DPI-indstilling.

Justering af USB-opdateringshastighed

Tryk på skifteknappen for opdateringshastighed (mærket ) for at skifte til en ønsket indstilling for opdateringshastighed.

Määrittelyt

- Ajuria ei tarvita.
- DPI (Dots per inch) -asetukset: 400/800/1600/3200 dpi
- Säädetty USB-raportoinnin taajuus: 125/500/1000 Hz
- Liitin: USB
- Painikkeet: 7 painiketta
- Kaapelin pituus: 2 metriä (6,6 jalkaa)

DPI-asetusten muuttaminen

Paina DPI-vaihtopainiketta (merkitty ) vaihtaaksesi haluttuun DPI-asetukseen.

USB-raportointitaajuuden muuttaminen

Paina Raportointinopeuden kytkentäpainiketta (merkitty ) vaihtaaksesi haluttuun raportointinopeusasetukseen.

Spesifikasjoner

- Ingen driver nødvendig.
- DPI- (Dots per inch) innstillinger: 400/800/1600/3200 dpi
- Justerbar USB-rapportfrekvens: 125/500/1000 Hz
- Kontakt: USB
- Knapper: 7 knapper
- Kabellengde: 2 meter (6,6 fot)

Endring av DPI-innstilling

Trykk på DPI-bryterknappen (merket ) for å bytte til ønsket DPI-innstilling.

Justering av USB-rapportfrekvens

Trykk på Rapportfrekvens-bryterknappen (merket ) for å bytte til ønsket rapportfrekvensinnstilling.

Specifikationer

- Ingen drivrutin krävs.
- Inställning DPI (Dots per inch): 400/800/1600/3200 dpi
- Justerbar USB-rapportfrekvens: 125/500/1000 Hz
- Anslutning: USB
- Knappar: 7 knappar
- Kabellängd: 2 meter (6,6 fot)

Ändrar DPI-inställning

Tryck på DPI-växlingsknappen (märkt ) för att växla till önskad DPI.

Justerar USB-rapportfrekvens

Tryck på växlingsknappen för rapportfrekvens (märkt ) för att växla till önskad inställning för rapportfrekvens.

Technické údaje

- Není zapotřebí žádný ovladač.
- Nastavení DPI (Dots per inch): 400/800/1600/3200 dpi
- Nastavitelná komunikační frekvence USB: 125/500/1000 Hz
- Konektor: USB
- Tlačítka: 7 tlačítek
- Délka kabelu: 2 metry (6,6 stop)

Změna nastavení DPI

Stiskněte tlačítko pro přepínání DPI (označené ) pro přepnutí na požadované nastavení DPI.

Nastavení komunikační frekvence USB

Stiskněte tlačítko pro přepínání komunikační frekvence (označené ) pro přepnutí na požadované nastavení komunikační frekvence.

Műszaki adatok

- Nincs szükség meghajtóra.
- DPI (Dots per inch) beállítások: 400/800/1600/3200 dpi
- Állítható USB-frissítés: 125/500/1000 Hz
- Csatlakozó: USB
- Gombok: 7 gomb
- Kábel hossza: 2 méter (6,6 láb)

A DPI beállítás módosítása

Nyomja meg a DPI kapcsoló gombot ( jelöléssel van ellátva), hogy átváltson a kívánt DPI beállításra.

Az USB-frissítés beállítása

Nyomja meg a Frissítés kapcsoló gombot ( jelöléssel van ellátva), hogy átváltson a kívánt frissítés beállításra.

Dane techniczne

- Sterownik nie jest wymagany.
- Ustawienia DPI (ang. Dots per inch): 400/800/1600/3200 dpi
- Regulowana częstotliwość próbkowania USB: 125/500/1000 Hz
- Złącze: USB
- Przyciski: 7 przycisków
- Długość kabla: 2 metry (6,6 stopy)

Zmiana ustawienia DPI

Naciśnij przycisk przełączania DPI (oznaczony ) , aby przełączyć na żądane ustawienie DPI.

Ustawianie częstotliwości próbkowania USB

Naciśnij przycisk przełączania częstotliwości próbkowania (oznaczony ) , aby przełączyć na żądane ustawienie częstotliwości próbkowania.

Uwaga: Ilustracje znajdujące się w niniejszym dokumencie stanowią jedynie przykład i mogą różnić się od rzeczywistych produktów dostępnych w sprzedaży.

Specificații

- Nu necesită driver.
- Setări DPI (Dots per inch): 400/800/1600/3200 dpi
- Frecvență raportare USB reglabilă: 125/500/1000 Hz
- Conector: USB
- Butoane: 7 butoane
- Lungime cablu: 2 metri (6,6 picioare)

Modificarea setării DPI

Apăsăți butonul de comutare DPI (etichetat ) pentru a comuta la setarea DPI dorită.

Reglarea frecvenței de raportare USB

Apăsăți butonul de comutare Frecvență raportare (etichetat ) pentru a comuta la setarea dorită pentru frecvența de raportare.

Характеристики

- Драйвера не нужны.
- Настройки DPI (Dots per inch): 400/800/1600/3200 dpi
- Регулируемая частота опроса по разъему USB: 125/500/1000 Гц
- Разъем: USB
- Количество кнопок: 7 кнопок
- Длина кабеля: 2 метра (6,6 фута)

Изменение значения DPI

Для переключения на нужное значение DPI нажмите кнопку переключения DPI (поз. )

Регулировка частоты опроса по разъему USB

Для переключения на нужное значение частоты опроса мыши нажмите кнопку переключения "Частота опроса" (поз. )

Technické údaje

- Nie je potrebný žiadny ovládač.
- Nastavenie DPI (Dots per inch): 400/800/1600/3200 dpi
- Nastaviteľná frekvencia USB: 125/500/1000 Hz
- Konektor: USB
- Tlačidlá: 7 tlačidiel
- Dĺžka kábla: 2 metrov (6,6 stôp)

Zmena nastavenia DPI

Stlačte tlačidlo prepínača DPI (označené ) , čím prepnete na požadované nastavenie DPI.

Nastavenie frekvencie USB

Stacte tlačidlo prepínača frekvencie (označené ) , čím prepnete na požadované nastavenie frekvencie.

Tehnični podatki

- Gonilnik ni potreben.
- Nastavitve DPI (Dots per inch): 400/800/1600/3200 dpi
- Prilagodljiva hitrost poročanja USB: 125/500/1000 Hz
- Priključek: USB
- Gumbi: 7 gumbov
- Dolžina kabla: 2 metra (6,6 čevlja)

Spreminjanje nastavitve DPI

Pritisnite gumb za preklop DPI (z oznako ) , da preklopite na želeno nastavitvev DPI.

Prilagajanje hitrosti poročanja USB

Pritisnite gumb za preklop hitrosti poročanja (z oznako ) , da preklopite na želeno nastavitvev hitrosti poročanja.

仕様

- ドライバは必要ありません。
- DPI (Dots per inch) 設定 : 400/800/1600/3200 dpi
- 調整可能 USB レポートレート : 125/500/1000 Hz
- 接続方式 : USB
- ボタン : 7 個のボタン
- ケーブル長 : 2 メートル (6.6 フィート)

DPI 設定の変更

DPI 切り換えボタン ( の表示) を押して、DPI 設定に切り換えます。

USB レポートレートの調整

レポートレート切り換えボタン ( の表示) を押して、レポートレート設定に切り換えます。

注意 : ここに示す図は参照用であり、実際の製品仕様とは異なる場合があります。

사양

- 드라이버가 필요 없습니다 .
- DPI (Dots per inch) 설정 : 400/800/1600/3200 dpi
- 조정 가능한 USB 보고 속도 : 125/500/1000 Hz
- 커넥터 : USB
- 버튼 : 7 개 버튼
- 케이블 길이 : 2 미터 (6.6 피트)

DPI 설정 변경

DPI 스위치 버튼 ( 가 표시된 버튼) 을 눌러 원하는 DPI 설정으로 전환합니다 .

조정 가능한 USB 보고 속도

보고 속도 전환 버튼 ( 가 표시된 버튼) 을 눌러 원하는 보고 속도 설정으로 전환합니다 .

참고 1: 여기에 나온 그림은 단지 참조용일 뿐이며 구입한 실제 제품과 다를 수 있습니다 .

참고 2: 마우스로부터 마우스 케이블을 분리하지 마시오 .

規格

- 免驅動程式。
- DPI (Dots per inch) 設定：400/800/1600/3200 dpi
- 可調 USB 回報率：125/500/1000 Hz
- 接頭：USB
- 按鍵：7 個按鍵
- 傳輸線長：2 公尺 (6.6 英呎)

變更 DPI 設定

按下 DPI 切換按鍵 (標示為 ) 切換為所需的 DPI 設定。

調整 USB 回報率

按下回報率切換按鍵 (標示為 ) 切換為所需的回報率。

警告：USB 連接線上附有一個活動夾式鐵粉芯，此鐵粉芯在連接上距 USB 接頭 7 公分處繞鐵粉芯 1 圈，此為防電磁干擾使用，請勿任意取下，避免電磁干擾。

注意 1：本文件的圖解僅供參考，外觀可能與實際產品不同。

注意 2：滑鼠本體與線材為一個產品，不可分離。

规格

- 免驱动程序。
- DPI (Dots per inch) 设置：400/800/1600/3200 dpi
- 可调 USB 回报率：125/500/1000 Hz
- 接头：USB
- 按键：7 个按键
- 传输线长：2 米 (6.6 英尺)

更改 DPI 设置

按 DPI 切换按键 (标记为 ) 可切换到所需的 DPI 设置。

可调 USB 回报率

按回报率切换按键 (标记为 ) 可切换到所需的回报率设置。

Teknik özellikler

- Sürücü gerekli değildir.
- DPI (Dots per inch) ayarları: 400/800/1600/3200 dpi
- Ayarlanabilir USB raporu oranı: 125/500/1000 Hz
- Konektör: USB
- Düğmeler: 7 düğme
- Kablo uzunluğu: 2 metre (6,6 ft)

DPI ayarını değiştirme

İstediğiniz DPI ayarına geçmek için DPI svici düğmesine ( etiketli) basın.

USB rapor oranını ayarlama

İstediğiniz rapor oranı ayarına geçmek için Rapor oranı svici düğmesine ( etiketli) basın.

المواصفات

- لا يوجد محرك أقراص مطلوب.
- إعدادات DPI (Dots per inch): 3200/1600/800/400 dpi
- معدل تقرير USB قابل للضبط: 1000/500/125 هرتز
- الموصل: USB
- الأزرار: 7 أزرار
- طول الكابل: 2 متر (6.6 قدم)

تغيير إعداد DPI

اضغط على زر تبديل DPI (يحمل اسم ) للتبديل إلى إعداد DPI المطلوب.

ضبط معدل تقرير USB قابل للضبط

اضغط على زر مفتاح معدل التقرير (يحمل اسم ) للتبديل إلى إعداد معدل تقرير مطلوب.

Taiwan RoHS 限用物質含有情況標示聲明

設備名稱：	電競滑鼠					
型號 (型式)：	S1、S2、FK1+-B、FK1-B、FK2-B、ZA11-B、ZA12-B、ZA13-B					
單元	限用物質及其化學符號					
	鉛 (Pb)	汞 (Hg)	鎘 (Cd)	六價鉻 (Cr ⁺⁶)	多溴聯苯 (PBB)	多溴二苯醚 (PBDE)
上下蓋	○	○	○	○	○	○
滾輪	○	○	○	○	○	○
鋼珠	○	○	○	○	○	○
螺絲	○	○	○	○	○	○
纜線與電源線	○	○	○	○	○	○
印刷電路板	○	○	○	○	○	○
備考 1：“○”係指該項限用物質之百分比含量未超出百分比含量基準值。 備考 2：“-”係指該項限用物質為排除項目。						

E-Waste Declaration for India



This symbol on the product or on its packaging indicates that this product must not be disposed of with your other household waste. Instead it is your responsibility to dispose of your waste equipment by handing it over to a designated collection point for the recycling of waste electrical and electronic equipment. The separate collection and recycling of your waste equipment at the time of disposal will help to conserve natural resources and ensure that it is recycled in a manner that protects human health and the environment. For more information about E-waste and the places to drop off your waste equipment for recycling in India please visit <http://www.benq.com/support/recycle>



© 2020 BenQ Corporation.
All rights reserved. Rights of modification reserved.

DN: ZAFKS-UG-V0