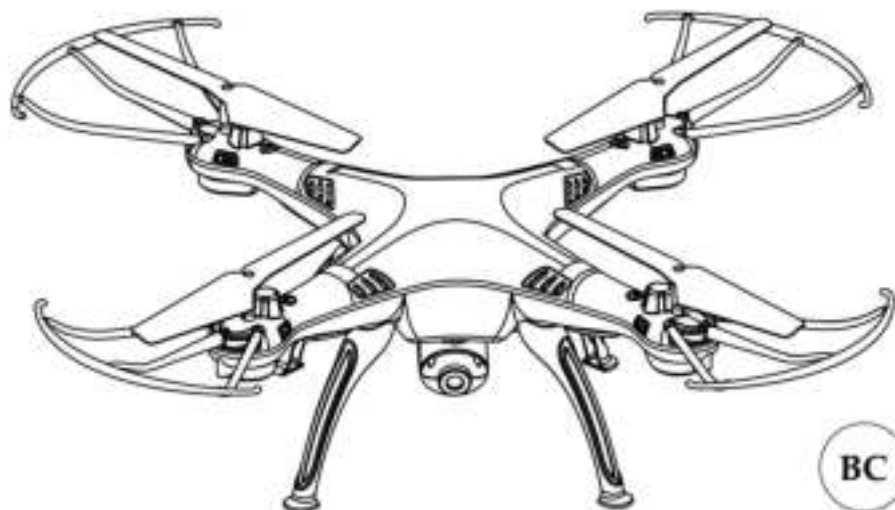

X5SW **EXPLORERS**

GYROSCOPE 24G
4CH 2.4G REMOTE CONTROL QUADCOPTER

**1****IMPLEMENT STANDARD: GB/T26701-2011**

Main characteristics

- Four-axis structure is applied, which makes the quadcopter more flexible and rapid when flying. It has the characteristics of wind-resistant and can be flown indoor or outdoor.
- Built-in 6 axis gyroscope for precise hovering in the sky.
- Modular design structure is applied, more simple for assembly and convenient for maintenance.
- With 360° 3D eversion function and throwing flight function.
- Added headless function; WIFI real-time aerial photo

The materials and specification mentioned in this instruction manual or the parts inside this package is for reference only. Our company won't be responsible for any adaption of the outer package. Nor shall we keep our customers informed in advance. Any information updates or changes, please be subject to our website.

Safety regulations

1. Please put smaller parts of the aircraft in the place where children can't reach, avoiding from accidents.
2. Power of this aircraft is adequate. Therefore, when flying for the first time, it should push remote control's right/left variable-speed joystick slowly, avoiding from collisions caused by rising aircraft rapidly.
3. After flying, it should turn off remote control's power supply and come close to the aircraft to turn off its power supply.
4. Please don't put battery in high-temperature and heated places(such as fire or nearby electric heating devices).
5. When the aircraft flies, it should maintain 2-3 meters from the user or others, avoiding from crashing into others' head, face or body when it lands.
6. When children operate the aircraft, they should be accompanied with the adult and guided by the adult. Ensure that the aircraft is controlled within the range of operator's (or instructor's) visibility. It is convenient for controlling.
7. Non-rechargeable battery can't charge. As installing or changing battery, please pay attention to the polarity. Don't use a mixture of old and new battery or battery with different types.
8. When it isn't used, it should turn off remote power supply of remote control and aircraft, respectively, and take out the battery in remote control.
9. Power supply terminal can't be short circuit.

Maintenance

1. Use clean soft cloth to clean this product frequently.
2. Avoid from exposure or heating in the sun.
3. Don't put the toy in the water. Otherwise, it'll damage electronic parts.
4. Please check the plug and other accessories at regular intervals. If there is any damage, please stop using it immediately until it is repaired completely.

Contents

Product included following contents:

- | | |
|--------------------------|----------------|
| - Quadcopter | - Screwdriver |
| - 2.4G Remote controller | - Landing gear |
| - USB charging wire | - WIFI Camera |
| - Instruction manual | - Screw |
| - Protecting frames | - Blade |
| - Phone attaching clamp | |



Get to know your transmitter

Introduction of transmitter:

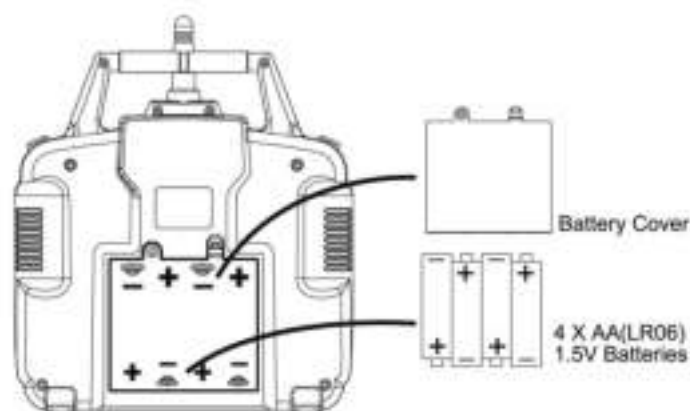
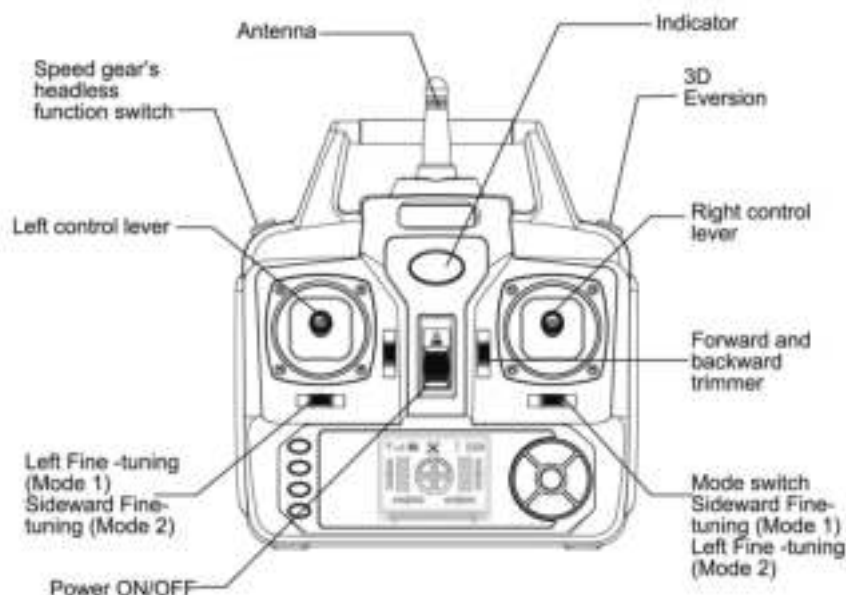

Installation methods of battery: Open back battery cover of remote control, and put 4 No.5 alkaline batteries in the middle place correctly, according to battery box's pole indication (battery should be available separately).



1. Install batteries with correct polarity.
2. Do not mix old and new batteries.
3. Do not mix different types of batteries.

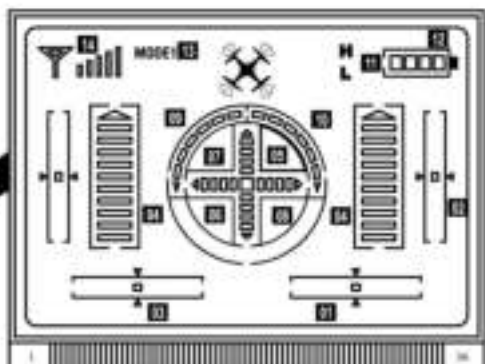
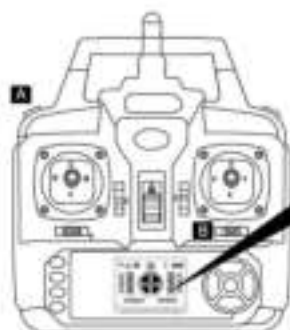

- 01.Sideward Fine-tuning :Power-on start in the centering.(Be turn Left/Right Fine-tuning in Mode2)
- 02.Forward/Backward fine-tuning:Power-on start in the middle.
- 03.Turn Left/Right fine-tuning:Power-on start in centering.(Be Sideward Fly Fine-tuning in Mode2)
- 04.Forward shows:Power-on start in the lowest level.(At the center square)
- 05.Backward shows:Power-on start in the lowest level.(At the center square)
- 06.Right sideward fly shows:Power-on start in the lowest level.(At the center square)
- 07.Left sideward fly shows:Power-on start in the lowest level.(At the center square)
- 08.Turn left: Pull left function lever to left, it will be higher, than quadcopter turn left faster.
- 09.Turn right: Pull left function lever to right, it will be higher, than quadcopter turn right faster.
- 10.High/Low speed: Press button "A" for seconds to switch between high speed mode or low speed mode. "H" means high speed and "L" means low speed.
- 11.Power shows:According to the battery's energy for the controller.
- 12.Default mode when power-on.When change to MODE 2, please keep pressing button "B" to right than return on the power of transmitter, the MODE on LCD displayer will be changed. Same steps to change to MODE 1 again.
- 13.Signal shows:Normally to full frame.

Install landing skids & blade protecting frame



Figure 1

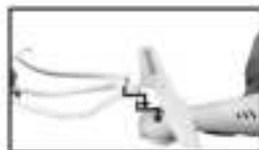

Figure 2



Figure 3

1. Insert foot stands into interface of lower main body as shown in Figure (1).
2. Install the blade protecting frame to every corner than lock screws Figure (2-3).

Component installation of WIFI real-time aerial photo

Installation of phone attaching clamp



Figure 1



Figure 2



Figure 3

1. Insert phone attaching clamp by aiming at antenna on remote control. (1)
2. Press spring of attaching clamp forcibly to resize. (2)
3. Hold phone attaching clamp and pull out forcibly to disassemble phone attaching clamp. (3)

WIFI software download and installation

Install software

For Android phone, please download from www.symatoys.com or scan two-dimension code to install SYMA FPV software.

For iPhone IOS, please download from APP STORE to install SYMA FPV software or scan two-dimension code to install SYMA FPV software.

Warm remind: Two-dimension code is provided in color box packing and back cover of specification to scan.

2. Connection Description

When connecting with model power, indicator light of FPV is green light. Red light flashes slowly after 20 seconds for waiting to connect with the phone. Click "setting" of the phone, open WIFI, find out "FPV WIFI *****" in WIFI searching list, click connection until it appears "connected", indicating successful connection, and now exit setting option. Open SYMA FPV software, click "START" button and enter into control interface. Image is showing on phone screen. WIFI signal is full, showing the strongest signal right now.



1. Open the software SYMA FPV.



2. Click the "START" button.



3. Image is showing on the screen.

3. Icon description of real-time interface

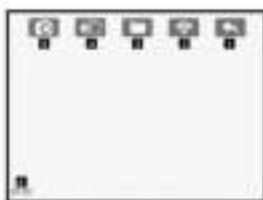

1. Return
2. WIFI signal
3. Phone and video check
4. Video
5. Photograph
6. Time display

4. Real-time aerial photo

Photo & video: When WIFI camera stays in normal state, click photo or video icon on the real-time interface to take pictures or video (files of photo or video can be checked in the folder of "photo and video check".)

Controller modes & instructions

The transmitter built-in two modes, Mode 1 & Mode 2, in line with different customer's usage pattern. Keep pushing button B to right, then turn on the transmitter power to change Mode 1 or Mode 2.



MODE 1

Operating direction

Hover up and down

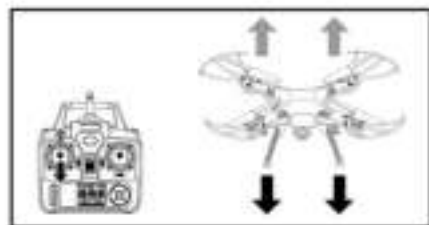

Push the throttle up or down, the quadcopter flies upward or downward.

Forward and backward

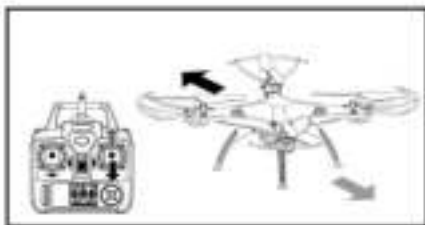

Push the direction lever up or down, the quadcopter flies forward or backward.

Turn Left and Right

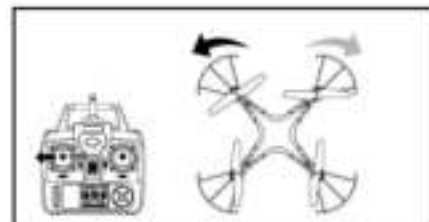

Pull the throttle left or right, the quadcopter turns to left or right.

Sideward fly

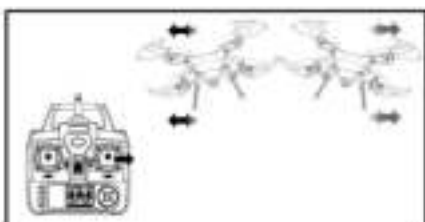

Pull the direction lever left or right, the quadcopter flies to left side or right side.

Fine-tuning operation

Forward/Backward fine-tuning



When the quadcopter keeps flying forward / backward, you can correct it by pressing fine-tuning button down / up.

Sideward Fly fine-tuning



When the quadcopter keeps flying to left / right side, you can correct it by pressing the Fine-tuning button right / left.

Turn left/right fine-tuning

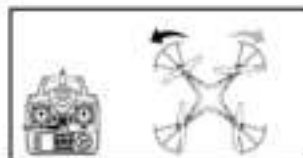

When the quadcopter keeps rotating to left / right, you can correct it by pressing the fine-tuning button right / left.

MODE 2

Operating direction

Hover up and down

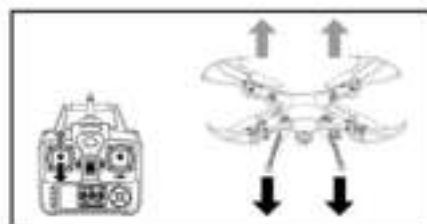

Push the throttle up or down, the quadcopter flies upward or downward.

Forward and backward

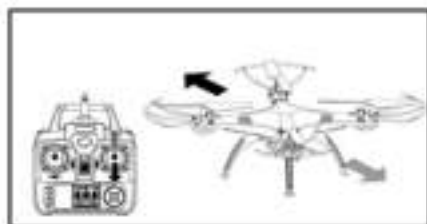

Push the direction lever up or down, the quadcopter flies forward or backward.

Turn Left and Right

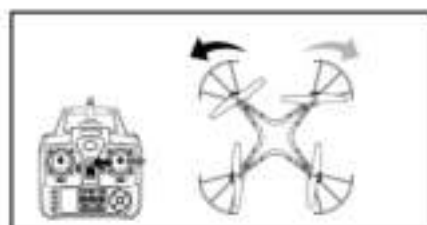

Pull the direction lever left or right, the quadcopter turns to left or right.

Sideward fly

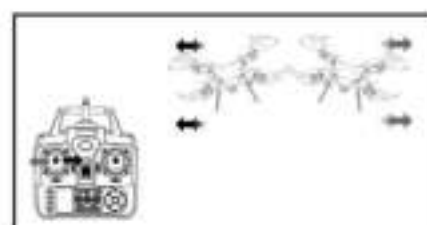

Pull the throttle left or right, the quadcopter flies to left side or right side.

Fine-tuning operation

Forward/backward fine-tuning



When the quadcopter keeps flying forward / backward, you can correct it by pressing fine-tuning button down / up.

Sideward fly fine-tuning

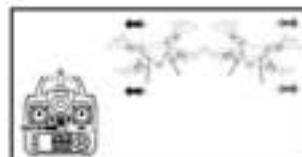

When the quadcopter keeps flying to left / right side, you can correct it by pressing the Fine-tuning button right / left.

Turn left/right fine-tuning

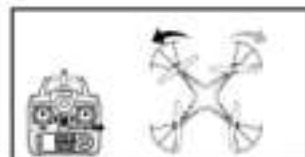

When the quadcopter keeps rotating to left / right, you can correct it by pressing the fine-tuning button right / left.

Ready to fly your quadcopter



1. Press the ON/OFF power switch up.



2. Open battery cover, and connect battery connector with dash receiver.



3. Enclose battery into the fuselage, after closing battery cover, turn on the switch on the bottom of aircraft.



4. Push the throttle lever to the highest position, and then pull it back to the lowest position. There will be one clear sound from the transmitter, this shows that the quadcopter has entered into the pre-fly state.

Function introduction

1. Low-voltage protection:

When four indicator lights on the bottom of aircraft start to flicker, it means electric quantity of the aircraft is insufficient. Please control the aircraft to make a return voyage.



2. Over-current protection:

In the condition of rotating aircraft's fan blade, when being crashed or stuck, aircraft's circuit will conduct over-current protection.

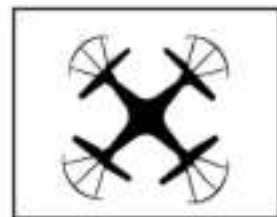

3.Horizontal correcting function:

Place the quadcopter on a horizontal position, then push transmitter both left and right lever to lowest right corner for about 2-3 second, indicator on the quadcopter changed from normal lights up to quickly flashing; After 2-3 second, the indicator changed to normal lights, it means the quadcopter restarted /reset successfully.

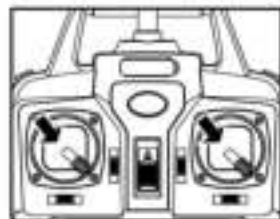

4.3D eversion:

When you are familiar with the basic operation, you can do some awesome & exciting tricks and stunts! First of all, fly the aircraft to a height of more than 3 meters, press the 3D Eversion switch on the rear right side of the transmitter, then push the right rudder (in any direction) to make 360 degree flip.

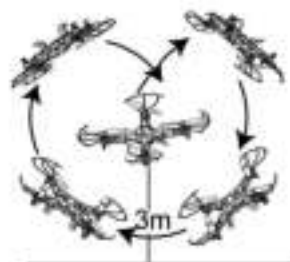

Tips: 3D eversion goes better when battery power is enough.

5.Throwing flight instructions:

Thanks to the 6 axis gyroscope, you can throw the quadcopter and push the throttle right up, it will automatically level out and hover smoothly in the sky. This can also be done when the quadcopter is rolling.



6.Headless function:

1. Forward definition

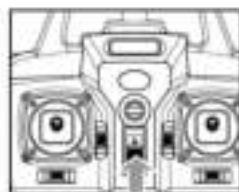

1. Turn on power switch of remote control.



2. After aircraft connects with power supply, place the switch in "ON" position, adjust the direction pointed by aircraft's handpiece and regard it as the dead ahead in headless situation.

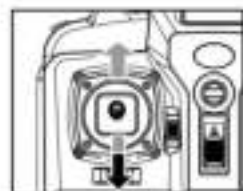

3. Push the accelerator's push rod of remote control to the highest point and pull back to the lowest point. When remote control pops, it indicates that frequency modulation and forward definition have already finished.

2. Switch to headless function and general function

1. After frequency modulation, the aircraft defaults to general pattern. The indicator light on aircraft is long bright state. After pressing down headless function switch on the top left of master remote controller for 2 seconds, remote control will give out "DDD...", it means that it enters into headless state. After pressing for 2 seconds and hearing long "D", it means that it exits headless state. (In headless mode, four indicators on the aircraft flicker slowly for once within four seconds)

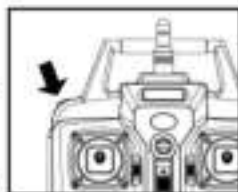

2. In headless state, the operator has no need to recognize the position of aircraft's headpiece, and he just needs to control the aircraft in accordance with the direction of remote control's operating rod.



3. Correcting forward direction

1. After aircraft crashes in headless state, if there is deviation in head direction, it just needs to adjust the aircraft's direction again, pull remote control's accelerator and operating rod to bottom left simultaneously. When indicator light on the aircraft flickers for slow three seconds, it means that correction is done.

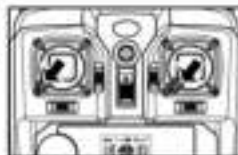

Change battery of quadcopter

1. Push the on/off switch of quadcopter to OFF position than open the battery cover.



2. Pull out the battery wire from the power port.



3. To charge battery, please insert the USB port of provided USB charging cable to anyone USB port of computer.

The indicator on USB cable will light ON during charging battery, than it will light OFF when battery fully charged.



Caution:

When using the computer for charging, please remember to pull out the charging cable before shutting down the computer. Take the battery cover, and close the battery cover on the quadcopter.

4. Reconnect the battery wire to power port than close the battery cover.



Charging time: about 130 minutes — Flying time: about 5.5 minutes!

Cautions when charging:

1. When charging, please put this product on a dried or ventilated area and keep it far away from heat source or explosive product.
2. When charging, please remove the batteries from the quadcopter. Then charging process should be supervised by an adult so as not to cause an accident.
3. When finish flying, please do not charge the battery if the surface temperature is still not cool. Otherwise it may cause a swollen battery or even a fire hazard.
4. Please make sure that you use the original USB charging cable provided. When the battery has been used for a long time, or appears to be swollen, please replace them.
5. A battery when not in use for a long time will lose its charge automatically. Charging or discharging too often may reduce the life of the battery.

WiFi install camera

Disassembly steps of camera:

1. Pull out power supply cable of the camera as shown in Figure (1).
2. Press safe lock of lower main body forcibly and pull back the camera simultaneously.



Figure 1



Figure 2

Installation steps of camera:

1. Push the camera in place as shown in Figure (1).
2. Connect connecting line of camera with power supply socket of fuselage's camera as shown in Figure (2).



Figure 1



Figure 2

Maintenance procedure

Problems	Causes	Solutions
Aircraft has no response	<ol style="list-style-type: none">1. Aircraft enters into low-voltage protection.2. Electric quantity of remote control is insufficient, power indicator light will flicker.3. Channel selection of remote control is inconsistent with aircraft's match codes.	<ol style="list-style-type: none">1. Charge the aircraft.2. Change remote control's battery.3. Adjust channels of remote control and aircraft, and make them become consistent.
Aircraft's flying response is insensitive	<ol style="list-style-type: none">1. Insufficient remote control's electric quantity.2. Remote control with the same frequency is transmitting interference.	<ol style="list-style-type: none">1. Battery replacement.2. Change the place where has no transmitting interference of the same frequency.
When hovering, side flight is formed	<ol style="list-style-type: none">1. Have no horizontal correction.	<ol style="list-style-type: none">1. Conduct horizontal correction, as shown in p.9(3)(correcting function)
In headless state, it deviates to dead ahead	<ol style="list-style-type: none">1. Head deflection is caused by multiple collisions.	<ol style="list-style-type: none">1. Define forward again, as shown in p.9-10(6)(headless function)

Spare parts

Here are alternative accessories. In order to provide convenience for customer purchasing, every component are marked. Accessories can be purchased from local dealer. Please specify the color when purchasing.



X5SW-01A
Fuselage (white)

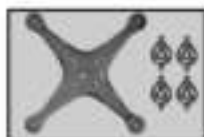

X5SW-01B
Fuselage (black)



X5SW-02A
Rotating blade (white/black)



X5SW-02B
Reversing blade (white/black)



X5SW-03A
Landing skids (white)



X5SW-03B
Landing skids (white)



X5SW-04
Protecting frames



X5SW-05
Lampshades



X5SW-06A
Motor A



X5SW-06B
Motor B



X5SW-07
Light boards



X5SW-08
Receiver board



X5SW-09
Battery



X5SW-10
USB



X5SW-11
Camera (white)



X5SW-12
Camera (black)



X5SW-13
Transmitter



X5SW-14
Phone attaching clamp

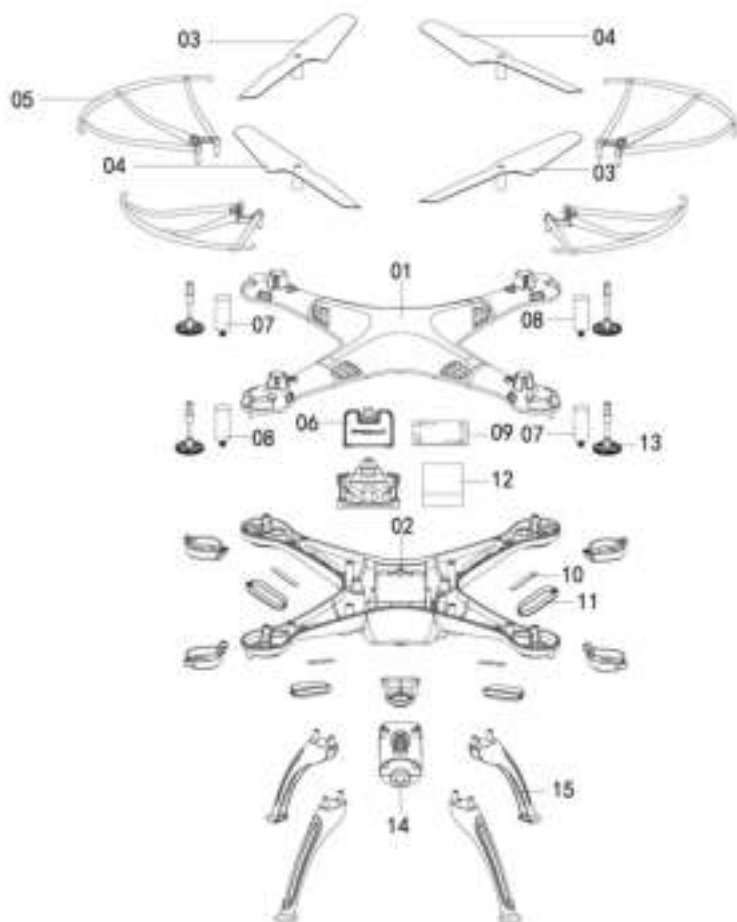

Code	Description	Quantity	Code	Description	Quantity	Code	Description	Quantity
01	Upper body	1	07	Rotating motor	2	13	Gear	4
02	Lower body	1	08	Reversing motor	2	14	WiFi camera	1
03	Rotating blade	2	09	Circuit board	1	15	Landing skids	4
04	Reversing blade	2	10	Lampshades	4			
05	Protecting frames	4	11	Light boards	4			
06	Battery cover	1	12	Battery	1			

Main parameter

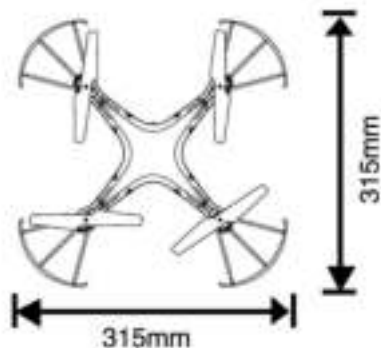
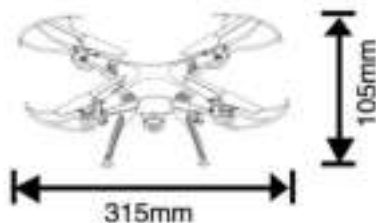

Length of fuselage:315mm

Width of fuselage:315mm

Code of main engine: Ø8

Height of fuselage:105mm

Battery:3.7V 500mAh



SPECIFICATIONS AND COLORS OF CONTENTS MAY VARY FROM PHOTO.



Two-dimension code
of Android system



Two-dimension code
of iPhone iOS system

The company has the right of final interpretation
of this instruction manual statement.