

little tikes

littletikes.com

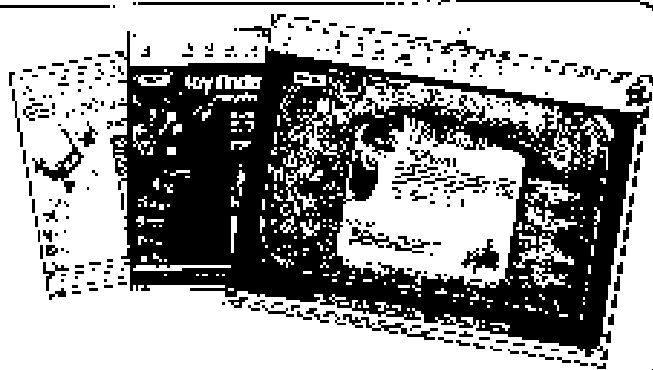

- Catalogue des produits
- Nouveaux jouets
- Service clientèle
- Pièces de rechange
- Casques antibruit
- Remplacement de b.
- Catalogue de modèles
- Jouets neuves
- Service clientèle
- Pièces de rechange
- Boutons
- Travaux de montage
- Produits en vente
- Nouveaux
- Service clientèle
- Casques antibruit
- Remplacement de b.
- Casques antibruit

426110060

R034263-S1/3-4/05

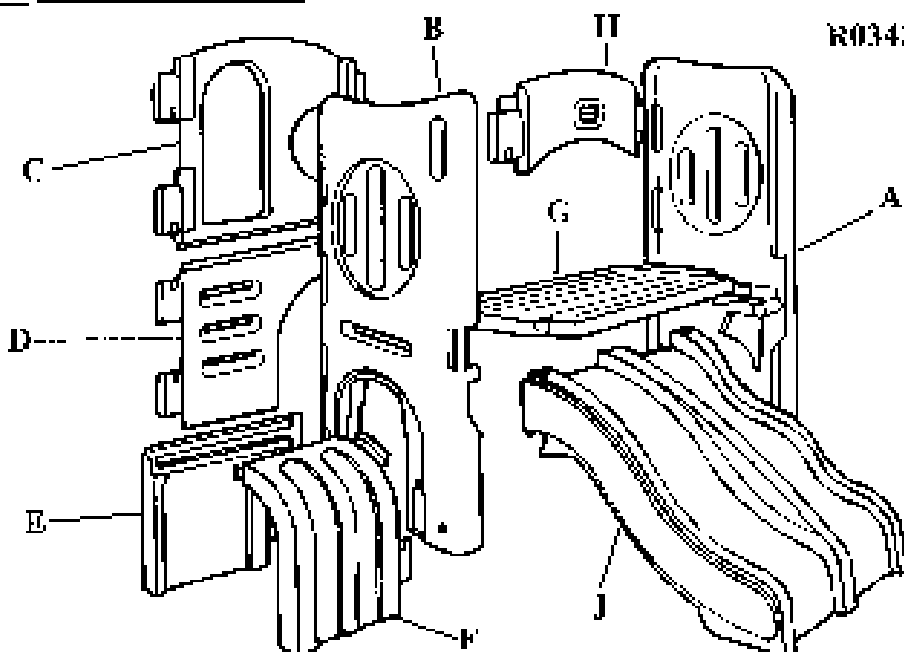
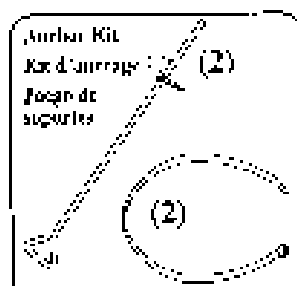

ENGLISH

TWIN SLIDE TUNNEL CLIMBER

ages 2 - 6 years

Please see sides page for rest of product.

ADULT ASSEMBLY REQUIRED.

WARNING:

- Keep away from car for fire risk factors.
- This assembly has many small parts, hardware which are choking hazard and may contain sharp points. Keep away from children until assembled.
- Fall from hard surfaces would result in head or neck injuries. Never play on hard concrete, asphalt, rock, packed earth or other hard surfaces. Carpet over level areas. Use soft ground in any change out points. Use softening of the ground under or around the playground equipment according to the company "Company Information Sheet on: Playground Surfacing Materials" Manual. Full height restriction up to 5 feet (150 cm) required.
- Adult supervision required. Do not use children unattended.
- This product is not intended for use by children ages 2 or less.
- Maximum weight per child: 60 lbs (27 kg) limit 3 children.
- Needs water for use at all times.
- This product is intended to be used indoors or in a fully enclosed area.
- After assembly, make sure all parts are "locked" securely in place.

CAUTION:

- Observe the following safety instructions and warnings on the back of each and every part.
- Place this product on a level ground. Do not use any flammable object. Do not use any flammable liquid, but are not intended for use in garages, garages, covered porches, fire pits, fire pits, etc.
- It is recommended for this product to be assembled in a shaded area for direct sunlight is minimal or no direct sunlight is recommended.
- Instructions on page use of this product only when properly placed, and follow instructions for use of this product. This product is not intended to be used without shade.
- Do not allow children to climb on parts of other products.
- Injuries will occur if users climb on the product. For a complete safety manual for use with the product, such as, but not

limited to, jump mats, slide lines, platforms, valves and chairs, as they may cause strangulation hazards.

- Do not allow children to play with loose fitting parts, such as wooden screws, or other parts that could become loose using this equipment.

ASSEMBLY:

A WARNING:

Failure to follow these warnings could result in serious injury.

- Inspect product regularly for wear or loose hardware. Remove hardware if any abnormal conditions such as cracks or breaks are detected. Do a general periodic check and make the required parts immediately replaced.
- Anchors must be installed level.
- Anchors must be installed directly below ground level in previous children's play area.
- Dig hole and install anchors can be placed directly underneath another hole in the product as shown.
- Keep slide in the upright position in location shown in step 13.
- Check cables for fraying or damage.
- Drill in all holes with drill and make sure anchors are completely covered.

MAINTENANCE:

- Check all nuts, bolts, washers, and anchor bolts monthly during usage period and tighten as required. Also check before using. If the anchor bolts are in place. Replace when necessary. If the product is used outdoors, it is procedure as followed at the beginning of each season.
- Take this product under no doing, or make it water temperatures 50 below 60°F-100°F.

DISPOSAL:

- Dispose of this equipment in a responsible manner that will not harm the environment. Do not use in small parks and playgrounds, and at the time of disposal is discarded.

CONSUMER SERVICE:

www.littletikes.com

TOLL-FREE NUMBER:

1-800-221-0180

Little Tikes
The Little Tikes Company
PO Box 2275
1300 So. My Road
Ludon, Ohio 43044-0275

Little Tikes
The Little Tikes Company
200 Eastern Drive, East Windsor
Northampton, MA 01060, USA
Tel: 410-805-2538
Monday - Friday 05:30 - 17:00
Fax: 410-805-1040

LIMITED WARRANTY

The Little Tikes Company warrants that, against defects, we warrant the product for one year from the date of purchase. This warranty is limited to the product as shown in the original packaging. This warranty does not cover any damage caused by misuse, abuse, or neglect. This warranty is void if the product is altered, modified, or damaged in any way. This warranty is void if the product is used in any way not intended by the manufacturer. This warranty does not cover any damage caused by misuse, abuse, or neglect. This warranty is void if the product is altered, modified, or damaged in any way. This warranty is void if the product is used in any way not intended by the manufacturer. This warranty does not cover any damage caused by misuse, abuse, or neglect. This warranty is void if the product is altered, modified, or damaged in any way. This warranty is void if the product is used in any way not intended by the manufacturer.

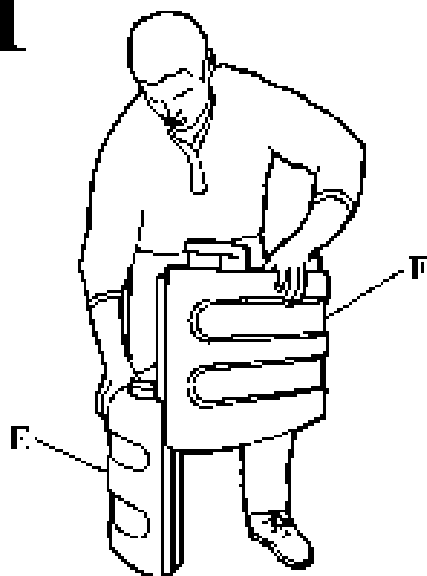
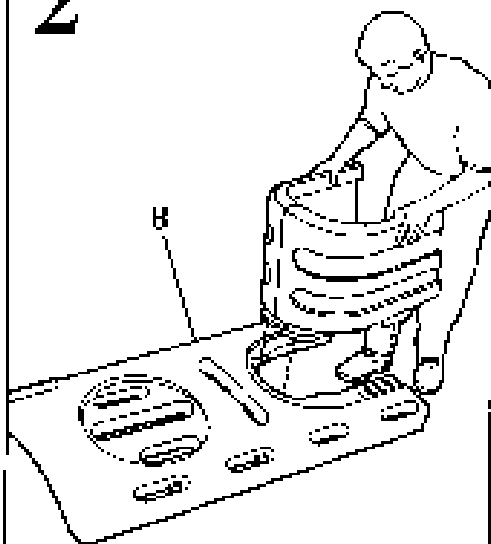
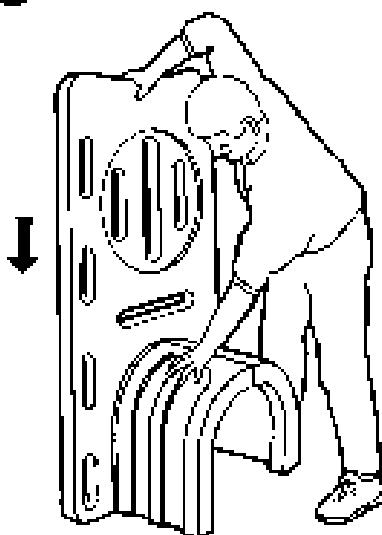
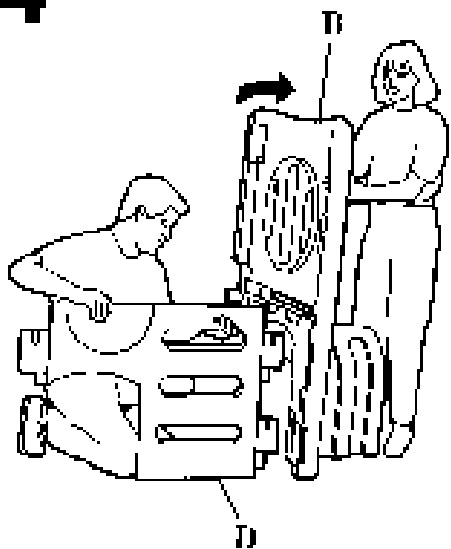
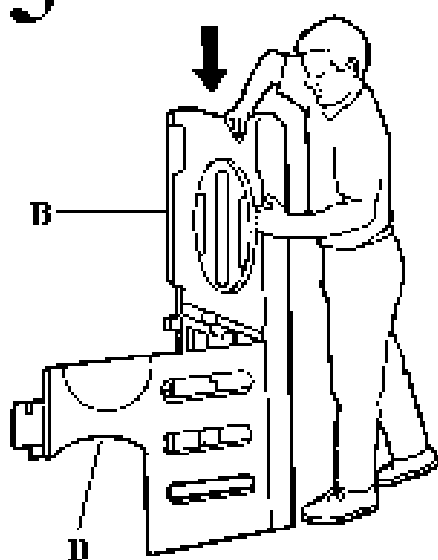
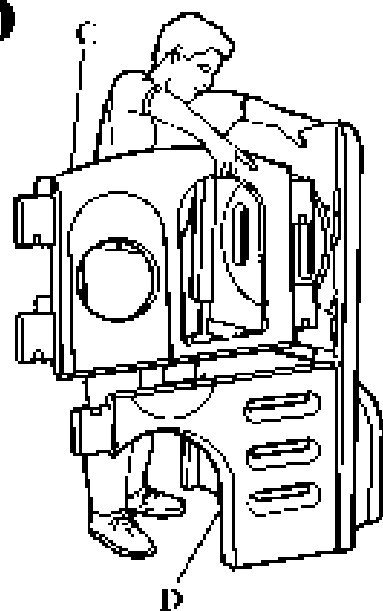
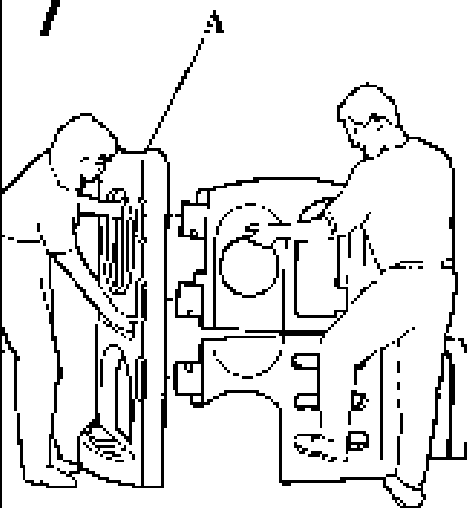
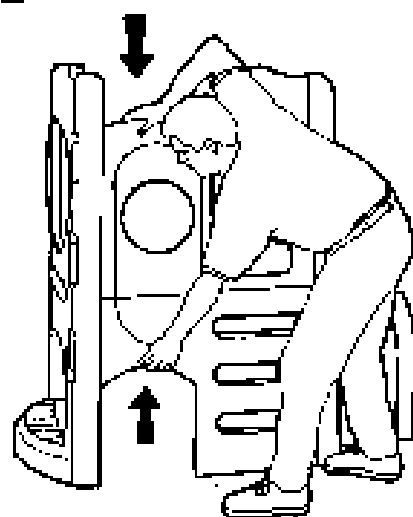
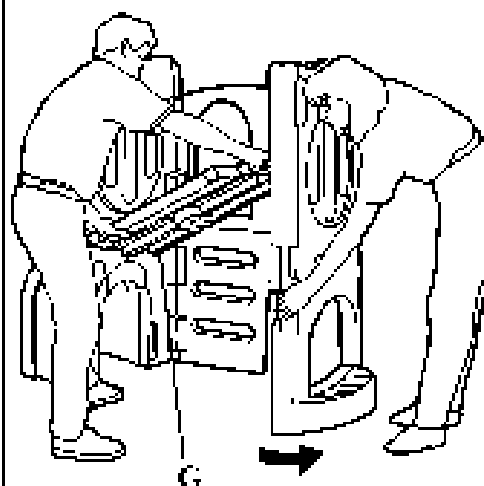

1**2****3****4****5****6****7****8****9**

13

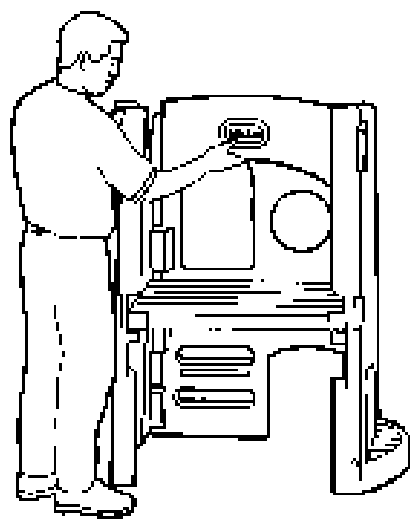

14

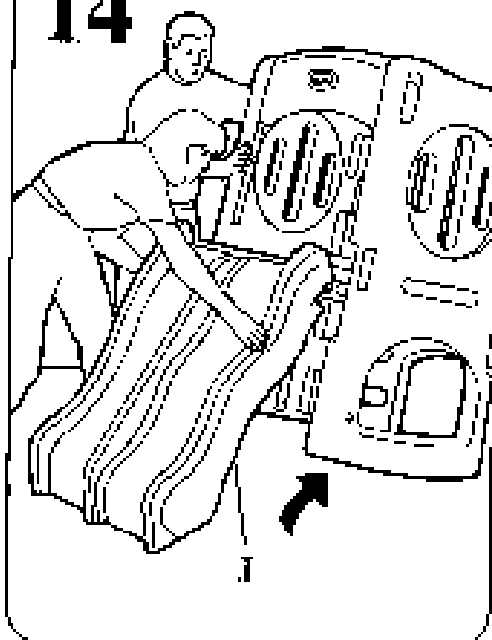

15

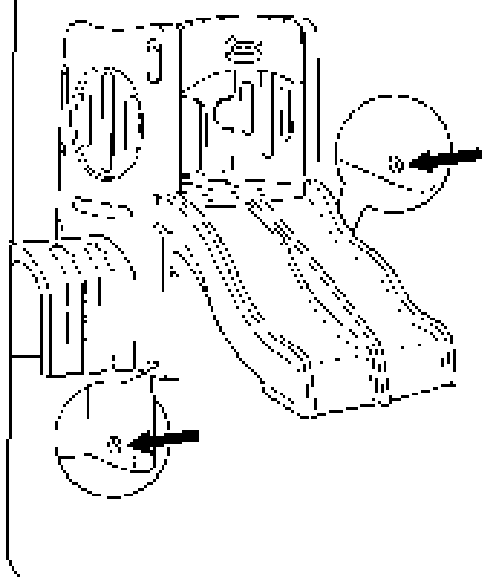

ADVERTENCIA:

- Grande capacidade não permite cargas pesadas.
- Antes de usar o lavar, leia atentamente o manual que se encontra no interior da máquina e o manual de segurança que se encontra no exterior da máquina. Não se esqueça de ler atentamente o manual de segurança da máquina.
- As lavagens devem ser feitas com a máquina fechada e com a porta da máquina fechada. Não se esqueça de ler atentamente o manual de segurança da máquina.
- Se a máquina for utilizada para lavar roupa, não se esqueça de ler atentamente o manual de segurança da máquina.
- Se a máquina for utilizada para lavar roupa, não se esqueça de ler atentamente o manual de segurança da máquina.
- Se a máquina for utilizada para lavar roupa, não se esqueça de ler atentamente o manual de segurança da máquina.
- Se a máquina for utilizada para lavar roupa, não se esqueça de ler atentamente o manual de segurança da máquina.

1. Não se utilize para lavar roupa pesada ou roupa que se machuque com facilidade.
2. Não se utilize para lavar roupa que se machuque com facilidade.
3. Não se utilize para lavar roupa que se machuque com facilidade.
4. Não se utilize para lavar roupa que se machuque com facilidade.

MANTENIMENTO:

- 1. Realizar o trabalho de limpeza, manutenção e reparação da máquina de acordo com o manual de segurança que se encontra no interior da máquina.
- 2. Realizar o trabalho de limpeza, manutenção e reparação da máquina de acordo com o manual de segurança que se encontra no interior da máquina.
- 3. Realizar o trabalho de limpeza, manutenção e reparação da máquina de acordo com o manual de segurança que se encontra no interior da máquina.

DESIGNO:

- 1. Designo e descreção do equipamento de acordo com o manual de segurança que se encontra no interior da máquina.
- 2. Designo e descreção do equipamento de acordo com o manual de segurança que se encontra no interior da máquina.

SERVICIO AL CLIENTE:

www.littleblack.com
 Little Black
 Rua da Liberdade
 1100-012 Lisboa
 Portugal
 Tel: +351 21 851 46 00
 Fax: +351 21 851 46 01
 littleblack.com



GARANTIA:

Garantia de 2 anos para a máquina de lavar roupa. A garantia é válida para a máquina de lavar roupa de acordo com o manual de segurança que se encontra no interior da máquina. A garantia é válida para a máquina de lavar roupa de acordo com o manual de segurança que se encontra no interior da máquina. A garantia é válida para a máquina de lavar roupa de acordo com o manual de segurança que se encontra no interior da máquina.

ZUSAMMENBAU DURCH ERWACHSENE. ERFOLGSDIENLICH.

WICHTIG:

- 1. Lesen Sie das Handbuch für das richtige Zusammenbauen.
- 2. Lesen Sie das Handbuch für das richtige Zusammenbauen.
- 3. Lesen Sie das Handbuch für das richtige Zusammenbauen.
- 4. Lesen Sie das Handbuch für das richtige Zusammenbauen.
- 5. Lesen Sie das Handbuch für das richtige Zusammenbauen.
- 6. Lesen Sie das Handbuch für das richtige Zusammenbauen.
- 7. Lesen Sie das Handbuch für das richtige Zusammenbauen.
- 8. Lesen Sie das Handbuch für das richtige Zusammenbauen.
- 9. Lesen Sie das Handbuch für das richtige Zusammenbauen.
- 10. Lesen Sie das Handbuch für das richtige Zusammenbauen.

ACHTUNG:

- 1. Das Zusammenbauen der Maschine ist nur für Erwachsene geeignet.
- 2. Das Zusammenbauen der Maschine ist nur für Erwachsene geeignet.
- 3. Das Zusammenbauen der Maschine ist nur für Erwachsene geeignet.
- 4. Das Zusammenbauen der Maschine ist nur für Erwachsene geeignet.
- 5. Das Zusammenbauen der Maschine ist nur für Erwachsene geeignet.
- 6. Das Zusammenbauen der Maschine ist nur für Erwachsene geeignet.
- 7. Das Zusammenbauen der Maschine ist nur für Erwachsene geeignet.
- 8. Das Zusammenbauen der Maschine ist nur für Erwachsene geeignet.
- 9. Das Zusammenbauen der Maschine ist nur für Erwachsene geeignet.
- 10. Das Zusammenbauen der Maschine ist nur für Erwachsene geeignet.

VERANKERUNGSSET

ACHTUNG:

- 1. Das Verankerungsset ist nur für Erwachsene geeignet.
- 2. Das Verankerungsset ist nur für Erwachsene geeignet.
- 3. Das Verankerungsset ist nur für Erwachsene geeignet.
- 4. Das Verankerungsset ist nur für Erwachsene geeignet.
- 5. Das Verankerungsset ist nur für Erwachsene geeignet.
- 6. Das Verankerungsset ist nur für Erwachsene geeignet.
- 7. Das Verankerungsset ist nur für Erwachsene geeignet.
- 8. Das Verankerungsset ist nur für Erwachsene geeignet.
- 9. Das Verankerungsset ist nur für Erwachsene geeignet.
- 10. Das Verankerungsset ist nur für Erwachsene geeignet.

DEUTSCH

**TUNNEL-KLETTERTURM MIT
 DOPPEL-REIFENSCHAHN**
 Alter: 2-10 Jahre
 Höhe des Kleckerturms: 80 cm
 Höhe des Kleckerturms: 80 cm