

Thank you for choosing the MG NEO-Micro chassis. Take your time reading this manual before installing your system.

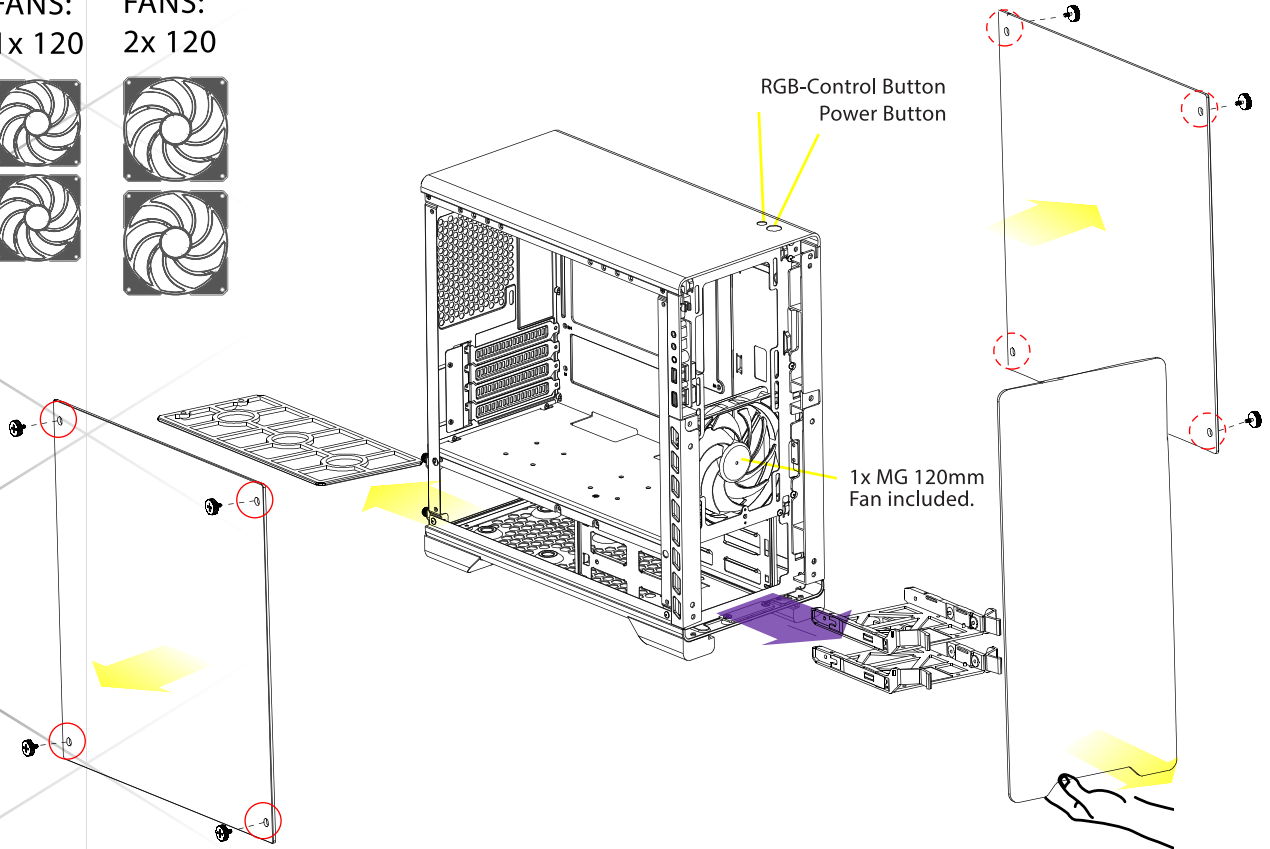

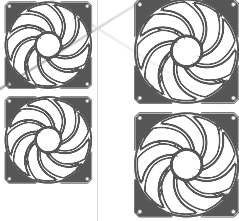



Check www.metallicgear.com for the latest information and manual version.

REAR
FANS:
1x 120

FRONT
FANS:
2x 120



ACCESSORIES

-  16x Motherboard M3 screws
-  4x PSU 6-32 screws
-  8x Fans screws
-  1x Motherboard M4 stand-off
-  2x Long Thumb 6-32 screws
-  6x Zip ties
- 1x 8-pin CPU extension 40cm

CLEARANCES

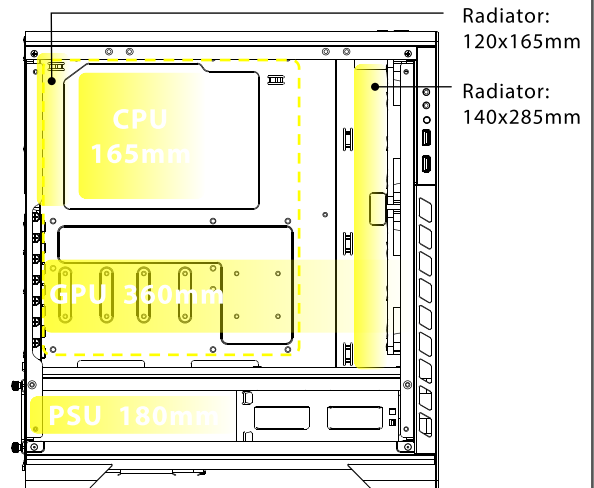

HARDWARE INSTALLATION

MOTHERBOARD

8x 

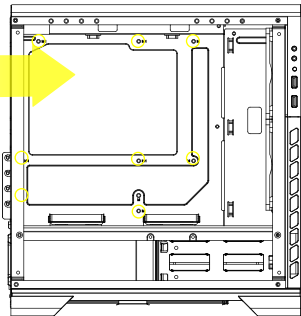
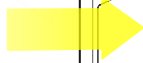
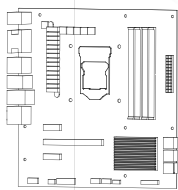

Supports:
m-ATX, ITX

POWER SUPPLY

4x 

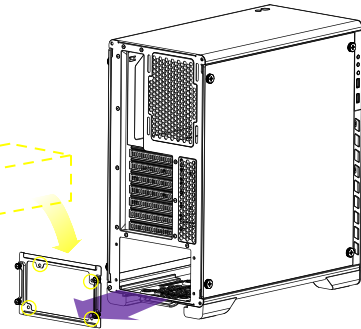

SSD

4x 

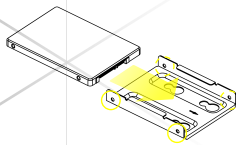

2x SSD brackets are included.

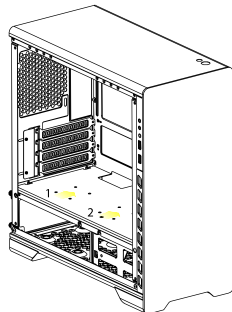

HDD

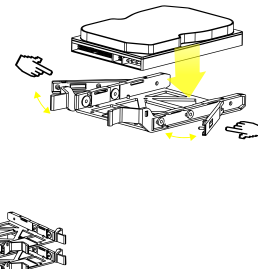
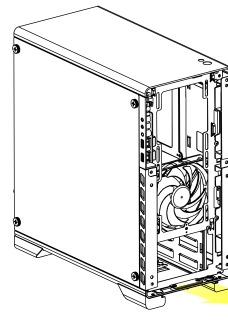

CABLE MANAGEMENT

Use the included CPU extension cable.

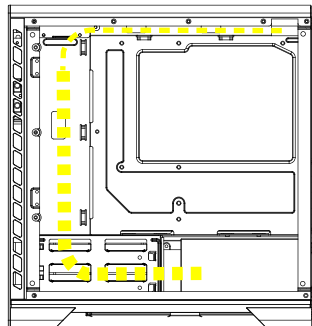

FRONT I/O CABLES

Connect to
Motherboard

Connect to
Power Supply

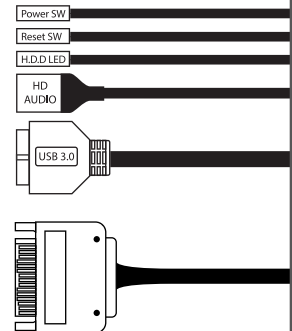

RGB-LIGHTING CONTROLS

RGB CABLES

Daisy-chain RGB Products



To Motherboard RGB Header



RGB CONTROL

- **Short Press** to change color:



- **Long Press** to change mode:

-  Solid
-  Breathing
-  Color Cycle

- **Press and Hold** to turn off or switch to motherboard control.

