

# Klipsch

## ProMedia 2.1

 Bluetooth

Owner's Manual



# SPEAKER PLACEMENT

PLACEMENT DES ENCEINTES COLOCACIÓN DE LOS ALTAVOCES LAUTSPRECHERPLATZIERUNG POSICIONAMENTO DAS CAIXAS ACÚSTICAS COLLOCAZIONE DEGLI ALTOPARLANTI 扬声器放置

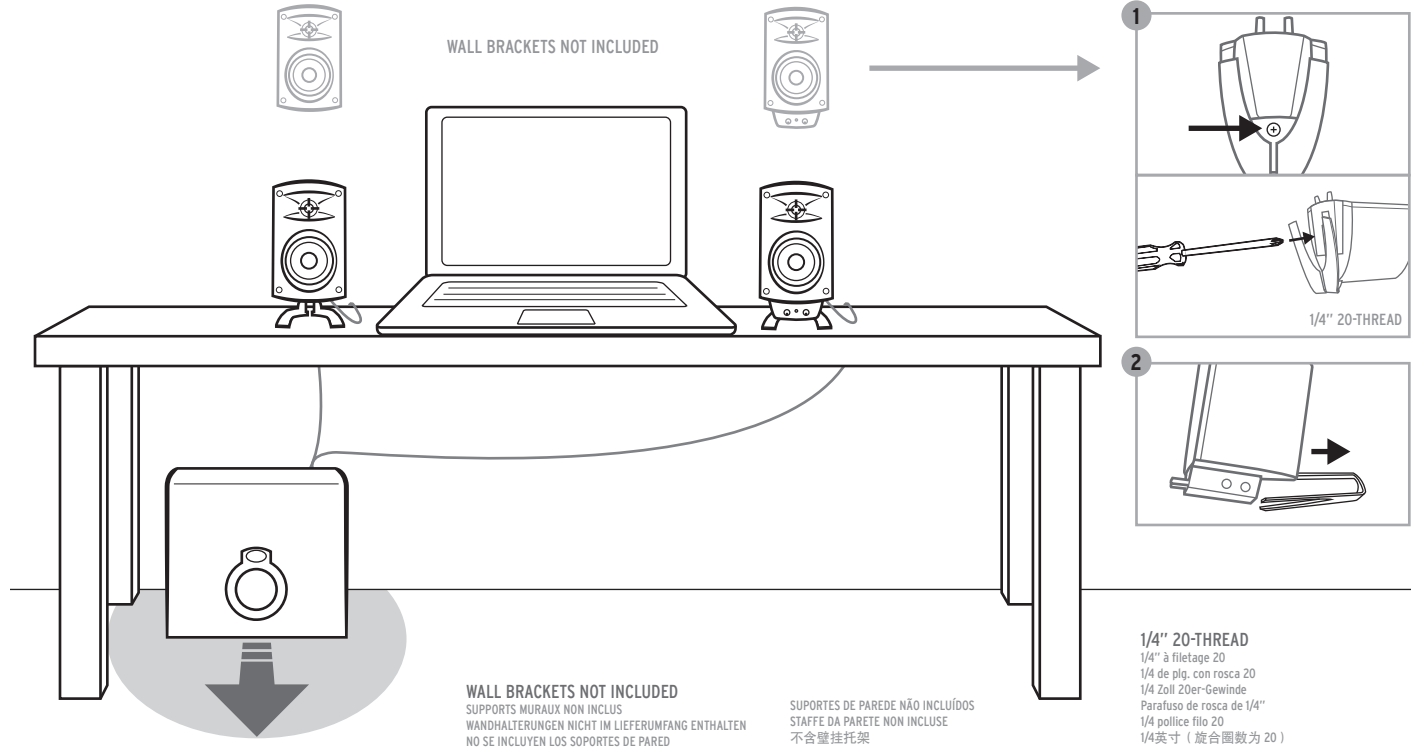

# SPEAKER CONNECTION

RACCOMENDAMENT DES ENCEINTES CONEXIÓN DE ALTAVOCES LAUTSPRECHERANSCHLUSSDIAGRAMM CONEXÃO DAS CAIXAS ACÚSTICAS COLLEGAMENTO DEGLI ALTOPARLANTI 扬声器连接图解

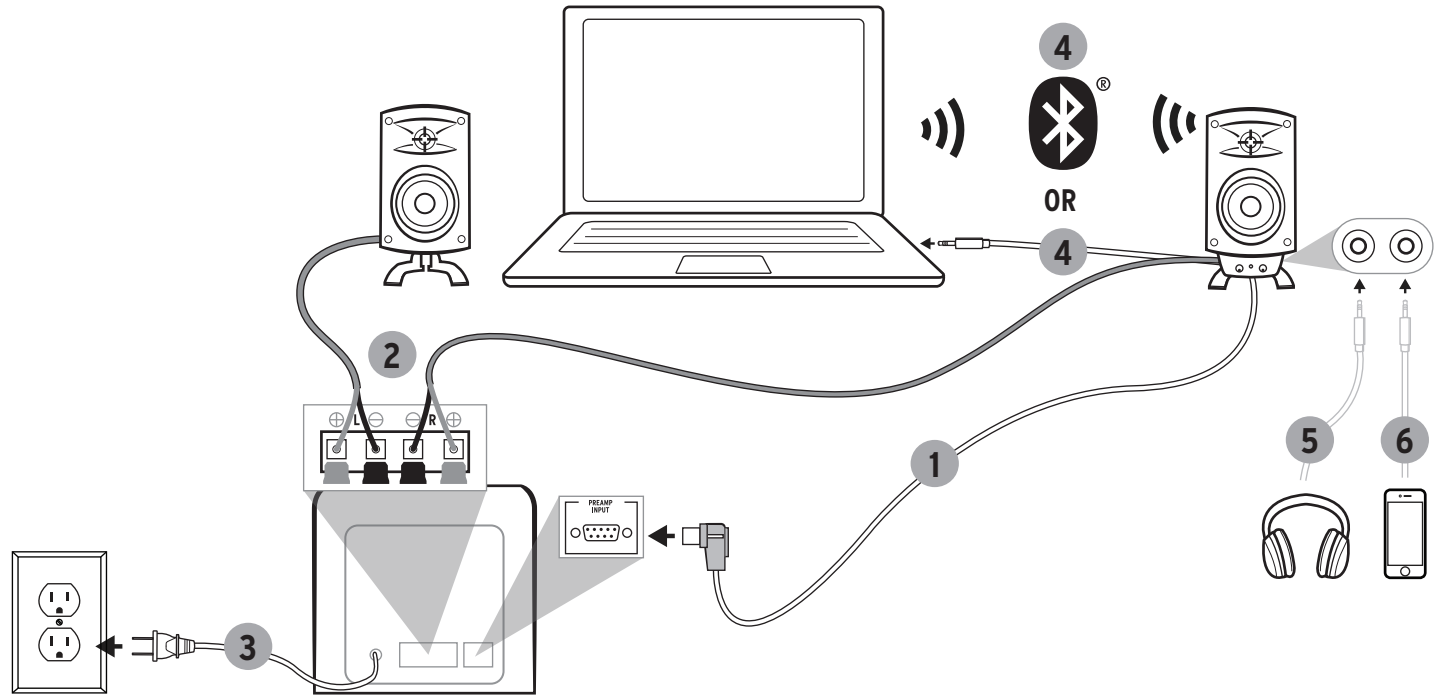

# BLUETOOTH® WIRELESS TECHNOLOGY

TECNOLOGÍA INALÁMBRICA *BLUETOOTH*® CONFIGURACIÓN DE TECNOLOGÍA WIRELESS *BLUETOOTH*® DRAHTLOSE *BLUETOOTH*®-TECHNOLOGIE-SETUP CONFIGURAZIONE TECNOLOGIA WIRELESS *BLUETOOTH*®  
CONFIGURAÇÃO DE TECNOLOGIA SEM FIO *BLUETOOTH*® *BLUETOOTH*® 蓝牙无线电技术

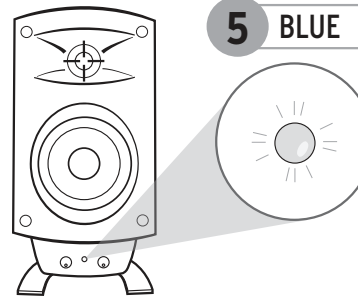
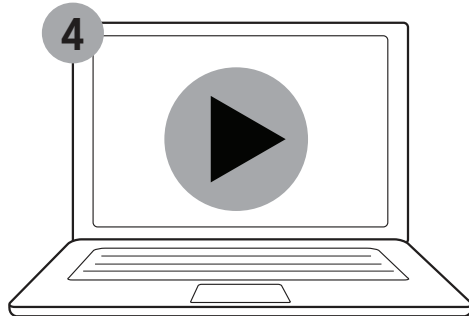
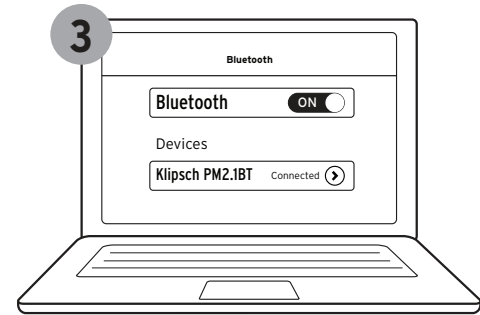
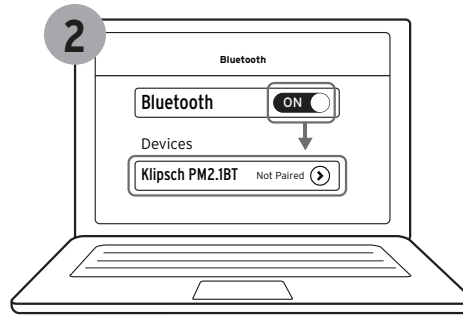
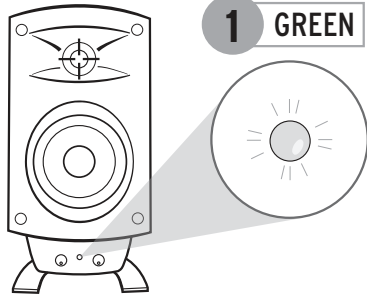

GREEN	BLUE
VERT	BLEU
VERDE	AZUL
GRÜN	BLAU
VERDE	BLU
VERDE	AZUL
绿	蓝色

# VOLUME

VOLUMEN 量

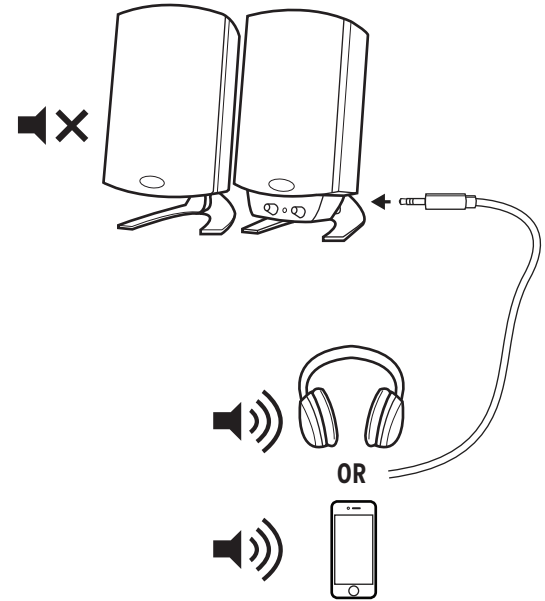
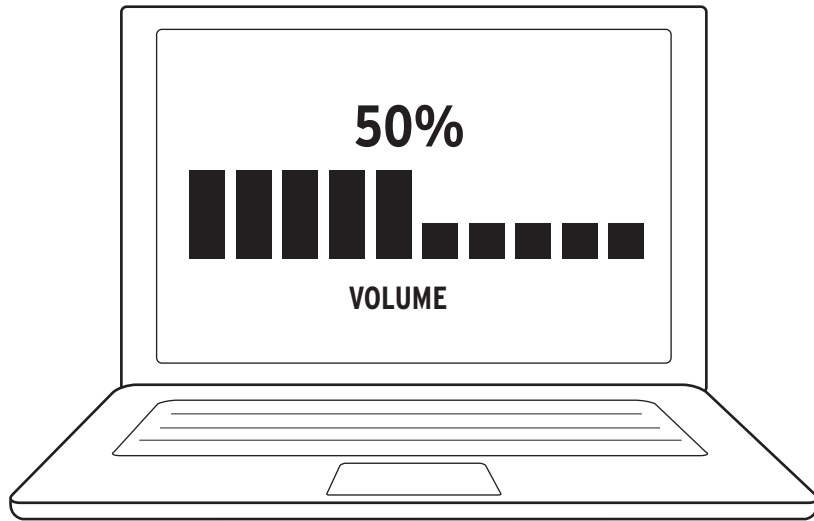

# BLUETOOTH® DISCONNECT

DÉCONNEXION BLUETOOTH® DESCONECTAR BLUETOOTH® BLUETOOTH® TRENNEN SCOLLEGARE BLUETOOTH® DESLIGAR BLUETOOTH® 蓝牙®断开连接

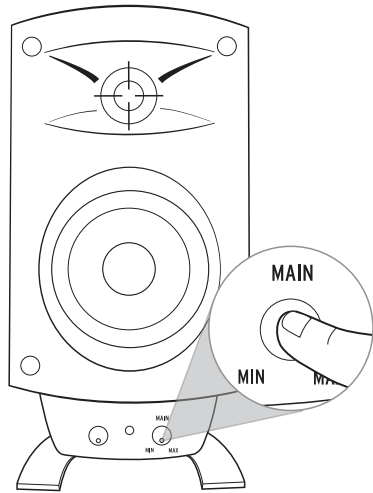

1

## Press

Presse  
Oprima  
drücken  
Premere  
Pressionar  
按

2

## Disconnect

Déconnecter  
Desconectar  
Trennen  
Scollegare  
Desconectar  
切断

OR

OU  
O BIEN  
ODER  
OPPURE  
OU  
或

1

## Hold 3 Seconds

Appuyer pendant 3 secondes  
Mantenga oprimido durante 3 segundos  
3 Sekunden gedrückt halten  
Tenere premuto per 3 secondi  
Manter pressionado por 3 segundos  
保持 3 秒

2

## Standby Mode\*

Mode Veille  
Modalidad en Espera  
Standby-modus  
Modalità di Standby  
Modo de Espera  
待机模式

3

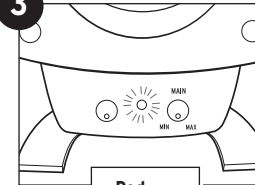

## Red

Rouge  
Rojo  
Rote  
Rosso  
Vermelho  
红

\*Note: Standby mode only available on 230V model. • Remarque: le mode veille est uniquement disponible sur le modèle 230V. • Nota: el modo de espera solo está disponible en el modelo de 230V.

• Hinweis: Der Standby-Modus ist nur beim 230-V-Modell verfügbar. • Nota: la modalità Standby è disponibile solo sul modello 230V. • Nota: Modo de espera apenas disponível no modelo de 230V.

• 注意：待机模式仅适用于230V型号。

For more in-depth information and troubleshooting instructions visit [KLIPSCH.COM/promedia](https://klipsch.com/promedia)

Pour plus d'informations et des instructions de dépannage détaillées, consultez [Klipsch.com/promedia](https://klipsch.com/promedia)

Hay información más detallada e instrucciones de detección y reparación de averías en [Klipsch.com/promedia](https://klipsch.com/promedia)

Detalliertere Anweisungen und Hinweise zur Problembhebung finden Sie unter [Klipsch.com/promedia](https://klipsch.com/promedia)

Per informazioni più dettagliate e istruzioni per la soluzione dei problemi, visitare [Klipsch.com/promedia](https://klipsch.com/promedia)

Para obter informações mais detalhadas e instruções para solucionar problemas, visite o site [Klipsch.com/promedia](https://klipsch.com/promedia)

欲了解更详细的信息和故障排除说明，请访问 [Klipsch.com/promedia](https://klipsch.com/promedia)。



# Klipsch®

## KEEPERS OF THE SOUND™

3502 Woodview Trace, Indianapolis, IN, USA

KLIPSCH.COM



1-800-KLIPSCH ©2016 Klipsch Group, Inc. All rights reserved. Klipsch and Keepers of the Sound are registered trademarks of Klipsch Group, Inc. in the USA and other countries.

A wholly-owned subsidiary of Vox International Corporation.

The Bluetooth® word mark and logos are registered trademarks owned by Bluetooth SIG, Inc. and any use of such mark by Klipsch Group, Inc. is under license.

V05 - 060118