

DIGITAL CAMERA
FINEPIX S9900W Series
FINEPIX S9800 Series
FINEPIX S9700 Series

Owner's Manual

Thank you for your purchase of this product. This manual describes how to use your FUJIFILM digital camera and the supplied software. Be sure that you have read and understood its contents and the warnings in "For Your Safety" (📖 ii) before using the camera.

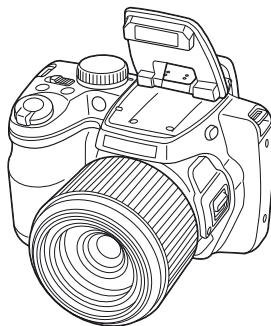

For information on related products, visit our website at
http://www.fujifilm.com/products/digital_cameras/index.html

Before You Begin

First Steps

Basic Photography and Playback

More on Photography

More on Playback

Wireless Networks

Movies

Connections

Menus

Technical Notes

Troubleshooting

Appendix

For Your Safety



Be sure to read this notes before using

Safety Notes



- Make sure that you use your camera correctly. Read these Safety Notes and your *Owner's Manual* carefully before use.
- After reading these Safety Notes, store them in a safe place.

About the Icons

The icons shown below are used in this document to indicate the severity of the injury or damage that can result if the information indicated by the icon is ignored and the product is used incorrectly as a result.

 WARNING	This icon indicates that death or serious injury can result if the information is ignored.
 CAUTION	This icon indicates that personal injury or material damage can result if the information is ignored.

The icons shown below are used to indicate the nature of the information which is to be observed.

	Triangular icons tell you that this information requires attention ("important").
	Circular icons with a diagonal bar tell you that the action indicated is prohibited ("Prohibited").
	Filled circles with an exclamation mark tell you an action that must be performed ("Required").

WARNING



If a problem arises, turn the camera off, remove the battery, disconnect and unplug the AC power adapter.

Continued use of the camera when it is emitting smoke, is emitting any unusual odor, or is in any other abnormal state can cause a fire or electric shock.

- Contact your FUJIFILM dealer.



Do not allow water or foreign objects to enter the camera.

If water or foreign objects get inside the camera, turn the camera off, remove the battery and disconnect and unplug the AC power adapter.

Continued use of the camera can cause a fire or electric shock.

- Contact your FUJIFILM dealer.



Do not use the camera in the bathroom or shower.

This can cause a fire or electric shock.













Never attempt to disassemble or modify (never open the case).









Failure to observe this precaution can cause fire or electric shock.



















Should the case break open as the result of a fall or other accident, do not touch the exposed parts.

Failure to observe this precaution could result in electric shock or injury from touching the damaged parts. Remove the battery immediately, taking care to avoid injury or electric shock, and take the product to the point of purchase for consultation.

 WARNING	
	<p>Do not change, heat or unduly twist or pull the connection cord and do not place heavy objects on the connection cord. These actions could damage the cord and cause a fire or electric shock.</p> <ul style="list-style-type: none"> • If the cord is damaged, contact your FUJIFILM dealer.
	<p>Do not place the camera on an unstable surface. This can cause the camera to fall or tip over and cause injury.</p>
	<p>Never attempt to take pictures while in motion. Do not use the camera while you are walking or driving a vehicle. This can result in you falling down or being involved in a traffic accident.</p>
	<p>Do not touch any metal parts of the camera during a thunderstorm. This can cause an electric shock due to induced current from the lightning discharge.</p>
	<p>Do not use the battery except as specified. Load the battery as aligned with the indicator.</p>
	<p>Do not heat, change or take apart the battery. Do not drop or subject the battery to impacts. Do not store the battery with metallic products. Do not use chargers other than the specified model to charge the battery. Any of these actions can cause the battery to burst or leak and cause fire or injury as a result.</p>
	<p>Use only the battery or AC power adapters specified for use with this camera. Do not use voltages other than the power supply voltage shown. The use of other power sources can cause a fire.</p>
	<p>If the battery leaks and fluid gets in contact with your eyes, skin or clothing. Flush the affected area with clean water and seek medical attention or call an emergency number right away.</p>
	<p>Do not use the charger to charge batteries other than those specified here. The supplied battery charger is for use only with the type of battery supplied with the camera. Using the charger to charge conventional batteries or other types of rechargeable batteries can cause the battery to leak fluid, overheat or burst.</p>

 WARNING	
	<p>Danger of explosion if battery is incorrectly replaced. Replace only with the same.</p>
	<p>Do not use in the presence of flammable objects, explosive gases, or dust.</p>
	<p>When carrying the battery, install it in a digital camera or keep it in the hard case. When storing the battery, keep it in the hard case. When discarding, cover the battery terminals with insulation tape. Contact with other metallic objects or battery could cause the battery to ignite or burst.</p>
	<p>Keep Memory Cards out of the reach of small children. Because Memory Cards are small, they can be swallowed by children. Be sure to store Memory Cards out of the reach of small children. If a child swallows a Memory Card, seek medical attention or call an emergency number.</p>
	<p>Turn the camera off in crowds. The camera emits radio-frequency radiation that may interfere with pacemakers.</p>
	<p>Turn the camera off in the vicinity of automatic doors, public address systems, and other automatically controlled devices. The camera emits radio-frequency radiation that may cause these devices to malfunction.</p>
	<p>Keep the camera at least 22 cm (0.7 ft.) away from people wearing pacemakers. The camera emits radio-frequency radiation that may interfere with pacemakers.</p>

 CAUTION	
	Do not use this camera in locations affected by oil fumes, steam, humidity or dust. This can cause a fire or electric shock.
	Do not leave this camera in places subject to extremely high temperatures. Do not leave the camera in locations such as a sealed vehicle or in direct sunlight. This can cause a fire.
	Keep out of the reach of small children. This product could cause injury in the hands of a child.
	Do not place heavy objects on the camera. This can cause the heavy object to tip over or fall and cause injury.
	Do not move the camera while the AC power adapter is still connected. Do not pull on the connection cord to disconnect the AC power adapter. This can damage the power cord or cables and cause a fire or electric shock.
	Do not use the AC power adapter when the plug is damaged or the plug socket connection is loose. This could cause a fire or electric shock.
	Do not cover or wrap the camera or the AC power adapter in a cloth or blanket. This can cause heat to build up and distort the casing or cause a fire.
	When you are cleaning the camera or you do not plan to use the camera for an extended period, remove the battery and disconnect and unplug the AC power adapter. Failure to do so can cause a fire or electric shock.

 CAUTION	
	When charging ends, unplug the charger from the power socket. Leaving the charger plugged into the power socket can cause a fire.
	Using a flash too close to a person's eyes may temporarily affect the eyesight. Take particular care when photographing infants and young children.
	When a memory card is removed, the card could come out of the slot too quickly. Use your finger to hold it and gently release the card. Injury could result to those struck by the ejected card.
	Request regular internal testing and cleaning for your camera. Build-up of dust in your camera can cause a fire or electric shock. • Contact your FUJIFILM dealer to request internal cleaning every 2 years. • Please note this is not a free of charge service.
	Remove your fingers from the flash window before the flash fires. Failure to observe this precaution could result in burns.
	Keep the flash window clean and do not use the flash if the window is obstructed. Failure to observe these precautions could cause smoke or discoloration.

Power Supply and Battery

* Confirm your battery type before reading the following descriptions.

The following explains proper use of batteries and how to prolong their life. Incorrect use of batteries can cause shorter battery life, as well as leakage, excessive heat, fire or explosion.

1 Camera uses the Rechargeable Lithium-ion Battery

- * When shipped, the battery is not fully charged. Always charge the battery before using it.
- * When carrying the battery, install it in a digital camera or keep it in the soft case.

■ Battery Features

- The battery gradually loses its charge even when not used. Use a battery that has been charged recently (in the last day or two) to take pictures.
- To maximize the life of the battery, turn the camera off as quickly as possible when it is not being used.
- The number of available frames will be lower in cold locations or at low temperatures. Take along a spare fully charged battery. You can also increase the amount of power produced by putting the battery in your pocket or another warm place to heat it and then loading it into the camera just before you take a picture.

If you are using a heating pad, take care not to place the battery directly against the pad. The camera may not operate if you use a depleted battery in cold conditions.

■ Charging the Battery

- Charging times will increase at ambient temperatures below +10°C (+50°F) or above +35°C (+95°F). Do not attempt to charge the battery at temperatures above 40°C (+104°F); at temperatures below 0°C (+32°F), the battery will not charge.
- The Rechargeable Lithium-ion Battery does not need to be fully discharged or exhausted flat before being charged.
- The battery may feel warm after it has been charged or immediately after being used. This is perfectly normal.
- Do not recharge a fully charged battery.

■ Battery Life

At normal temperatures, the battery can be used at least 300 times. If the time for which the battery provides power shortens markedly, this indicates that the battery has reached the end of its effective life and should be replaced.

■ Notes on storage

- If a battery is stored for long periods while charged, the performance of the battery can be impaired. If the battery will not be used for some time, run the battery out before storing it.
- If you do not intend to use the camera for a long period of time, remove the battery from the camera.
- Store the battery in a cool place.
 - The battery should be stored in a dry location with an ambient temperature between +15°C and +25°C (+59°F and +77°F).
 - Do not leave the battery in hot or extremely cold places.

■ Handling the Battery Cautions for Your Safety:

- Do not carry or store battery with metal objects such as necklaces or hairpins.
- Do not heat the battery or throw it into a fire.
- Do not attempt to take apart or change the battery.
- Do not recharge the battery with chargers other than those specified.
- Dispose of used battery promptly.
- Do not drop the battery or otherwise subject it to strong impacts.
- Do not expose the battery to water.
- Always keep the battery terminals clean.

- Do not store batteries in hot places. Also, if you use the battery for a long period, the camera body and the battery itself will become warm. This is normal. Use the AC power adapter if you are taking pictures or viewing images for a long period of time.

2 Camera uses AA Alkaline, Rechargeable Ni-MH (nickel-metal hydride) or AA lithium batteries

- * For details on the batteries that you can use, refer to the *Owner's Manual* of your camera.

■ Cautions for Using Battery

- Do not heat the batteries or throw them into a fire.
- Do not carry or store batteries with metal objects such as necklaces or hairpins.
- Do not expose the batteries to water, and keep batteries from getting wet or stored in moist locations.
- Do not attempt to take apart or change the batteries, including battery casings.
- Do not subject the batteries to strong impacts.
- Do not use batteries that are leaking, deformed, discolored.
- Do not store batteries in warm or humid places.
- Keep the batteries out of reach of babies and small children.
- Make sure that the battery polarity (⊕ and ⊖) is correct.

- Do not use new with used batteries. Do not use charged and discharged batteries together.
- Do not use different types or brands of batteries at the same time.
- If you do not intend to use the camera for a long period of time, remove the batteries from the camera. Note if the camera is left with the batteries removed, the time and date settings are cleared.
- The batteries feel warm right after being used. Before removing the batteries, turn the camera off and wait for the batteries to cool down.
- Since batteries do not work well in cold weather or locations, warm the batteries by placing them inside your garments before use. Batteries do not work well when cold. They will work again when the temperature returns to normal.
- Soil (such as fingerprints) on the battery terminals makes the batteries charge less reducing the number of images. Carefully wipe the battery terminals with a soft dry cloth before loading.



If any liquid at all leaks from the batteries, wipe the battery compartment thoroughly and then load new batteries.



If any battery fluid comes into contact with your hands or clothing, flush the area thoroughly with water. Note that battery fluid can cause loss of eyesight if it gets into your eyes. If this occurs, do not rub your eyes. Flush the fluid out with clean water and contact your physician for treatment.

■ Using the AA-size Ni-MH batteries correctly

- Ni-MH batteries left unused in storage for long periods can become “deactivated”. Also, repeatedly charging Ni-MH batteries that are only partially discharged can cause them to suffer from the “memory effect”. Ni-MH batteries that are “deactivated” or affected by “memory” suffer from the problem of only providing power for a short time after being charged. To prevent this problem, discharge and recharge them several times using the camera’s “Discharging rechargeable batteries” function. Deactivation and memory are specific to Ni-MH batteries and are not in fact battery faults. See *Owner’s Manual* for the procedure for “Discharging rechargeable batteries”.

⚠ CAUTION

Do not use the “Discharging rechargeable batteries” function when alkaline batteries being used.

- To charge Ni-MH batteries, use the quick battery charger (sold separately). Refer to the instructions supplied with the charger to make sure that the charger is used correctly.
- Do not use the battery charger to charge other batteries.
- Note that the batteries feel warm after being charged.
- Due to the way the camera is constructed, a small amount of current is used even when the camera is turned off. Note in particular that leaving Ni-MH batteries in the camera for a long period will over-discharge the batteries and may render them unusable even after recharging.
- Ni-MH batteries will self-discharge even when not used, and the time for which they can be used may be shortened as a result.
- Ni-MH batteries will deteriorate rapidly if over-discharged (e.g. by discharging the batteries in a flashlight). Use the “Discharging rechargeable batteries” function provided in the camera to discharge the batteries.

- Ni-MH batteries have a limited service life. If a battery can only be used for a short time even after repeated discharge-charge cycles, it may have reached the end of its service life.

■ Disposing of Batteries

CAUTION: When disposing of batteries, do so in accordance with your local waste disposal regulations.

3 Notes on both models (1 2)

■ AC Power Adapter

Always use the AC Power Adapter with the camera. The use of an AC Power adapter other than FUJIFILM AC Power Adapter can be damaged to your digital camera.

For details on the AC power adapter, refer to the *Owner’s Manual* of your camera.

- Use the AC power adapter for indoor use only.
- Plug the connection cord plug securely into the DC input terminal.
- Turn off the FUJIFILM Digital camera before disconnecting the cord from the DC input terminal. To disconnect, pull out the plug gently. Do not pull on the cord.
- Do not use the AC power adapter with any device other than your camera.
- During use, the AC power adapter will become hot to the touch. This is normal.

- Do not take apart the AC power adapter. Doing so could be dangerous.
- Do not use the AC power adapter in a hot and humid place.
- Do not subject the AC power adapter to strong shocks.
- The AC power adapter may emit a humming. This is normal.
- If used near a radio, the AC power adapter may cause static. If this happens, move the camera away from the radio.

Before Using the Camera

Do not aim the camera at extremely bright light sources, such as the sun in a cloudless sky. Failure to observe this precaution could damage the camera image sensor.

Test Shots Prior to Photography

For important photographs (such as weddings and overseas trips), always take a test shot and view the image to make sure that the camera is working normally.

- FUJIFILM Corporation cannot accept liability for any incidental losses (such as the costs of photography or the loss of income from photography) incurred as a result of faults with this product.

Notes on Copyright

Images recorded using your digital camera system cannot be used in ways that infringe copyright laws without the consent of the owner,

unless intended only for personal use. Note that some restrictions apply to the photographing of stage performances, entertainments and exhibits, even when intended purely for personal use. Users are also asked to note that the transfer of Memory Card containing images or data protected under copyright laws is only permissible within the restrictions imposed by those copyright laws.

Handling Your Digital Camera

To ensure that images are recorded correctly, do not subject the camera to impact or shock while an image is being recorded.

Liquid Crystal

If the LCD monitor is damaged, take particular care with the liquid crystal in the monitor. If any of the following situations arise, take the urgent action indicated.

- If liquid crystal comes in contact with your skin:
Wipe the area with a cloth and then wash thoroughly with soap and running water.
- If liquid crystal gets into your eye:
Flush the affected eye with clean water for at least 15 minutes and then seek medical assistance.
- If liquid crystal is swallowed:
Flush your mouth thoroughly with water. Drink large quantities of water and induce vomiting. Then seek medical assistance.

Although the LCD panel is produced with highly sophisticated technologies, there may be black spots or permanently lit spots. This is not a malfunction, and does not affect recorded images.

Trademark Information

xD-Picture Card and  are trademarks of FUJIFILM Corporation. The typefaces included herein are solely developed by DynaComware Taiwan Inc. Macintosh, QuickTime, and Mac OS are trademarks of Apple Inc. in the U.S.A. and other countries. Windows 8, Windows 7, Windows Vista, and the Windows logo are trademarks of the Microsoft group of companies. Wi-Fi® and Wi-Fi Protected Setup® are registered trademarks of the Wi-Fi Alliance. Adobe and Adobe Reader are either trademarks or registered trademarks of Adobe Systems Incorporated in the U.S.A. and/or other countries. The SDHC and SDXC logos are trademarks of SD-3C, LLC. The HDMI logo is a trademark. YouTube is a trademark of Google Inc. Facebook is a trademark of Facebook, Inc. All other trade names mentioned in this manual are the trademarks or registered trademarks of their respective owners.

Notes on Electrical Interference

If the camera is to be used in hospitals or aircrafts, please note that this camera may cause interference to other equipment in the hospital or aircraft. For details, please check with the applicable regulations.

Exif Print (Exif ver. 2.3)

Exif Print Format is a newly revised digital camera file format that contains a variety of shooting information for optimal printing.

IMPORTANT NOTICE: Read Before Using the Software

Direct or indirect export, in whole or in part, of licensed software without the permission of the applicable governing bodies is prohibited.

IMPORTANT:

Read the following notices before using the camera's built-in wireless transmitter.

- ☒ This product, which contains encryption function developed in the United States, is controlled by the United States Export Administration Regulations and may not be exported or re-exported to any country to which the United States embargoes goods.

■ **Use only as part of a wireless network.**

FUJIFILM does not accept liability for damages resulting from unauthorized use. Do not use in applications requiring a high degree of reliability, for example in medical devices or other systems that may directly or indirectly impact human life. When using the device in computer and other systems that demand a greater degree of reliability than wireless networks, be sure to take all necessary precautions to ensure safety and prevent malfunction.

■ **Use only in the country in which the device was purchased.**

This device conforms to regulations governing wireless network devices in the country in which it was purchased. Observe all location regulations when using the device. FUJIFILM does not accept liability for problems arising from use in other jurisdictions.

■ **Wireless data (images) may be intercepted by third parties.**

The security of data transmitted over wireless networks is not guaranteed.

■ **Do not use the device in locations subject to magnetic fields, static electricity, or radio interference.**

Do not use the transmitter in the vicinity of microwave ovens or in other locations subject to magnetic fields, static electricity, or radio interference that may prevent reception of wireless signals. Mutual interference may occur when the transmitter is used in the vicinity of other wireless devices operating in the 2.4 GHz band.

■ **The wireless transmitter operates in the 2.4 GHz band using DSSS and OFDM modulation.**

**Wireless Network Devices:
Cautions**

■ **This device operates on the same frequency as commercial, educational, and medical devices and wireless transmitters.**

It also operates on the same frequency as licensed transmitters and special unlicensed low-voltage transmitters used in RFID tracking systems for assembly lines and in other similar applications.

■ **To prevent interference with the above devices, observe the following precautions.**

Confirm that the RFID transmitter is not in operation before using this device. If the device causes interference to premises radio stations used for RFID tracking, immediately either relocate this device or stop the emission of radio waves. If you notice that this device causes interference in low-voltage RFID tracing systems, contact a FUJIFILM representative.

2.4DS/OF4

This sticker indicates that this device operates in the 2.4 GHz band using DSSS and OFDM modulation and may cause interference at distances of up to 40 m.

About This Manual

Before using the camera, read this manual and the warnings on pages ii–viii. For information on specific topics, consult the sources below.

✓ **Table of Contents** **x**

The “Table of Contents” gives an overview of the entire manual. The principal camera operations are listed here.

✓ **Troubleshooting** **109**

Having a specific problem with the camera? Find the answer here.

✓ **Warning Messages and Displays** **117**

Find out what’s behind that flashing icon or error message in the display.

This manual is for use with **FINEPIX S9900W Series** and **FINEPIX S9800 Series/FINEPIX S9700 Series** cameras. With the exception of the features below, operations for these models are identical.

Model	Wireless Network features
FINEPIX S9900W Series	Available
FINEPIX S9800 Series/FINEPIX S9700 Series	Not available

Memory Cards

Pictures can be stored in an optional SD, SDHC, and SDXC memory cards ( 11), referred to in this manual as “memory cards”.

Temperature Warning

The camera will turn off automatically before its temperature or the temperature of the battery rise above safe limits. Pictures taken when a temperature warning is displayed may exhibit higher levels of “noise” (mottling). Turn the camera off and wait for it to cool before turning it on again.

Table of Contents

For Your Safety	ii
Safety Notes	ii
About This Manual	ix

Before You Begin

Introduction	1
Symbols and Conventions	1
Supplied Accessories	1
Parts of the Camera	2
Camera Displays	4
The Mode Dial	7









First Steps

The Strap and Lens Cap	8
Inserting the Batteries	9
Inserting a Memory Card	11
Turning the Camera On and Off	14
Shooting Mode	14
Playback Mode	14
Basic Setup	15



Basic Photography and Playback

Taking Pictures in SR/AUTO (Scene Recognition) Mode	16
Viewing Pictures	21

More on Photography

Shooting Mode	22
SR/AUTO SCENE RECOGNITION	22
AUTO	22
Adv. ADVANCED	22
SP SCENE POSITION	26
 MOTION PANORAMA 360	27
P: PROGRAM AE	29
S: SHUTTER PRIORITY AE	30
A: APERTURE PRIORITY AE	30
M: MANUAL	31
C: CUSTOM MODE	32
Intelligent Face Detection	33
Focus Lock	35
 Macro and Super Macro Modes (Close-ups)	37
 Using the Flash (Intelligent Flash)	38
 Using the Self-Timer	40
 Interval shooting	41
 INSTANT ZOOM	42
The Fn Button	45
 Continuous Shooting (Burst Mode)	46
 Exposure Compensation	49

More on Playback

Playback Options	51
Continuous Shooting	51
Playback Zoom.....	51
★ Favorites: Rating Pictures	52
Multi-Frame Playback.....	53
Viewing Panoramas	54
 PhotoBook Assist	55
Creating a PhotoBook	55
Viewing PhotoBooks	56
Editing and Deleting PhotoBooks	56
 Image Search	57
 Deleting Pictures	58

Wireless Networks

Using Wireless Networks (S9900W Series Only)	59
Connecting with smartphones.....	59
Saving Pictures to a Computer	59











Movies























Recording Movies	60
Movie Frame Size	62
 Viewing Movies	63

Connections

Viewing Pictures on TV	64
Connecting the Camera to High Definition (HD) TVs	64
Printing Pictures via USB	65
Connecting the Camera	65
Printing Selected Pictures	65
Printing the DPOF Print Order.....	66
Creating a DPOF Print Order	68
Viewing Pictures on a Computer	71
Windows: Installing MyFinePix Studio.....	71
Importing pictures or movies to Mac (Macintosh)	73
Connecting the Camera	73

Menus

Using the Menus: Shooting Mode	75
Using the Shooting Menu.....	75
Shooting Menu Options.....	76
 ISO	78
 IMAGE SIZE	78
 IMAGE QUALITY	79
 FINEPIX COLOR	80
 WHITE BALANCE	80
 PHOTOMETRY	81
 AF MODE	82
 MOVIE AF MODE	83
 AE BKT EV STEPS	83
 FLASH	83

Using the Menus: Playback Mode	84
Using the Playback Menu.....	84
Playback Menu Options.....	85
 MOVIE EDIT.....	86
 MARK FOR UPLOAD.....	87
 SLIDE SHOW.....	89
 RED EYE REMOVAL.....	90
 PROTECT.....	91
 CROP.....	92
 RESIZE.....	93
 IMAGE ROTATE.....	94
 COPY.....	95
 DISP. ASPECT.....	95
The Setup Menu	96
Using the Setup Menu.....	96
Setup Menu Options.....	97
 TIME DIFFERENCE.....	100
 FORMAT.....	101
 IMAGE DISP.	101
 FRAME NO.	102
 PLAYBACK VOLUME.....	102
 LCD BRIGHTNESS.....	102
 LCD POWER SAVE.....	102
 AUTO POWER OFF.....	103
 DIGITAL IMAGE STABILIZER.....	103
 INTELLIGENT DIGITAL ZOOM.....	103
 DISCHARGE (Ni-MH Batteries Only).....	104
 DATE STAMP.....	105

Technical Notes

Optional Accessories	106
Accessories from FUJIFILM.....	107
Caring for the Camera	108

Troubleshooting

Troubleshooting	109
Warning Messages and Displays	117

Appendix

Memory Card Capacity	121
Specifications	122

Introduction

Symbols and Conventions

The following symbols are used in this manual:

: This information should be read before use to ensure correct operation.

: Points to note when using the camera.

: Additional information that may be helpful when using the camera.

: Other pages in this manual on which related information may be found.

Menus and other text in the camera monitor are shown in bold. In the illustrations in this manual, the monitor display may be simplified for explanatory purposes.

Supplied Accessories

The following items are included with the camera:

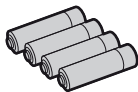

AA alkaline (LR6) batteries (x4)

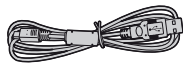

USB cable

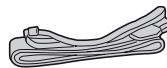

Strap



Lens cap

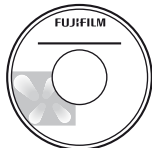



CD-ROM

• *Basic Manual*

Parts of the Camera

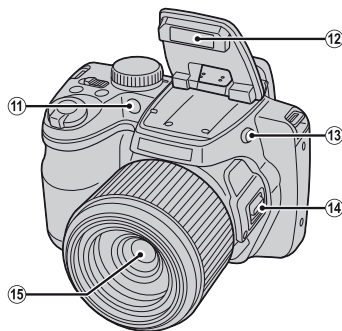
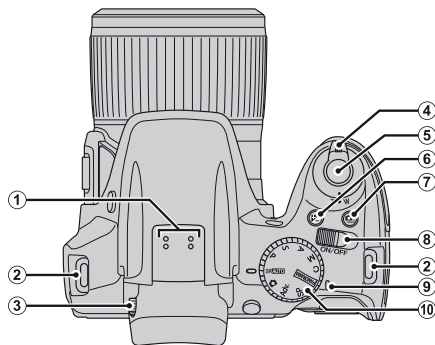
For more information, refer to the page listed to the right of each item.



① Microphone.....	60	⑦  (burst mode) button.....	46	⑫ Flash.....	38
② Strap eyelet.....	8	⑧ ON/OFF switch.....	14	⑬ Flash pop-up button.....	38
③ Diopter adjustment control.....	6	⑨ Indicator lamp.....	20	⑭ Side lever.....	17
④ Zoom control.....	17, 51, 53	⑩ Mode dial.....	7	⑮ Lens.....	14, 122
⑤ Shutter button.....	19	⑪ AF-assist illuminator.....	36		
⑥  (exposure compensation) button.....	49	Self-timer lamp.....	41		

* Illustrations in this manual may be simplified for explanatory purposes.

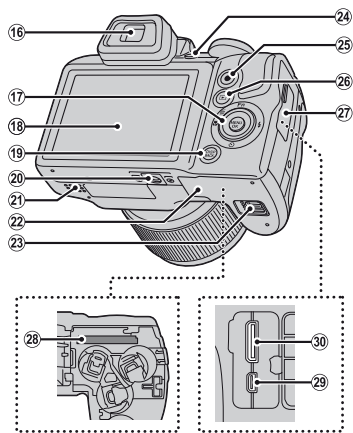

- ①⑥ Electronic viewfinder 6
- ①⑦ Selector button (see below) 6
- ①⑧ Monitor 4
- ①⑨ **DISP** (display)/**BACK** button 5
- ②① Tripod mount 63
- ②① Speaker 63
- ②② Battery-chamber cover 9
- ②③ Battery-chamber latch 9
- ②④ **EVF/LCD** (display selection) button 6
- ②⑤ (movie recording) button 60
- ②⑥ (playback) button 21, 51
- ②⑦ Terminal cover 64, 65, 73
- ②⑧ Memory card slot 12
- ②⑨ USB multi-connector 65, 73
- ③① HDMI Mini Connector 64

● The Selector Button

Move cursor up

Fn (Function) button (📖 45)

(delete) button (📖 58)

MENU/OK button

(📖 15, 75, 84, 96)

Move cursor left

(macro) button (📖 37)

Move cursor right

(flash) button (📖 38)

Move cursor down

(self-timer) button (📖 40)

Command dial

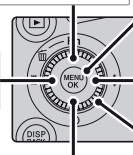

Camera Displays

The following indicators may appear during shooting and playback. The indicators displayed vary with camera settings.

Shooting

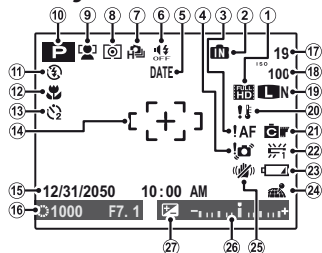

* **IN**: indicates that no memory card is inserted and that pictures will be stored in the camera's internal memory (12).

①	Movie mode	62	⑮	Date and time	15
②	Internal memory indicator*		⑯	Shutter speed and aperture	29
③	Focus warning	19	⑰	Number of available frames	121
④	Blur warning	38, 112, 117	⑱	Sensitivity	78
⑤	Date stamp	105	⑳	Image size/quality	78, 79
⑥	Silent mode	97	㉑	Temperature warning	ix
⑦	Burst mode	46	㉒	FinePix color	80
⑧	Metering	81	㉓	White balance	80
⑨	Intelligent Face Detection indicator	33	㉔	Battery level	17
⑩	Shooting mode	22	㉕	Location data download status (S9900W Series Only)	99
⑪	Flash mode	38	㉖	IS mode	18
⑫	Macro (close-ups) mode	37	㉗	Exposure indicator	49
⑬	Self-timer indicator	40	㉘	Exposure compensation indicator	49
⑭	Focus frame	35			

Playback

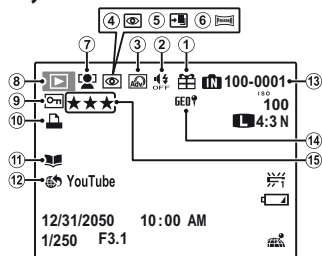

①	Gift image	51	⑨	Protected image	91
②	Silent mode	97	⑩	DPOF print indicator	68
③	Advanced Filter	23	⑪	Photobook assist indicator	55
④	Red-eye removal indicator	90	⑫	Mark for upload to	87
⑤	Pro low-light mode	24	⑬	Frame number	102
⑥	Motion panorama 360	27, 54	⑭	Location data (S9900W Series Only)	99
⑦	Intelligent Face Detection indicator	33	⑮	Rating	52
⑧	Playback mode indicator	21, 51			

Hiding and Viewing Indicators

Press **DISP/BACK** to cycle through shooting and playback indicators as follows:

- **Shooting:** Indicators displayed/indicators hidden/best framing/HD framing/histogram
- **Playback:** Indicators displayed/indicators hidden/★ favorites (📖 52)/photo info

Histograms

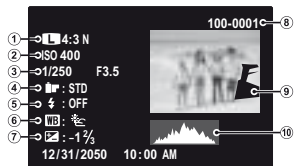

- ① Image quality and size
- ② Sensitivity
- ③ Shutter speed/aperture
- ④ FinePix color
- ⑤ Flash mode
- ⑥ White balance
- ⑦ Exposure compensation
- ⑧ Frame number
- ⑨ Picture (overexposed areas blink on and off)
- ⑩ Histogram

Overexposed areas blink on and off.



Histograms show the distribution of tones in the image. Brightness is shown by the horizontal axis, the number of pixels by the vertical axis.

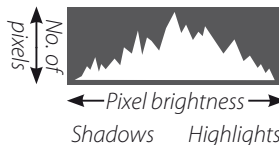

Optimal exposure: Pixels are distributed in an even curve throughout the tone range.



Overexposed: Pixels are clustered at the right side of the graph.



Underexposed: Pixels are clustered at the left side of the graph.



●● The Electronic Viewfinder (EVF)

The electronic viewfinder provides the same information as the monitor, and can be used when bright lighting conditions make the display in the monitor difficult to see. To switch between the monitor and electronic viewfinder, press the **EVF/LCD** button (your selection remains in effect when the camera is turned off or the mode dial is rotated to another setting).

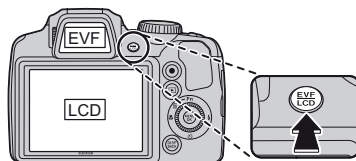

●● Bright Ambient Lighting

Reflections and glare caused by bright ambient lighting may make it hard to see the display in the monitor, particularly when the camera is used outdoors. This can be addressed by holding the **EVF/LCD** button to trigger outdoor mode. Outdoor mode can also be enabled using the  **MONITOR SUNLIGHT MODE** option in the setup menu (📖 97).

●● Diopter adjustment control

The camera is equipped with diopter adjustment to accommodate individual differences in vision. Slide the diopter adjustment control up and down until the viewfinder display is in sharp focus.

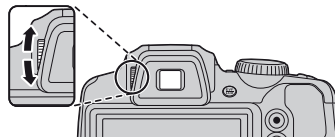

Strong sunlight focused through the viewfinder may damage the panel of electronic viewfinder (EVF). Do not aim the electronic viewfinder at the sun.

The Mode Dial

To select a shooting mode, align the mode icon with the mark next to the mode dial.

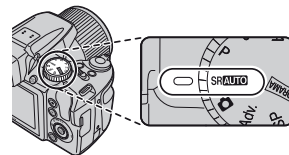

SR AUTO (SCENE RECOGNITION): A “point-and-shoot” mode in which the camera automatically adjusts settings to suit the scene (📖 16).

📷 (AUTO): A simple “point-and-shoot” mode recommended for first-time users of digital cameras (📖 22).

Adv. (ADVANCED): Sophisticated techniques made easy (📖 22).

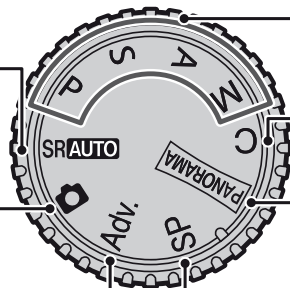

P, S, A, M: Select for full control over camera settings, including aperture (**M** and **A**) and/or shutter speed (**M** and **S**) (📖 29).

C (CUSTOM): Recall stored settings for modes **P**, **S**, **A**, and **M** (📖 32).

PANORAMA (MOTION PANORAMA): Take a series of photographs and combine them to form a panorama (📖 27).

SP (SCENE POSITION): Choose a scene suited to the subject or shooting conditions and let the camera do the rest (📖 26).

The Strap and Lens Cap

Attaching the Strap

Attach the strap to the two strap eyelets as shown below.

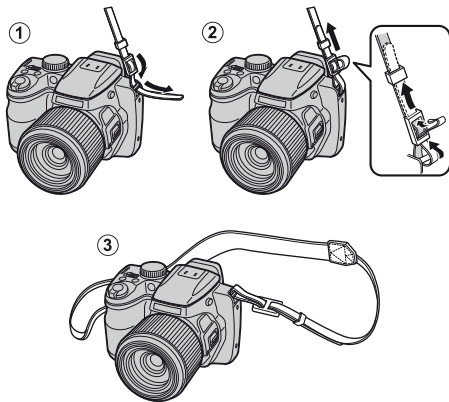

 To avoid dropping the camera, be sure the strap is correctly secured.

The Lens Cap

Attach the lens cap as shown.

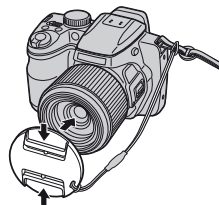

To avoid losing the lens cap, pass the supplied string through the eyelet (1) and secure the lens cap to the strap (2).

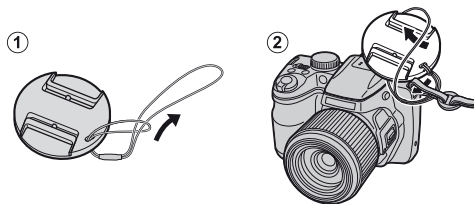

Inserting the Batteries

The camera takes four AA alkaline, lithium, or rechargeable Ni-MH batteries. A set of four alkaline batteries is supplied with the camera. Insert the batteries in the camera as described below.

1 Open the battery-chamber cover.

Slide the battery-chamber latch in the direction shown and open the battery-chamber cover.

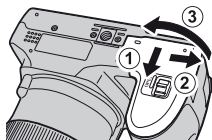

Be sure the camera is off before opening the battery-chamber cover.



- Do not open the battery-chamber cover when the camera is on. Failure to observe this precaution could result in damage to image files or memory cards.
- Do not use excessive force when handling the battery-chamber cover.

2 Insert the batteries.

Insert the batteries in the orientation shown by the “+” and “-” marks inside the battery chamber.

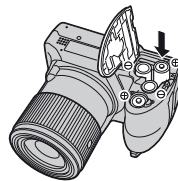

- Insert the batteries in the correct orientation.
- **Never use batteries with peeling or damaged casing or mix old and new batteries, batteries with different charge levels, or batteries of different types.**

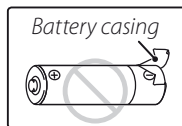

- Failure to observe these precautions could result in the batteries leaking or overheating.
- **Never use manganese or Ni-Cd batteries.**
 - The capacity of alkaline batteries varies with the manufacturer and drops at temperatures below 10°C/50°F; Ni-MH batteries are recommended.
 - Fingerprints and other soil on the battery terminals can shorten battery life.

3 Close the battery-chamber cover.

Close the battery-chamber cover and slide it in until the latch clicks into place.



Do not use force. If the battery-chamber cover does not close, check that the batteries are in the correct orientation and try again.



Using an AC Power Adapter

The camera can be powered by an optional AC power adapter and DC coupler (sold separately).

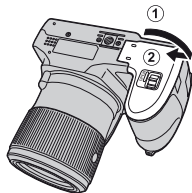

Choosing the Battery Type

After replacing the batteries with batteries of a different type, select the battery type using the **BATTERY TYPE** option in the setup menu (99) to ensure that the battery level is displayed correctly and the camera does not turn off unexpectedly.



Inserting a Memory Card

The camera can store pictures on SD, SDHC, and SDXC memory cards (sold separately).

■ **Compatible Memory Cards**

FUJIFILM and SanDisk SD, SDHC, and SDXC memory cards have been approved for use in the camera. A complete list of approved memory cards is available at http://www.fujifilm.com/products/digital_cameras/index.html. Operation is not guaranteed with other cards. The camera can not be used with *xD-Picture Cards* or MultiMediaCard (MMC) devices.



Memory cards can be locked, making it impossible to format the card or to record or delete images. Before inserting a memory card, slide the write-protect switch to the unlocked position.

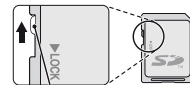

Write-protect
switch

■ Inserting a Memory Card

1 Open the battery-chamber cover.



Be sure the camera is off before opening the battery-chamber cover.

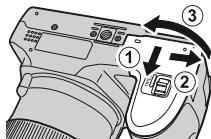

2 Insert the memory card.

Holding the memory card in the orientation shown below, slide it in until it clicks into place at the back of the slot.

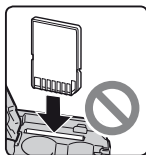
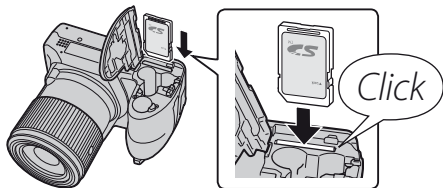

Be sure card is in correct orientation; do not insert at an angle or use force.

3 Close the battery-chamber cover.

Close the battery-chamber cover and slide it in until the latch clicks into place.

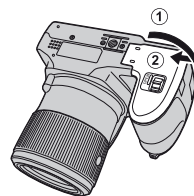

● Removing Memory Cards

After confirming that the camera is off, press the card in and then release it slowly. The card can now be removed by hand.

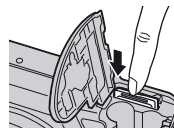

- The memory card may spring out if you remove your finger immediately after pushing the card in.
- Memory cards may be warm to the touch after being removed from the camera. This is normal and does not indicate a malfunction.



- **Do not turn the camera off or remove the memory card while the memory card is being formatted or data are being recorded to or deleted from the card.** Failure to observe this precaution could damage the card.
- Format SD/SDHC/SDXC memory cards before first use, and be sure to reformat all memory cards after using them in a computer or other device. For more information on formatting memory cards, see page 101.
- Memory cards are small and can be swallowed; keep out of reach of children. If a child swallows a memory card, seek medical assistance immediately.
- miniSD or microSD adapters that are larger or smaller than the standard dimensions of an SD/SDHC/SDXC card may not eject normally; if the card does not eject, take the camera to an authorized service representative. Do not forcibly remove the card.
- Do not affix labels to memory cards. Peeling labels can cause camera malfunction.
- Movie recording may be interrupted with some types of SD/SDHC/SDXC memory card. Use a CLASS10 card or better when shooting HD movies, Full HD movies or high-speed movies.
- Formatting a memory card in the camera creates a folder in which pictures are stored. Do not rename or delete this folder or use a computer or other device to edit, delete, or rename image files. Always use the camera to delete pictures from memory cards; before editing or renaming files, copy them to a computer and edit or rename the copies, not the originals.

Turning the Camera On and Off

Shooting Mode

Slide the **ON/OFF** switch in the direction shown below. The lens will extend automatically.

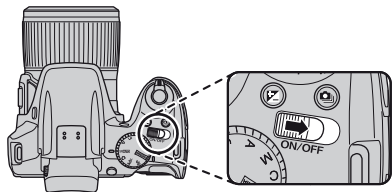

Slide the **ON/OFF** switch to turn the camera off.



Switching to Playback Mode

Press the  button to start playback. Press the shutter button halfway to return to shooting mode.



- Be sure that the lens cap is removed before turning the camera on.
- Forcibly preventing the lens from extending could cause damage or product malfunction.
- Pictures can be affected by fingerprints and other marks on the lens. Keep the lens clean.
- The **ON/OFF** button does not completely disconnect the camera from its power supply.

Auto Power Off

The camera will turn off automatically if no operations are performed for the length of time selected in the  **AUTO POWER OFF** menu (see page 103). To turn the camera on, use the **ON/OFF** switch or press the  button for about a second.

Playback Mode

To turn the camera on and begin playback, press the  button for about a second.

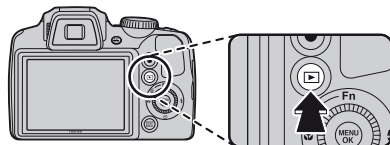

Press the  button again or slide the **ON/OFF** switch to turn the camera off.

Switching to Shooting Mode

To exit to shooting mode, press the shutter button halfway. Press the  button to return to playback.

Basic Setup

A language-selection dialog is displayed the first time the camera is turned on. Set up the camera as described below (for information on resetting the clock or changing languages, see page 97).

1 Choose a language.



1.1 Press the selector up or down to highlight a language.

1.2 Press **MENU/OK**.



2 Set the date and time.

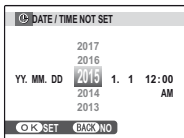

2.1 Press the selector left or right to highlight the year, month, day, hour, or minute and press up or down to change. To change the order in which the year, month, and day are displayed, highlight the date format and press the selector up or down.

2.2 Press **MENU/OK**. A battery type message will be displayed; if the type differs from the type inserted in the camera, use the setup menu **BATTERY TYPE** option (📖 99) to specify the correct type.



The Camera Clock

If the batteries are removed for an extended period, the camera clock and battery type will be reset and the language-selection dialog will be displayed when the camera is turned on. If the batteries are left in the camera for about 10 hours, the battery can be removed for about 24 hours without resetting the clock, language, or battery type.

Taking Pictures in **SR/AUTO** (Scene Recognition) Mode

This section describes how to take pictures in **SR/AUTO** mode.

- 1 Turn the camera on.
Slide the **ON/OFF** switch to turn the camera on.

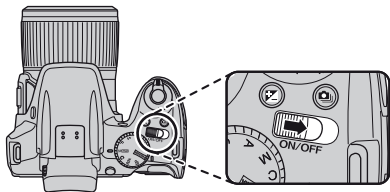

- 2 Select **SR/AUTO** mode.
Rotate the mode dial to **SR/AUTO**.

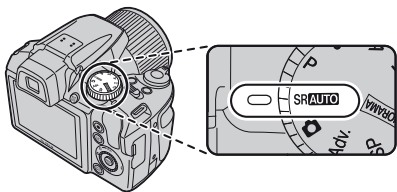

SR/AUTO

In this mode, the camera automatically analyzes the composition and selects a scene according to shooting conditions and the type of subject:



- (PORTRAIT): Human portrait *Selected scene* subject.
- (LANDSCAPE): Man-made or natural landscape.
- (NIGHT): Poorly-lit landscape.
- (MACRO): Subject close to camera.
- (NIGHT PORTRAIT): Poorly-lit portrait subject.
- (BACKLIT PORTRAIT): Back-lit portrait subject.
- (AUTO) is selected if none of the above are detected.

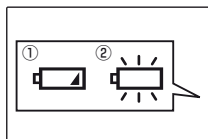

3 Check the battery level.

Check the battery level in the display.



Indicator	Description
NO ICON	Batteries are partially discharged.
①  (red)	Batteries are low. Replace as soon as possible.
②  (blinks red)	Batteries are exhausted. Turn camera off and replace batteries.



A battery warning may not be displayed before the camera turns off, particularly if batteries are reused after having once been exhausted. Power consumption varies greatly from mode to mode; the low battery warning () may not be displayed or may be displayed only briefly before the camera turns off in some modes or when switching from shooting to playback mode.

4 Frame the picture.

Use the zoom control or side lever to frame the picture in the display.

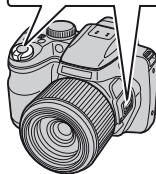
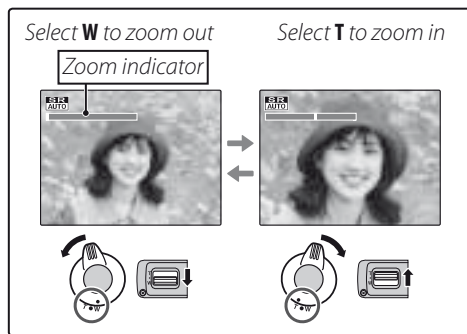





- When the side lever is set to **H**, **M** or **L**, the side lever functions as same as the zoom lever.
- When setting the side lever to **H**, the side lever can zoom faster than zoom lever. In the same way when setting the side lever to **L**, the side lever can zoom slower than zoom lever.
- When using the zoom control and side lever simultaneously, the zoom control is activated.

Focus Lock

Use focus lock ( 35) to focus on subjects that are not in the focus frame.

Auto back zoom

In the setup menu ( 98), you can change the setting of the side lever. Select  **SIDE ZOOM LEVER** then **AUTO BACK** to enable auto back zoom. Auto back zoom allows the camera to zoom out and in quickly. It makes it easy to find the lost subject when zooming in.

Holding the Camera

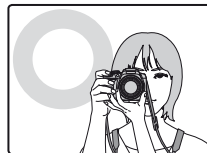

Hold the camera steady with both hands and brace your elbows against your sides. Shaking or unsteady hands can blur your shots.



To prevent pictures that are out of focus or too dark (underexposed), keep your fingers and other objects away from the lens and flash.



Avoiding Blurred Pictures

If the subject is poorly lit, blurring caused by camera shake can be reduced using the  **IS MODE** option in the setup menu ( 98). In  mode, blur caused by subject movement is also reduced.

Note that blurring may still occur depending on the scene.

5 Focus.

Press the shutter button halfway to focus.



The lens may make a noise when the camera focuses; this is normal. In **SRAUTO** mode, the camera continuously adjusts focus and searches for faces, increasing the drain on the battery.

If the camera is able to focus, it will beep twice and the indicator lamp will glow green.

If the camera is unable to focus, the focus frame will turn red, **!AF** will be displayed, and the indicator lamp will blink green. Change the composition or use focus lock (📖 35).

6 Shoot.

Smoothly press the shutter button the rest of the way down to take the picture.

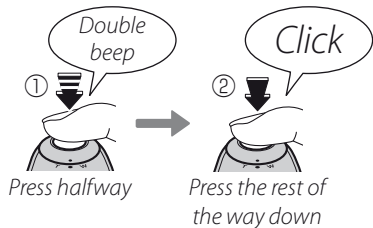

The Shutter Button

The shutter button has two positions. Pressing the shutter button halfway (①) sets focus and exposure; to shoot, press the shutter button the rest of the way down (②).

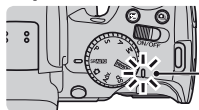

If the subject is poorly lit, the AF-assist illuminator may light to assist focus (📖 36). For information on using the flash when lighting is poor, see page 38.

The Indicator Lamp



Indicator lamp

The indicator lamp shows camera status as follows:

Indicator lamp	Camera status
Glows green	Focus locked.
Blinks green	Blur, focus, or exposure warning. Picture can be taken.
Blinks green and orange	Recording pictures. Additional pictures can be taken.
Glows orange	Recording pictures. No additional pictures can be taken at this time.
Blinks orange	Flash charging; flash will not fire when picture is taken.
Blinks red	Lens or memory error (memory card full or not formatted, format error, or other memory error).

Warnings

Detailed warnings appear in the display. See pages 117–120 for more information.

Viewing Pictures

Pictures can be viewed in the monitor. When taking important photographs, take a test shot and check the results.

- 1 Press the  button.

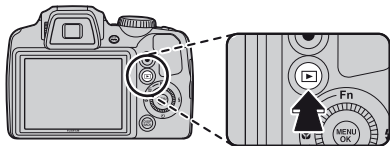

The most recent picture will be displayed in the monitor.



- 2 View additional pictures.

Press the selector right to view pictures in the order recorded, left to view pictures in reverse order.



Press the shutter button to exit to shooting mode.

Deleting Pictures

To delete the picture currently displayed in the monitor, press the selector up () . The following dialog will be displayed.



- Select **FRAME** and press **MENU/OK**.

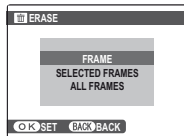

- To delete the picture, press **MENU/OK**.

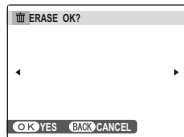

To exit without deleting the picture, press **DISP/BACK**.

The Playback Menu

Pictures can also be deleted from the playback menu ( 84).

Shooting Mode

Choose a shooting mode according to the scene or type of subject. To choose a shooting mode, rotate the mode dial to the desired setting (📖 7). The following modes are available:

SRAUTO SCENE RECOGNITION

The camera automatically analyzes the composition and selects the appropriate scene mode according to the subject and shooting conditions (📖 16).

📷 AUTO

Choose for crisp, clear snapshots. This mode is recommended in most situations.

Adv. ADVANCED

This mode combines “point-and-shoot” simplicity with sophisticated photographic techniques. The **📷 Adv. MODE** option in the shooting menu can be used to choose from the following advanced modes:

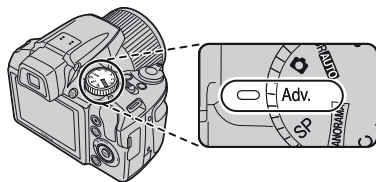

















ADVANCED FILTER

Take photos with filter effects. Select a filter effect and press **MENU/OK**.



Depending on the subject and camera settings, images may in some cases be grainy or vary in brightness and hue.

Filter	Description
 TOY CAMERA ^{*1}	Choose for a retro toy camera effect.
 MINIATURE ^{*2}	The tops and bottoms of pictures are blurred for a diorama effect.
 POP COLOR ^{*1*3}	Create high-contrast images with saturated colors.
 HIGH-KEY ^{*1}	Create bright, low-contrast images.
 LOW-KEY ^{*1}	Create uniformly dark tones with few areas of emphasized highlights.
 DYNAMIC TONE ^{*2}	Dynamic tone expression is used for a fantasy effect.
 FISH-EYE ^{*1*3}	Create a distorting effect of a fisheye lens.
 SOFT FOCUS ^{*2*4}	Create a look that is evenly soft throughout the whole image.
 CROSS SCREEN ^{*2*4}	Create a star pattern where lines radiate out from bright objects.
 SKETCH ^{*1*3}	Create line-drawing-like pictures with contours of subjects remained.
 PARTIAL COLOR (RED) ^{*1*3}	Areas of the image that are the selected color are recorded in that color. All others areas of the image are recorded in black-and-white.
 PARTIAL COLOR (ORANGE) ^{*1*3}	
 PARTIAL COLOR (YELLOW) ^{*1*3}	
 PARTIAL COLOR (GREEN) ^{*1*3}	
 PARTIAL COLOR (BLUE) ^{*1*3}	
 PARTIAL COLOR (PURPLE) ^{*1*3}	

*1 The frame size of movies is set to **640 640×480**. The effect cannot be applied to still pictures that are taken while a movie is recorded.

*2 The filter effect is not applied to movies. The movie recording function is set to normal.

*3 The frame rate of the movie is set to 15 fps.

*4 To check the effect, play the picture after shooting.

PRO LOW-LIGHT

Each time the shutter button is pressed, the camera makes four exposures and combines them into a single photograph. Use to reduce noise and blur when photographing poorly lit subjects or static subjects at high zoom ratios.



A single combined photograph may not be created with some scenes or if the subject or camera moves during shooting. Do not move the camera until shooting is complete.

Pro Low-Light

To save unprocessed copies of pictures taken in these modes, select **ON** for the  **SAVE ORG IMAGE** option in the setup menu (📖 98).



- Keep the camera steady during shooting.
- Frame coverage is reduced.

HDR

Each time the shutter button is pressed, the camera takes a series of shots, each with different exposure. These are combined into a single image, preserving detail in highlights and shadows. Choose for high-contrast scenes.



A single combined photograph may not be created with some scenes or if the subject or camera moves during shooting. Do not move the camera until shooting is complete.

HDR

To save unprocessed copies of pictures taken in this mode, select **ON** for the  **SAVE ORG IMAGE** option in the setup menu (📖 98).



- Keep the camera steady during shooting.
- Frame coverage is reduced.

■ Natural &

This mode helps ensure good results with backlit subjects and in other situations with difficult lighting. Before shooting, raise the flash; pictures can only be taken when the flash is raised. Each time the shutter button is pressed, the camera takes two shots: one shot without the flash to preserve natural lighting, followed immediately by a second shot with the flash. Do not move the camera until shooting is complete.



- Do not use where flash photography is prohibited.
- Only available if memory remains for two pictures.
- Burst mode is not available.

■ Zoom Bracketing

Each time the shutter button is pressed, the camera takes three pictures: one at the current zoom ratio with an image size of **L**, a second zoomed in 1.4× and cropped to **M**, and a third zoomed in 2× and cropped to **S** (pictures will only be taken if there is enough memory for three images). Two frames are displayed to show the areas that will be included in the second and third pictures; the outer frame shows the area that will be recorded at 1.4× zoom, the inner frame the area that will be recorded at 2× zoom.

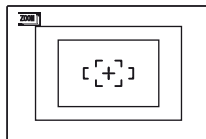







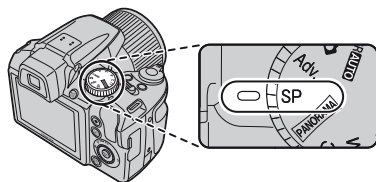







- Digital zoom can not be used. If digital zoom is active when  mode is selected, zoom will be set to the maximum optical zoom position.
- Burst shooting options can not be used.

SP SCENE POSITION

The camera offers a choice of “scenes,” each adapted to particular shooting conditions or a specific type of subject. Use the **SCENE POSITION** option in the shooting menu to choose the scene assigned to the **SP** position on the mode dial.



Scene	Description
 PORTRAIT	Choose this mode for soft-toned portraits with natural skin tones.
 BABY MODE	Choose for natural skin tones when taking portraits of infants. The flash turns off automatically.
 SMILE&SHOOT	The shutter is released automatically when Intelligent Face Detection detects a smiling face.
 LANDSCAPE	Choose this mode for crisp, clear daylight shots of buildings and landscapes.
 SPORT	Choose this mode when photographing moving subjects. Priority is given to faster shutter speeds.
 NIGHT	Choose this mode for poorly lit twilight or night scenes. Sensitivity is automatically raised to reduce blur caused by camera shake.
 NIGHT (TRIPOD)	Choose this mode for slow shutter speeds when shooting at night. Use a tripod to prevent blur.
 FIREWORKS	Slow shutter speeds are used to capture the expanding burst of light from a firework. Rotate the command dial to choose a shutter speed.
 SUNSET	Choose this mode to record the vivid colors in sunrises and sunsets.
 SNOW	Choose for crisp, clear shots that capture the brightness of scenes dominated by shining white snow.
 BEACH	Choose for crisp, clear shots that capture the brightness of sunlit beaches.
 PARTY	Capture indoor background lighting under low-light conditions.
 FLOWER	Choose for vivid close-ups of flowers. The camera focuses in the macro range.
 TEXT	Take clear pictures of text or drawings in print. The camera focuses in the macro range.

MOTION PANORAMA 360

Follow an on-screen guide to take photos that will automatically be joined to form a panorama. The camera zooms all the way out and remains fixed at the widest angle until shooting is complete.



- 1** To select the angle through which you will pan the camera while shooting, press the selector down. Press the selector left or right to highlight an angle and press **MENU/OK**.
- 2** Press the selector right to view a choice of pan directions. Press the selector left or right to highlight a pan direction and press **MENU/OK**.
- 3** Press the shutter button all the way down to start recording. There is no need to keep the shutter button pressed during recording.

- 4** Pan the camera in the direction shown by the arrow. Shooting ends automatically when the progress bar is full and the panorama is complete.

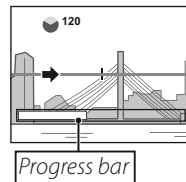

Shooting ends if the shutter button is pressed all the way down during shooting. No panorama will be recorded if the shutter button is pressed before the camera has been panned through 120°.



- Panoramas are created from multiple frames. The camera may in some cases record a greater or lesser angle than selected or be unable to stitch the frames together perfectly. The last part of the panorama may not be recorded if shooting ends before the panorama is complete.
- Shooting may be interrupted if the camera is panned too quickly or too slowly. Panning the camera in a direction other than that shown cancels shooting.
- The desired results may not be achieved with moving subjects, subjects close to the camera, unvarying subjects such as the sky or a field of grass, subjects that are in constant motion, such as waves and waterfalls, or subjects that undergo marked changes in brightness. Panoramas may be blurred if the subject is poorly lit.

**For Best Results**

For best results, move the camera in a small circle at a steady speed, keeping the camera horizontal and being careful only to pan in the direction shown by the guides. If the desired results are not achieved, try panning at a different speed.

P: PROGRAM AE

In this mode, the camera sets exposure automatically. If desired, you can choose different combinations of shutter speed and aperture that will produce the same exposure (program shift).

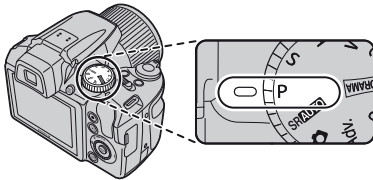

If the subject is outside the metering range of the camera, the shutter speed and aperture displays will show "---". Press the shutter button halfway to measure exposure again.

Program Shift

Rotate the command dial to choose the desired combination of shutter speed and aperture. The default values can be restored by raising the flash or turning the camera off. Program shift is not available when the flash is raised.



S: SHUTTER PRIORITY AE

Choose the shutter speed using the command dial, while the camera adjusts aperture for optimal exposure.

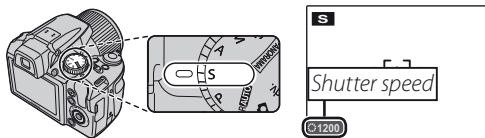

- If the correct exposure can not be achieved at the selected shutter speed, aperture will be displayed in red. Adjust shutter speed until the correct exposure is achieved. If the subject is outside the metering range of the camera, the aperture display will show "F---". Press the shutter button halfway to measure exposure again.
- The shutter speed is restricted depending on the ISO setting.

A: APERTURE PRIORITY AE

Choose the aperture using the command dial, while the camera adjusts shutter speed for optimal exposure.

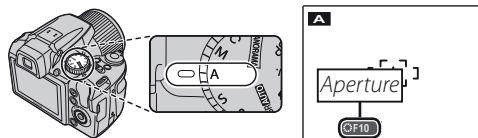

- If the correct exposure can not be achieved at the selected aperture, shutter speed will be displayed in red. Adjust aperture until the correct exposure is achieved. If the subject is outside the metering range of the camera, the shutter speed display will show "----". Press the shutter button halfway to measure exposure again.

M: MANUAL

In this mode, you choose both shutter speed and aperture. If desired, exposure can be altered from the value suggested by the camera.

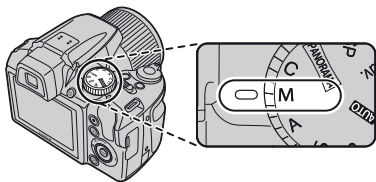

Press the  button to choose between shutter speed and aperture and rotate the command dial to adjust the selected setting.

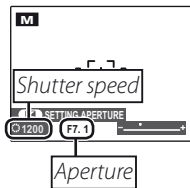

- Noise in the form of randomly-spaced bright pixels may occur in long exposures.
- The shutter speed is restricted depending on the ISO setting.

The Exposure Indicator









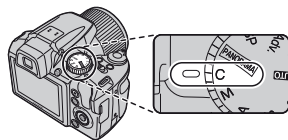







The amount the picture will be under- or over-exposed at current settings is shown by the exposure indicator.



C: CUSTOM MODE

In **P**, **S**, **A** and **M** modes, the  **CUSTOM SET** option in the shooting menu (📖 77) can be used to save current camera and menu settings. These settings are recalled whenever the mode dial is rotated to **C** (custom mode).



Menu/setting	Settings saved
Shooting menu	 ISO,  IMAGE SIZE,  FINEPIX COLOR,  IMAGE QUALITY,  PHOTOMETRY,  WHITE BALANCE,  AF MODE,  FLASH,  AE BKT EV STEPS,  FACE DETECTION,  INSTANT ZOOM
Setup menu	 IMAGE DISP,  IS MODE,  AF ILLUMINATOR,  EVF/LCD MODE,  INTELLIGENT DIGITAL ZOOM,  ZOOM SIDE ZOOM LEVER
Other	Shooting mode (P , S , A , or M), continuous shooting mode, macro mode, exposure compensation, flash mode, shutter speed, aperture, indicators/best framing

Intelligent Face Detection

Intelligent Face Detection allows the camera to automatically detect human faces and set focus and exposure for a face anywhere in the frame for shots that emphasize portrait subjects. Choose for group portraits (in horizontal or vertical orientations) to prevent the camera from focusing on the background.

1 Turn Intelligent Face Detection on.

To use Intelligent Face Detection, press **MENU/OK** to display the shooting menu and select **ON** for **FACE DETECTION**.

2 Frame the picture.

If a face is detected, it will be indicated by a green border. If there is more than one face in the frame, the camera will select the face closest to the center; other faces are indicated by white borders.



Green border

3 Focus.

Press the shutter button halfway to set focus and exposure for the subject in the green border.



If no face is detected when the shutter button is pressed halfway (111), the camera will focus on the subject at the center of the display and red-eye will not be removed.

4 Shoot.

Press the shutter button all the way down to shoot.



If the subject moves as the shutter button is pressed, their face may not be in the area indicated by the green border when the picture is taken. If the number of faces is large, additional time may be required for processing.

Intelligent Face Detection

Intelligent Face Detection is recommended when using the self-timer for group- or self-portraits (📖 40).



When a picture taken with Intelligent Face Detection is displayed, the camera can automatically select faces for red-eye removal (📖 90), playback zoom (📖 51), slide shows (📖 89), image search (📖 57), image disp. (📖 101), printing (📖 65), and cropping (📖 92).

Focus Lock

To compose photographs with off-center subjects:

1 Position the subject in the focus frame.



2 Focus.

Press the shutter button halfway to set focus and exposure. Focus and exposure will remain locked while the shutter button is pressed halfway (AF/AE lock).



*Press
halfway*



Repeat steps 1 and 2 as desired to refocus before taking the picture.

3 Recompose the picture.

Keeping the shutter button pressed halfway, recompose the picture.



4 Shoot.

Press the shutter-release button the rest of the way down to take the picture.



*Press the rest of
the way down*

Autofocus

Although the camera boasts a high-precision autofocus system, it may be unable to focus on the subjects listed below. If the camera is unable to focus using autofocus, use focus lock (📖 35) to focus on another subject at the same distance and then recompose the photograph.

- Very shiny subjects such as mirrors or car bodies.
- Fast-moving subjects.



- Subjects photographed through a window or other reflective object.
- Dark subjects and subjects that absorb rather than reflect light, such as hair or fur.
- Insubstantial subjects, such as smoke or flame.
- Subjects that show little contrast with the background (for example, subjects in clothing that is the same color as the background).
- Subjects positioned in front of or behind a high-contrast object that is also in the focus frame (for example, a subject photographed against a backdrop of highly contrasting elements).

The AF-Assist Illuminator

If the subject is poorly lit, the AF-assist illuminator will light to assist the focus operation when the shutter button is pressed halfway.



- Avoid shining the AF-assist illuminator directly into your subject's eyes.
- The camera may be unable to focus using the AF-assist illuminator in some cases. If the camera is unable to focus in macro mode (📖 37), try increasing the distance to the subject.

Macro and Super Macro Modes (Close-ups)

For close-ups, press the selector left () to choose from the macro options shown below.

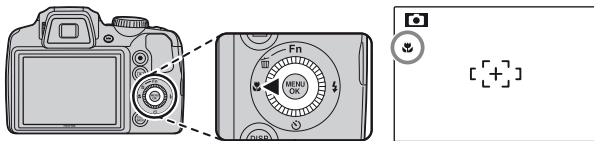

Choose from  (macro mode),
 (super macro mode), or
OFF (macro mode off)

When macro mode is in effect, the camera focuses on subjects near the center of the frame. Use the zoom control to compose pictures. In super macro mode, optical zoom can not be adjusted and the flash can not be used.



- Use of a tripod is recommended to prevent blur caused by camera shake.
- Flash compensation may be required when using the flash ( 83).
- Using the flash at close range may cast a lens shadow. Zoom a little or have more distance from the subject.

⚡ Using the Flash (Intelligent Flash)

When the flash is used, the camera's *Intelligent Flash* system instantly analyzes the scene based on such factors as the brightness of the subject, its position in the frame, and its distance from the camera. Flash output and sensitivity are adjusted to ensure that the main subject is correctly exposed while preserving the effects of ambient background lighting, even in dimly-lit indoor scenes. Use the flash when lighting is poor, for example when shooting at night or indoors under low light.

1 Raise the flash.

Press the flash pop-up button to raise the flash.

● Turning the Flash Off

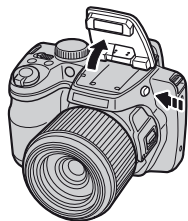

Lower the flash where flash photography is prohibited or to capture natural lighting under dim light. At slow shutter speeds,  will be displayed to warn that pictures may be blurred; use of a tripod is recommended.



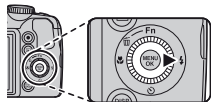

2 Choose a flash mode.

Press the selector right () . The flash mode changes each time the selector is pressed.



Mode	Description
 (AUTO FLASH)	The flash fires when required. Recommended in most situations.
 (FORCED FLASH)	The flash fires whenever a picture is taken. Use for backlit subjects or for natural coloration when shooting in bright light.
 (SLOW SYNCHRO)	Capture both the main subject and the background under low light (note that brightly lit scenes may be overexposed).

3 Focus.

Press the shutter button halfway to focus. If the flash will fire,  will be displayed when the shutter button is pressed halfway. At slow shutter speeds,  will appear in the display to warn that pictures may be blurred; use of a tripod is recommended.



4 Shoot.

Press the shutter button the rest of the way down to shoot.







The flash may fire several times with each shot. Do not move the camera until shooting is complete.



The peripheral part of an image may be dark when using the flash.

Red-Eye Removal

When Intelligent Face Detection is active (📖 33), and **ON** is selected for  **RED EYE REMOVAL** in the setup menu (📖 96), red-eye removal is available in , , and .

Red-eye removal minimizes “*red-eye*” caused when light from the flash is reflected from the subject’s retinas as shown in the illustration at right.



🕒 Using the Self-Timer

To use the self-timer, press the selector down (🕒) and choose from the following options:

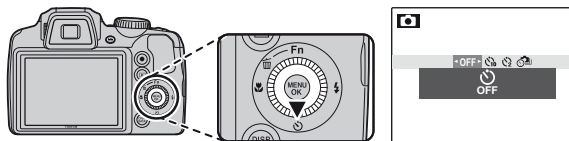

Option	Description
🕒 (OFF)	Self-timer off.
🕒 (10 SEC)	The shutter is released ten seconds after the shutter button is pressed. Use for self-portraits. The self-timer lamp on the front of the camera lights when the timer starts and begins to blink shortly before the photo is taken.
🕒 (2 SEC)	The shutter is released two seconds after the shutter button is pressed. Use to reduce blur caused by the camera moving when the shutter button is pressed. The self-timer lamp will blink as the timer counts down.
🕒 (INTERVAL SHOOTING)	Shoots photos automatically at fixed intervals.

👤 Intelligent Face Detection





Because it ensures that the faces of portrait subjects will be in focus, Intelligent Face Detection (📖 33) is recommended when using the self-timer for group portraits or self-portraits. To use the self-timer with Intelligent Face Detection, select 🕒 10 SEC or 🕒 2 SEC in the self-timer menu and then press the shutter button all the way down to start the timer. The camera will detect faces while the timer is counting down and adjust focus and exposure immediately before the shutter is released. Be careful not to move until the picture has been recorded.





The self-timer turns off automatically when the picture is taken, a different shooting mode is selected, playback mode is selected, or the camera is turned off.

Interval shooting

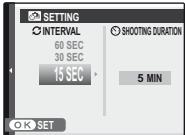
You can automatically shoot at fixed intervals.

1. Press  (▼), and then select  **INTERVAL SHOOTING**. 
2. Press **MENU/OK** to display the Interval Shooting settings screen. 
3. Set the interval and the shooting duration. Select the items by pressing ◀ or ▶, and then set the time by pressing ▲ or ▼.
INTERVAL:
 Set the interval time.
SHOOTING DURATION:
 Set the time to stop shooting. 
4. Press **MENU/OK**.
Interval shooting is set.
5. **Focus and shoot.**
Press the shutter button the rest of the way down to start interval shooting. A photo is automatically taken at the interval time, and interval shooting finishes when the camera reaches the set shooting duration time.



- If you press the shutter button before shooting ends, interval shooting stops.
 - The LCD monitor turns off and the indicator lamp flashes during interval shooting. The LCD monitor turns on three seconds before shooting starts.
 - Only the first frame is displayed when playing back photos taken by interval shooting (📖 51).
 - Continuous shooting mode is not available in interval shooting.
-  Interval shooting may end suddenly if the batteries run out. Check the amount of batteries remaining.
- Interval shooting may end suddenly if there is not enough free space on the memory card. Check the amount of free space on the memory card.
 - Depending on shooting settings or status, settings may not be applied or interval shooting may not be possible.
 - You can only use the **ON/OFF** switch, mode dial,  button, **DISP/BACK** button, and shutter button during interval shooting.

INSTANT ZOOM



In instant zoom, the area surrounding the frame is visible in the display. Use to frame erratically moving subjects such as children, pets, and athletes at sporting events.

- 1 Position the subject in the focus frame.**
Use the zoom control to frame the subject in the center of the display.

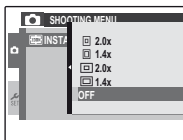

- 2 Select  INSTANT ZOOM in the shooting menu (page 75).**
An Instant Zoom setting screen is displayed.



- 3 Select a framed area to enlarge by pressing  or , and then press the MENU/OK button.**

The frame is displayed as shown at right.

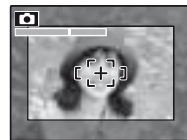

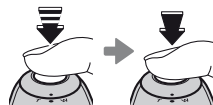

- 4 Focus and shoot.**
The framed area will be enlarged to create a full-sized picture.

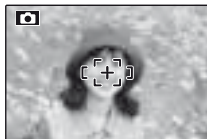

■ INTELLIGENT DIGITAL ZOOM

- 1 Enable digital zoom.
Select **ON** for the  **INTELLIGENT DIGITAL ZOOM** option in the setup menu (📖 96).
- 2 Choose a subject.
Frame the subject in the center of the display using intelligent digital zoom.



- 3 Select  **INSTANT ZOOM** in the shooting menu (📖 75).
An Instant Zoom setting screen is displayed.

- 4 Select a framed area to enlarge by pressing **▲** or **▼**, and then press the **MENU/OK** button.

The camera will zoom to the maximum optical zoom position with the area that will be recorded using intelligent digital zoom indicated by a frame at the center of the display.

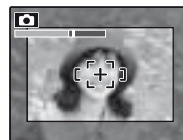

5 Frame the picture.

Use the zoom control to choose the area that will be included in the final photograph.

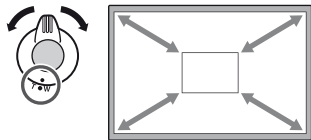

6 Focus and shoot.

The framed area will be enlarged to create a full-sized picture.

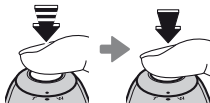

Intelligent Face Detection

Intelligent Face Detection will not detect faces outside the selected frame.



- Pictures taken using the instant zoom are lower quality than pictures taken using normal zoom.
- Only horizontal (landscape-orientation) framing is available in continuous shooting mode.

The Fn Button

The role played by the **Fn** button can be selected using the **Fn Fn BUTTON** option in the setup menu (📖 98).

The following options are available:

ISO (📖 78)/**IMAGE SIZE** (📖 78)/**IMAGE QUALITY** (📖 79)/**WHITE BALANCE** (📖 80)/**FINEPIX COLOR** (📖 80)/**PHOTOMETRY** (📖 81)/**AF MODE** (📖 82)/**FACE DETECTION** (📖 33)/ **INSTANT ZOOM** (📖 42)/**MOVIE MODE** (📖 77)/**WIRELESS COMMUNICATION** (📖 59)(S9900W Series Only)



The **Fn Fn BUTTON** menu can also be displayed by pressing and holding the **Fn** button.

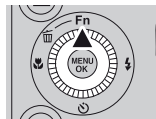

Fn button

Continuous Shooting (Burst Mode)

Capture motion or automatically vary selected settings over a series of pictures.

Press the  button and choose from the following options:

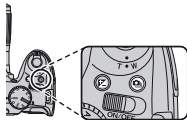

OFF: OFF

:  CONTINUOUS

:  CONTINUOUS

: BEST FRAME CAPTURE

:  CONTINUOUS

:  CONTINUOUS

:  CONTINUOUS

: AE BKT



- Focus and exposure are determined by the first frame in each series. The flash turns off automatically; the previously-selected flash mode is restored when continuous shooting is turned off.
- Frame rate varies with shutter speed, shooting conditions, and the number of pictures in each burst.
- The number of pictures that can be taken in a single burst varies with the scene and camera settings. The number of pictures that can be recorded depends on the memory available.

■  **CONTINUOUS** /  **CONTINUOUS** /  **CONTINUOUS** /  **CONTINUOUS** /  **CONTINUOUS**

The camera takes photographs while the shutter button is pressed.

■ **BEST FRAME CAPTURE**

The camera takes a series of pictures, starting before and ending after the shutter button is pressed. To choose the frame rate and number of shots:

- 1 Press the selector right when the camera is in shooting mode.
- 2 Highlight the current frame rate and press the selector right, then press selector up or down to choose a new value and press **MENU/OK** to select.



Some frame rates may reduce the number of shots available in Step 3.

- 3 Highlight the number of shots and press the selector right. Press the selector up or down to choose the number of shots in each burst and left or right to choose their distribution (the number on the left is taken *before* and the number on the right *after* the shutter button is pressed). Press **MENU/OK** when settings are complete.

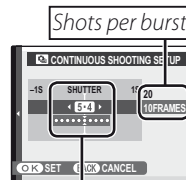

Distribution



- 4 Press **DISP/BACK** to return to shooting mode.



5 Take photographs. The camera begins recording while the shutter button is pressed halfway, and completes the burst when the shutter button is pressed all the way down. The illustration shows a burst of eight shots, three before the shutter button is pressed and four after.

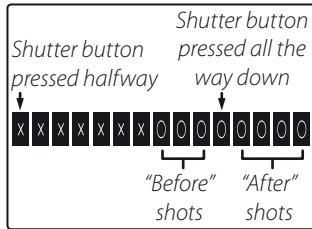

- If the shutter button is pressed all the way down before the number of frames selected for the "before" portion is recorded, the remaining frames will be taken after the shutter button is pressed all the way down.
- If the shutter button is pressed halfway for an extended period, the camera may record the burst before the shutter button is pressed all the way down.

AE BKT

Each time the shutter button is pressed, the camera takes three shots: one using the metered value for exposure, the second overexposed by the amount selected for **AE BKT EV STEPS** in the shooting menu (83), and the third underexposed by the same amount (the camera may not be able to use the selected bracketing increment if the amount of over- or under- exposure exceeds the limits of the exposure metering system).

Exposure Compensation

Use exposure compensation when photographing very bright, very dark, or high-contrast subjects.

- 1** Press the  button.
The exposure indicator will be displayed.

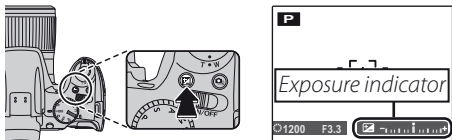

- 2** Choose a value.
Rotate the command dial. The effect is visible in the display.

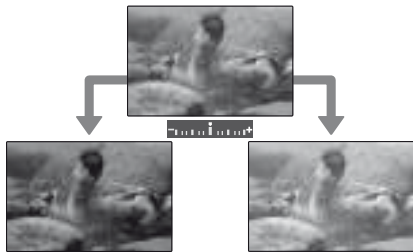

Choose negative values
to reduce exposure
("−" sign turns yellow)

Choose positive values to
increase exposure
("+ sign turns yellow)

- 3** Return to shooting mode.
Press the  button to return to shooting mode.
- 4** Take pictures.



A  icon and exposure indicator are displayed at settings other than ± 0 . Exposure compensation is not reset when the camera is turned off; to restore normal exposure control, choose a value of ± 0 .

 **Choosing an Exposure Compensation Value**

- **Backlit subjects:** choose values from $+\frac{2}{3}$ EV to $+1\frac{2}{3}$ EV

- **Highly reflective subjects or very bright scenes** (e.g., snowfields): +1 EV

- **Scenes that are mostly sky:** +1 EV
- **Spotlit subjects** (particularly if photographed against dark backgrounds): $-\frac{2}{3}$ EV
- **Subjects with low reflectivity** (pine trees or dark-colored foliage): $-\frac{2}{3}$ EV



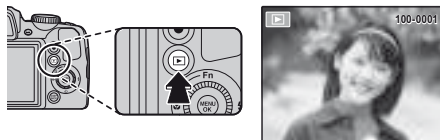

Playback Options

To view the most recent picture in the monitor, press the  button.



Press the selector right to view pictures in the order recorded, left to view pictures in reverse order. Keep the selector pressed to scroll rapidly to the desired frame.



 Pictures taken using other cameras are indicated by a  ("gift image") icon during playback.

Continuous Shooting

In the case of pictures taken in continuous shooting mode, only the first frame of each series will be displayed. Press the selector down to view the other pictures in the series.

 Pictures taken in continuous shooting mode have file names that start with "S".
(e.g. S0010001.JPG)

Playback Zoom

Select **T** to zoom in on pictures displayed in single-frame playback; select **W** to zoom out. When the picture is zoomed in, the selector can be used to view areas of the image not currently visible in the display.

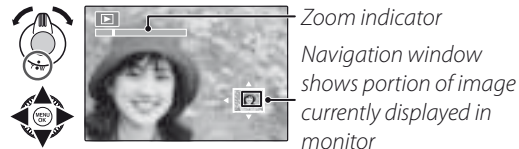

Press **DISP/BACK** to exit zoom.

 The maximum zoom ratio varies with image size. Playback zoom is not available with copies resized or cropped to a size of **640** or smaller.

● Intelligent Face Detection

Pictures taken with Intelligent Face Detection (📖 33) are indicated by a 👤 icon. Press the ▼ button to zoom in on the subject selected with Intelligent Face Detection. You can then use the zoom control to zoom in and out.



★ Favorites: Rating Pictures

To rate the picture currently displayed in full-frame playback, press **DISP/BACK** and press the selector up and down to select from zero to five stars.

📖 Favorites

Ratings can be used for image search (📖 57).

Multi-Frame Playback

To change the number of images displayed during playback, select **W**.

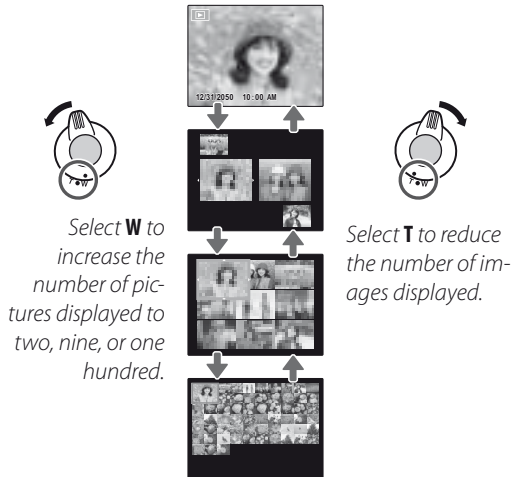

Use the selector to highlight images and press **MENU/OK** to view the highlighted image full frame. In the nine- and hundred-frame displays, press the selector up or down to view more pictures.

Two-Frame Display

Two-frame display can be used to compare pictures taken in  mode.



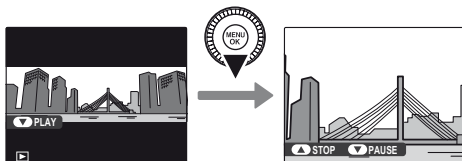

Viewing Panoramas

If you press the selector down when a panorama is displayed full frame, the camera will play back the picture from left to right or from bottom to top.



The following operations can be performed during playback:

Operation	Button	Description
Start/pause playback		Press the selector down to start playback. Press again to pause.
End playback		Press the selector up to end playback.

←
Once displayed in full-frame playback, panoramas can be zoomed in or out using the zoom lever.

PhotoBook Assist

Create books from your favorite photos.

Creating a PhotoBook

1 Select  **PHOTOBOOK ASSIST** in the playback menu.

2 Highlight **NEW BOOK**.



3 Press **MENU/OK** to display the new book dialog.



4 Choose pictures for the new book.

- **SELECT FROM ALL:** Choose from all the pictures available.
- **SELECT BY IMAGE SEARCH:** Choose from pictures matching selected search conditions (p. 57).



Neither photographs **640** or smaller nor movies can be selected for photobooks.

5 Scroll through the images and press the selector up to select or deselect the current image for inclusion in the book. To display the current image on the cover, press the selector down.



The first picture selected automatically becomes the cover image. Press the selector down to select a different picture for the cover.

6 Press **MENU/OK** to exit when the book is complete.



7 Highlight **COMPLETE PHOTOBOOK**.

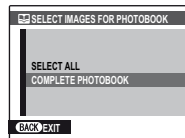

Choose **SELECT ALL** to select all photos, or all photos matching the specified search conditions, for the book.

8 Press **MENU/OK**. The new book will be added to the list in the photobook assist menu.



- Photobooks can contain up to 300 pictures.
- Books that contain no photos are automatically deleted.

PhotoBooks

Photobooks can be copied to a computer using the supplied MyFinePix Studio software.

Viewing PhotoBooks

Highlight a book in the photobook assist menu and press **MENU/OK** to display the book, then press the selector left and right to scroll through the pictures. Press **DISP/BACK** to return to the photobook assist menu.

Editing and Deleting PhotoBooks





- 1** Display the photobook and press **MENU/OK** to view book edit options. 
- 2** Choose from the following options:
 - **EDIT:** Edit the book as described in “Creating a PhotoBook” on page 55.
 - **ERASE:** Delete the current photobook.
- 3** Follow the on-screen instructions.

Image Search

Search for pictures by date, subject, scene, file type, and rating.



- 1 Select  **IMAGE SEARCH** in the playback menu.
- 2 Highlight one of the following options and press **MENU/OK**:



Option	Description
BY DATE	Find all pictures taken on a selected date.
BY FACE	Find all pictures containing faces.
BY ★ FAVORITES	Find all pictures with a specified rating ( 52).
BY SCENE	Find all pictures that match a selected scene.
BY TYPE OF DATA	Find all still pictures or all movies.
BY UPLOAD MARK	Find all pictures selected for upload to a specified destination ( 87).

- 3 Select a search condition. Only pictures that match the search condition will be displayed. To delete or protect selected pictures or to view the selected pictures in a slide show, press **MENU/OK** and choose from the following options:





Option	See page
 ERASE	58
 PROTECT	91
 SLIDE SHOW	89

- 4 To end the search, select **EXIT SEARCH**.

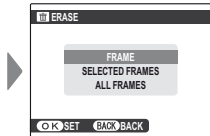

Deleting Pictures

To delete individual pictures, multiple selected pictures, or all pictures, press the selector up () and choose from the options below. *Note that deleted pictures can not be recovered. Copy important pictures to a computer or other storage device before proceeding.*



Option	Description
FRAME	Press the selector left or right to scroll through pictures and press MENU/OK to delete the current picture (a confirmation dialog is not displayed).
SELECTED FRAMES	Highlight pictures and press MENU/OK to select or deselect (pictures that are protected or in a print order are shown by ). When the operation is complete, press DISP/BACK to display a confirmation dialog, then highlight OK and press MENU/OK to delete the selected pictures.
ALL FRAMES	A confirmation dialog will be displayed; highlight OK and press MENU/OK to delete all unprotected pictures. Pressing DISP/BACK cancels deletion; note that any pictures deleted before the button was pressed can not be recovered.



- Protected pictures can not be deleted. Remove protection from any pictures you wish to delete ( 91).
- Pictures can also be deleted by  **ERASE** from playback menu.
- If a message appears stating that the selected images are part of a DPOF print order, press **MENU/OK** to delete the pictures.

Using Wireless Networks (S9900W Series Only)

You can connect the camera with a smartphone or a PC. For information on using wireless networks, visit <http://fujifilm-dsc.com/wifi/>.

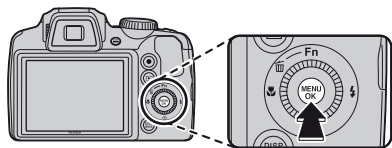

Connecting with smartphones

You can connect to smartphones via a wireless network by using  **WIRELESS COMMUNICATION** from the shooting menu or playback menu.

You can use the following features when the camera is connected to smartphones.

- Taking pictures using smartphones
- Uploading pictures to smartphones
- Browsing and downloading the pictures on the camera using smartphones
- Downloading location data from smartphones

Before proceeding, download the free FUJIFILM Camera Remote app and install it on your smartphone.

You can also use the wireless communication option in the shooting mode when **WIRELESS COMMUNICATION** is assigned in the **Fn** menu.

Saving Pictures to a Computer

Select  **PC AUTO SAVE** from the playback menu to save pictures to a computer over a wireless network. Before proceeding, install the free FUJIFILM PC AutoSave application to the destination computer and adjust settings as desired.

Recording Movies

Press **REC** to shoot a movie. During recording, the following indicators will be displayed and sound will be recorded via the built-in microphone (be careful not to cover the microphone during recording).

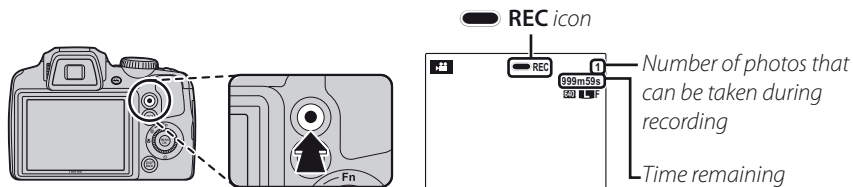

To end recording, press the **REC** button again. Recording ends automatically when the movie reaches maximum length or memory is full.



- If the subject is poorly lit, the AF-assist lamp may light to assist the focus operation.
To turn the AF-assist lamp off, select **OFF** for **AF² AF ILLUMINATOR** in the setup menu (📖 98).
- Exposure and white balance are adjusted automatically throughout recording. The color and brightness of the image may vary from that displayed before recording begins.
- Sounds made by the camera may be recorded.
- **ADVANCED FILTER** options are available when shooting movies (📖 23).



Taking Photographs during Recording

Press the shutter button to take a photograph during recording.



- Image size is determined by the option selected for  **MOVIE MODE**.
- The photo is saved separately from the movie and does not appear as part of the movie.



- Photos can not be taken while a high-speed movie is being recorded.
- The number of photos that can be taken is limited.
- When using  **ADVANCED FILTER**, some effects can not be applied to photos ( 23).

DIGITAL IMAGE STABILIZER







You can correct camera vibrations that occur when shooting movies to shoot images with only minor vibration—using the  **DIGITAL IMAGE STABILIZER** in the setup menu.



- The indicator lamp lights while movies are being recorded. Do not open the battery chamber during shooting or while the indicator lamp is lit. Failure to observe this precaution could prevent the movie from being played back.
- Vertical or horizontal streaks may appear in movies containing very bright subjects. This is normal and does not indicate a malfunction.
- The temperature of the camera may rise if it is used to record movies for an extended period or if the ambient temperature is high. This is normal and does not indicate a malfunction.
- Optical zoom can not be adjusted when shooting movies in super macro mode ( 37).

Movie Frame Size









Before recording, select a frame size using the  **MOVIE MODE** option in the shooting menu ( 77).

Option	Description
 1920 × 1080	Full HD (High Definition).
 1280 × 720	High Definition.
 640 × 480	Standard definition.
 640 × 480 (120fps)	High speed movie. Sound is not recorded, and focus, exposure, and white balance are not adjusted automatically. Zoom can not be adjusted.
 320 × 240 (240fps)	
 320 × 120 (480fps)	



When movies are recorded to internal memory, the default value is set to  **640×480**.

Automatic Scene Selection

In  mode, the camera selects the scene according to shooting conditions and the type of subject:  (portraits),  (poorly-lit landscapes),  (poorly-lit portraits),  (landscapes),  (close-ups),  (backlit portraits), or  (other subjects).



Scene icon

▶ Viewing Movies

During playback (📖 51), movies are displayed in the monitor as shown at right. The following operations can be performed while a movie is displayed:

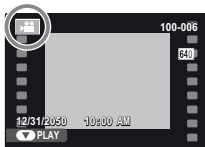

Operation	Description
Start/pause playback	Press the selector down to start playback. Press again to pause.
End playback/delete	Press the selector up to end playback. If playback is not in progress, pressing the selector up will delete the current movie.
Advance/rewind	Press the selector left or right to adjust playback speed. Speed is shown by the number of arrows (▶ or ◀).
Adjust volume	Press MENU/OK to pause playback and display volume controls. Press the selector up or down to adjust the volume; press MENU/OK again to set the volume.

Progress is shown in the monitor during playback.

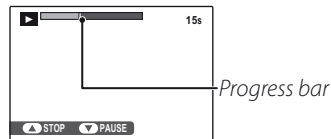

📖 Viewing Movies on a Computer

Copy movies to the computer before viewing.



Do not cover the speaker during playback.

Viewing Pictures on TV

Connecting the Camera to High Definition (HD) TVs

When an HDMI cable (available from third-party suppliers) is connected, pictures and sound are played back on the TV.

- 1 Turn the camera off and connect an HDMI cable available from third party suppliers.



- The USB cable can not be used while an HDMI cable is connected.
- Use an HDMI cable no more than 1.5 m (4.9 ft.) long.

- 2 Tune the television to the video or HDMI input channel. See the documentation supplied with the television for details.

- 3 Press the  button for about a second to turn the camera on. The camera monitor turns off and pictures and movies are played back on the TV. Note that the camera volume controls have no effect on sounds played on the TV; use the television volume controls to adjust the volume.



When connecting the cable, be sure the connectors are fully inserted.

Printing Pictures via USB

If the printer supports PictBridge, the camera can be connected directly to the printer and pictures can be printed without first being copied to a computer. Note that depending on the printer, not all the functions described below may be supported.



Connecting the Camera

- 1 Connect the supplied USB cable as shown and turn the printer on.

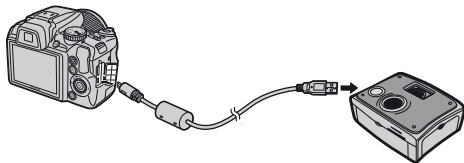

- 2 Press the button for about a second to turn the camera on. **USB** will be displayed in the monitor, followed by the PictBridge display shown below at right.

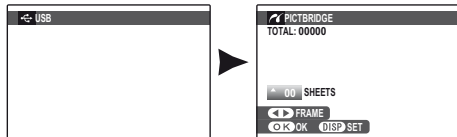

Printing Selected Pictures

- 1 Press the selector left or right to display a picture you wish to print.
- 2 Press the selector up or down to choose the number of copies (up to 99).
- 3 Repeat steps 1–2 to select additional pictures. Press **MENU/OK** to display a confirmation dialog when settings are complete.

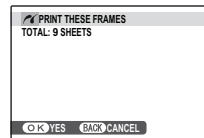

- 4 Press **MENU/OK** to start printing.





Printing the Date of Recording

To print the date of recording on pictures, press **DISP/BACK** in steps 1–2 to display the PictBridge menu (see “Printing the DPOF Print Order,” below). Press the selector up or down to highlight **PRINT WITH DATE**  and press **MENU/OK** to return to the PictBridge display (to print pictures without the date of recording, select **PRINT WITHOUT DATE**).



If no pictures are selected when the **MENU/OK** button is pressed, the camera will print one copy of the current picture.

Printing the DPOF Print Order

To print the print order created with  **PRINT ORDER (DPOF)** in the playback menu ( 68).

- 1 In the PictBridge display, press **DISP/BACK** to open the PictBridge menu.

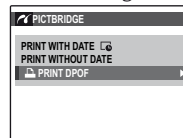

- 2 Press the selector up or down to highlight  **PRINT DPOF**.



- 3 Press **MENU/OK** to display a confirmation dialog.

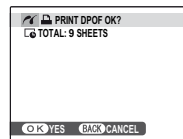



4 Press **MENU/OK** to start printing.

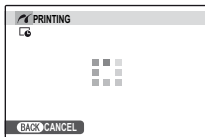

● **During Printing**

The message shown at right is displayed during printing. Press **DISP/BACK** to cancel before all pictures are printed (depending on the printer, printing may end before the current picture has printed).



If printing is interrupted, press  to turn the camera off and then on again.

● **Disconnecting the Camera**

Confirm that "PRINTING" is not displayed in the monitor and turn the camera off. Disconnect the USB cable.



- Print pictures from a memory card that has been formatted in the camera.
- If the printer does not support date printing, the **PRINT WITH DATE**  option will not be available in the PictBridge menu and the date will not be printed on the pictures in the DPOF print order.
- When pictures are printed via direct USB connection, page size, print quality, and border selections are made using the printer.

Creating a DPOF Print Order



The  **PRINT ORDER (DPOF)** option in the playback menu can be used to create a digital “print order” for PictBridge-compatible printers (📖 106) or devices that support DPOF.

DPOF

DPOF (Digital Print Order Format) is standard that allows pictures to be printed from “print orders” stored on a memory card. The information in the order includes the pictures to be printed, date imprint, and the number of copies of each picture.



■ **WITH DATE** / **WITHOUT DATE**

To modify the DPOF print order, select  **PRINT ORDER (DPOF)** in the playback menu and press the selector up or down to highlight **WITH DATE**  or **WITHOUT DATE**.

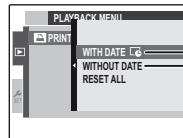

WITH DATE : *Print date of recording on pictures.*

WITHOUT DATE: *Print pictures without date.*

Press **MENU/OK** and follow the steps below.

- 1 Press the selector left or right to display a picture you wish to include in or remove from the print order.



- 2 Press the selector up or down to choose the number of copies (up to 99). To remove a picture from the order, press the selector down until the number of copies is 0.

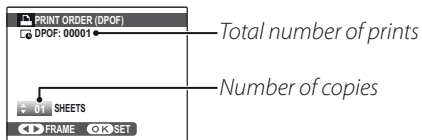

Intelligent Face Detection

If the current picture was created with Intelligent Face Detection, pressing ▼ sets the number of copies to the number of faces detected.



When pictures are printed via direct USB connection, page size, print quality, and border selections are made using the printer.

- 3 Repeat steps 1–2 to complete the print order. Press **MENU/OK** to save the print order when settings are complete, or **DISP/BACK** to exit without changing the print order.
- 4 The total number of prints is displayed in the monitor. Press **MENU/OK** to exit.



The pictures in the current print order are indicated by a  icon during playback.





- Print orders can contain a maximum of 999 pictures.
- If a memory card is inserted containing a print order created by another camera, the message shown at right will be displayed. Pressing **MENU/OK** cancels the print order; a new print order must be created as described above.

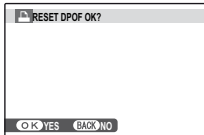

■ **RESET ALL**

To cancel the current print order, select **RESET ALL** in the  **PRINT ORDER (DPOF)** menu. The confirmation shown at right will be displayed; press **MENU/OK** to remove all pictures from the order.

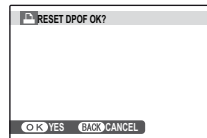

Viewing Pictures on a Computer

The supplied software can be used to copy pictures to a computer, where they can be stored, viewed, organized, and printed. Before proceeding, install the software as described below. *Do not connect the camera to the computer until installation is complete.*

Windows: Installing MyFinePix Studio

1 Confirm that the computer meets the following system requirements:

	Windows 8.1/Windows 8/Windows 7 (SP 1)/Windows Vista (SP 2)¹
CPU	3 GHz Pentium 4 or better (2.4 GHz Core 2 Duo or better) ²
RAM	1 GB or more
Free disk space	2 GB or more
GPU	Supports DirectX 9 or later (recommended)
Video	1,024 × 768 pixels or more with 24-bit color or better
Other	<ul style="list-style-type: none">• Built-in USB port recommended. Operation is not guaranteed with other USB ports.• Internet connection (broadband recommended) required to install .NET Framework (if necessary), to use auto update feature, and when performing such tasks as sharing pictures on-line or via e-mail.• Installation of .Net Framework 3.5 SP1 required to use upload picture feature and MapViewer.

¹ Other versions of Windows are not supported. Only pre-installed operating systems are supported; operation is not guaranteed on home-built computers or computers that have been upgraded from earlier versions of Windows.

² Recommended when displaying HD movies.

- 2 Start the computer. Log in to an account with administrator privileges before proceeding.
- 3 Exit any applications that may be running and insert the installer CD in a CD-ROM drive.

Windows 8.1/Windows 8/Windows 7/Windows Vista

If an AutoPlay dialog is displayed, click **SETUP.EXE**. A “User Account Control” dialog will then be displayed; click **Yes** (Windows 8.1/Windows 8/Windows 7) or **Allow** (Windows Vista).

The installer will start automatically; click **Install MyFinePix Studio** and follow the on-screen instructions to install MyFinePix Studio.

If the Installer Does Not Start Automatically (Windows 7/Windows Vista)

If the installer does not start automatically, select **Computer** or **My Computer** from the Start menu, then double-click the **FINEPIX** CD icon to open the FINEPIX CD window and double-click **setup** or **SETUP.EXE**.

If the Installer Does Not Start Automatically (Windows 8.1/Windows 8)

- 1 Select **Desktop** on the Start screen.
- 2 Select **File Explorer** on the taskbar.
- 3 Select **This PC** (Windows 8.1) or **Computer** (Windows 8) in the navigation pane.
- 4 Double-click the drive icon inserting the **FINEPIX** CD and follow the on-screen instructions to install.

- 4 If prompted to install Windows Media Player or DirectX, follow the on-screen instructions to complete installation.
- 5 Remove the installer CD from the CD-ROM drive when installation is complete. Store the installer CD in a dry location out of direct sunlight in case you need to re-install the software. The version number is printed at the top of the CD label for reference when updating the software or contacting customer support.

Installation is now complete. Proceed to “Connecting the Camera” on page 73.

Importing pictures or movies to Mac (Macintosh)

Use a standard application in Mac OS such as **Image Capture** to import pictures or movies to Mac.

Connecting the Camera

- 1 If the pictures you wish to copy are stored on a memory card, insert the card into the camera (see 11).





Windows users may require the Windows CD when starting the software for the first time.

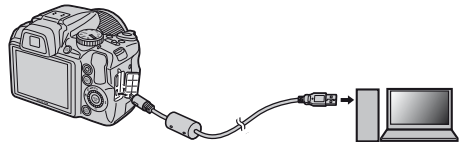

Loss of power during transfer could result in loss of data or damage to the memory card. Charge the battery before connecting the camera.

- 2 Turn the camera off and connect the supplied USB cable as shown, making sure the connectors are fully inserted. Connect the camera directly to the computer; do not use a USB hub or keyboard.



- 3 Press the  button for about a second to turn the camera on. After starting MyFinePix Studio, follow the on-screen instructions to copy pictures to the computer. To exit without copying pictures, click **Cancel**.

For more information on using the supplied software, start the application and select the appropriate option from the **Help** menu.



- If a memory card containing a large number of images is inserted, there may be a delay before the software starts and you may be unable to import or save images. Use a memory card reader to transfer pictures.
- Make sure that the computer does not display a message stating that copying is in progress and that the indicator lamp is out before turning the camera off or disconnecting the USB cable (if the number of images copied is very large, the indicator lamp may remain lit after the message has cleared from the computer display). Failure to observe this precaution could result in loss of data or damage to the memory card.
- Disconnect the camera before inserting or removing memory cards.
- In some cases, it may not be possible to access pictures saved to a network server using the supplied software in the same way as on a standalone computer.
- The user bears all applicable fees charged by the phone company or Internet service provider when using services that require an Internet connection.

Disconnecting the Camera

After confirming that the indicator lamp is out, follow the on-screen instructions to turn the camera off and disconnect the USB cable.

Uninstalling the Supplied Software

Only uninstall the supplied software when it is no longer required or before beginning reinstallation. After quitting the software and disconnecting the camera, open the control panel and use “Programs and Features” to uninstall MyFinePix Studio. Under Windows, one or more confirmation dialogs may be displayed; read the contents carefully before clicking **OK**.

Using the Menu: Shooting Mode

Using the Shooting Menu

1 Press **MENU/OK** to display the shooting menu.



2 Press the selector up or down to highlight the desired menu item.



3 Press the selector right to display options for the highlighted item.



4 Press the selector up or down to highlight the desired option.























5 Press **MENU/OK** to select the highlighted option.



























6 Press **DISP/BACK** to exit from the menu.



Shooting Menu Options

Menu item	Description	Options	Default
 SCENE POSITION	Choose a scene for SP mode (📖 26).		
 Adv. MODE	Choose an advanced shooting mode (📖 22).		
 ISO	Adjust ISO sensitivity. Choose higher values when the subject is poorly lit.	AUTO (3200) / AUTO (1600) / AUTO (800) / AUTO (400) / 12800 / 6400 / 3200 / 1600 / 800 / 400 / 200 / 100	AUTO (1600)
 IMAGE SIZE	Choose image size and aspect ratio (📖 78).	L 4:3 / L 3:2 / L 16:9 / L 1:1 / M 4:3 / M 3:2 / M 16:9 / M 1:1 / S 4:3 / S 3:2 / S 16:9 / S 1:1	L 4:3
 IMAGE QUALITY	Choose image quality (📖 79).	FINE/NORMAL	NORMAL
 FINEPIX COLOR	Shoot pictures in standard or saturated color or in black-and white (📖 80).		
 WHITE BALANCE	Adjust color for different light sources (📖 80).	AUTO / 	AUTO
 INSTANT ZOOM	In instant zoom, the area surrounding the frame is visible in the display. Use to frame erratically moving subjects such as children, pets, and athletes at sporting events.	OFF / 	OFF
 FACE DETECTION	Choose whether the camera automatically detects and sets focus and exposure for human portrait subjects (📖 33).	ON / OFF	OFF
 PHOTOMETRY	Choose how the camera meters exposure (📖 81).		

Menu item	Description	Options	Default
 AF MODE	Choose how the camera selects a focus area (📖 82).	 /  /  /  /  / 	
 MOVIE AF MODE	This option controls how the camera selects the focus area for movies (📖 83).	 / 	
 MOVIE MODE	Choose a frame size for movies (📖 62).	 1920 × 1080 /  1280 × 720 /  640 × 480 /  640 × 480 /  320 × 240 /  320 × 120	 1920 × 1080
 AE BKT EV STEPS	Choose the size of the bracketing increment when  is selected in continuous shooting mode (📖 83).	$\pm\frac{1}{3}$ EV / $\pm\frac{2}{3}$ EV / ± 1 EV	$\pm\frac{1}{3}$ EV
 WIRELESS COMMUNICATION*	When connecting to smartphones, you can use the following functions: <ul style="list-style-type: none"> • Taking pictures using smartphones • Uploading pictures to smartphones • Browsing and downloading the pictures on the camera using smartphones • Downloading location data from smartphones 	—	—
 FLASH	Adjust flash brightness (📖 83).	$-\frac{2}{3}$ EV – $+\frac{2}{3}$ EV in steps of $\frac{1}{3}$ EV	0
 CUSTOM SET	Save settings for P , S , A , and M modes (📖 32).	—	—

* S9900W Series Only

For information on using wireless networks, visit <http://fujifilm-dsc.com/wifi/>.

ISO ISO

Control the camera's sensitivity to light. Higher values can be used to reduce blur when lighting is poor; note, however, that mottling may appear in pictures taken at high sensitivities. If **AUTO**, **AUTO (800)**, or **AUTO (400)** is selected, the camera will adjust sensitivity automatically in response to shooting conditions. The maximum values that will be selected by the camera at settings of **AUTO (800)** and **AUTO (400)** are 800 and 400 respectively. Settings other than **AUTO** are shown by an icon in the display.



Sensitivity is not reset when the camera is turned off or another shooting mode is selected.

IMAGE SIZE

Choose the size and aspect ratio at which still pictures are recorded. Large pictures can be printed at large sizes with no drop in quality; small pictures require less memory, allowing more pictures to be recorded.

The number of pictures that can be taken at the selected setting is shown in the display (📖 121).

Size Versus Aspect Ratio

Size

Option	Prints at sizes up to
L	34 × 25 cm (13.5 × 10 in.)
M	24 × 18 cm (9.5 × 7 in.)
S	17 × 13 cm (7 × 5 in.)

Aspect ratio

4:3: Pictures have the same proportions as the camera display.

3:2: Pictures have the same proportions as a frame of 35 mm film.

16:9: Suited for display on High Definition (HD) devices.

1:1: Pictures are square.

IMAGE QUALITY

Choose how much image files are compressed. Select **FINE** (low compression) for higher image quality, **NORMAL** (high compression) to increase the number of pictures that can be stored.



- Image size is not reset when the camera is turned off or another shooting mode is selected.
- When pictures are recorded to internal memory, the default value is set to **S 4:3**.

FINEPIX COLOR

Enhance contrast and color saturation or take pictures in black and white.

Option	Description
STANDARD	Standard contrast and saturation. Recommended in most situations.
CHROME	Vivid contrast and color. Choose for vivid shots of flowers or enhanced greens and blues in landscapes.
B&W	Take pictures in black and white.

Settings other than **STANDARD** are shown by an icon in the display.



- **FINEPIX COLOR** is not reset when the camera is turned off or another shooting mode is selected.
- The effects of **CHROME** vary from scene to scene and may be difficult to discern with some subjects. Depending on the subject, the effects of **CHROME** may not be visible in the display.

WHITE BALANCE

For natural colors, choose a setting that matches the light source.

Option	Description
AUTO	White balance adjusted automatically.
	Measure a value for white balance.
	For subjects in direct sunlight.
	For subjects in the shade.
	Use under "daylight" fluorescent lights.
	Use under "warm white" fluorescent lights.
	Use under "cool white" fluorescent lights.
	Use under incandescent lighting.

If **AUTO** does not produce the desired results (for example, when taking close-ups), select and measure a value for white balance or choose the option that matches the light source.



- At settings other than , auto white balance is used with the flash. Lower the flash (📖 38) to take pictures at other settings.
- Results vary with shooting conditions. Play pictures back after shooting to check colors in the monitor.

■ Custom White Balance

Choose  to adjust white balance for unusual lighting conditions. White balance measurement options will be displayed; frame a white object so that it fills the monitor and press the shutter button all the way down to measure white balance.

If **“COMPLETED!” is displayed**, press **MENU/OK** to set white balance to the measured value. This value can be reselected by pressing **MENU/OK** when custom white balance options are displayed.

If **“UNDER” is displayed**, raise exposure compensation ( 49) and try again.





If **“OVER” is displayed**, lower exposure compensation and try again.



To give a deliberate color cast to your photographs, measure a value for custom white balance using a colored instead of a white object.

PHOTOMETRY

Choose how the camera meters exposure when Intelligent Face Detection is off.

-  **MULTI**: Automatic scene recognition is used to adjust exposure for a wide range of shooting conditions.
-  **SPOT**: The camera meters lighting conditions at the center of the frame. Recommended when the background is much brighter or darker than the main subject. Can be used with focus lock ( 35) to meter off-center subjects.
-  **AVERAGE**: Exposure is set to the average for the entire frame. Provides consistent exposure across multiple shots with the same lighting, and is particularly effective for landscapes and portraits of subjects dressed in black or white.

AF MODE

This option controls how the camera selects the focus area when Intelligent Face Detection is off (📖 33). Regardless of the option selected, the camera will focus on the subject in the center of the monitor when macro mode is on (📖 37).

- **☐ CENTER:** The camera focuses on the subject in the center of the frame. This option can be used with focus lock (📖 35).
- **+ MULTI:** When the shutter button is pressed halfway, the camera detects high-contrast subjects near the center of the frame and selects the focus area automatically (if the focus frame is not displayed, select **☐ CENTER** and use focus lock; 📖 35).

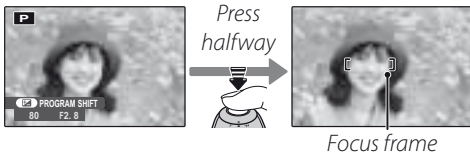

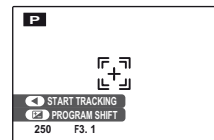
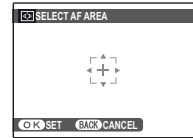

- **+ AREA:** The focus position can be chosen manually by pressing the selector up, down, left, or right and pressing **MENU/OK** when the focus brackets are in the desired position. Choose for precise focus when the camera is mounted on a tripod. Note that exposure is set for the subject in the center of the frame; to meter an off-center subject, use AF/AE lock (📖 35).
- **☐ CONTINUOUS:** The camera continually adjusts focus to reflect changes in the distance to the subject even when the shutter button is not pressed (note that this increases the drain on the battery).
- **+ TRACKING:** Position the subject in the center focus area and press the selector left to select tracking. Focus will track the subject as it moves through the frame.



MOVIE AF MODE



This option controls how the camera selects the focus area for movies.

Option	Description
 CENTER	The camera focuses on the subject in the center of the frame.
 CONTINUOUS	The camera continuously adjusts focus to reflect changes in the distance to subjects near the center of the frame.



Note that in  mode, the camera focuses continuously, increasing the drain on the battery, and that the sound of the camera focusing may be audible.

AE BKT EV STEPS

Choose the size of the exposure bracketing increment used when  (AE bracketing) is selected in continuous shooting mode ( 46).

Choose from increments of $\pm\frac{1}{3}$ EV, $\pm\frac{2}{3}$ EV, and ± 1 EV.

FLASH

Adjust flash brightness. Choose from values between $+\frac{2}{3}$ EV and $-\frac{2}{3}$ EV. The default setting is ± 0 . Note that the desired results may not be achieved depending on shooting conditions and the distance to the subject.

Using the Menus: Playback Mode

Using the Playback Menu

- 1** Press the  button to enter playback mode.
- 2** Press **MENU/OK** to display the playback menu.
- 3** Press the selector up or down to highlight the desired menu item.



















- 4** Press the selector right to display options for the highlighted item.
- 5** Press the selector up or down to highlight the desired option.
- 6** Press **MENU/OK** to select the highlighted option.



Playback Menu Options

The following options are available:

Option	Description
 WIRELESS COMMUNICATION*	When connecting to smartphones, you can use the following functions: <ul style="list-style-type: none"> • Taking pictures using smartphones • Uploading pictures to smartphones • Browsing and downloading the pictures on the camera using smartphones • Downloading location data from smartphones
 PC AUTO SAVE*	Upload pictures to a computer over a wireless network (📖 59).
 PHOTOBOOK ASSIST	Create books from your favorite photos (📖 55).
 IMAGE SEARCH	Search for pictures by date, subject, scene, file type, or rating (📖 57).
 ERASE	Delete all or selected pictures (📖 58).
 MOVIE EDIT	Edit movies (📖 86).
 MARK FOR UPLOAD	Select pictures for upload to YouTube, Facebook or MyFinePix.com using MyFinePix Studio (Windows only) (📖 87).
 SLIDE SHOW	View pictures in a slide show (📖 89).
 RED EYE REMOVAL	Create copies with reduced red eye (📖 90).
 PROTECT	Protect pictures from accidental deletion (📖 91).
 CROP	Create cropped copies of pictures (📖 92).
 RESIZE	Create small copies of pictures (📖 93).
 IMAGE ROTATE	Rotate pictures (📖 94).
 COPY	Copy pictures from internal memory to a memory card (📖 95).
 PRINT ORDER (DPOF)	Select pictures for printing on DPOF- and PictBridge-compatible devices (📖 68).
 DISP. ASPECT	Choose how High Definition (HD) devices display pictures (📖 95).

* S9900W Series Only

For information on using wireless networks, visit <http://fujifilm-dsc.com/wifi/>.

MOVIE EDIT

Edit movies.

■ **MOVIE TRIMMING**

Remove opening or ending footage to create an edited copy of the current movie.

- 1 Display the desired movie.
- 2 Select  **MOVIE EDIT** in the playback menu, then select **MOVIE TRIMMING**. To remove footage from the start of the copy, proceed to Step 3; otherwise, proceed to Step 4.
- 3 Press the selector down to begin playback and press it down again when the new opening frame is reached.
- 4 Press **MENU/OK**. To remove footage from the end of the copy, proceed to Step 5; otherwise, proceed to Step 6.
- 5 Press the selector down to begin playback and press it down again when the new closing frame is reached.
- 6 Press **MENU/OK** to save the copy.

■ **MOVIE JOIN**

Add existing footage to the end of the current movie to create an edited copy.

- 1 Display the desired movie.
- 2 Select  **MOVIE EDIT** in the playback menu, then select **MOVIE JOIN**.
- 3 Press the selector left or right to highlight a movie.
- 4 Press **MENU/OK** to add the highlighted footage to the end of the current movie and save the resulting copy, or press **DISP/BACK** to exit without creating a copy.



Both movies must have been recorded at the same frame size and frame rate.

MARK FOR UPLOAD

You can select images and movies to be queued for upload to YouTube, Facebook and MyFinePix.com. Select  **MARK FOR UPLOAD** in the playback menu.



■ Add/Remove Items in the Upload Queue

- 1 Select an upload destination.
- 2 Press **MENU/OK**.
- 3 Select items to be added to, or removed from, the upload queue.
- 4 Press **MENU/OK** to confirm.
 - Items not in the upload queue will be added to the queue when you select them and press **MENU/OK**.
 - Items in the upload queue will be removed from the queue when you select them and press **MENU/OK**.



- 5 Repeat steps 3 and 4 as necessary and add or remove items. When finished, press **DISP/BACK** to save the settings.



- **YouTube**, **Facebook** or **MyFinePix.com** is displayed to indicate items queued for upload.
- Only movies can be selected for upload to YouTube.
- Only photos can be selected for upload to MyFinePix.com.
- During playback, selected pictures are indicated by  **YouTube**,  **Facebook** or  **MyFinePix.com** icons.

■ Removing All Items From the Upload Queue

You can remove all items from the upload queue.

1 Select **RESET ALL**.

The screen for removing all items from the upload queue is displayed.



2 Select **OK**.



3 Press **MENU/OK**.

All items are removed from the upload queue.



If there are many items in the upload queue when you select to remove all items from the queue, it may take some time to remove them. To cancel, press **DISP/BACK**.

■ Upload Items

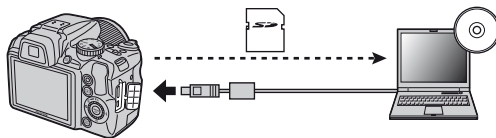

Items added to the upload queue using the camera can be easily uploaded from a computer by using the MyFinePix Studio. Install MyFinePix Studio (📖 71).



This feature is available only when using a computer running Windows.

SLIDE SHOW

View pictures in an automated slide show. Choose the type of show and press **MENU/OK** to start. Press **DISP/BACK** at any time during the show to view on-screen help. When a movie is displayed, movie playback will begin automatically, and the slide show will continue when the movie ends. The show can be ended at any time by pressing **MENU/OK**.

Option	Displayed in
NORMAL	Press selector left or right to go back or skip ahead one frame. Select FADE-IN for fade transitions between frames.
FADE-IN	
NORMAL 	As above, except that camera automatically zooms in on faces selected with Intelligent Face detection.
FADE-IN 	





The camera will not turn off automatically while a slide show is in progress.

RED EYE REMOVAL

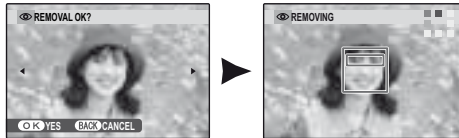
If the current picture is marked with a  icon to indicate that it was taken with Intelligent Face Detection, this option can be used to remove red-eye. The camera will analyze the image; if red-eye is detected, the image will be processed to create a copy with reduced red-eye.



- Red eye may not be removed if the camera is unable to detect a face or the face is in profile. Results may differ depending on the scene. Red eye can not be removed from pictures that have already been processed using red-eye removal or pictures created with other devices.
- The amount of time needed to process the image varies with the number of faces detected.
- Copies created with  **RED EYE REMOVAL** are indicated by a  icon during playback.

PROTECT

Protect pictures from accidental deletion. The following options are available.

■ FRAME

Protect selected pictures.

- 1 Press the selector left or right to display the desired picture.

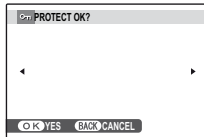

Picture not protected

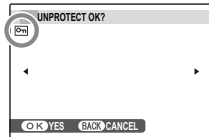

Protected picture



- 2 Press **MENU/OK** to protect the picture. If the picture is already protected, pressing **MENU/OK** will remove protection from the image.



- 3 Repeat steps 1–2 to protect additional images. Press **DISP/BACK** to exit when the operation is complete.



■ SET ALL

Press **MENU/OK** to protect all pictures, or press **DISP/BACK** to exit without changing picture status.

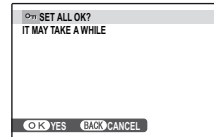

■ RESET ALL

Press **MENU/OK** to remove protection from all pictures, or press **DISP/BACK** to exit without changing picture status.

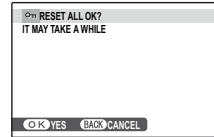

If the number of pictures affected is very large, a message will be displayed while the operation is in progress. Press **DISP/BACK** to exit before the operation is complete.



Protected pictures will be deleted when the memory card is formatted (🗨 101).

CROP

To create a cropped copy of a picture, play the picture back and select  **CROP** in the playback menu (📖 84).

- 1 Use the zoom control to zoom in and out and use the selector to scroll the picture until the desired portion is displayed (to exit to single-frame playback without creating a cropped copy, press **DISP/BACK**).

Zoom indicator



Navigation window shows portion of image currently displayed in monitor

If the size of the final copy will be **640**, **YES** will be displayed in yellow.

Intelligent Face Detection

If the picture was shot with Intelligent Face Detection (📖 33),  will be displayed in the monitor. Press the ▼ button to zoom in on the selected face.

- 2 Press **MENU/OK** to view the copy size. Larger crops produce larger copies.



- 3 Press **MENU/OK** to save the cropped copy to a separate file.



Pictures taken with other cameras can not be cropped.

RESIZE

To create a small copy of a picture, play the picture back and select **RESIZE** in the playback menu (84).

- 1 Highlight a size and press **MENU/OK** to display a confirmation dialog.



- 2 Press **MENU/OK** to copy the picture at the selected size.



IMAGE ROTATE

By default, pictures taken in tall orientation are displayed in wide orientation. Use this option to display pictures in the correct orientation in the monitor. It has no effect on pictures displayed on a computer or other device.



- Protected pictures can not be rotated. Remove protection before rotating pictures (📖 91).
- The camera may not be able to rotate pictures created with other devices.

To rotate a picture, play the picture back and select  **IMAGE ROTATE** in the playback menu (📖 84).

- 1 Press the selector down to rotate the picture 90° clockwise, up to rotate the picture 90° counterclockwise.

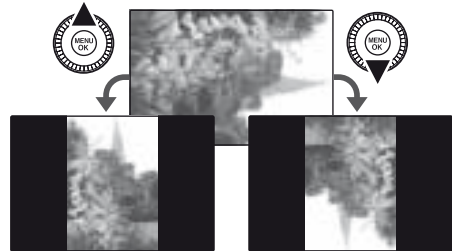

- 2 Press **MENU/OK** to confirm the operation (to exit without rotating the picture, press **DISP/BACK**).



The next time the picture is played back, it will automatically be rotated.

COPY COPY

Copy pictures from internal memory to a memory card.

- 1 Select **COPY COPY** in the playback menu.
- 2 Highlight one of the following options and press the selector right:

- **INTERNAL MEMORY** → **SD CARD**: Copy pictures from internal memory to a memory card.
- **SD CARD** → **INTERNAL MEMORY**: Copy pictures from a memory card to internal memory.

- 3 Highlight one of the following options and press **MENU/OK**:

- **FRAME**: Copy selected pictures. Press the selector left or right to view pictures and press **MENU/OK** to copy the current picture.
- **ALL FRAMES**: Copy all pictures.



- Copying ends when the destination is full.
- DPOF print information is not copied (68).

DISP. ASPECT

Choose how High Definition (HD) devices display pictures with an aspect ratio of 4 : 3 (this option is available only when an HDMI cable is connected). Select **16:9** to display the image so that it fills the screen with its top and bottom cropped out, **4:3** to display the entire image with black bands at either side.

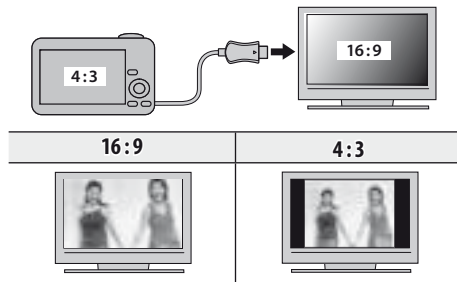

Photographs with an aspect ratio of 16 : 9 are displayed full screen, those with an aspect ratio of 3 : 2 in a black frame.

The Setup Menu

Using the Setup Menu

1 Display the setup menu.

1.1 Press **MENU/OK** to display the menu for the current mode.



1.2 Press the selector left to highlight a left tab.



1.3 Press the selector up or down to select **SET**.
The setup menu appears.

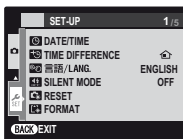

2 Adjust settings.

2.1 Press the selector right to activate the setup menu.



2.2 Press the selector up or down to highlight a menu item.



2.3 Press the selector right to display options for the highlighted item.



2.4 Press the selector up or down to highlight an option.





























2.5 Press **MENU/OK** to select the highlighted option.

















































2.6 Press **DISP/BACK** to exit from the menu.



Setup Menu Options

Menu item	Description	Options	Default
 DATE/TIME	Set the camera clock (📖 15).	—	—
 TIME DIFFERENCE	Set the clock to local time (📖 100).	🏠/↔	🏠
 言語/LANG.	Choose a language (📖 15).	—	ENGLISH
 SILENT MODE	Disables the AF-assist illuminator (except for the  shooting mode), operation sounds, shutter sound, and movie playback sound.	ON / OFF	OFF
 RESET	Reset all settings except  DATE/TIME ,  TIME DIFFERENCE ,  BACKGROUND COLOR , and  BATTERY TYPE to default values. A confirmation dialog will be displayed, press the selector up or down to highlight OK and press MENU/OK .	—	—
 FORMAT	Format internal memory or memory cards (📖 101).	—	—
 IMAGE DISP.	Choose how long pictures are displayed after shooting (📖 101).	3 SEC / 1.5 SEC / ZOOM / OFF	1.5 SEC
 FRAME NO.	Choose how files are named (📖 102).	CONT. / RENEW	CONT.
 OPERATION VOL.	Adjust the volume of camera controls.	 (high) /  (mid) /  (low) /  (mute)	
 SHUTTER VOLUME	Adjust the volume of the shutter sound.		
 SHUTTER SOUND	Choose the sound made by the shutter.	 1 /  2	 1
 PLAYBACK VOLUME	Adjust the volume for movie playback (📖 102).	—	7
 LCD BRIGHTNESS	Control the brightness of the display (📖 102).	-5 - +5	0
 MONITOR SUNLIGHT MODE	Select ON to make the display in the monitor easier to read in bright light.	ON / OFF	OFF

Menu item	Description	Options	Default
 EVF/LCD MODE	Choose 30 fps to increase battery life, 60 fps for improved display quality.	30 fps / 60 fps	30 fps
 LCD POWER SAVE	Choose whether to save power to increase battery life (📖 102).	 POWER SAVE ON /  POWER SAVE OFF	 POWER SAVE OFF
 AUTO POWER OFF	Choose the auto power off delay (📖 103).	2 MIN / 5 MIN / OFF	2 MIN
 Fn BUTTON	Choose the role played by the Fn button (📖 45).	 ISO /  FLASH /  WB /  IA /  IA /  IA /  IA /  IA /  Wi-Fi *	 ISO
 IS MODE	Enable image stabilization during shooting ( , CONTINUOUS) or only when the shutter button is pressed halfway ( SHOOTING ONLY). OFF turns image stabilization off. Choose this option when using a tripod (📖 18).	 1 /  2 / OFF	 1
 DIGITAL IMAGE STABILIZER	Choose ON to reduce blurring caused by camera shake when shooting movies (📖 103).	ON / OFF	ON
 RED EYE REMOVAL	Remove “red-eye” effects caused by the flash.	ON / OFF	ON
 INTELLIGENT DIGITAL ZOOM	Enable or disable intelligent digital zoom (📖 103).	ON / OFF	OFF
 MOVIE ZOOM TYPE	Choose the zoom type when recording movies (📖 60).	Dt / Opt	Opt
 SIDE ZOOM LEVER	Choose the setting of the side lever (📖 18).	AUTO BACK / H / M / L	H
 AF ILLUMINATOR	Turn the AF-assist illuminator on or off (📖 36).	ON / OFF	ON
 SAVE ORG IMAGE	Choose ON to save unprocessed copies of pictures taken using  RED EYE REMOVAL ,  PRO LOW-LIGHT MODE , or  HDR .	ON / OFF	OFF
 AUTOROTATE PB	Choose ON to automatically rotate “tall” (portrait-orientation) pictures during playback.	ON / OFF	ON

Menu item	Description	Options	Default
 BACKGROUND COLOR	Choose a color scheme.	—	—
 WIND FILTER	Choose ON to reduce the noise of the wind when shooting movies.	ON / OFF	OFF
 CUSTOM RESET	Reset all settings for mode C . A confirmation dialog will be displayed, press the selector up or down to highlight OK and press MENU/OK .	—	—
 WIRELESS SETTINGS*	Adjust settings for connection to a wireless network.	—	—
 PC AUTO SAVE SETTING*	Choose a destination for images uploaded using  PC AUTO SAVE .	—	—
 GEOTAGGING SET-UP*	Access location data options.	—	—
 BATTERY TYPE	Specify the type of battery used in the camera (📖 10).		
 DISCHARGE	Discharge rechargeable Ni-MH batteries (📖 104).	—	—
 DATE STAMP	Choose whether to add shooting date and time to the pictures.		OFF

* S9900W Series Only

For information on using wireless networks, visit <http://fujifilm-dsc.com/wifi/>.

TIME DIFFERENCE

When travelling, use this option to switch the camera clock instantly from your home time zone to the local time at your destination.

1 Specify the difference between local time and your home time zone.

1.1 Press the selector up or down to highlight  **LOCAL**.



1.2 Press the selector right to display the time difference.



1.3 Press the selector left or right to highlight **+**, **-**, hours, or minutes; press up or down to edit.







1.4 Press **MENU/OK** when settings are complete.



2 Switch between local time and your home time zone.

To switch between local time and your home time zone, highlight  **LOCAL** or  **HOME** and press **MENU/OK**.

-  **HOME**: Switch to the time currently selected for  **DATE/TIME** (📖 15).
-  **LOCAL**: Switch to local time. If this option is selected,  and the time and date will be displayed in yellow for three seconds each time the camera is turned on.

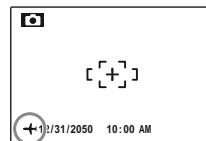

After changing time zones, check that the date and time are correct.

FORMAT

If a memory card is inserted in the camera, this option will format the memory card. If no memory card is inserted, this option will format internal memory. Highlight **OK** and press **MENU/OK** to begin formatting.



- All data—including protected pictures—will be deleted. Be sure important files have been copied to a computer or other storage device.
- Do not open the battery cover during formatting.

IMAGE DISP.

Choose an option other than **OFF** to display pictures in the monitor after shooting. Pictures can be displayed for 1.5 s (**1.5 SEC**), 3 s (**3 SEC**), or until the **MENU/OK** button is pressed (**ZOOM (CONTINUOUS)**). If **ZOOM (CONTINUOUS)** is selected, photos can be zoomed in to check focus and other fine details (📖 51). Note that **ZOOM (CONTINUOUS)** is disabled in continuous shooting mode (📖 46), and that the colors displayed at settings of **1.5 SEC** and **3 SEC** may differ from those in the final picture.

When the picture is zoomed in, the selector can

be used to view areas of the image not currently visible in the display.

When the picture was taken with **FACE DETECTION** turned on, detected face is zoomed. When more than one face was detected, you can move to the next face by pressing **▼**.

ZOOM (CONTINUOUS) is disabled in the following case:

- is selected in the shooting mode.
- An option other than **OFF** is selected for continuous shooting.
- **OFF** has no effect in continuous shooting, **ADVANCED FILTER**, **PRO LOW-LIGHT** and **HDR**.

[No.] FRAME NO.

New pictures are stored in image files named using a four-digit file number assigned by adding one to the last file number used. The file number is displayed during playback as shown at right.

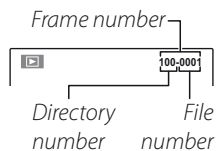

[No.] FRAME NO. controls whether file numbering is reset to 0001 when a new memory card is inserted or the current memory card is formatted.

- **CONTINUOUS:** Numbering continues from the last file number used or the first available file number, whichever is higher. Choose this option to reduce the number of pictures with duplicate file names.
- **RENEW:** Numbering is reset to 0001 after formatting or when a new memory card is inserted.



- If the frame number reaches 999-9999, the shutter release will be disabled (📖 119).
- Selecting **[C] RESET** (📖 97) resets **[No.] FRAME NO.** to **CONTINUOUS** but does not reset frame numbering.
- Frame numbers for pictures taken with other cameras may differ.

[🔊] PLAYBACK VOLUME

Press the selector up or down to choose volume for movie playback and press **MENU/OK** to select.

[☀️] LCD BRIGHTNESS

Press the selector up or down to choose display brightness and press **MENU/OK** to select.

[P.S.] LCD POWER SAVE

Choose whether to save power to increase battery life. This option does not take effect during playback or recording movies.

Option	Description
[P.S.] POWER SAVE ON	The display dims to save power if no operations are performed for a few seconds. Normal brightness can be restored by pressing the shutter button halfway.
[P.S.] POWER SAVE OFF	Automatic dimming off.

AUTO POWER OFF

Choose the length of time before the camera turns off automatically when no operations are performed. Shorter times increase battery life; if **OFF** is selected, the camera must be turned off manually. Note that regardless of the option selected, the camera will not turn off automatically when connected to a printer (📖 65) or computer (📖 73) or when a slide show is in progress (📖 89).

Reactivating the Camera

To reactivate the camera after it has turned off automatically, use the **ON/OFF** switch or press the  button for about a second (📖 14).

DIGITAL IMAGE STABILIZER

If **ON** is selected, camera vibrations that occur when shooting movies are corrected, allowing you to shoot images with only minor vibrations.



Digital image stabilizer is unavailable when shooting still images.

INTELLIGENT DIGITAL ZOOM

If **ON** is selected, selecting **T** at the maximum optical zoom position triggers intelligent digital zoom, further magnifying the image while processing it for sharp, high-resolution results.





- Intelligent digital zoom may end when another mode is selected.
- Intelligent digital zoom may sometimes produce lower quality images than optical zoom.
- The time needed to record images increases.
- Intelligent digital zoom is not available in continuous mode or during movie recording.

Zoom indicator,
INTELLIGENT DIGITAL
ZOOM off

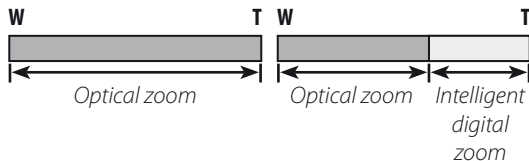
Zoom indicator,
INTELLIGENT DIGITAL
ZOOM on (except for super
macro mode)



DISCHARGE (Ni-MH Batteries Only)

The capacity of rechargeable Ni-MH batteries may be temporarily reduced when new, after long periods of disuse, or if they are repeatedly recharged before being fully discharged. Capacity can be increased by repeatedly discharging the batteries using the  **DISCHARGE** option and recharging them in a battery charger (sold separately). Do not use  **DISCHARGE** with non-rechargeable batteries, and note that the batteries will not discharge if the camera is powered by an optional AC power adapter and DC coupler.

- 1 Selecting  **DISCHARGE** displays a confirmation dialog. Press **MENU/OK**.



- 2 Select **OK**.



- 3 Press **MENU/OK** to begin discharging the batteries. When the batteries are fully discharged, the battery level indicator will blink red and the camera will turn off. To cancel the process before the batteries are fully discharged, press **DISP/BACK**.





DATE DATE STAMP

To add shooting date and time, choose  + .

To add only shooting date, choose . When **OFF** is selected, no information will be added to the pictures.



- Added shooting date and time can not be deleted from the pictures. To take pictures without date and time, select **OFF** for **DATE DATE STAMP**.
- When the camera clock is not set, setting dialog will be displayed. Set the date and time ( 15).
- When using **DATE DATE STAMP**, selecting **WITHOUT DATE** for  **PRINT ORDER (DPOF)** is recommended ( 68).
- Date and time can not be added to the movies and the panoramas.

Optional Accessories

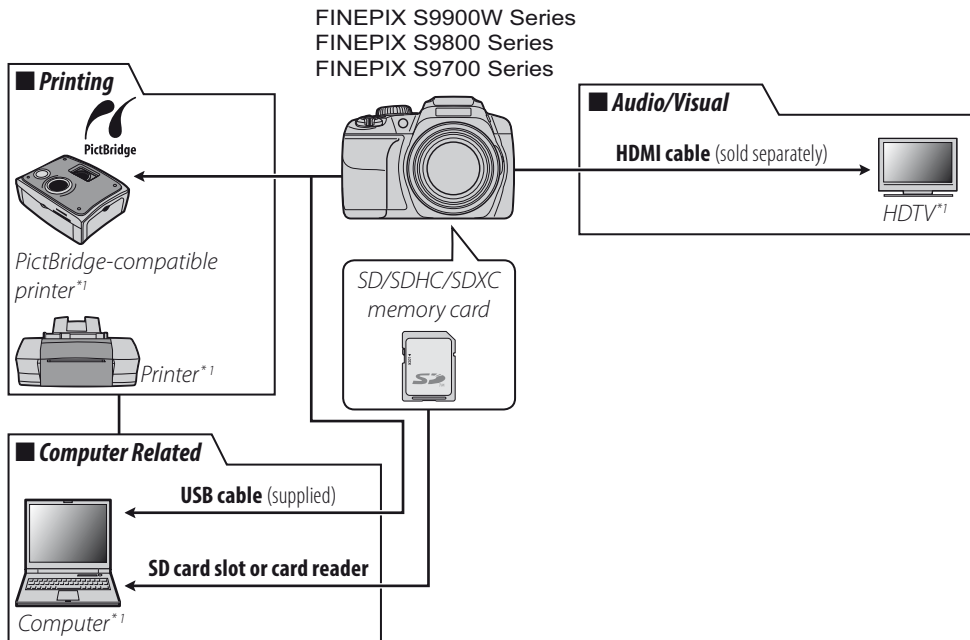

The camera supports a wide range of accessories from FUJIFILM and other manufacturers.



*¹ Available separately.

Accessories from FUJIFILM

The following optional accessories are available from FUJIFILM. For the latest information on the accessories available in your region, check with your local FUJIFILM representative or visit http://www.fujifilm.com/products/digital_cameras/index.html.

AC power adapter	AC-5VX (requires CP-04 DC coupler)	Use for extended playback or when copying pictures to a computer (shape of adapter and plug vary with region of sale).	
DC coupler	CP-04	Connect the AC-5VX AC power adapter to the camera.	

Caring for the Camera

To ensure continued enjoyment of the product, observe the following precautions.

Storage and Use

If the camera will not be used for an extended period, remove the battery and memory card. Do not store or use the camera in locations that are:

- exposed to rain, steam, or smoke
- very humid or extremely dusty
- exposed to direct sunlight or very high temperatures, such as in a closed vehicle on a sunny day
- extremely cold
- subject to strong vibration
- exposed to strong magnetic fields, such as near a broadcasting antenna, power line, radar emitter, motor, transformer, or magnet
- in contact with volatile chemicals such as pesticides
- next to rubber or vinyl products

Water and Sand

Exposure to water and sand can also damage the camera and its internal circuitry and mechanisms. When using the camera at the beach or seaside, avoid exposing the camera to water or sand. Do not place the camera on a wet surface.

Condensation

Sudden increases in temperature, such as occur when entering a heated building on a cold day, can cause condensation inside the camera. If this occurs, turn the camera off and wait an hour before turning it on again. If condensation forms on the memory card, remove the card and wait for the condensation to dissipate.

Cleaning



Use a blower to remove dust from the lens and monitor, then gently wipe with a soft, dry cloth. Any remaining stains can be removed by wiping gently with a piece of FUJIFILM lens-cleaning paper to which a small amount of lens-cleaning fluid has been applied. Care should be taken to avoid scratching the lens or monitor. The camera body can be cleaned with a soft, dry cloth. Do not use alcohol, thinner, or other volatile chemicals.

Traveling

Keep the camera in your carry-on baggage. Checked baggage may suffer violent shocks that could damage the camera.

Troubleshooting

Power and Battery

Problem	Possible cause	Solution	Page	
The camera does not turn on.	The batteries are exhausted.	Insert fresh or fully-charged spare batteries.	9	
	The batteries are not in the correct orientation.	Re-insert the batteries in the correct orientation.	9	
	The battery-chamber cover is not latched.	Latch the battery-chamber cover.	10	
	The AC power adapter and DC coupler are not connected properly.	Make sure that the AC power adapter and DC coupler are properly connected.	—	
	The camera has been left for an extended period with no batteries inserted and the AC power adapter/DC coupler unplugged.	After inserting the batteries or connecting the AC power adapter/DC coupler, wait a few moments before turning the camera on.	—	
Power supply	The batteries are cold.	Warm the batteries by placing them in a pocket or other warm place and re-insert them in the camera immediately before taking a picture.	v	
	There is dirt on the battery terminals.	Clean the terminals with a soft, dry cloth.	—	
	ON is selected for MONITOR SUNLIGHT MODE .	Select OFF to reduce the drain on the battery.	6	
	The batteries run down quickly.	The camera is in SRAUTO mode.	Select another shooting mode.	22
	The batteries are new, have been left unused for an extended period, or have been recharged without first being fully discharged (rechargeable Ni-MH batteries only).	Discharge Ni-MH batteries using the  DISCHARGE option and recharge them in a battery charger (sold separately). If the batteries do not hold a charge after repeated discharging and recharging, they have reached the end of their service life and must be replaced.	104	
	 CONTINUOUS is selected for  AF MODE .	Select a different focusing option.	82	
The camera turns off suddenly.	The batteries are exhausted.	Insert fresh or fully-charged spare batteries.	9	
	The AC power adapter or DC coupler has been disconnected.	Make sure that the AC power adapter and DC coupler are properly connected.	—	

Menus and Displays

Problem	Possible cause	Solution	Page
Menus and displays are not in English.	English is not selected for the  言語/LANG.	Select ENGLISH .	15, 97

Shooting

Problem	Possible cause	Solution	Page
Taking pictures	Memory is full.	Insert a new memory card or delete pictures.	11, 58
	Memory is not formatted.	Format the memory card.	101
	There is dirt on the memory card contacts.	Clean the contacts with a soft, dry cloth.	—
	The memory card is damaged.	Insert a new memory card.	11
	The batteries are exhausted.	Insert fresh or fully-charged spare batteries.	9
	The camera has turned off automatically.	Turn the camera on.	14
The monitor goes dark after shooting.	The flash has fired.	The monitor may darken while the flash charges. Wait for the flash to charge.	38
Focus	The subject is close to the camera.	Select macro mode.	37
	The subject is far away from the camera.	Cancel macro mode.	
	The camera does not focus.	The subject is not suited to autofocus.	Use focus lock.

	Problem	Possible cause	Solution	Page
Intelligent Face Detection	Face detection not available.	Intelligent Face Detection is not available in the current shooting mode.	Choose a different shooting mode.	22
	No face is detected.	The subject's face is obscured by sunglasses, a hat, long hair, or other objects.	Remove the obstructions.	33
		The subject's face occupies only a small area of the frame.	Change the composition so that the subject's face occupies a larger area of the frame.	
		The subject's head is tilted or horizontal.	Ask the subject to hold their head straight.	
		The camera is tilted.	Hold the camera straight.	18
		The subject's face is poorly lit.	Shoot in bright light.	—
Wrong subject selected.	The selected subject is closer to the center of the frame than the main subject.	Recompose the picture or turn face detection off and frame the picture using focus lock.	35, 76	
Close-ups	Macro mode is not available.	Macro mode is not available in the current shooting mode.	Choose a different shooting mode.	22, 37
Flash	The flash does not fire.	The flash is lowered.	Raise the flash.	38
		The flash is charging.	Wait for the flash to charge.	38
		The flash is not available in the current shooting mode.	Choose a different shooting mode.	22
		The batteries are exhausted.	Insert fresh or fully-charged spare batteries.	9
		The camera is in super macro or continuous shooting mode.	Turn super macro and continuous shooting modes off.	37, 46
	Flash mode not available.	The desired flash mode is not available in the current shooting mode.	Choose a different shooting mode.	22
	The flash does not fully light the subject.	The subject is not in range of the flash.	Position the subject in range of the flash.	124
		The flash window is obstructed.	Hold the camera correctly.	18
	Fast shutter speed selected.	Choose a slower shutter speed.	30, 31	

	Problem	Possible cause	Solution	Page
Problem images	Pictures are blurred.	The lens is dirty.	Clean the lens.	108
		The lens is blocked.	Keep objects away from the lens.	18
		!AF is displayed during shooting and the focus frame is displayed in red.	Check focus before shooting.	117
		! is displayed during shooting.	Use the flash or a tripod.	38
	Pictures are mottled.	The ambient temperature is high and the subject is poorly lit.	This is normal and does not indicate a malfunction.	—
		The camera has been used continuously at high temperatures or a temperature warning is displayed.	Turn the camera off and wait for it to cool down.	—
	Vertical lines appear in pictures.	The camera has been used continuously at high temperatures.	Turn the camera off and wait for it to cool down.	—

Playback



	Problem	Possible cause	Solution	Page
Pictures	Pictures are grainy.	The pictures were taken with a different make or model of camera.	—	—
	Playback zoom unavailable.	The picture has been resized or cropped to 640 or is from another make or model of camera.	—	53
Audio	No sound in movie playback.	Playback volume is too low.	Adjust playback volume.	102
		The microphone was obstructed.	Hold the camera correctly during recording.	60
		The speaker is obstructed.	Hold the camera correctly during playback.	63
Deletion	Selected pictures not deleted.	Some of the pictures selected for deletion are protected.	Remove protection using the device with which it was originally applied.	91
Frame no.	File numbering is unexpectedly reset.	The battery-chamber cover was opened while the camera was on.	Turn the camera off before opening the battery-chamber cover.	14

Connections

	Problem	Possible cause	Solution	Page
TV	Monitor is off.	The camera is connected to a TV.	View pictures on the TV.	64
	No picture or sound.	The camera is not properly connected.	Connect the camera correctly.	64
		Input on the television is set to "TV".	Set the TV input correctly.	—
		The volume on the television is too low.	Adjust the volume.	—
Computer	The computer does not recognize the camera.	The camera is not properly connected.	Connect the camera correctly.	73
PictBridge	Pictures can not be printed.	The camera is not properly connected.	Connect the camera correctly.	65
		The printer is off.	Turn the printer on.	—
	Only one copy is printed.	The printer is not PictBridge-compatible.	—	—
	The date is not printed.			

Wireless Networks (S9900W Series Only)

 For information on troubleshooting wireless networks, visit http://faq.fujifilm.com/digitalcamera/faq_product.html?pid=S.

Problem	Possible cause	Solution	Page
Problem connecting or uploading pictures to smartphone.	The smartphone is too far away.	Move the devices closer.	—
	Nearby devices are causing radio interference.	Move the camera and smartphone away from microwave ovens or cordless phones.	—
Can not upload images.	The smartphone is connected to another device.	The smartphone and camera can connect to only one device at a time. End the connection and try again.	—
	There are several smartphones in the vicinity.	Try connecting again. The presence of multiple smartphones can make connection difficult.	—
	The current image is a movie or was created on another device and can not be uploaded to a smartphone.	—	—
Smartphone will not display pictures.	Select ON for  WIRELESS SETTING > RE-SIZE IMAGE FOR SMARTPHONE  . Selecting OFF increases upload times for larger images; in addition, some phones may not display images over a certain size.	—	—





 * For information on using wireless networks, visit <http://fujifilm-dsc.com/wifi/>.









Miscellaneous

Problem	Possible cause	Solution	Page
Nothing happens when the shutter button is pressed.	Temporary camera malfunction.	Remove and reinsert the batteries or disconnect and reconnect the AC power adapter/DC coupler.	9
	The batteries are exhausted.	Insert fresh or fully-charged spare batteries.	9
	The camera is connecting to a wireless network.	Disconnect from the wireless network.	—
The camera does not function as expected.	Temporary camera malfunction.	Remove and reinsert the batteries or disconnect and reconnect the AC power adapter/DC coupler. If the problem persists, contact your FUJIFILM dealer.	9
I want to use an AC power adapter and DC coupler overseas.	Check the label on the AC power adapter.	The AC power adapter can be used with voltages of 100–240V and power frequency of 50/60Hz. However, power outlets differ depending on the regions. Consult your travel agent for information on plug adapters.	—
Hue or content of display changes unexpectedly.	ON is selected for MONITOR SUNLIGHT MODE .	Choose OFF for MONITOR SUNLIGHT MODE .	6
Date and time added by DATE DATE STAMP are not correct.	The camera clock is not correctly set.	Reset the date and time.	15
Date and time are added to the pictures.	[31] + [☺] or [31] is selected for DATE DATE STAMP option.	Added shooting date and time can not be deleted from the pictures. To take pictures without date and time, select OFF for DATE DATE STAMP .	105





Warning Messages and Displays

The following warnings are displayed in the monitor:

Warning	Description	Solution
 (red)	Batteries are low.	Insert fresh or fully-charged spare batteries.
 (blinks red)	Batteries are exhausted.	
	Slow shutter speed. Picture may be blurred.	Use the flash or mount the camera on a tripod.
!AF (displayed in red with red focus frame)	The camera can not focus.	<ul style="list-style-type: none">• Use focus lock to focus on another subject at the same distance, then recompose the picture (p. 35).• Use macro mode to focus when taking close-ups.
Aperture or shutter speed shown in red	The subject is too bright or too dark. The picture will be over- or under-exposed.	If the subject is dark, use the flash.
FOCUS ERROR	Camera malfunction.	Turn the camera off and then on again, taking care not to touch the lens. If the message persists, contact a FUJIFILM dealer.
LENS CONTROL ERROR		
	TURN THE CAMERA OFF, REMOVE LENS CAP OR OBSTRUCTION AND TURN THE CAMERA ON	
	The camera has been used continuously at high temperatures. If no action is taken, the camera will turn off automatically.	Turn the camera off and wait for it to cool.

Warning	Description	Solution
CARD NOT INITIALIZED	The memory card is not formatted or the memory card was formatted in a computer or other device.	Format the memory card using the  FORMAT option in the camera setup menu ( 101).
	The memory card contacts require cleaning.	Clean the contacts with a soft, dry cloth. If the message is repeated, format the memory card ( 101). If the message persists, replace the memory card.
	Camera malfunction.	Contact a FUJIFILM dealer.
PROTECTED CARD	The memory card is locked.	Unlock the memory card ( 11).
BUSY	The memory card is incorrectly formatted.	Use the camera to format the memory card ( 101).
CARD ERROR	The memory card is not formatted for use in the camera.	Format the memory card ( 101).
	The memory card contacts require cleaning or the memory card is damaged.	Clean the contacts with a soft, dry cloth. If the message is repeated, format the memory card ( 101). If the message persists, replace the memory card.
	Incompatible memory card.	Use a compatible memory card.
	Camera malfunction.	Contact a FUJIFILM dealer.
 MEMORY FULL	The memory card is full; pictures can not be recorded.	Delete pictures or insert a memory card with more free space.
WRITE ERROR	Memory card error or connection error.	Re-insert the memory card or turn the camera off and then on again. If the message persists, contact a FUJIFILM dealer.
	Not enough memory remaining to record additional pictures.	Delete pictures or insert a memory card with more free space.
	The memory card is not formatted.	Format the memory card ( 101).

Warning	Description	Solution
READ ERROR	The file is corrupt or was not created with the camera.	The file can not be played back.
	The memory card contacts require cleaning.	Clean the contacts with a soft, dry cloth. If the message is repeated, format the memory card (🗨 101). If the message persists, replace the memory card.
	Camera malfunction.	Contact a FUJIFILM dealer.
FRAME NO. FULL	The camera has run out of frame numbers (current frame number is 999-9999).	Format the memory card and select RENEW for the 🗨 FRAME NO. option in the ⚙ SET-UP menu. Take a picture to reset frame numbering to 100-0001, then return to the 🗨 FRAME NO. menu and select CONTINUOUS .
TOO MANY FRAMES	An attempt was made to search more than 5,000 images.	The maximum number of images on which searches can be performed is 5,000.
PROTECTED FRAME	An attempt was made to delete or rotate a protected picture.	Remove protection and try again (🗨 91).
📷 CAN NOT CROP	An attempt was made to crop a 📷 picture.	These pictures can not be cropped.
CAN NOT CROP	The picture selected for cropping is damaged or was not created with the camera.	
📷 CANNOT EXECUTE	An attempt was made to resize a 📷 picture.	An attempt was made to create a resized copy at a size equal to or larger than the original. Choose a smaller size.
📷 CANNOT EXECUTE	An attempt was made to resize a 📷 picture.	
📷 CANNOT EXECUTE	An attempt was made to resize a 📷 picture.	

Warning	Description	Solution
DPOF FILE ERROR	The DPOF print order on the current memory card contains more than 999 images.	The maximum number of images to which DPOF print order can be tagged is 999 per memory card.
CAN NOT SET DPOF	The picture can not be printed using DPOF.	—
 CAN NOT SET DPOF	Movies can not be printed using DPOF.	—
CAN NOT ROTATE	The picture is protected.	Remove protection before rotating pictures.
 CAN NOT ROTATE	Movies can not be rotated.	—
 CANNOT EXECUTE	Resize or red-eye removal can not be applied to the selected picture.	—
 CANNOT EXECUTE	Red-eye removal can not be applied to movies.	—
DEACTIVATE SILENT MODE	An attempt was made to adjust the volume with the camera in silent mode.	Exit silent mode before adjusting the volume.
COMMUNICATION ERROR	A connection error occurred while pictures were being printed or copied to a computer or other device.	Confirm that the device is turned on and that the USB cable is connected.
PRINTER ERROR	Printer out of paper or ink, or other printer error.	Check printer (see printer manual for details). To resume printing, turn the printer off and then turn it back on.
PRINTER ERROR RESUME?		Check printer (see printer manual for details). If printing does not resume automatically, press MENU/OK to resume.
CAN NOT BE PRINTED	An attempt was made to print a movie, a picture not created with the camera, or a picture in a format not supported by the printer.	Movies and some pictures created with other devices can not be printed. If the picture was created with the camera, check the printer manual to confirm that the printer supports the JFIF-JPEG or Exif-JPEG format. If it does not, the pictures can not be printed.

Memory Card Capacity

The following table shows the recording time or number of pictures available at different image sizes. All figures are approximate; file size varies with the scene recorded, producing wide variations in the number of files that can be stored. The number of exposures or length remaining may not diminish at an even rate.

■ Photographs

		L				M				S			
		4:3	3:2	16:9	1:1	4:3	3:2	16:9	1:1	4:3	3:2	16:9	1:1
4 GB	FINE	480	540	640	640	950	1,060	1,260	1,270	1,870	2,050	3,400	2,430
	NORMAL	960	1,070	1,270	1,270	1,860	2,070	2,430	2,450	3,530	3,910	6,160	4,510
8 GB	FINE	980	1,100	1,300	1,300	1,920	2,180	2,530	2,600	3,750	4,240	6,840	4,920
	NORMAL	1,930	2,160	2,550	2,550	3,740	4,210	4,880	4,930	7,090	7,950	12,370	9,110



■ Movie

	HD 1920 × 1080 (60 fps) ¹	HD 1280 × 720 (30 fps) ¹	640 640 × 480 (30 fps)	HS 640 × 480 (120 fps) ²	HS 320 × 240 (240 fps) ²	HS 320 × 120 (480 fps) ²
4 GB	28 min.	28 min.	109 min.	43 min.	85 min.	43 min.
8 GB	57 min.	57 min.	219 min.	86 min.	170 min.	86 min.

1 Use a CLASSIC card or better. Individual movies can not exceed 29 minutes in length.

2 Use a CLASSIC card or better. Individual movies can not exceed 30 seconds in length.

Specifications

System	
Model	Digital Camera FinePix S9900W/S9800/S9700 Series
Effective pixels	16.2 million
Image sensor	1/2.3-in., square-pixel CMOS with primary color filter
Storage media	• Internal memory (approx. 38 MB) • SD/SDHC/SDXC memory cards
File system	Compliant with Design Rule for Camera File System (DCF), Exif 2.3, and Digital Print Order Format (DPOF)
File format	• Still pictures: Exif 2.3 JPEG (compressed) • Movies: MOV (H.264) • Audio: Linear PCM/stereo sound
Image size (pixels)	• L 4:3: 4,608 × 3,456 • L 3:2: 4,608 × 3,072 • L 16:9: 4,608 × 2,592 • L 1:1: 3,456 × 3,456 • M 4:3: 3,264 × 2,448 • M 3:2: 3,264 × 2,176 • M 16:9: 3,264 × 1,840 • M 1:1: 2,432 × 2,432 • S 4:3: 2,304 × 1,728 • S 3:2: 2,304 × 1,536 • S 16:9: 1,920 × 1,080 • S 1:1: 1,728 × 1,728 •  MOTION PANORAMA 360: 1,624 × 11,520 (tall)/11,520 × 1,080 (wide) •  MOTION PANORAMA 180: 1,624 × 5,760 (tall)/5,760 × 1,080 (wide) •  MOTION PANORAMA 120: 1,624 × 3,840 (tall)/3,840 × 1,080 (wide)
Lens	Fujinon 50× optical zoom lens, F/2.9 (wide angle)–6.5 (telephoto)
Focal length	f=4.3 mm–215 mm (35-mm format equivalent: 24 mm–1200 mm)
Digital zoom	• Intelligent digital zoom: approx. 2.0× (up to 100× with optical zoom)
Aperture	F2.9/F8.4* (wide angle), F6.5/F7.8/F19.0* (telephoto), *uses Neutral Density (ND) filter
Focus range (distance from front of lens)	Approx. 40 cm (1.3 ft.)–infinity (wide angle); approx. 3.5 m (11.4 ft.)–infinity (telephoto) • Macro: approx. 7 cm–3.0 m/2.7 in.–9.8 ft. (wide angle); approx. 3.5 m (11.4 ft.)–5.0 m (16.4 ft.) (telephoto) • Super macro: approx. 1 cm–100 cm/0.3 in.–3.2 ft. (wide angle)

System																									
Sensitivity	Standard output sensitivity equivalent to ISO 100, 200, 400, 800, 1600, 3200, 6400, 12800; AUTO (400), AUTO (800), AUTO (1600), AUTO (3200)																								
Metering	256-segment through-the-lens (TTL) metering; MULTI, SPOT, AVERAGE																								
Exposure control	Programmed AE, shutter-priority AE, aperture-priority AE, and manual exposure																								
Exposure compensation	-2 EV - +2 EV in increments of 1/3 EV (P , S , and A modes)																								
Picture stabilization	Optical stabilization, lens shift																								
Shutter speed (combined mechanical and electronic shutter)	<ul style="list-style-type: none"> • P, S, A, M: 8 s - 1/1,700 S • C: 1/8 s - 1/1,700 S • S: 3 s - 1/1,500 S • B: 8 s - 1/2 s • Other modes: 1/4 s - 1/1,700 S 																								
Continuous	<table border="1" style="width: 100%; border-collapse: collapse;"> <thead> <tr> <th style="width: 15%;"></th> <th style="width: 35%;">Approx. frame rate (fps)^{*1}</th> <th style="width: 50%;">Continuous frames (Image size)^{*2}</th> </tr> </thead> <tbody> <tr> <td></td> <td>3.0</td> <td>10</td> </tr> <tr> <td></td> <td>5.0</td> <td>10</td> </tr> <tr> <td></td> <td>10</td> <td>10</td> </tr> <tr> <td></td> <td>60</td> <td>60 (max. image size: 1080 x 960)</td> </tr> <tr> <td></td> <td>120</td> <td>60 (max. image size: 640 x 480)</td> </tr> <tr> <td></td> <td>10</td> <td>10/20 (S)</td> </tr> <tr> <td></td> <td>1.2</td> <td>3 frames (selected exposure, overexposure, underexposure)</td> </tr> </tbody> </table>		Approx. frame rate (fps) ^{*1}	Continuous frames (Image size) ^{*2}		3.0	10		5.0	10		10	10		60	60 (max. image size: 1080 x 960)		120	60 (max. image size: 640 x 480)		10	10/20 (S)		1.2	3 frames (selected exposure, overexposure, underexposure)
	Approx. frame rate (fps) ^{*1}	Continuous frames (Image size) ^{*2}																							
	3.0	10																							
	5.0	10																							
	10	10																							
	60	60 (max. image size: 1080 x 960)																							
	120	60 (max. image size: 640 x 480)																							
	10	10/20 (S)																							
	1.2	3 frames (selected exposure, overexposure, underexposure)																							
	*1 The frame rate varies with shooting conditions and the number of images recorded.																								
	*2 Use a CLASS card or better.																								
Bracketing	±1/3 EV, ±2/3 EV, ±1 EV																								
Focus	<ul style="list-style-type: none"> • Mode: CENTER/MULTI/AREA/CONTINUOUS/TRACKING • Autofocus system: Contrast-detect TTL AF 																								
White balance	Automatic scene detection; six manual preset modes for direct sunlight, shade, daylight fluorescent, warm white fluorescent, cool white fluorescent, and incandescent lighting; custom white balance																								
Self-timer	Off, 2 sec, 10 sec, Interval shooting																								

System	
Flash	Manual pop-up flash with CMOS-metered auto flash control (using monitor pre-flashes); effective range when sensitivity is set to ISO AUTO is approx. 40 cm–7.0 m/1.3 ft.–22.9 ft. (wide angle) or 2.5 m–3.6 m/8.2 ft.–11.8 ft. (telephoto); effective range in macro mode is approx. 30 cm–3.0 m/0.9 ft.–9.8 ft. (wide angle) or 2.0 m–3.0 m/6.5 ft.–9.8 ft. (telephoto)
Flash modes	Auto, forced flash, off, slow synchro (red-eye removal off); auto with red-eye removal, forced flash with red-eye removal, off, slow sync with red-eye removal (red-eye removal on)
Electronic viewfinder (EVF)	0.2-in. (0.5 cm), 920k-dot color LCD viewfinder
Frame coverage	Approx. 97% (shooting), 100% (playback)
Monitor	3.0-in. (7.6 cm), 460k-dot color LCD monitor
Frame coverage	Approx. 97% (shooting), 100% (playback)
Movie frame rate	<ul style="list-style-type: none"> • HS 1920 × 1080: 1080i, 60 fps • HS 640 × 480 (VGA): 30 fps • HS 320 × 240: 240 fps <ul style="list-style-type: none"> • HD 1280 × 720: 720p, 30 fps • HS 640 × 480: 120 fps • HS 320 × 120: 480 fps
Input/output terminals	
HDMI output	HDMI Mini Connector
Digital input/output	USB 2.0 High Speed

Power supply/other**Power sources**

- AA alkaline batteries (x4)
- AA lithium batteries (x4; available from third-party suppliers)
- AA rechargeable nickel-metal hydride (Ni-MH) batteries (x4; available from third-party suppliers)
- AC-5VX AC power adapter and CP-04 DC coupler (sold separately)

Battery life (approximate number of frames that can be taken with fresh or fully charged batteries)

Battery type	Approximate number of frames
Alkaline (type supplied with camera)	300
Lithium	700
Ni-MH	500

CIPA standard, measured in  (auto) mode using batteries supplied with camera (alkaline batteries only) and SD memory card.

Note: Number of shots that can be taken with battery varies with battery charge level and will decline at low temperatures.

Camera dimensions

122.6 mm x 86.9 mm x 116.2 mm/4.8 in. x 3.4 in. x 4.5 in. (W x H x D), excluding projections

Shooting weight

Approx. 670 g/23.6 oz., including batteries and memory card

Camera weight

Approx. 577 g/20.3 oz., excluding batteries, accessories, and memory cards

Operating conditions

• **Temperature:** 0 °C – +40 °C/+32 °F – +104 °F • **Humidity:** 10% – 80% (no condensation)

Wireless transmitter (S9900W Series Only)**Standards**

IEEE 802.11b/g/n (standard wireless protocol)

Operating frequency

- **U. S. A., Canada, Taiwan:** 2,412 MHz–2,462 MHz (11 channels)
- **Other countries:** 2,412 MHz–2,472 MHz (13 channels)

Access protocols

Infrastructure

Notices

- Specifications subject to change without notice. FUJIFILM shall not be held liable for damages resulting from errors in this manual.
- Although the monitor is manufactured using advanced high-precision technology, small bright points and anomalous colors (particularly in the vicinity of text) may appear. This is normal for this type of monitor and does not indicate a malfunction; images recorded with the camera are unaffected.
- Digital cameras may malfunction when exposed to strong radio interference (e.g., electric fields, static electricity, or line noise).
- Due to the type of lens used, some distortion may occur at the periphery of images. This is normal.

FUJIFILM

FUJIFILM Corporation

7-3, AKASAKA 9-CHOME, MINATO-KU, TOKYO 107-0052, JAPAN

http://www.fujifilm.com/products/digital_cameras/index.html

Please contact your local distributor for repairs and technical support. (see Worldwide Network list)

Option		Shooting mode																									
		SR/AUTO	📷	Adv.					SP																		
		SR/AUTO	📷	📷	📷	📷	📷	📷	📷	📷	📷	📷	📷	📷	📷	📷	📷	📷	📷	📷	📷	TEXT	PANORAMA	P	S	A	M
📷	📷	✓	✓		✓	✓	✓	✓	✓	✓	✓	✓	✓	✓	✓	✓	✓	✓	✓	✓	✓	✓	✓	✓	✓	✓	✓
	📷		✓		✓	✓	✓	✓															✓	✓	✓	✓	✓
	📷	✓	✓		✓	✓	✓	✓	✓	✓	✓	✓	✓	✓	✓	✓	✓	✓	✓	✓	✓	✓	✓	✓	✓	✓	✓
📷																							✓	✓	✓	✓	✓
📷		✓	✓	✓	✓	✓	✓		✓	✓	✓	✓	✓	✓	✓	✓	✓	✓	✓	✓	✓	✓		✓	✓	✓	✓
📷	OFF		✓	✓	✓	✓	✓	✓	✓	✓		✓	✓ ¹	✓	✓	✓ ¹	✓	✓	✓	✓	✓	✓ ¹	✓ ¹	✓	✓	✓	✓
	ON	✓	✓	✓	✓	✓	✓	✓	✓	✓				✓	✓		✓	✓	✓	✓				✓	✓	✓	✓
📷 /																								✓	✓	✓	✓
📷																								✓	✓	✓	✓
📷 (📷)		✓	✓	✓	✓	✓	✓	✓	✓	✓	✓	✓	✓	✓	✓	✓	✓	✓	✓	✓	✓	✓		✓	✓	✓	✓
📷																								✓	✓	✓	✓
📷																								✓	✓	✓	✓
📷		✓	✓	✓	✓	✓	✓	✓	✓	✓	✓	✓	✓	✓	✓	✓	✓	✓	✓	✓	✓	✓	✓	✓	✓	✓	✓
📷		✓	✓	✓	✓	✓	✓	✓	✓	✓	✓	✓	✓	✓	✓	✓	✓	✓	✓	✓	✓	✓	✓	✓	✓	✓	✓
📷			✓				✓		✓	✓	✓	✓	✓	✓	✓	✓	✓	✓	✓	✓	✓	✓		✓	✓	✓	✓
📷		✓	✓	✓	✓	✓	✓	✓	✓	✓			✓	✓			✓	✓				✓	✓	✓	✓	✓	✓

1 Automatically optimized for selected shooting mode.

2 Flash turns off automatically in super macro mode (📷).

3 Flash disabled in all shooting modes if lowered.

4 Disabled if flash fires when set to **AUTO** or 📷 or if flash is set to 📷 or 📷 and subject is poorly lit.

5 Image sizes over **S** are set to **S**.

6 Image sizes over **M** are set to **M**.

7 Fixed at 📷 when Intelligent Face Detection is on.