

**SAMSUNG**

SM-R150

# User Manual

# Table of Contents

## Basics

- 3 Read me first
- 4 About the Gear IconX
- 6 Package contents
- 7 Device layout
- 8 Preparing the earbuds for use
- 10 Battery
- 14 Indicator lights identification

## Using the earbuds

- 16 Activating the earbuds
- 17 Wearing the earbuds correctly
- 18 Connecting the earbuds to a mobile device
- 20 Using the earbuds without a mobile device
- 21 Coupling the two earbuds
- 21 Setting the main earbud
- 22 Using the touchpad
- 24 Transferring music files to the earbuds
- 28 Listening to music
- 30 Recording exercise information
- 33 Measuring your heart rate during a workout
- 34 Using call features
- 35 Using ambient sound mode

## Samsung Gear and Gear IconX PC Manager

- 36 Samsung Gear
- 41 Gear IconX PC Manager

## Appendix

- 43 Troubleshooting
- 46 Turning off and restarting the earbuds
- 47 Removing the battery

# Basics

## Read me first

Please read this manual before using this device to ensure safe and proper use.

- Images may differ in appearance from the actual product. Content is subject to change without prior notice. You can access the full user manual for more information. Visit [www.samsung.com](http://www.samsung.com) to view device information, the user manual, and more.
- Before using other devices, make sure they are compatible with the earbuds. Visit [www.samsung.com](http://www.samsung.com) to see a list of compatible mobile devices.
- Prevent the device from being submerged in liquid or exposed to pressurised water jets, such as from a shower. Do not wear the device during activities, such as showering or swimming. Doing so can damage the device.
- This product includes certain free/ open source software. To see the instructions for viewing the open source license, go to the Samsung website ([opensource.samsung.com](http://opensource.samsung.com)).

## Instructional icons



**Warning:** situations that could cause injury to yourself or others



**Caution:** situations that could cause damage to your device or other equipment



**Notice:** notes, usage tips, or additional information

## About the Gear IconX

Gear IconX wireless sports earbuds allow you to track your activity levels as well as play music. You can save music files to the Gear IconX earbuds and play them directly from the earbuds, or listen to music played from the connected mobile device. The Gear IconX earbuds also record exercise information, such as the activity duration, your heart rate, and the number of calories you have burnt, using the built-in sensor.



Do not wear the earbuds in high-traffic areas, such as roads or crosswalks. Doing so may result in accidents due to slowed reaction times.

### Using the Gear IconX earbuds alone

You can listen to music saved in your Gear IconX earbuds. The Gear IconX earbuds also record exercise information.



## Using the Gear IconX earbuds with your mobile device

You can listen to music saved in the connected mobile device and answer incoming calls. You can also view your recorded exercise information via the S Health app on your mobile device.



## Package contents

Check the product box for the following items:

- Earbud (L/R)
- Charging case
- Wingtip (3 sets, S/M/L)
- Earbud tip (3 sets, S/M/L)
- USB cable
- USB connector
- Quick start guide



- The items supplied with the earbuds and any available accessories may vary depending on the region or service provider.
- The supplied items are designed only for this earbuds and may not be compatible with other devices.
- Appearances and specifications are subject to change without prior notice.
- You can purchase additional accessories from the Samsung website. Make sure they are compatible with the earbuds before purchase.
- Use only Samsung-approved accessories. Using unapproved accessories may cause the performance problems and malfunctions that are not covered by the warranty.
- Availability of all accessories is subject to change depending entirely on manufacturing companies. For more information about available accessories, refer to the Samsung website ([www.samsung.com](http://www.samsung.com)).

# Device layout

## Earbud

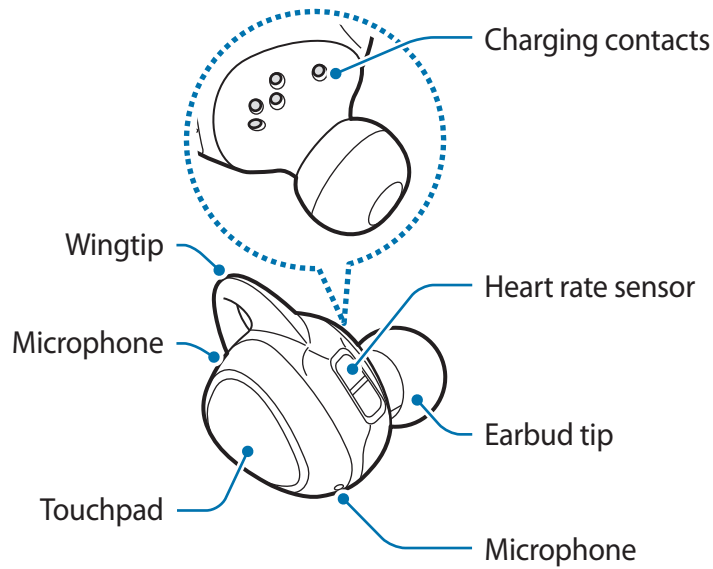

## Charging case

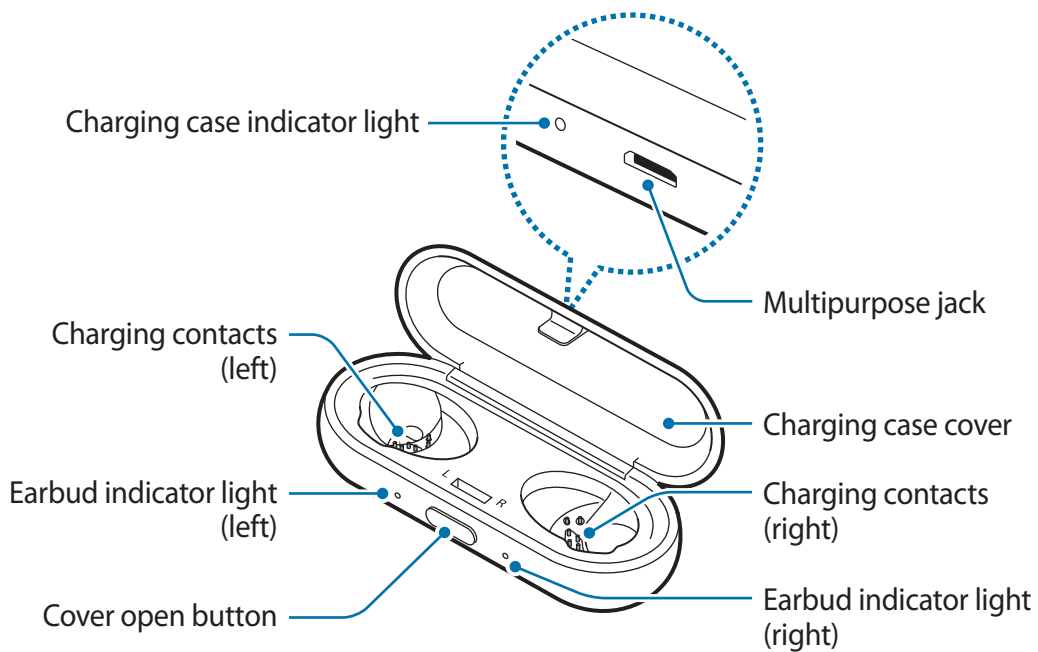



If there is sweat or liquid on the charging contacts, corrosion may occur on the earbuds. Clean the charging contacts and earbuds before storing the earbuds in the charging case.

## Preparing the earbuds for use

### Attaching an earbud tip to the earbud

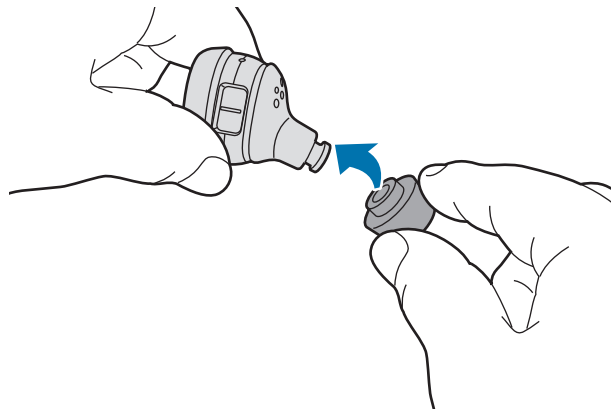
- 1 Select the earbud tip that fits your ear.
- 2 Cover the latch at the bottom of the earbud with the earbud tip.



-  Do not put the earbuds in your ears without earbud tips. Doing so may hurt your ears.
- Do not pull the earbud tip excessively. The earbud tip may tear.

- 3 Follow the same procedure for the other earbud.



## Attaching a wingtip to the earbud

1 Select the wingtip that fits your ear.

2 Select the wingtip for the left or right ear.

3 Cover the earbud with the wingtip.



Do not put the wingtips on the earbuds in the wrong direction. The earbuds will not fit in your ears properly.

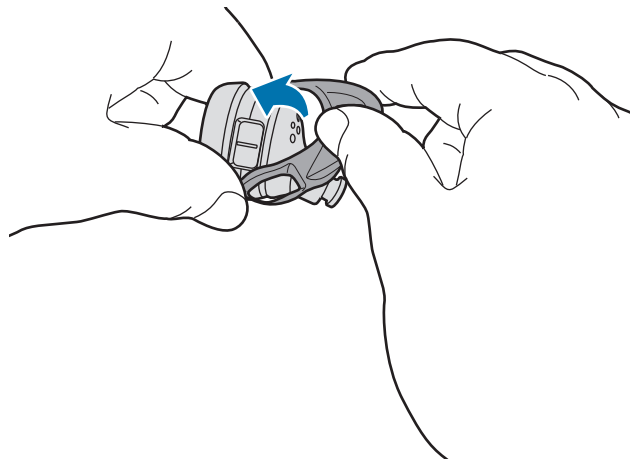

4 Adjust the wingtip so that the heart rate sensor is not blocked.



- Do not put the earbuds in your ears without wingtips. Doing so may hurt your ears.
- Do not pull the wingtip excessively. The wingtip may tear.

5 Follow the same procedure for the other earbud.

# Battery

## Charging the battery

Fully charge the battery before using the earbuds for the first time or when they have been unused for extended periods. Then, the earbuds will power on while charging. When the battery is completely discharged, it needs at least 20 minutes to turn on.

The charging case, which has a built-in battery, is charged along with the earbuds.

You can charge the earbuds by placing them into the charging case without connecting to an electric socket.



Use only Samsung-approved chargers, batteries, and cables. Unapproved chargers or cables can cause the battery to explode or damage the earbuds.



- Chargers are sold separately.
- You cannot use your earbuds' wireless features while charging the battery.
- When there is sweat or liquid on the charging terminal or earbuds, clean them before charging the battery.

- 1 Push the cover open button to open the charging case cover.
- 2 Check the direction of each earbud and insert them into the left and right slots of the charging case.

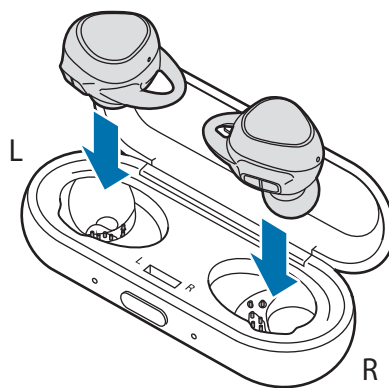

- 3 Close the charging case.

- 4 Connect the USB cable to the USB power adaptor, and then plug the end of the USB cable into the multipurpose jack of the charging case.

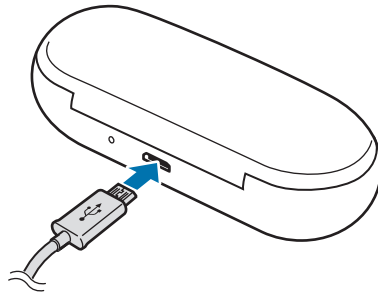

 Connecting the charger improperly may cause serious damage to the charging case. Any damage caused by misuse is not covered by the warranty.

- 5 Plug the USB power adaptor into an electric socket.  
The batteries of the earbuds and the charging case are charged simultaneously.

- 6 After fully charging, disconnect the charging case from the charger. First unplug the charger from the charging case, and then unplug it from the electric socket.

-  • If you do not use the earbuds for an extended period, turn off the earbuds. Refer to [Turning off and restarting the earbuds](#) for more information.
- To save energy, unplug the charger when not in use. The charger does not have a power switch, so you must unplug the charger from the electric socket when not in use to avoid wasting power. The charger should remain close to the electric socket and be easily accessible while charging.

## Reducing the battery consumption

Your earbuds provide two options that help you conserve battery power.

- When you are not using the earbuds, store them in the charging case. The heart rate sensor will continue to work while wearing the earbuds and will reduce the usage time.
- After connecting the earbuds to your mobile device, on the Apps screen, tap **Samsung Gear** → **SETTINGS** → **Notifications**, and tap the switch to activate it. You can reduce the battery consumption by disabling voice notifications except for incoming calls and alarms.

## Battery charging tips and precautions

- If there is sweat or liquid on the charging contacts, corrosion may occur on the contacts. When there is sweat or liquid on the charging terminal or earbuds, clean them before charging the battery.
- Using a power source other than the charger, such as a computer, may result in a slower charging speed due to a lower electric current.
- While charging, the earbuds and the charging case may heat up. This is normal and should not affect the earbuds' lifespan or performance. If the battery gets hotter than usual, the charger may stop charging.
- If the earbuds and charging case are not charging properly, take them with the charger to a Samsung Service Centre.
- Avoid bending the charger. Doing so may damage or reduce the lifespan of the charger. Never use a damaged charger.
- For more information about the battery, such as the usage time, refer to the Samsung website ([www.samsung.com](http://www.samsung.com)).

## Checking the battery level

### Checking via voice guide

When the battery level drops below 10 %, a voice guide will inform you of the battery level. Save your exercise information to your mobile device in advance while you are working out before the battery discharges completely.

### Viewing the battery level from the connected mobile device

Connect the earbuds to your mobile device, open the Apps screen of the mobile device, tap **Samsung Gear** → **INFO**. Then, view the battery status of each earbud on the **Earbuds** card. Refer to [Connecting the earbuds to a mobile device](#) for more information.



- When the remaining battery level is low, a notification will appear on the mobile device's notification panel.
- Before the battery is completely discharged, connect the earbuds with the mobile device and save your exercise information to the mobile device. Then, charge the battery.

## Indicator lights identification

The indicator lights inform you of your earbuds and charging case's charging status.

Two earbud indicator lights are located on the left and right sides of the charging case's open button and show the charging status of each earbud, respectively. The charging case indicator light next to the multipurpose jack indicates the charging status of the case itself.

### Earbud indicator lights

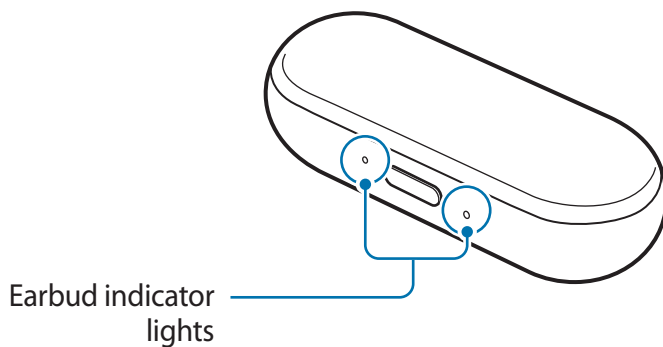

Colour	Status
Continuously on red	<ul style="list-style-type: none"> <li>• Charging</li> </ul>
Continuously on green	<ul style="list-style-type: none"> <li>• Fully charged</li> </ul>
Flashes red (rapid pace)	<ul style="list-style-type: none"> <li>• Charging disabled due to abnormal temperatures</li> </ul>
Flashes red (medium pace)	<ul style="list-style-type: none"> <li>• Charging disabled due to an error in connecting with charging contacts</li> <li>• Charging disabled due to low charging case battery</li> </ul>
Flashes red in turn	<ul style="list-style-type: none"> <li>• Earbud error</li> </ul>

## Charging case indicator light

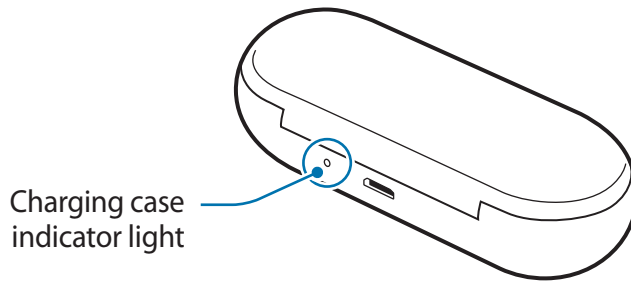

Colour	Status
Continuously on red	• Charging
Continuously on green	• Fully charged
Flashes red (rapid pace)	• Charging blocked due to abnormal temperatures
Flashes red (slow pace)	• Low battery



- If power is lost, the indicator lights will flash red about for 30 seconds and turn off.
- If the indicator lights do not work as described, disconnect the charger from the charging case and reconnect it.

# Using the earbuds

## Activating the earbuds

Before using the earbuds for the first time, you need to activate them.



- When the charging case indicator light slowly flashes red, it needs to be charged for at least 20 minutes.
- To enter Bluetooth pairing mode, insert the earbuds into the charging case. Then, take out the earbuds and put them in your ears.

- 1 Push the cover open button to open the charging case cover.
- 2 Check the direction of each earbud and insert them into the left and right slots of the charging case.

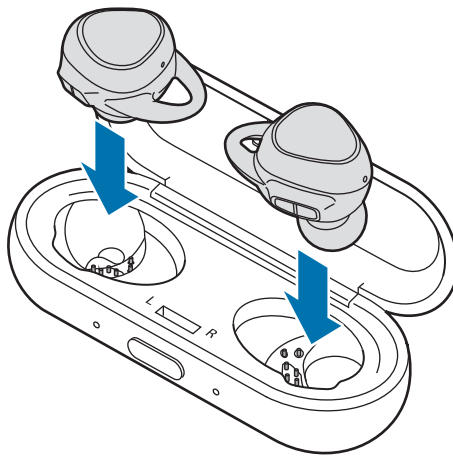

- 3 Close the charging case.



**4** Remove the earbuds from the charging case.

The earbuds will be activated.

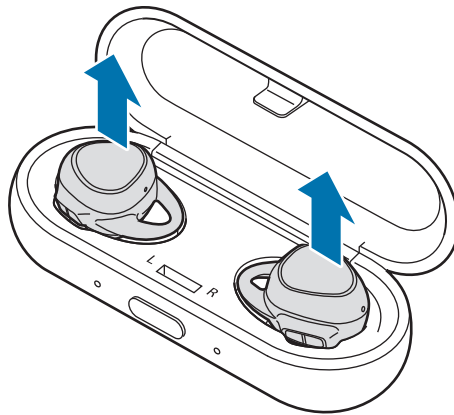

## Wearing the earbuds correctly

Before wearing the earbuds, make sure to attach the earbud tips and wingtips to the earbuds.

- 1** Check the direction of each earbud and put them in your ears with the wingtip facing upwards until they sit conformably in your ears.

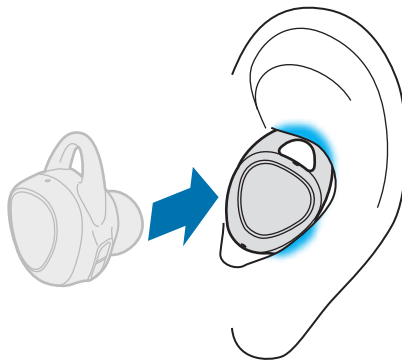

Do not touch the heart rate sensor while you are putting an earbud in your ear. If the heart rate sensor comes into contact with your skin before wearing the earbud, it may not function properly.

## 2 Adjust the earbuds by rotating them to the left or right to fit your ears.

The heart rate sensor will automatically detect that you are wearing the earbuds when you put them on. Then, the earbuds will automatically enter Bluetooth pairing mode and emit a sound.



- If the heart rate sensor does not make contact with your ear, the earbud may not work. Use the wingtips and earbud tips that fit your ears.
- Follow all posted warnings and directions from authorized personnel in areas, such as aeroplanes and hospitals.

# Connecting the earbuds to a mobile device

## Installing the Samsung Gear app

To connect your earbuds to a mobile device, install the Samsung Gear app on the mobile device. Depending on your device, you can download the Samsung Gear app from the following places:

- Samsung Android devices: **Galaxy Apps** or [apps.samsung.com/gear](https://apps.samsung.com/gear)
- Other Android devices: **Play Store** or [apps.samsung.com/gear](https://apps.samsung.com/gear)



- You can download the Samsung Gear app only on mobile devices running Android operating system 4.4 (API 19) or later, and with 1.5 GB of RAM or more. Visit [www.samsung.com](https://www.samsung.com) to see a list of compatible mobile devices.
- You can change the language of the Samsung Gear app on your connected mobile device. On your mobile device's Home screen, tap **Apps** → **Settings** → **Language and input** → **Language**. English may appear if the selected language on the Settings screen is not supported on the Samsung Gear app.

## Connecting to a mobile device via Bluetooth

### Earbuds

- 1 Insert the earbuds into the charging case, close it, and then take out the earbuds.
- 2 Put the earbuds in your ears to enter Bluetooth pairing mode.



If the earbuds do not connect to a mobile device within three minutes, Bluetooth pairing mode will be deactivated. To enter Bluetooth pairing mode again, insert the earbuds into the charging case and close it. Then, take out the earbuds and put them in your ears.

### Mobile device

- 3 On your mobile device's Apps screen, tap **Samsung Gear**.  
If necessary, update the Samsung Gear app to the latest version.

- 4 Tap **CONNECT TO GEAR**.

- 5 Tap **Gear IconX R (0000)**.

- 6 Follow the on-screen instructions to complete the connection.

You will hear "Connected" with a notification sound on the main earbud. Only the main earbud used for calls and recording exercise information will be connected with the mobile device. The other earbud will be connected to the main earbud. Refer to [Coupling the two earbuds](#) for more information.

Once the earbuds are connected with your mobile device, they will automatically attempt to connect to the mobile device whenever you put them in your ears.



- If the Bluetooth connection fails or the mobile device cannot scan the earbuds, unpair devices that were previously paired with your mobile device. Then, try to connect again.
- Connection methods may vary depending on your device and software version.

## Notices for using Bluetooth

Bluetooth is a wireless technology standard that uses a 2.4 GHz frequency to connect to various devices over short distances. It can connect and exchange data with other Bluetooth enabled devices, such as mobile devices, without connecting via cables.

- To avoid problems when connecting your earbuds to another device, place the devices close to each other.
- Ensure that your earbuds and the other Bluetooth device are within the Bluetooth connection range (5 m). The distance may vary depending on the environment the devices are used in.
- Ensure that there are no obstacles between the earbuds and a connected device, including human bodies, walls, corners, or fences.
- Do not touch the Bluetooth antenna of a connected device.
- Bluetooth uses the same frequency as some industrial, scientific, medical, and low power products and interference may occur when making connections near these types of products.
- Some devices, especially those that are not tested or approved by the Bluetooth SIG, may be incompatible with the earbuds.
- Do not use the Bluetooth feature for illegal purposes (for example, pirating copies of files or illegally tapping communications for commercial purposes).

## Using the earbuds without a mobile device

You can use the earbuds without connecting them to a mobile device. Some features like receiving call or saving exercise information are not available. If you want to save your exercise information, connect the earbuds with your mobile device after finishing workout. Refer to [Connecting the earbuds to a mobile device](#) for more information.

## Coupling the two earbuds

When you put both earbuds in your ears, they will automatically couple and emit a sound in turn. Once coupled, they will be automatically connected in the future.



- If the main earbud comes out of your ear, the earbuds and the mobile device will be disconnected. Refer to [Setting the main earbud](#) for more information about the main earbud.
- If an earbud comes out of your ear, the coupling between the two earbuds is disconnected.
- When the coupling is disconnected, remove both earbuds from your ears and wear them again. The coupling is automatically recovered. If the coupling is not recovered, ensure that you wear the earbuds correctly.
- If you lose an earbud, you may have a problem using some earbuds' features. For purchase enquiries, visit a Samsung Service Centre.
- If you replace a lost earbud, place the earbuds in the charging case and connect the case to your computer. Then, use Gear IconX PC Manager to pair the two earbuds.

## Setting the main earbud

Set the main earbud to use the call feature and to record exercise information. The right earbud is preset as the main earbud.

- 1 On the Apps screen of the mobile device, tap **Samsung Gear**.
- 2 Tap **SETTINGS** → **Select main earbud**, tap the right or the left earbud, and then tap **OK**.  
You can also select the main earbud from the **Earbuds** card in **INFO**.



- After you change the main earbud, the earbuds may not automatically reconnect to your mobile device. If this happens, on your mobile device's Home screen, tap **Apps** → **Settings** → **Bluetooth**, and then search for the earbuds and connect the device manually.
- If you change the main earbud while working out, the exercise information will not be saved in the new main earbud. When you are working out, you must complete the exercise and save the exercise information before changing the main earbud.
- In Gear IconX PC Manager, click **More** → **Device settings**, and select **Right** or **Left** to specify the main earbud. First, install Gear IconX PC Manager on your computer. Refer to [Gear IconX PC Manager](#) for more information.
- You must manually search for the earbuds and reconnect them to your device when you change the main earbud via Gear IconX PC Manager.

## Using the touchpad

You can control music playback and answer or reject calls with the touchpad.

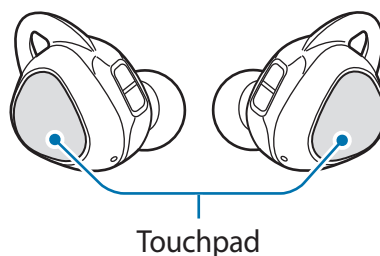

- To avoid hurting your ears, do not apply excessive pressure to the touchpad with your fingertips.
- To avoid damaging the touchpad, do not tap it with anything sharp.



The direction in which you wear the earbuds will affect the direction of your drag on the touchpad. Wear the earbuds correctly. Refer to [Wearing the earbuds correctly](#) for more information.



### Single tap

- Play or pause track.



### Double tap

- Play next track.
- Answer or end a call.
- Place the current call on hold and answer the second call.
- Switch between the current call and the held call.



### Triple tap

- Play previous track.
  - If you triple-tap three seconds after a track begins playing, it will start the track from beginning. Triple-tap the touchpad within three seconds of when a track begins playing to play the previous track.



### Tap and hold

- Decline call.
- The microphone on or off during a call.
  - This will not display anything on the mobile device.
- Retrieve a held call after ending a current call.
- Read out menu options.

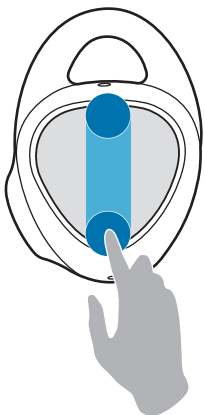

### Swipe up/down

- Volume up/down.

## Reading the menu options

- 1 Tap and hold the touchpad to read the menu options.
- 2 Release your finger to activate the feature when you hear the menu option you want to use.

The readout menu options are different based on your current exercise status.

- Before exercising: Start workout → Enable ambient sound / Disable ambient sound
- While exercising: Finish workout → Workout details → Enable ambient sound / Disable ambient sound



If you fail to activate the feature, tap and hold the touchpad again to read the menu options again.

## Transferring music files to the earbuds

### Transferring music files from your mobile device

Transfer music files from your mobile device to your earbuds via the Samsung Gear app on your mobile device.



- Transferring music may not be available depending on the mobile device.
- Music files which are not transferred via the Samsung Gear app may not be played.
- The earbuds support the MP3, M4A, AAC, WAV, WMA(WMA v9) file formats.
- Music files in the playlist are sorted alphabetically.
- The earbuds will play only the first to the 1,000th file in the playlist.
- The same music files may not be saved in both earbuds when you transfer the music files manually without using the Samsung Gear app. If the music files in each earbud are different, they may not play.



1 Insert the earbuds into the charging case and close the charging case cover.



If one of the earbuds does not touch the case's charging contact, Gear IconX PC Manager will not recognise the earbuds.

2 Plug the USB connector into the multipurpose jack of your mobile device. Connect the charging case and the mobile device using the USB cable.

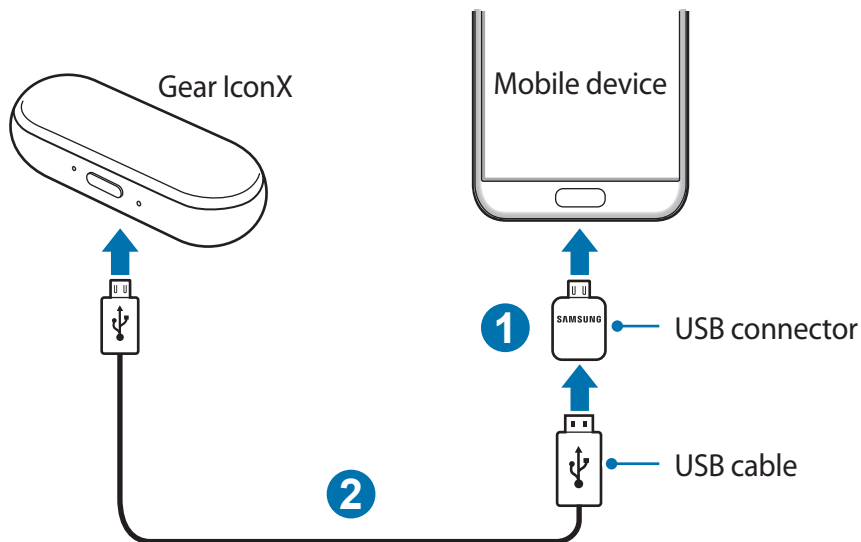

- You must plug the USB connector into your mobile device. If you do plug the USB connector into the charging case, you cannot transfer your music files to the earbuds. If your mobile device does not support the USB connector, you cannot transfer music files to the earbuds.
- Transferring data with the USB connector increases the battery power consumption. Ensure that the battery is fully charged before transferring data. If the battery power is low, data transfer may be interrupted.
- If the USB connector provided with the earbuds is not compatible with your mobile device, use the compatible USB connector with your mobile device.

3 On your mobile device's Apps screen, tap **Samsung Gear**.

4 Tap **SETTINGS** → **Music** or tap **INFO** → **MUSIC SETTINGS** on **Music on Gear IconX** card, and tap **Manage tracks**.

5 Select the category, and tick music files to transfer and tap **ADD**.

Music files are saved in the MUSIC folder of the earbuds. Do not change the folder name or create a new folder. If you make any changes to the file directory of the earbuds, the music files may not play.



Do not disconnect the USB cable or USB connector from the earbuds or mobile device when you are transferring files. Doing so may cause data loss or device damage.

## Transferring music files from your computer

Transfer music files from your computer to your earbuds via the Gear IconX PC Manager on your computer. Transfer music files from your computer to the earbuds using the earbuds as a removable disk for data transfer.



- Music files which are not transferred via the Gear IconX PC Manager may not be played.
- The same music files may not be saved in both earbuds when you transfer the music files manually without using the Gear IconX PC Manager. If the music files in each earbud are different, they may not play.

## Connecting the earbuds with the computer

To connect the earbuds to your computer, you must install Gear IconX PC Manager on your computer. Refer to [Installing Gear IconX PC Manager](#) for more information.

## Transferring music files from your computer

1 Insert the earbuds into the charging case and close the charging case cover.



If any one of the earbuds does not make contacts with the charging contacts, the Gear IconX PC Manager will not recognise the earbuds.

2 Connect the charging case and the computer using the USB cable.

3 In the computer, run **Gear IconX** and click **Add new tracks**.



When the software update pop-up window appears, tap **Update** to update it to the latest version if necessary. If the pop-up window does not appear, tap **More** → **About PC software** → **Update** to view Gear IconX PC Manager's version information and update it.

4 Select music files to transfer and click **Open**.

Music files are saved in the MUSIC folder of the earbuds. Do not change the folder name or create a new folder. If you make any changes to the file directory of the earbuds, the music files may not play.



Do not disconnect the USB cable from the earbuds or computer when you are transferring files. Doing so may cause data loss or device damage.

## Syncing data between earbuds

Sync the earbuds so that they have the same music files when you manually transfer music files without using the Samsung Gear app or the Gear IconX PC Manager.

1 Insert the earbuds into the charging case and close the charging case cover.



If one of the earbuds does not touch with the charging case's contact, Gear IconX PC Manager will not recognise the earbuds.

- 2 Connect the charging case and the computer via the USB cable.
- 3 On your computer's desktop, click **Gear IconX** → **More** → **Balance earbud data**.  
The music files are automatically stored in both earbuds.



Only the data in the main earbud can be synced. The data in the other earbud cannot be synced.

## Listening to music

### Playing music files saved in the earbuds

Listen to music saved in the earbuds without connecting them to your mobile device. Tap the touchpad to play music.

### Playing or pausing the track

Tap the touchpad to play and pause the track.

### Playing the next track

Double-tap the touchpad to play the next track during playback.

### Playing the previous track

Tap the touchpad three times to play the previous track during playback.



If you triple-tap three seconds after a track begins playing, it will start the track from beginning. Triple-tap the touchpad within three seconds of when a track begins playing to play the previous track.

## Adjusting the volume

Drag your finger upwards or downwards on the touchpad to adjust the volume during playback.



If using the earbuds alone, the earbuds will emit a sound when the volume is near the maximum level. Reduce the volume, even if you can turn up the volume more, to prevent the hearing damage.

## Playing music files saved in your mobile device

Listen to music saved in your mobile device by connecting the earbuds to the mobile device. You can stream music played from the connected mobile device without saving music files in the earbuds.

- 1 On the Apps screen of the mobile device, tap **Samsung Gear**.
- 2 Tap **SETTINGS** → **Music** or tap **INFO** → **MUSIC SETTINGS** on **Music on Gear IconX** card, and tap **Play music from**.
- 3 Tap **phone** to play music from your mobile device.
- 4 Launch a music player app and play music.

You can control the playback in the same way as when playing music saved in the earbuds.



- Adjust the volume via your connected device if a sound is low on your earbuds while at full volume.
- If you connect the earbuds to your mobile device while listening to music, the volume may change.

## Recording exercise information

### Starting a workout

Record and save exercise information, such as the activity duration, your heart rate, and the number of calories you burnt, without connecting the earbuds to your mobile device.

- 1 Put both earbuds in your ears.  
You will hear a sound informing that you are wearing the earbuds.
- 2 Tap and hold the touchpad and release it when you hear “Start workout”.
- 3 When you hear “Workout started” followed by four beeps, stay still until the voice guide is complete and then start your workout.
  - To check the status of your workout, tap and hold the touchpad and release it when you hear “Workout details”. Then, you will hear the recorded exercise information. On your mobile device’s Apps screen, tap **Samsung Gear** → **SETTINGS** → **Exercise audio guide** → **Guide information**. Select the voice guide for duration, distance, heart rate, calories, and speed.
  - To hear your surroundings during your workout, tap and hold the touchpad and release it when you hear “Enable ambient sound”. Then, you will hear “Ambient sound enabled”.
  - If the heart rate sensor does not make contact with your ear, the earbuds may stop working. Remove the earbuds from your ears and put them in your ears again within 20 minutes. When you hear “Workout resumed”, stay still until the voice guide is complete and then continue your workout.
- 4 When you have finished your workout, tap and hold the touchpad and release it when you hear “Finish workout”.

You will hear your workout results. You can also view the type of workout and the workout duration via your connected mobile device’s Samsung Gear app or S Health app.



You can hear the workout type, total activity duration, and total activity distance after finishing your workout. The earbuds recognise your speed automatically while you are exercising and save the workout type as walking or running.

## Starting a workout with the earbuds connected to your mobile device

When you work out with the earbuds connected to your mobile device's exercise apps, you can check your heart rate in real time. You can also check the details and history of your exercise information on the S Health app of the connected mobile device.



If you already started a workout from the earbuds, you cannot control your workout session via the mobile device's S Health app. End the current session by tapping and holding the touchpad and releasing it when you hear "Finish workout".

**1** Connect the earbuds to your mobile device. Refer to [Connecting the earbuds to a mobile device](#) for more information.

**2** On the Apps screen of the mobile device, tap **S Health**.

The Gear IconX is automatically added to the S Health app's accessories list.

**3** In the S Health app, tap **START** on the activity tracker.

The 3-second countdown timer will start. When the timer reaches "0", start your workout.

- If the distance between the earbuds and the mobile device is more than 5 m, the earbuds and the mobile device will disconnect and a voice guide will say "Disconnected". To resume your workout, bring the devices within 5 m of each other. When you hear "Connected", and then "Workout resumed", stay still until the voice guide is complete and then continue your workout.

**4** When you have finished your workout, tap **PAUSE** → **STOP** on the activity tracker.

The earbuds will stop recording exercise information and the workout result is displayed.



The profile and the distance unit set in the S Health app will be used for the earbuds and Samsung Gear app. If S Health is not up to date, it may not connect to the earbuds. Check S Health's version information and update to the latest version.

## Additional information

- S Health is intended for fitness and wellness purposes only and is not intended for use in the diagnosis of disease or other conditions, or in the cure, mitigation, treatment, or prevention of disease.
- The available functions, features and addable applications for S Health may vary from country to country due to different local laws and regulations. You should check the features and applications available in your specific region before use.
- S Health applications and its service can be changed or discontinued without prior notice.
- The purpose for such data collection is limited to providing the service that you have requested, including providing additional information to enhance your wellness, back up/sync data, data analysis and statistics or to develop and provide better services. (But if you sign in to your Samsung account from S Health, your data may be saved on the server for data backup purposes.) Personal information may be stored until the completion of such purposes. To delete any data you have shared with social networks or transferred to storage devices, you must delete them separately.
- You assume full responsibility for the inappropriate use of data shared on social networks or transmitted to others. Use caution when sharing your personal data with others.
- If the earbuds are connected to a mobile device, verify the communication protocol to confirm proper operation. If you use a wireless connection, such as Bluetooth, the earbuds may be affected by electronic interference from other devices. Avoid using the earbuds near other devices that transmit radio waves.
- Please read Terms and Conditions and Privacy Policy of S Health carefully before using it.
- Measured distance may differ from the actual distance due to uneven strides, walking in place, and pacing around.
- Only records from the past 30 days are saved. You can view previous data on the mobile device where the S Health app is installed.



## Measuring your heart rate during a workout

When you work out while wearing the earbuds, you can check and record your heart rate in real time while using S Health or other exercise apps.



- This feature is intended for fitness and informational purposes only and is not intended for use in the diagnosis of disease or other conditions, or in the cure, mitigation, treatment, or prevention of disease.
- To measure your heart rate more accurately with the earbuds, wear the earbuds firmly in your ears. Refer to [Wearing the earbuds correctly](#) for more information.

### Be aware of following conditions before measuring your heart rate:

The Gear IconX can measure your heart rate only when you are working out. It does not allow you to measure your heart rate in other circumstances.

- The accuracy of the heart rate sensor may be diminished if the heart rate sensor does not make contact with your ear.
- Use the HR feature only for measuring your heart rate.
- Do not look directly at the heart rate sensor's lights. Doing so may impair your vision. Make sure children do not look directly at the lights.
- The amount of time required for the heart rate sensor to measure your heart rate may vary depending on measurement conditions and surroundings.
- Cold ambient temperatures may affect your measurement; during winter or cold weather, keep yourself warm when checking your heart rate.
- If heart rate measurement is not working properly, adjust the position of the earbuds so the heart rate sensor sits firmly against the insides of your ears. For example, rotate the earbuds slightly to the right, left, up, or down, and try measuring again. If that does not work, change the wingtip size and try measuring again.
- Measure your heart rate repeatedly at least five times and check the average value.
- Smoking or consuming alcohol before taking measurements may cause your heart rate to be different from your normal heart rate.
- Do not talk, yawn, or breathe deeply while taking heart rate measurements. Doing so may cause your heart rate to be recorded inaccurately.

- Because the heart rate sensor uses light to approximate heart rate, its accuracy may vary due to physical factors that affect light absorption and reflection, such as blood circulation/blood pressure, skin condition and location and concentration of blood vessels.
- If obstructions between the heart rate sensor and your ear, such as body hair, dirt, or other objects, prevent the light from reflecting evenly, measurements may be inaccurate.
- The accuracy of the heart rate sensor may be diminished when you are trying to measure infants' heart rates.
- If the heart rate sensor is dirty, clean it before use.
- If the heart rate sensor is damaged, measurements may be inaccurate.
- If your earbuds become hot to the touch, stop measuring and remove them from your ears. Extended exposure of skin to hot earbuds can result in burns.

## Using call features

When the earbuds are connected to a mobile device, you can answer and control calls from the connected mobile device.

### Answering or declining a call

When a call comes in while you are wearing the earbuds, they will emit a sound.

To answer the call, double-tap the touchpad.

To decline the call, tap and hold the touchpad.



You can hear the other party's voice only via the main earbud.

### Adjusting the volume

Drag your finger upwards or downwards on the touchpad to adjust the volume during a call.

## Answering a second call

When a second call comes in during a call, the earbuds will emit a sound.

To end the current call and answer the second call, tap and hold the touchpad.

To place the current call on hold and answer the second call, double-tap the touchpad.

To switch between the current call and the held call, double-tap the touchpad.

## Turning off the microphone

Tap and hold the touchpad to turn off the microphone so that the other party cannot hear you.

## Ending a call

Double-tap the touchpad to end the current call.

# Using ambient sound mode

Hear your surroundings while you are listening to music outdoors, so you can quickly detect any potentially dangerous situations.

Tap and hold the touchpad and release it when you hear "Enable ambient sound". Then, you will hear "Ambient sound enabled" and the feature will be activated.



- The feature will only be activated when you put both earbuds in your ears.
- You can activate or deactivate this feature via the connected mobile device. Refer to [Ambient sound](#) for more information.
- During a call, ambient sound mode turns off automatically. After the call, the mode returns to the previous state.
- In ambient sound mode, feedback may occur when adjusting the volume or touching the microphone.
- In ambient sound mode, you can still hear loud external sounds.

# Samsung Gear and Gear IconX PC Manager

## Samsung Gear

### Samsung Gear introduction

To connect the earbuds to a mobile device, you must install the Samsung Gear app on your mobile device. Using the Samsung Gear app, you can customise your earbud settings.

Tap **Samsung Gear** on the Apps screen of the mobile device.

If it is the first time connecting the earbuds and a mobile device, refer to [Connecting the earbuds to a mobile device](#) for more information.

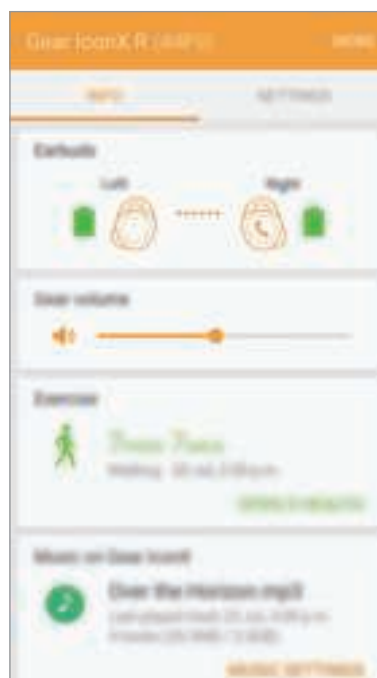

Some features may not be available depending on the type of connected mobile device.

## Disconnecting devices from the earbuds

Remove the earbuds from your ears to end the current connection. The Bluetooth connection will end after five seconds.



If the earbuds are removed during a call, the Bluetooth connection will end immediately. If the earbuds are removed during a workout, the Bluetooth connection will end after 10 seconds. The exercise information saved in the earbuds will be sent to mobile device in 10 seconds before ending the connection.

To manually disconnect the earbuds from your mobile device, put the earbuds in your ears, open the Apps screen of the mobile device, tap **Samsung Gear** → **MORE** → **Disconnect**. Or, on your mobile device's Setting screen, tap **Bluetooth** and unpair the earbuds and your mobile device.



The earbuds do not have a power-on/off function. If the earbuds are not used for a predefined length of time after removed from your ears, the earbuds will enter sleep mode and the mobile device will be disconnected. To enter Bluetooth pairing mode again, insert the earbuds into the charging case and close it. Then, put the earbuds in your ears.

## Reconnecting devices and the earbuds

Once the earbuds are paired with your mobile device, they will automatically attempt to connect to the mobile device whenever you put them in your ears.

To manually reconnect the earbuds to your mobile device, open the Apps screen of the mobile device and tap **Samsung Gear** → **MORE** → **Connect**.

## Connecting with new earbuds

You can disconnect the earbuds from your mobile device and connect new ones.

On the Apps screen of the mobile device, tap **Samsung Gear** → **MORE** → **Connect new Gear**.

## Connecting with other devices

On the Apps screen of your mobile device, tap **Samsung Gear** → **MORE** → **Disconnect**. Or, on the Setting screen of your mobile device, tap **Bluetooth** and unpair the earbuds and your mobile device.

The Bluetooth connection between the earbuds and previous mobile device will end.

After disconnecting earbuds from the previous mobile device, you can connect the earbuds with other mobile device.

Refer to [Connecting the earbuds to a mobile device](#) for more information.

## Viewing earbud status

View and customise the status of the earbuds connected to your mobile device.

On the Apps screen of the mobile device, tap **Samsung Gear** → **INFO**.

- **Tips:** Check the quick guide for using the earbuds. Tap **LET'S GO** to read tips or tap **X** to delete the card.
- **Earbuds:** View the connection status and the remaining battery level of the earbuds. You can also set one of the earbuds as the main earbud.
- **Gear volume:** Check and adjust the earbud volume.
- **Exercise:** View your exercise information detected by the earbuds.
- **Music on Gear IconX:** View the file name of the currently playing music or tap **MUSIC SETTINGS** to change the music playback settings. Also, view the earbud's storage capacity and the number of music files saved in the earbuds.



The actual available capacity of the earbud may differ from the capacity displayed on the Samsung Gear app. The available capacity may change when you update the app.

## Customising settings

View and customise the settings of the earbuds connected to your mobile device.

On the Apps screen of the mobile device, tap **Samsung Gear** → **SETTINGS**.

### Music

- **Manage tracks:** Transfer music files from your mobile device to the earbuds. Refer to [Transferring music files to the earbuds](#) for more information.
- **Shuffle:** Turn shuffle on or off.
- **Music control feedback:** Select **Voice** or **Beeping** for the feedback type you hear when you touch the touchpad to control music playback.
- **Play music from:** Select whether to play music from the earbuds or your mobile device. If you play music from the earbuds, you will not hear music or the S Health app's voice guide from your mobile device.

### Notifications

You will receive notifications from the mobile device's apps via the earbuds. Even if you deactivate notifications, you will still receive notifications for incoming calls and alarms.

- **Manage notifications:** Select the apps you want to receive notifications from and change the notification settings for each app.
- **Limit notifications:** When the earbuds are connected to your mobile device, you can set the earbuds to limit notifications from the mobile device. Even if you activate this feature, alarm and call notifications will be forwarded to the earbuds.

### Exercise audio guide

Activate the audio guide to hear exercise information during your workout, and select an interval for the audio guide messages. If you want to use this feature, tap the switch to activate it.

- **Interval:** Select an interval at which to hear the audio guide messages.
- **Guide information:** Select which information to receive via the audio guide.



If the heart rate sensor does not make contact with your ear, this feature may not work properly.

## Ambient sound

Hear your surroundings while you are listening to music outdoors, so you can quickly detect any potentially dangerous situations.

## Read out menu options

Set the readout menu options through the earbuds. You can select the menu items to use or reorder them.

## Voice guide language

Select the language for the voice feedback you receive from the earbuds.



The voice guide supports 15 languages. English may be used if the language selected on the Settings screen is not supported.

## Select main earbud

Set an earbud as the main earbud to be used for answering calls and recording exercise information. The right earbud is preset as the main earbud.

## About Gear IconX

View the device information of the earbuds, change the device name, and update the software. If you experience a problem while using the earbuds, such as an unresponsive touchpad, or when you want to connect the earbuds to a new mobile device, you can reset the earbuds. Tap **Reset Gear** and follow the on-screen instructions to complete the reset.

## App version

View the Samsung Gear app's version information. If necessary, tap **Updates available** to update the Samsung Gear app to the latest version.



## Gear IconX PC Manager

### Installing Gear IconX PC Manager

To connect the earbuds to a computer, you must install Gear IconX PC Manager on your computer.

- 1 Insert the earbuds into the charging case and close the charging case cover.
- 2 Connect the charging case with the computer using the USB cable.
- 3 On your computer's desktop, click  → **Computer**.
- 4 Open **IconX\_R** or **IconX\_L** → **TOOLS**, and then double-click the Gear IconX PC Manager installation file.
- 5 Follow the on-screen instructions to complete the installation.



You can also download Gear IconX PC Manager from the Samsung website ([www.samsung.com](http://www.samsung.com)).

## Gear IconX PC Manager introduction

You can customise your earbud settings with Gear IconX PC Manager.



If you replace a lost earbud, place the earbuds in the charging case and connect the case to your computer. Then, use Gear IconX PC Manager to pair the two earbuds.

Insert the earbuds into the charging case and connect the case to your computer. Then, tap **Gear IconX** → **More**.

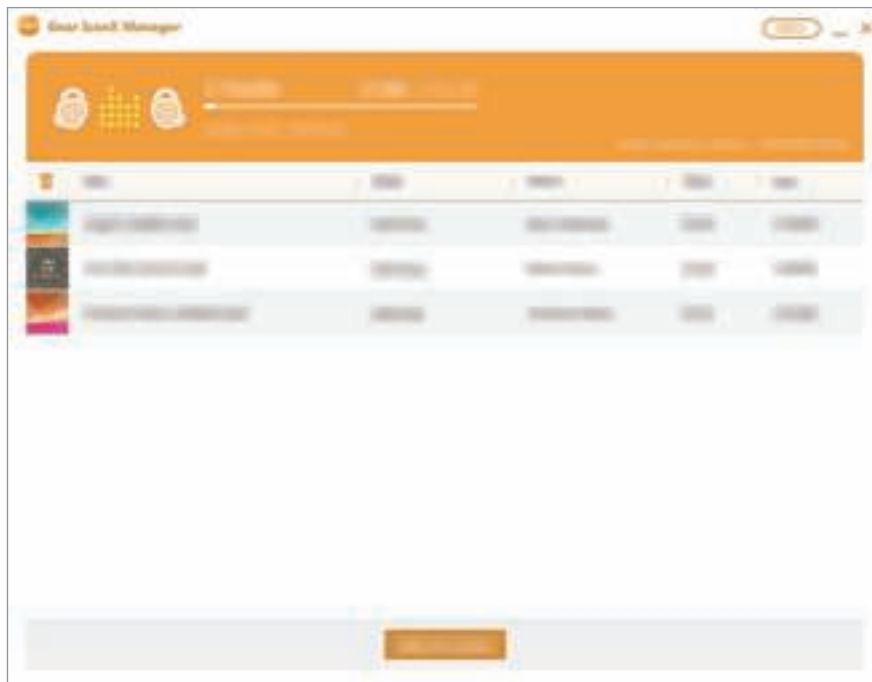

### Device settings

Set an earbud as the main earbud to be used for answering calls and recording exercise information. The right earbud is preset as the main earbud.

### About PC software

View the Gear IconX PC Manager's version information. If necessary, tap **Update** to update Gear IconX PC Manager to the latest version.

### Balance earbud data

Tap **Balance earbud data** to store the music in both earbuds automatically when you manually transfer the music files to your mobile device.

# Appendix

## Troubleshooting

Before contacting a Samsung Service Centre, please attempt the following solutions. Some situations may not apply to your earbuds.

### Your earbuds do not work

- The battery may be completely discharged. Charge the battery completely before using the earbuds.
- If an earbud's heart rate sensor does not make contact with your ear, the earbud may not work. If you do not hear a sound informing you that the earbuds are detected, remove the earbuds from your ears and put them in again.

### Another Bluetooth device cannot locate your earbuds

- When you wear the earbuds, listen for the beep to ensure that your earbuds have entered Bluetooth pairing mode.
- Insert the earbuds into the charging case, take them out, and put them in your ears.
- Ensure that your earbuds and the other Bluetooth device are within the Bluetooth connection range (5 m). The distance may vary depending on the environment the devices are used in.

If the tips above do not solve the problem, contact a Samsung Service Centre.

## **A Bluetooth connection is not established or your earbuds and the mobile device are disconnected**

- Ensure there are no obstacles, such as walls or electrical equipment, between the devices.
- Ensure that the latest version of the Samsung Gear app is installed on the mobile device. If necessary, update the Samsung Gear app to the latest version.
- Ensure that your earbuds and the other Bluetooth device are within the Bluetooth connection range (5 m). The distance may vary depending on the environment the devices are used in.
- Restart the mobile device and relaunch the Samsung Gear app.

## **The coupling fails**

Inserting the earbuds into the charging case and wear them again. If you cannot still solve the problem, place the earbuds in the charging case and connect the case to your computer. Then, use Gear IconX PC Manager to pair the two earbuds.

## **The battery does not charge properly (For Samsung-approved chargers)**

- Ensure that the charging contacts of the earbuds and the charging case are in contact with each other.
- Ensure that the charger is connected properly.
- If the battery contacts are dirty, the battery may not charge properly. Wipe both gold-coloured contacts and try charging the battery again.
- Visit a Samsung Service Centre and have the battery replaced.

## **The charging time and the battery life is different between the earbuds**

- The main earbud's battery life will be less than the other earbud because it operates more features.
- The main earbud takes longer to charge than the other one.

## The battery depletes faster than when first purchased

- When you expose the earbuds or the battery to very cold or very hot temperatures, the useful charge may be reduced.
- The battery is consumable and the useful charge will get shorter over time.

## You cannot hear others speaking

- Adjust the earbud volume.
- Adjust the volume on the connected device when you cannot hear sounds on your earbuds at full volume.

## Sound echoes during a call

Adjust the volume by dragging your finger upwards or downwards on the touchpad, or move to another area.

## Audio quality is poor

- Wireless network services may be disabled due to issues with the service provider's network. Ensure to keep the earbuds away from electromagnetic waves.
- Ensure that your earbuds and the other Bluetooth device are within the maximum Bluetooth range (5 m). The distance may vary depending on the environment the devices are used in.
- You may experience drops in volume or noise depending on the connected device's volume. To avoid this, appropriately adjust the connected device's sound.

## Your earbuds are hot to the touch

When you use the earbuds for an extended period of time, it may feel hot to the touch. This is normal and should not affect your earbuds' lifespan or performance.

If the earbuds overheat or feel hot for a prolonged period, do not use them for a while. If the earbuds continue to overheat, contact a Samsung Service Centre.

## A small gap appears around the outside of the earbud case

- This gap is a necessary manufacturing feature and some minor rocking or vibration of parts may occur.
- Over time, friction between parts may cause this gap to expand slightly.

## Turning off and restarting the earbuds

If you do not use the earbuds for an extended period, turn off the earbuds. If the touchpad becomes unresponsive or the earbuds do not work properly, turn off and restart the earbuds.

- 1 Remove the wingtip from an earbud. Then, use a paper clip to press and hold the Restart button above the heart rate sensor for more than six seconds.

The earbuds will be deactivated.

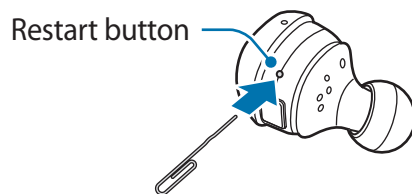

- 2 Follow the same procedure for the other earbud to turn off it.

- 3 Press and hold the Restart button again.

The earbud will restart after the heart rate sensor flashes three times.

- 4 Follow the same procedure for the other earbud to restart it.



You can also restart the earbuds by inserting the earbuds in the charging case, closing the charging case cover, and then removing the earbuds from the case.

## Removing the battery

- To remove the battery, you **must** visit an authorised service centre with the provided instructions.
- For your safety, you **must not attempt to remove** the battery. If the battery is not properly removed, it may lead to damage to the battery and device, cause personal injury, and/or result in the device being unsafe.
- Samsung does not accept liability for any damage or loss (whether in contract or tort, including negligence) which may arise from failure to precisely follow these warnings and instructions, other than death or personal injury caused by Samsung's negligence.

- 1 Remove the wingtip and earbud tip from the earbud.
- 2 Remove the touchpad using a flat-edged tool.
- 3 Desolder the circuit board using a soldering iron, then remove it out of the battery bracket.
- 4 Remove the battery.

## Copyright

Copyright © 2016 Samsung Electronics

This manual is protected under international copyright laws.

No part of this manual may be reproduced, distributed, translated, or transmitted in any form or by any means, electronic or mechanical, including photocopying, recording, or storing in any information storage and retrieval system, without the prior written permission of Samsung Electronics.

## Trademarks

- SAMSUNG and the SAMSUNG logo are registered trademarks of Samsung Electronics.
- Bluetooth® is a registered trademark of Bluetooth SIG, Inc. worldwide.



- All other trademarks and copyrights are the property of their respective owners.

Model: SM-R150

Rated voltage/current: 5 V / 50 mA

FCC ID: ASLSM-R150

Made in Vietnam by Samsung

Samsung, GU46, 6GG, UK

