

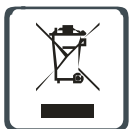

INSTRUCTION MANUAL

Facil HL 1 Black
92433

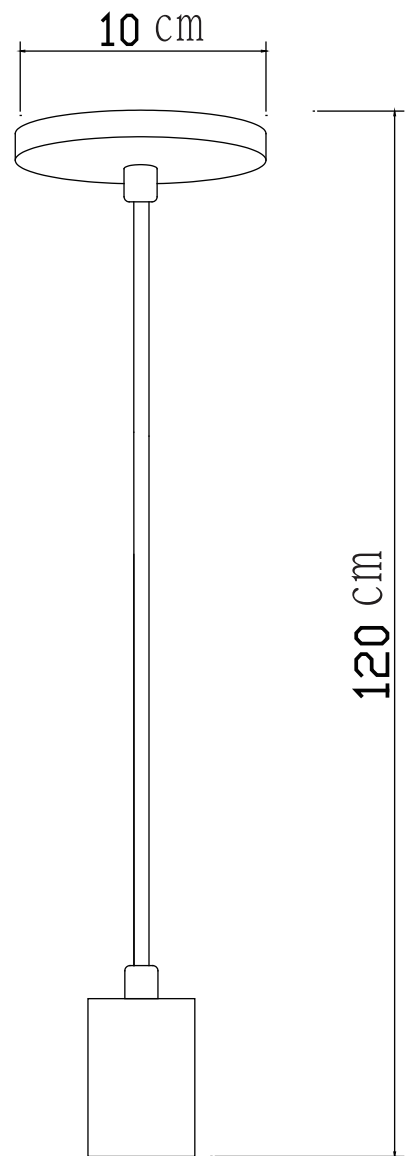
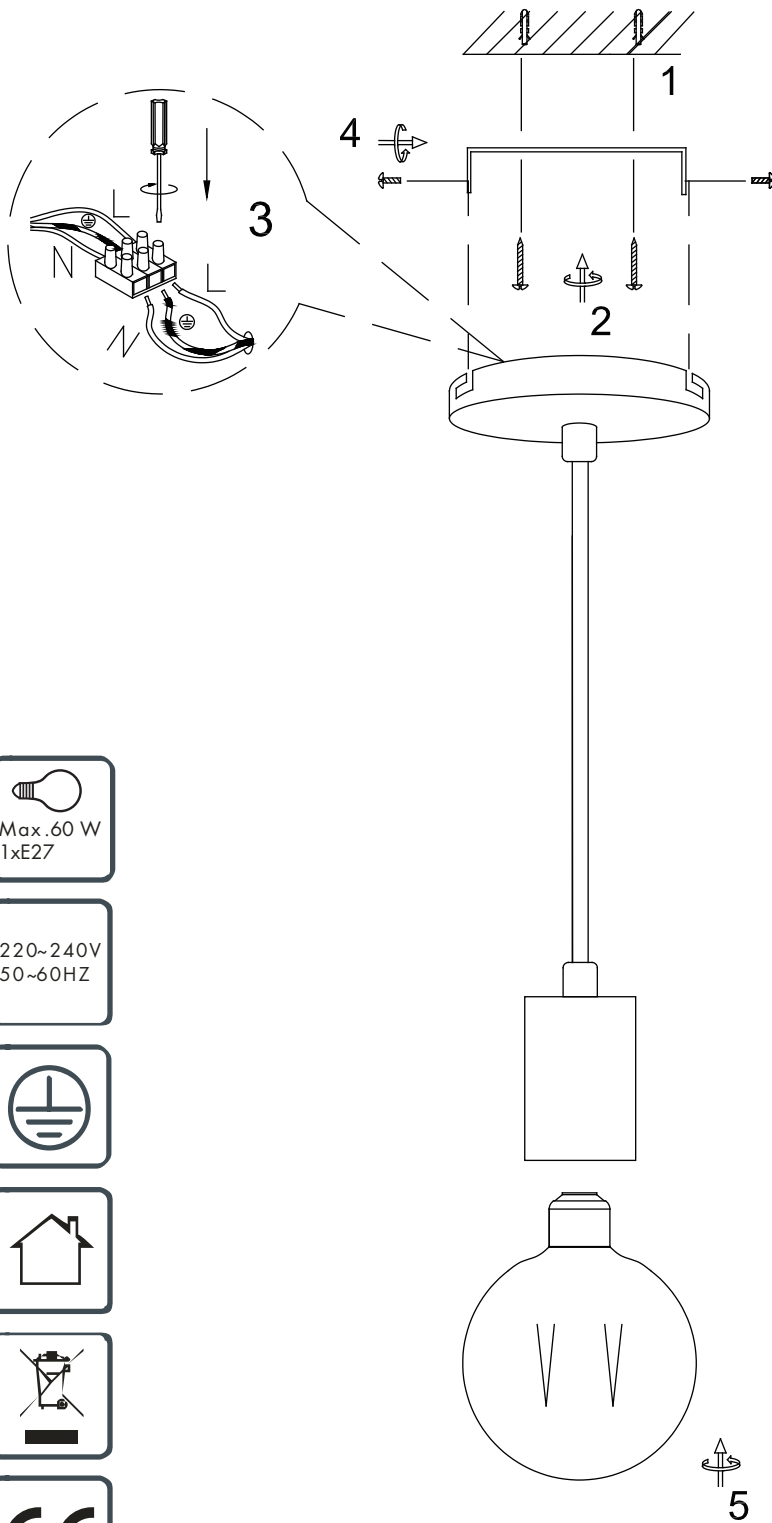

SAFETY DIRECTIONS

Please study the instruction manual and below information carefully before installing or using this product. Please keep this user manual for further reference

1. The luminaires may only be installed by authorized and qualified technicians according the valid regulations for electrical installation.
2. Maintenance of the luminaires is limited to their surfaces. During maintenance no moisture can come into contact with any areas of the terminal connections or voltage control parts.
3. The electrical supply must be switched off at the outset, preferably by means of a switch in the distribution box, before any installation, maintenance or repair work is undertaken.
4. Exterior lighting must not be installed during rain.
6. Take account of the minimal separation distance from other objects and the room required around the fitting.
7. If in any doubt, consult a professional, taking local installation requirements into account. Some countries stipulate that lighting may be installed only by registered installers.
8. Clamping screws in electrical connections must be adequately tightened. This is particularly the case with 12V low voltage conductors.
9. When replacing a halogen lamp, wait for it to cool, for a minimum of 5 minutes.
10. Clean with a clean, dry cloth or brush, use no solvents or abrasives. Avoid dampness on all electrical components
11. Take account of all available technical information.
12. Take note of the symbols when connecting wires:
N =Neutral
L =Live
 =Earth
13. Meaning of symbols:



For indoor use only, where direct contact with water is impossible



Protection class 1: the fitting must be earthed



Protection class 2: the fitting is double insulated and does not require earthing



Protection class 3: the fitting is low voltage



Observe the indicated minimum distance between the lam and the illuminated materials/objects



Only the self-screening halogen illuminants should be used with the luminaire



Strip the wire to the indicated length



Connect using the specified cable



The armature can be used in combination with a dimmer. Consult the sales outlet for the correct type of dimmer(important in the case of 12V fittings)



Suitable for installing on normal inflammable materials



The maximum wattage indicated in each lighting unit, for example, must not be exceed



This luminaire cannot be disposed together with normal domestic waste in standard rubbish bin, but you have to bring it to a staging area for electrical waste



This luminaire was designed to work only with the indicated voltage

CALEX

H O L L A N D

SMART

LED BULB

WiFi 2,4 GHz



2.412-2.472 MHz



1.5dBi



≤18dBm

| | | |
|----|-----------------|----|
| EN | Getting started | 2 |
| NL | Aan de slag | 3 |
| FR | Démarrage | 4 |
| DE | Erste Schritte | 5 |
| PL | Wprowadzenie | 6 |
| CZ | Začínáme | 7 |
| SK | Začínáme | 8 |
| ES | Empezando | 9 |
| IT | Iniziare | 10 |
| DK | Kom i gang | 11 |
| NO | Starter | 12 |
| SV | Komma igång | 13 |
| FI | Päästä alkuun | 14 |

EN Getting started

Set up in 4 easy steps

Before you start write down your network name & password.

Note: this item only works on a 2,4GHz Wifi network, not on a 5GHz WiFi network. Please consult the manual of your router for settings.

1. Download the Calex Smart app from the Google Play store, the Apple Store or scan the QR code.



2. Open the app. First time user? Follow on-screen instructions to create your account. To add this device start by touching 'add device' (+) and follow the on-screen instructions.

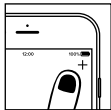

3. Turn the device on. The lamp will start flashing. *(If the lamp or device does not start flashing, switch it on and off 3 times. This will reset the lamp or device.)*
4. Follow the on screen prompts to finish installation.

If you get the notification the product only works on 2,4GHz networks you should change the WiFi-frequency of your network to 2,4GHz only in the setting menu of the router.

NL Aan de slag

Instellen in 4 eenvoudige stappen

Schrijf voordat u begint uw netwerknaam en wachtwoord op..

Opmerking: dit item werkt alleen op een 2,4 GHz wifi-netwerk, niet op een 5 GHz WiFi-netwerk. Raadpleeg de handleiding van uw router voor instellingen.

1. Download de Calex Smart app van de Google Play Store, de Apple Store of scan de QR-code.



2. Open de app. Gebruikt u de app voor de eerste keer. Volg de instructies op het scherm om uw account aan te maken. Om dit apparaat toe te voegen, begint u door 'apparaat toevoegen' (+) aan te raken en volgt u de instructies op het scherm.

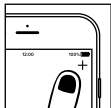

3. Schakel de verlichting in. De lamp begint te knipperen. (Als de lamp of het apparaat niet begint te knipperen, schakelt u het driemaal in en uit. Hiermee wordt de lamp of het apparaat gereset.)
4. Volg de aanwijzingen op het scherm om de installatie te voltooien.

Als u de melding krijgt dat het product alleen op 2,4GHz-netwerken werkt, moet u de wifi-frequentie van uw netwerk naar 2,4 GHz wijzigen alleen in het instellingenmenu van de router.

FR Démarrage

Installation en 4 étapes faciles

Avant de commencer l'installation, vous aurez besoin de noter le nom de votre réseau Wifi et son mot de passe, pensez à bien respecter les espaces et majuscules.

Remarque: le dispositif Smart que vous venez d'acquérir ne fonctionne que sur un réseau Wifi à 2.4GHz, pas sur un réseau WiFi à 5GHz. Veuillez consulter le manuel de votre routeur pour les réglages.

1. Téléchargez l'application Calex Smart sur notre Google Play Store, Apple Store ou scannez le QR code ci-dessous.



2. Ouvrez l'application. Si vous êtes un nouvel utilisateur, suivez les instructions à l'écran pour votre compte. Pour enregistrer votre nouvel appareil, appuyez sur le bouton "Ajouter un appareil" en haut à droite et suivez les instructions à l'écran.

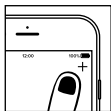

3. Allumer l'appareil. L'ampoule commencera alors à clignoter, cela signifie qu'elle est prête pour l'installation. (Si l'ampoule ne clignote pas, vous pouvez la réinitialiser en l'allumant et en l'éteignant 3 fois. Rallumez-la ensuite et elle se mettra à clignoter.)
4. Suivez les instructions à l'écran pour terminer l'installation.

Si vous recevez la notification que le produit ne fonctionne que sur les réseaux 2,4GHz, vous devez modifier la fréquence WiFi de votre réseau en 2,4GHz. Ceci peut s'effectuer dans le menu de configuration de votre routeur Wifi.

DE Erste Schritte

In 4 einfachen Schritten konfigurieren

Notieren Sie sich den Netzwerknamen und das Kennwort, bevor Sie beginnen.

Hinweis: Dieses Element funktioniert nur in einem 2,4-GHz-WLAN-Netzwerk, nicht in einem 5-GHz-WLAN-Netzwerk. Informationen zu den Einstellungen finden Sie im Handbuch Ihres Routers.

1. Laden Sie die Calex Smart von dem Google Play Store, dem Apple Store herunter oder scannen Sie den QR-Code.



IOS



ANDROID



2. App öffnen Erstbenutzer? Folgen Sie den Anweisungen auf dem Bildschirm, um Ihr Konto zu erstellen. Um dieses Gerät hinzuzufügen, berühren Sie "Gerät hinzufügen" (+) und befolgen Sie die Anweisungen auf dem Bildschirm.

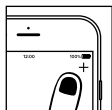

3. Schalten Sie das Gerät ein. Die Lampe beginnt zu blinken. (Wenn die Lampe oder das Gerät nicht zu blinken beginnt, schalten Sie sie dreimal ein und aus. Dadurch werden die Lampe oder das Gerät zurückgesetzt.)
4. Folgen Sie den Anweisungen auf dem Bildschirm, um die Installation abzuschließen.

Wenn Sie eine Benachrichtigung erhalten, funktioniert das Produkt nur in 2,4-GHz-Netzwerken. Sie sollten die WLAN-Frequenz Ihres Netzwerks auf 2,4 GHz ändern nur im Einstellungsmenü des Routers.

PL Wprowadzenie

Skonfiguruj w 4 prostych krokach

Zanim zaczniesz, zapisz nazwę sieci i hasło.

*Uwaga: ten element działa tylko w sieci Wi-Fi 2,4 GHz, a nie w sieci WiFi 5 GHz.
Sprawdź ustawienia routera w instrukcji obsługi.*

1. Pobierz aplikację Calex Smart z naszej strony sklepu Google Play, sklepu Apple Store lub zeskanuj kod QR..



IOS



ANDROID



2. Otwórz aplikację. Pierwszy raz użytkownik? Postępuj zgodnie z instrukcjami wyświetlanymi na ekranie, aby utworzyć konto. Aby dodać to urządzenie, zacznij od dotknięcia „dodaj urządzenie” (+) i postępuj zgodnie z instrukcjami wyświetlanymi na ekranie.

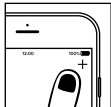

3. Włącz żarówkę. Żarówka zacznie migać. (Jeśli żarówka lub urządzenie nie zacznie migać, włącz je i wyłącz 3 razy. Spowoduje to zresetowanie żarówki lub urządzenia.)
4. Postępuj zgodnie z instrukcjami wyświetlanymi na ekranie, aby zakończyć instalację.

Jeśli otrzymasz powiadomienie, produkt działa tylko w sieci 2,4 GHz, powinieneś zmienić częstotliwość Wi-Fi swojej sieci na 2,4 GHz tylko w menu ustawień routera.

CZ Začínáme

Nastavte ve 4 jednoduchých krocích

Než začnete psát název sítě a heslo.

Poznámka: tato položka funguje pouze v síti WiFi 2,4 GHz, nikoli v síti WiFi 5GHz. Nastavení naleznete v příručce směrovače.

1. Stáhněte si aplikaci Calex Smart z našich, obchodu Google Play, Apple Store nebo naskenujte QR kód.



2. Otevřete aplikaci. Uživatel poprvé? Vytvořte si účet podle pokynů na obrazovce. Chcete-li toto zařízení přidat, stiskněte tlačítko „Přidat zařízení“ (+) a postupujte podle pokynů na obrazovce.

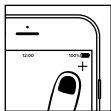

3. Zapněte přístroj. Kontrolka začne blikat. (Pokud kontrolka nebo zařízení nezačne blikat, zapněte a vypněte třikrát. Tím se lampa nebo zařízení resetuje.)
4. Dokončete instalaci podle pokynů na obrazovce.

Pokud obdržíte oznámení, produkt funguje pouze v sítích 2,4 GHz, měli byste změnit frekvenci WiFi vaší sítě na 2,4 GHz pouze v menu nastavení routeru.

SK Začínáme

Nastavenie v 4 jednoduchých krokoch

Skôr ako začnete, zapíšte si názov siete a heslo.

Poznámka: táto položka funguje iba v sieti 2,4GHz WiFi, nie v 5GHz WiFi sieti. Nastavenia nájdete v príručke k smerovaču.

1. Stiahnite si aplikáciu Calex Smart z našej obchodu Google Play, Apple Store alebo naskenujte QR kód.



2. Otvorte aplikáciu. Prvý používateľ? Vytvorte si účet podľa pokynov na obrazovke. Ak chcete pridať toto zariadenie, začnite dotykom na položku „Pridať zariadenie“ (+) a postupujte podľa pokynov na obrazovke.

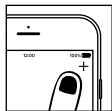

3. Zapnite zariadenie. Kontrolka začne blikať. (Ak kontrolka alebo zariadenie nezačne blikať, zapnite ho a vypnite 3 krát. Tým sa lampka alebo zariadenie vynuluje.)
4. Dokončíte inštaláciu podľa pokynov na obrazovke.

Ak sa vám zobrazí upozornenie, produkt funguje iba v sieťach 2,4 GHz, mali by ste zmeniť frekvenciu WiFi siete na 2,4 GHz iba v menu nastavenia smerovača.

ES Empezando

Configuración en 4 sencillos pasos.

Antes de comenzar, escriba su nombre de red y contraseña.

Nota: este elemento solo funciona en una red Wifi de 2,4 GHz, no en una red WiFi de 5 GHz. Por favor, consulte el manual de su enrutador para la configuración.

1. Descargue la aplicación Calex Smart de nuestro, Google Play Store, Apple Store o escanee el código QR.



2. Abra la aplicación. ¿Usuario primerizo? Siga las instrucciones en pantalla para crear su cuenta. Para agregar este dispositivo, toque “agregar dispositivo” (+) y siga las instrucciones en pantalla.

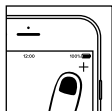

3. Enciende el dispositivo. La lámpara comenzará a parpadear. *(Si la lámpara o el dispositivo no comienzan a parpadear, enciéndalo y apáguelo 3 veces. Esto restablecerá la lámpara o el dispositivo).*
4. Siga las indicaciones en pantalla para finalizar la instalación.

Si recibe la notificación de que el producto solo funciona en redes de 2,4 GHz, debe cambiar la frecuencia WiFi de su red a 2,4 GHz Solo en el menú de configuración del router.

IT Iniziare

Impostare in 4 semplici passaggi

Prima di iniziare scrivi il nome e la password della tua rete.

Nota: questa voce funziona solo su una rete Wi-Fi a 2,4 GHz, non su una rete WiFi a 5 GHz. Si prega di consultare il manuale del router per le impostazioni.

1. Scarica l'app Calex Smart dal nostro, dal Google Play Store, dall'Apple Store o scansiona il codice QR.



2. Apri l'app. Primo utente? Segui le istruzioni sullo schermo per creare il tuo account. Per aggiungere questo dispositivo inizia toccando "aggiungi dispositivo" (+) e segui le istruzioni sullo schermo.

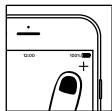

3. Accendi il dispositivo. La lampada inizierà a lampeggiare. (Se la lampada o il dispositivo non inizia a lampeggiare, accendetelo e spegnetelo 3 volte per ripristinare la lampada o il dispositivo.)
4. Seguire le istruzioni visualizzate per completare l'installazione.

Se ricevi la notifica, il prodotto funziona solo su reti a 2,4 GHz, dovresti cambiare la frequenza WiFi della tua rete a 2,4 GHz solo nel menu delle impostazioni del router.

DK Kom i gang

Opstilles i 4 nemme trin

Inden du starter, skal du skrive dit netværksnavn og kodeord.

Bemærk: Denne genstand virker kun på et 2,4 GHz WiFi-netværk, ikke på et 5 GHz WiFi-netværk. Se venligst vejledningen til din router for indstillinger.

1. Download Calex Smart - appen fra vores, Google Play-butikken, Apple Store eller scan QR-koden.



IOS



ANDROID



2. Åbn appen. Første gang bruger? Følg instruktionerne på skærmen for at oprette din konto. For at tilføje denne enhed skal du starte ved at trykke på 'Tilføj enhed' (+) og følg instruktionerne på skærmen.

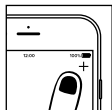

3. Tænd enheden. Lampen begynder at blinke. (Hvis lampen eller enheden ikke begynder at blinke, kal du tænde og slukke 3 gange. Dette vil nulstille lampen eller enheden.)
4. Følg vejledningen på skærmen for at afslutte installationen.

Hvis du får beskeden, fungerer produktet kun på 2,4 GHz-netværk, og du skal ændre WiFi-frekvensen af dit netværk til 2,4 GHz kun i routerens indstillingsmenu.

NO Starter

Sett opp i 4 enkle trinn

Før du begynner å skrive ned nettkretsnavnet og passordet.

Merk: dette elementet fungerer bare på et 2,4 GHz Wifi-nettverk, ikke på et 5 GHz WiFi-nettverk. Se bruksanvisningen til ruter for innstillinger.

1. Last ned Calex Smart-appen fra Google Play-butikken, Apple Store eller skann QR-koden.



2. Åpne appen. Første gang bruker? Følg instruksjonene på skjermen for å opprette kontoen. For å legge til dette enhet starter med å berøre 'legg til enhet' (+) og følg instruksjonene på skjermen.

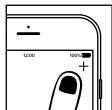

3. Slå på enheten. Lampen begynner å blinke. (Hvis lampen eller enheten ikke begynner å blinke, må du slå den av og på 3 ganger. Dette vil tilbakestille lampen eller enheten.)
4. Følg instruksjonene på skjermen for å fullføre installasjonen.

Hvis du får varselet om at produktet bare fungerer i 2,4 GHz-nettverk, bør du endre WiFi-frekvensen til nettverket ditt til 2,4 GHz bare i innstillingsmenyen til ruter.

SV Komma igång

Stoppa i 4 nemme trin

Inden du starter, skal du skrive dette netværksnavn og kodord.

Bemærk: Denna genstand fungerer endast på 2,4 GHz WiFi-netværk, inte på et 5 GHz WiFi-netværk. Se venligst vejledningen til din router for indstillinger.

1. Ladda ner Calex Smart - appen fra our, Google Play-butikken, Apple Store eller skanna QR-koden.



2. Åbn appen. Første gang användare? Följ instruktionerna på skärmen för på oprette din konto. För på tilføje denna enhed ska du starta vid trycket på 'Lägg till' (+) och segg-instruktionerna på skärmen.

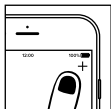

3. Slå på enheten. Lampan börjar blinka. (Om lampan eller enheten inte börjar blinka, slå på och stänga av den tre gånger. Detta återställer lampan eller enheten.)
4. Följ anvisningarna på skärmen för att avsluta installationen.

Om du får besked, arbetar produkt kun på 2,4 GHz-nätverk, och du ska ändra WiFi-frekvensen av dit netværk till 2,4 GHz kun i routerens indstillingsmenu.

FI Päästä alkuun

Opstilles i 4 nemme trin

Alkuperäinen aloitus, mittakaavassa verkostoon ja kodeordiin.

Tekijä: Denne genstand virker kun pv ja 2,4 GHz WiFi-netværk, pp ja et 5 GHz: n WiFi-verkko. Valitse ilmainen reititin reitittimelle.

1. Lataa Calex Smart - liitetiedot, Google Play -aplikken, Apple Store eller scan QR-koden.



2. Åbn-liite. Førsten jengi? Lisää ohjeita tilien lukemiseen tilillesi. Sillä tilføjesså denne enhed skal du starte vedetåæn kokeilemaan pykålåå "Tilføj enhed" (+) ja tåydentåmåæn ohjeita på skåermeniin.

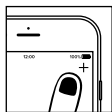

3. Kytke laite påålle. Lamppu alkaa vilkkua. (Jos lamppu tai laite ei ala vilkkua, kytke se påålle ja pois pååltå 3 kertaa. Tåmå nollaa lampun tai laitteen.)
4. Viimeistele asennus noudattamalla nåytån ohjeita.

Hvis du får beskeden, toimintojen tuottaja kun 2,4 GHz-netværk, ja du skal ændre WiFi-tåajuus verkon kautta 2,4 GHz, kun reitittimien valintaikkuna on.

