

SONOFF

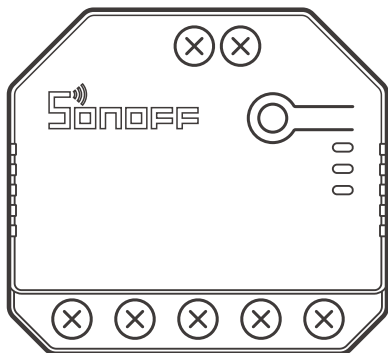

DIY DUALR3

User manual V1.0



2-Gang Wi-Fi Smart Switch

· 中文-----	1-6	· English-----	7-12
· Deutsch-----	13-19	· Español-----	20-26
· Français-----	27-33	· Italiano-----	34-40
· Русский язык-----	41-47	· Português-----	48-54

· FCC Warning-----	55		

使用说明

1. 断电

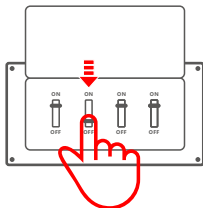

⚠ 设备安装、故障维修请由专业资质电工操作，以免发生触电危险！设备在正常使用的情况下不可触碰到。

2. 接线

电机模式：

① 单键瞬时开关：

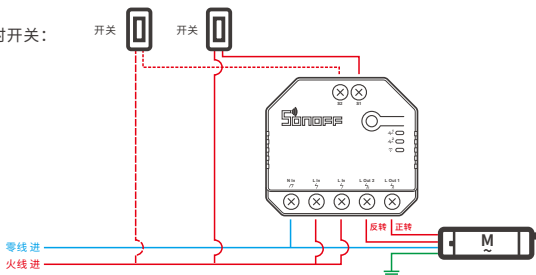

ⓘ S1/S2任意接一路开关即可实现正常开关控制使用，接两路可实现双控。

② 双键瞬时开关、三键翘板开关：

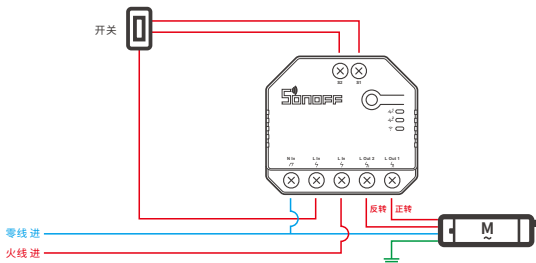

灯具接线示意：

① 脉冲触发模式下接回弹开关、边缘触发模式下接翘板开关实现两路控制：

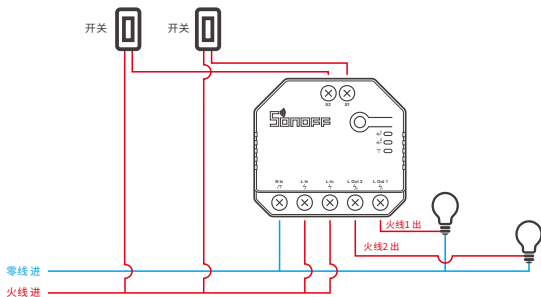

② 边缘触发模式下接单刀双掷开关实现两路双控：

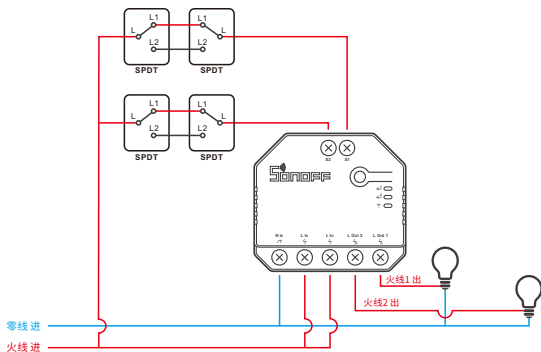

③ 跟随模式下接干接点输出信号传感器：

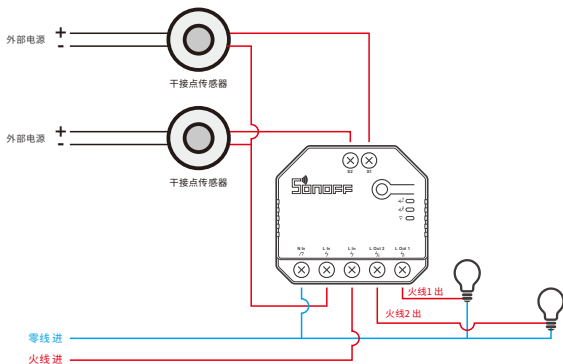

⚠ 确保线路接入无误。

⚠ S1/S2不接机械开关，不影响设备正常使用。

⚠ S1/S2外接机械开关使用时，需通过“易微联”APP选择工作模式方可使用。

3. 下载“易微联”APP



Android™ & iOS

4. 上电

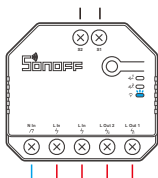

通电后, 设备首次使用, 默认进入蓝牙配网模式。Wi-Fi指示灯呈“两短一长闪烁”。

⚠ 三分钟内没有进行配网, 设备将退出蓝牙配网模式。如需再次进入, 长按配对按钮5秒直到Wi-Fi指示灯呈两短一长闪烁即可。

5. 添加设备



点击“+”, 选择“蓝牙配网”, 再根据app提示进行操作。

产品参数

型号	DUALR3
输入	100-240V AC 50/60Hz 15A Max
输出	100-240V AC 50/60Hz
阻性负载	2200W/10A/通道 3300W/15A/总负载
电机负载	10-240W/1A
Wi-Fi	IEEE 802.11 b/g/n 2.4GHz
支持平台	Android & iOS
通道数量	双通道
工作温度	-10°C~40°C
外壳材料	PC V0
产品规格	54x49x24mm

产品介绍

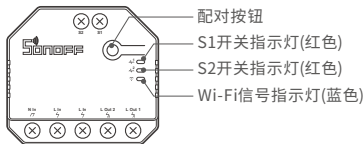

⚠ 设备重量 < 1Kg, 建议安装高度 < 2米。

Wi-Fi信号指示灯状态说明

指示灯状态	状态描述
两短一长闪烁	蓝牙配网模式
常亮	设备已连接
快闪一下	找不到路由
快闪二下	连接上路由, 但没连上服务器
快闪三下	升级中

工作模式

配对成功后, 请根据当前连接设备, 选择对应的工作模式 (开关模式、电机模式或电表模式)。工作模式的详细说明请在“易微联”app端查看。

产品特点

本设备是一款双通道带电量统计的智能开关, 用您的智能手机在任何地方打开或关闭家里的设备, 设置定时开/关、分享给您的家人一起控制等等。



远程控制



智能定时/延时



分享功能



智能场景



同步状态



电量统计



过载保护



点动模式



上电状态设置



局域网功能

更换设备网络

设备更换新的网络环境使用时，需长按设备配对按钮5秒直到Wi-Fi指示灯呈两短一长闪烁，松开，此时设备进入蓝牙配网模式，即可再次添加。

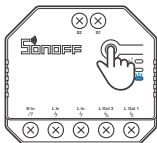

恢复出厂设置

在eWeLink app端“删除设备”，设备即恢复出厂设置。

常见问题

问：设备添加成功后，显示离线，无法控制？

答：设备刚添加成功后，需要1-2分钟时间连接您的路由器并连网。如果长时间还是显示不在线，请根据Wi-Fi指示灯的状态来判断：

1. 蓝灯2秒快闪一下：说明设备没有连上您的Wi-Fi。

- ① 可能是Wi-Fi密码输入不正确。
- ② 可能是设备离您的路由器太远，信号太弱，或环境有干扰。请先将设备靠近路由器，如无改善，重新添加一遍。
- ③ 设备不能识别5G的Wi-Fi，请选择2.4G的Wi-Fi重新添加。
- ④ 检查您的路由器后台是否开启MAC地址过滤，如有，请关闭。

如果以上均尝试不能解决，请用一部手机开启个人热点，尝试重新添加。

2. 蓝灯2秒快闪两下：说明设备已连接到了Wi-Fi但没有连上外网。

请确认您的Wi-Fi当前连接外网是否稳定、正常。如时好时坏，频繁出现这种双闪情况，说明您的网络不稳定，并非产品原因。

Operating Instruction

1. Power off

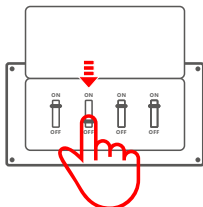

⚠ To avoid electric shocks, please consult the dealer or a qualified professional for help when installing and repairing! Please do not touch the switch during use.

2. Wiring instruction

Motor mode:

① Momentary switch:

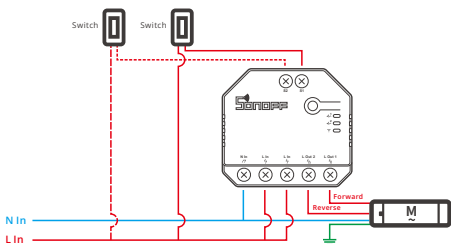

⚠ Connect to S1 or S2 for smart control of connected devices; connect to S1 and S2 for two-way smart control.

② Dual relay momentary switch/3-gang rocker switch:

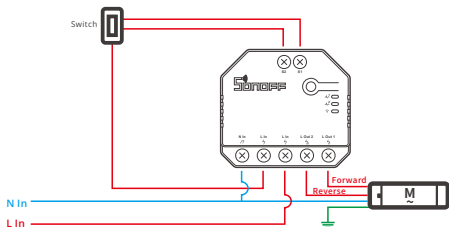

Light fixture wiring instruction:

- ① To enable dual relay control, S1 and S2 are required to connect the push button switch in the pulse mode or the rocker light switch in the edge mode:

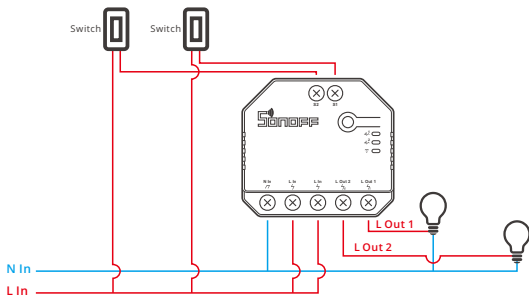

- ② Connect SPDT switches in the edge mode to reach double two-way control:

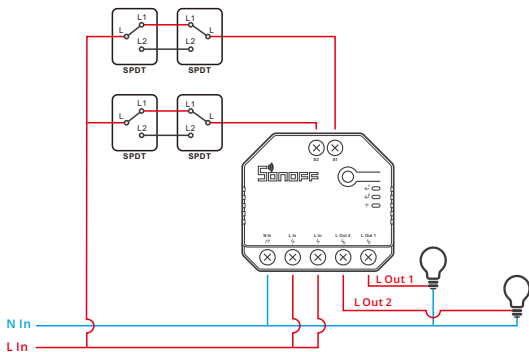

③ Connect dry contact sensors in the following mode:

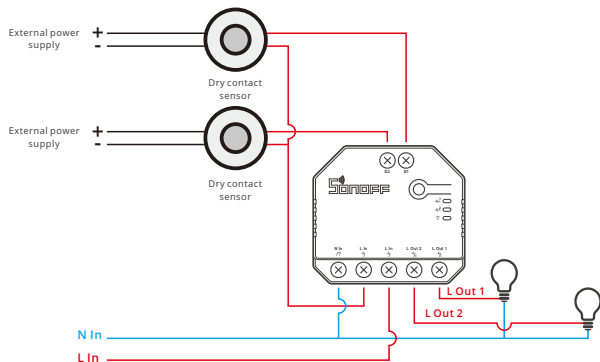

- ⚠ Make sure the neutral wire and live wire connection is correct.
- ⚠ The device still works normally if no a physical light switch is connected to S1/S2.
- ⚠ If S1/S2 is connected to a physical light switch, the corresponding working mode is required in eWeLink APP to select for normal use.

3. Download the eWeLink APP



Android™ & iOS

4. Power on

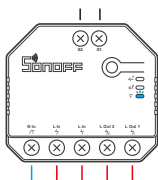

After powering on, the device will enter the bluetooth pairing mode during the first use. The Wi-Fi LED indicator changes in a cycle of two short and one long flash and release.

⚠ The device will exit the bluetooth pairing mode if not paired within 3mins. If you want to enter this mode, please long press the manual button for about 5s until the Wi-Fi LED indicator changes in a cycle of two short and one long flash and release.

5. Add the device



Tap "+" and select "bluetooth pairing", then operate following the prompt on the APP.

Specifications

Model	DUALR3
Input	100-240V AC 50/60Hz 15A Max
Output	100-240V AC 50/60Hz
Resistive Load	2200W/10A/Gang 3300W/15A/Total
Motor Load	10-240W/1A
Wi-Fi	IEEE 802.11 b/g/n 2.4GHz
Operating systems	Android & iOS
Number of gangs	2-Gang
Working temperature	-10°C~40°C
Material	PC V0
Dimension	54x49x24mm

Product Introduction

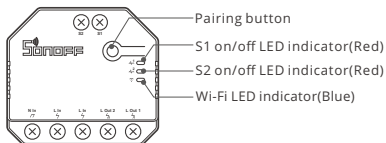

⚠ The device weight is less than 1 kg. The installation height of less than 2 m is recommended.

Wi-Fi LED indicator status instruction

LED indicator status	Status instruction
Flashes (one long and two short)	Bluetooth Pairing Mode
Keeps on	Device is connected successfully
Flashes quickly	Compatible Pairing Mode
Flashes quickly once	Unable to discover the router
Flashes quickly twice	Connect to the router but fail to connect to server
Flashes quickly three times	Upgrading

Working Mode

After pairing, select the corresponding mode from switch, motor and meter modes according to the connected device. Please check the detailed instruction for working modes on eWeLink app.

Features

This device is a Wi-Fi smart switch with power monitoring that allows you to remotely turn on/off the device, schedule it on/off or share it with your family to control together.



Remote Control



Single/Countdown
Timing



Share Control



Smart Scene



Sync Status



Power Monitoring



Over-load
Protection



Inching Mode



Power-on State



LAN Control

Switch Network

If you need to change the network, long press the pairing button for 5s until the Wi-Fi LED indicator changes in a cycle of two short and one long flash and release, then the device enters Bluetooth pairing mode and you can pair again.

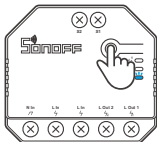

Factory Reset

Deleting the device on the eWeLink app indicates you restore it to factory setting.

Common Problems

Q: Why my device stays "Offline"?

A: The newly added device needs 1 – 2mins to connect Wi-Fi and network. If it stays offline for a long time, please judge these problems by the blue Wi-Fi indicator status:

1. The blue Wi-Fi indicator quickly flashes once per 2 seconds, which means that the switch failed to connect your Wi-Fi:
 - ① Maybe you have entered a wrong Wi-Fi password.
 - ② Maybe there's too much distance between the switch your router or the environment causes interference, consider getting close to the router. If failed, please add it again.
 - ③ The 5G Wi-Fi network is not supported and only supports the 2.4GHz wireless network.
 - ④ Maybe the MAC address filtering is open. Please turn it off.

If none of the above methods solved the problem, you can open the mobile datanetwork on your phone to create a Wi-Fi hotspot, then add the device again.

2. Blue indicator quickly flashes twice per 2 seconds, which means your device has connected to Wi-Fi but failed to connect to the server.

Ensure steady enough network. If double flash occurs frequently, which means you access an unsteady network, not a product problem. If thenetwork is normal, try to turn off the power to restart the switch.

Betriebsanweisung

1. Ausschalten

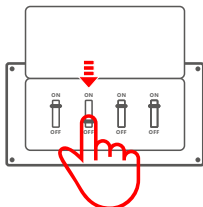

- ⚠ Wenden Sie sich bitte an den Händler oder einen qualifizierten Fachmann, um Hilfe bei der Installation und Reparatur zu erhalten und um Stromschläge zu vermeiden! Bitte berühren Sie den Schalter nicht während des Betriebs nicht.

2. Verkabelungsanleitung

Motor-Modus:

① Moment-tschalter:

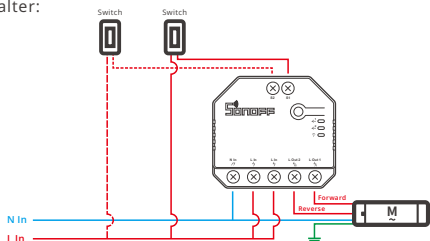

- ⚠ Verbinden Sie sich mit S1 oder S2 für eine intelligente Steuerung der angeschlossenen Geräte; verbinden Sie sich mit S1 und S2 für eine bidirektionale intelligente Steuerung.

② Doppelrelais Moment-schalter/3 Gänge-Wippschalter:

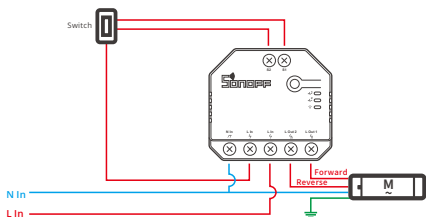

Anleitung zur Verkabelung des Beleuchtungskörpers

- ① Um eine doppelrelais Steuerung zu ermöglichen, sind S1 und S2 erforderlich, um den Drucktastenschalter im Impulsmodus oder den Lichtwippschalter im Flankenmodus anzuschließen:

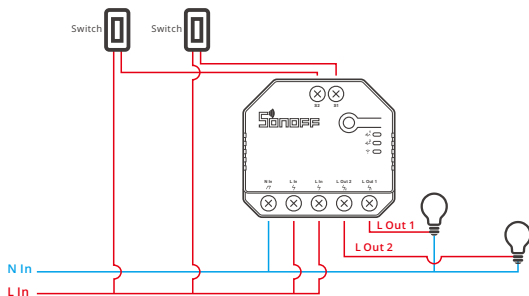

- ② Schließen Sie SPDT-Schalter im Flankenmodus an, erreichen Sie die doppelte Zweiggesteuerung zu erzielen:

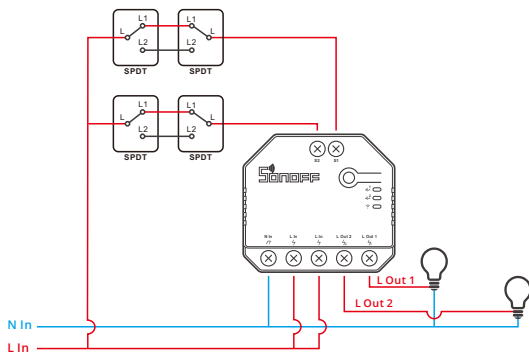

③ Schließen Sie Trockenkontaktsensoren im folgenden Modus an.

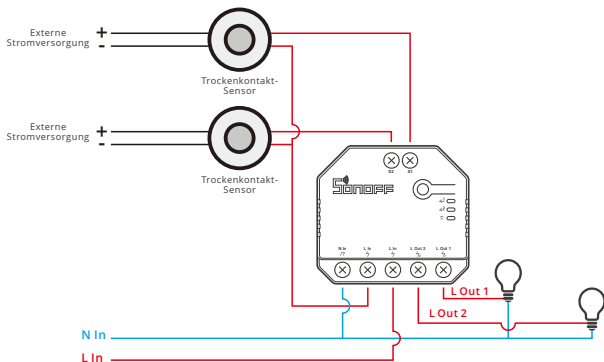

- ⚠ Vergewissern Sie sich, dass der Anschluss von Neutralleiter und stromführender Phase korrekt sind.
- ⚠ Das Gerät funktioniert auch dann noch normal, wenn kein physischer Lichtschalter an S1/S2 angeschlossen ist.
- ⚠ Wenn S1/S2 an einen physischen Lichtschalter angeschlossen ist, muss der entsprechende Arbeitsmodus in eWeLink APP für den normalen Gebrauch ausgewählt werden.

3. APP herunterladen



Android™ & iOS

4. Einschalten

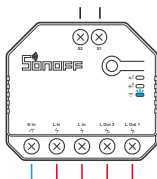

Nach dem Einschalten wechselt das Gerät bei der ersten Inbetriebnahme in den Bluetooth-Paarungsmodus, Die WLAN-LED-Anzeige zu einem Intervall von „zweimaligem kurzen Blinken und einem langen Blinken wechselt“.

- ⓘ Das Gerät beendet den Bluetooth-Paarungsmodus, wenn innerhalb von 3 Minuten keine Kopplung erfolgt. Wenn der Schnellkopplungsmodus erneut aufgerufen werden soll, drücken Sie bitte die Kopplungstaste 5 Sekunden, bis die WLAN-LED-Anzeige zu einem Intervall von zweimaligem kurzen Blinken und einem langen Blinken wechselt und lassen Sie erst dann die Taste los.

5. Gerät hinzufügen



Tippen Sie auf „+“, wählen Sie „ Bluetooth-Paarung “ und arbeiten Sie dann gemäß der Aufforderung auf der APP.

Technische Daten

Modell	DUALR3
Eingang	100-240V AC 50/60Hz 15A Max
Ausgang	100-240V AC 50/60Hz
Max. Last	2200W/10A/Einzelschalter 3300W/15A/Alle Schalter
Motor Last	10-240W/1A
WLAN	IEEE 802.11 b/g/n 2.4GHz
Betriebssysteme	Android & iOS
Anzahl der Gänge	2-Gang
Arbeitstemperatur	-10°C~40°C
Materialien	PC V0
Abmessungen	54x49x24mm

Produktvorstellung

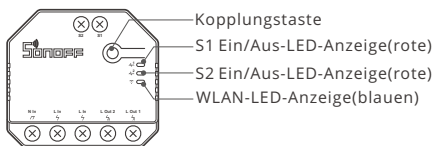

ⓘ Das Gerätegewicht beträgt weniger als 1 kg. Es wird eine Installationshöhe von weniger als 2 m empfohlen.

WLAN LED-Anzeige Statusanzeige Anweisung

Wi-Fi LED-Anzeige Status	Status-Anweisung
Blinkt (einmal lang und zweimal kurz)	Schnellkopplungsmodus
Ist immer an	Gerät ist erfolgreich verbunden
Schnell blinkt	Kompatibler Kopplungsmodus
Blinkt einmal schnell	Der Router konnte nicht gefunden werden
Blinkt zweimal schnell	Erfolgreiche Verbindung zum Router, aber server ist nicht verbunden
Blinkt dreimal schnell	Aktualisierung

Arbeits-Modus

Nach erfolgreicher Paarung wählen Sie den entsprechenden Modus aus Schalter-, Motor- und Zählermodus auf der Grundlage des angeschlossenen Geräts aus. Bitte beachten Sie die detaillierte Anleitung zu den Arbeitsmodi der eWeLink-App.

Merkmale

Dieses Gerät ist ein Wi-Fi-Smart-Switch mit Stromüberwachung, mit dem Sie das Gerät ferngesteuert ein- und ausschalten, einen Zeitplan für das Ein- und Ausschalten festlegen oder das Gerät zusammen mit Ihrer Familie zur gemeinsamen Steuerung nutzen können.



App Fernbedienug



Zeitpläne



Freigabesteuerung



Intelligente Szenarien



Synchronisationsstatus



Leistungsüberwachung



Überlastschutz



Tippbetrieb



Einschaltstatus



LAN-Steuerung

Schalt-Netzwerk

Wenn Sie das Netzwerk wechseln müssen, drücken Sie die Paarungstaste 5s lang, bis die Wi-Fi-LED-Anzeige in einem Zyklus von zwei kurzen und einem langen Aufblitzen und Loslassen wechselt und das Gerät in den Schnellkopplungsmodus wechselt, Sie können dann erneut paaren.

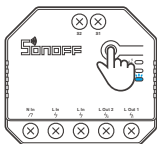

Zurücksetzen auf Werkseinstellungen

Wenn Sie das Gerät in der eWeLink-App löschen, wird es auf die Werkseinstellung zurückgesetzt.

Häufige Probleme

F: Warum bleibt mein Gerät „offline“?

A: Das neu hinzugefügte Gerät benötigt ca. 1 bis 2 Min., um die Verbindung zum WLAN und Netzwerk herzustellen. Wenn es längere Zeit offline bleibt, überprüfen Sie diese Probleme bitte anhand des Status der blauen WLAN-Anzeige:

1. Die blaue WLAN-Anzeige blinkt schnell einmal pro zwei Sekunden, das bedeutet, dass der Schalter keine Verbindung mit dem WLAN herstellen konnte:
 - ① Vielleicht haben Sie ein falsches Passwort eingegeben.
 - ② Vielleicht ist der Abstand zwischen dem Schalter und dem Router zu groß oder es gibt Störungen in der Umgebung. Versuchen Sie, näher an den Router zu gelangen. Falls dies fehlschlägt, fügen Sie das Gerät bitte erneut hinzu.
 - ③ Ein 5G-WLAN-Netzwerk wird nicht unterstützt. Es wird nur ein kabelloses 2,4-GHz-Netzwerk unterstützt.
 - ④ Vielleicht ist die MAC-Adressfilterung geöffnet. Schalten Sie diese bitte aus.**Wenn das Problem durch keine der oben genannten Methoden behoben wurde, können Sie das mobile Datennetz auf Ihrem Handy öffnen, um einen WLAN-Hotspot aufzubauen, und das Gerät dann erneut hinzuzufügen.**

2. Die blaue Anzeige blinkt schnell zweimal pro zwei Sekunden, dies bedeutet, dass Ihr Gerät mit dem WLAN verbunden ist, aber keine Verbindung zum Server hergestellt wurde.

Stellen Sie sicher, dass das Netzwerk stabil genug ist. Wenn häufiger ein zweifaches Blinken auftritt, bedeutet dies, dass nur ein instabiles Netzwerk zur Verfügung steht. Dies stellt keinen Fehler des Produkts dar. Wenn der Netzwerkstatus normal ist, versuchen Sie, die Stromversorgung auszuschalten, um den Schalter neu zu starten.

Instrucciones de funcionamiento

1. Apagado

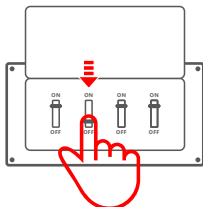

- ⚠ Para evitar descargas eléctricas, consulte con su distribuidor o un profesional cualificado para solicitar ayuda durante la instalación y la reparación! No toque el interruptor durante el uso.

2. Instrucciones de cableado

Modo Motor:

- ① Interruptor de acción momentánea:

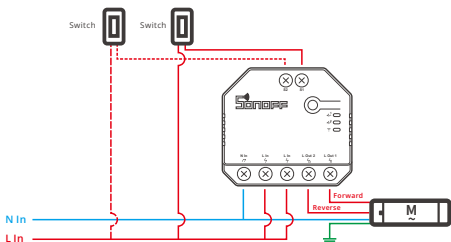

- Ⓜ Conecte a S1 o S2 para un control inteligente de los dispositivos; conecte a S1 y S2 para un control inteligente bidireccional.

- ② Interruptor de doble relé de acción momentánea/Interruptor oscilador de 3 entradas:

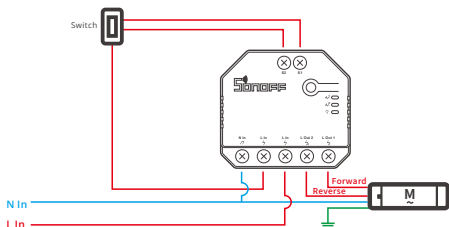

Instrucciones de cableado para aplique de luz:

- ① Para habilitar el control relé doble, conecte S1 y S2 al interruptor pulsador en modo "pulse" o al interruptor basculante (tipo rocker) en modo "edge":

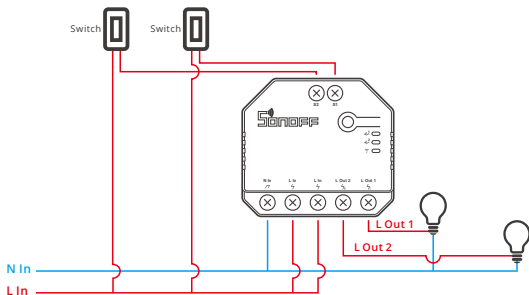

- ② Conecte los interruptores SPDT en modo "edge" para doble control bidireccional:

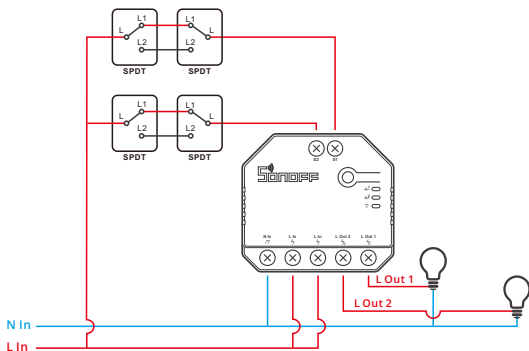

③ Conecte los sensores de contacto seco en el siguiente modo:

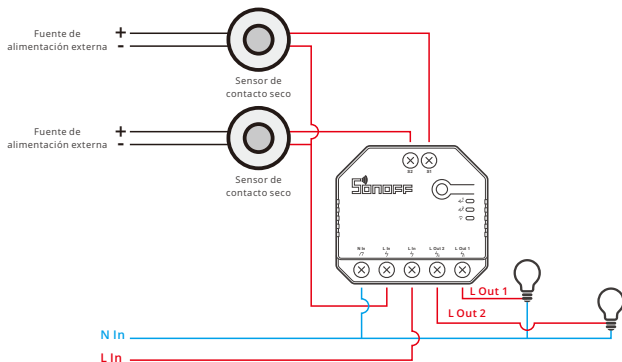

- ⚠ Compruebe que las conexiones del cable neutro y activo sean correctas.
- ⚠ El dispositivo funciona normalmente si no hay un interruptor de luz físico conectado a S1 / S2.
- ⚠ Para el uso normal de un interruptor físico que haya sido conectado a S1/S2, deberá seccionar el modo de trabajo correspondiente en la APP eWeLink.

3. Descargar la aplicación

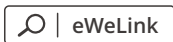

Android™ & iOS

4. Encender

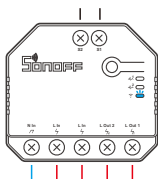

Después de encender, el dispositivo se pondrá en modo de emparejamiento por Bluetooth durante el primer uso. El indicador LED de Wi-Fi cambia a "un ciclo de dos parpadeos cortos y uno largo".

⚠ El dispositivo saldrá del modo de emparejamiento por Bluetooth si no se ha emparejado al cabo de 3 minutos. Si necesita volver a ese modo, mantenga presionado el botón de emparejamiento 5 segundos hasta que el LED indicador de Wi-Fi cambie a un ciclo de dos parpadeos cortos y uno largo. A continuación, suelte el botón.

5. Añadir el dispositivo



Pulse "+" y seleccione "Emparejamiento por Bluetooth", luego opere siguiendo las indicaciones de la aplicación.

Especificaciones

Modelo	DUALR3
Entrada	100-240V AC 50/60Hz 15A máxima
Salida	100-240V AC 50/60Hz
Carga máxima	2200W/10A/Conexión 3300W/15A/Total
Carga motor:	10-240W/1A
Wi-Fi	IEEE 802.11 b/g/n 2.4GHz
Sistemas operativos	Android & iOS
Número de entradas	2
Temperatura de funcionamiento	-10°C~40°C
Materiale	PC V0
Dimensiones	54x49x24mm

Introducción al producto

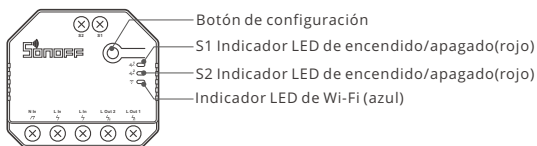

- ⚠ El peso del dispositivo es inferior a 1 kg.
Se recomienda una altura de instalación inferior a 2 m.

Instrucciones del indicador de estado Wi-Fi LED

Wi-Fi Indicador de Estado LED	Instrucción de estado
Parpadea (uno largo y dos cortos)	Modo de emparejamiento rápido
Siempre está encendida	El dispositivo está conectado correctamente
Parpadea rápidamente	Modo de emparejamiento compatible
Parpadea rápidamente una sola vez	Incapaz de encontrar el router
Parpadea rápidamente dos veces	Conectado al router correctamente pero el servidor no está conectado.
Parpadea rápidamente tres veces	Actualización

Modo Trabajo

Luego de emparejar con éxito, elija el modo correspondiente del modo motor, interruptor y medidor basado en el dispositivo conectado. Por favor, revise las instrucciones detalladas para los modos de trabajo en la aplicación eWeLink.

Características

Este dispositivo es un interruptor inteligente Wi-Fi con control de potencia que te permite apagar o prender el dispositivo de manera remota, programar el encendido o apagado o de compartir con tu familia para controlarlo todos juntos.



Control remoto desde aplicación



Programas



Control compartido



Escenas



Estado de sincronización



Monitoreo de Alimentación



Protección de Sobrecarga



Marcha lenta



Indicador de encendido



Control vía

Cambiar Red

Si necesitas cambiar la red, presiona sin soltar el botón de emparejamiento por 5 segundos hasta que el indicador de Wi-Fi LED cambie a un ciclo de dos parpadeos cortos y un parpadeo largo para luego soltar, y luego de que dispositivo entre en el modo de emparejamiento rápido, podrás emparejarlo de nuevo.

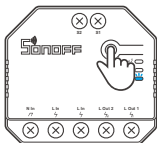

Restablecimiento de los ajustes de fábrica

Si borras el dispositivo en la aplicación eWeLink se restaurará a valores de fábrica.

Problemas frecuentes

P: ¿Por qué el dispositivo permanece “Sin conexión”?

A: El dispositivo recién añadido necesita de 1 a 2 minutos para conectarse a Wi-Fi y a la red. Si permanece sin conexión durante mucho tiempo, evalúe la situación con el estado del indicador azul de Wi-Fi.

1. El indicador azul de Wi-Fi parpadea rápidamente una vez por dos segundos, lo cual significa que el interruptor no se ha podido conectar a la red Wi-Fi:

- ① Es posible que haya introducido una contraseña de Wi-Fi incorrecta.
- ② Es posible que la distancia entre el interruptor y el router sea demasiado grande o que el entorno provoque interferencias. Piense en acercarlos entre sí. Si falla, vuelva a añadirlo.
- ③ La red 5G Wi-Fi no es compatible y solo admite la red inalámbrica de 2,4 GHz.
- ④ Es posible que el filtrado de direcciones MAC esté activado. Desactívelo.

Si no ha sido posible solucionar el problema mediante ninguno de los métodos anteriores, puede abrir la red de datos móviles del teléfono para crear un punto de acceso Wi-Fi y, a continuación, volver a añadir el dispositivo.

2. El indicador azul parpadea rápidamente dos veces por dos segundos, lo cual significa que el dispositivo se ha conectado a Wi-Fi pero no se ha podido conectar al servidor.

Asegúrese de que la red sea estable. Si el doble parpadeo ocurre con frecuencia, esto significa que se accede a una red poco estable, no es un problema del producto. Si la red es normal, intente apague la alimentación para reiniciar el interruptor.

Instruction d'opération

1. Éteindre

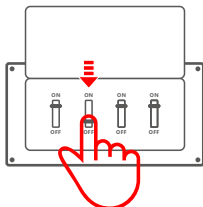

⚠ Pour éviter les électrocutions, prenez contact avec le revendeur ou un professionnel qualifié pour obtenir de l'aide pour l'installation et les réparations éventuelles! Veuillez ne pas toucher l'interrupteur pendant l'utilisation.

2. Instructions de câblage

Mode moteur:

① Interrupteur momentanée:

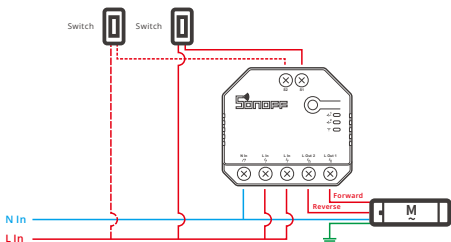

ⓘ Connectez-vous à S1 ou S2 pour un contrôle intelligent des appareils connectés ; connectez-vous à S1 et S2 pour un contrôle intelligent bidirectionnel

② Interrupteur momentanée à double relais/Interrupteur à bascule à 3 bandes:



Schéma de câblage de la lampe de contrôle:

- ① Pour activer le contrôle à double relais, S1 et S2 sont nécessaires pour connecter l'interrupteur à bouton-poussoir en mode impulsion ou l'interrupteur à bascule en mode bordure.



- ② Connectez les interrupteurs SPDT en mode « edge » pour obtenir un double contrôle bidirectionnel:

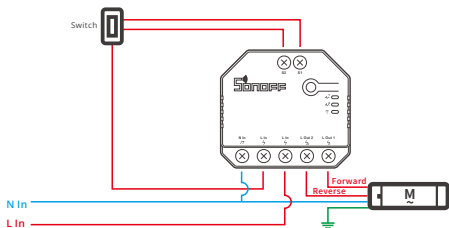
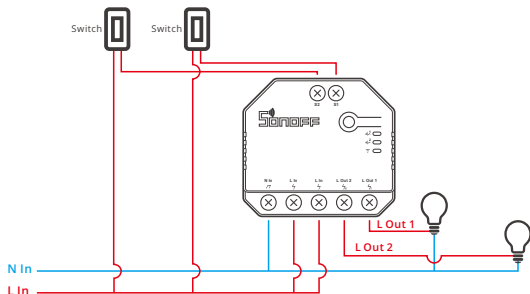
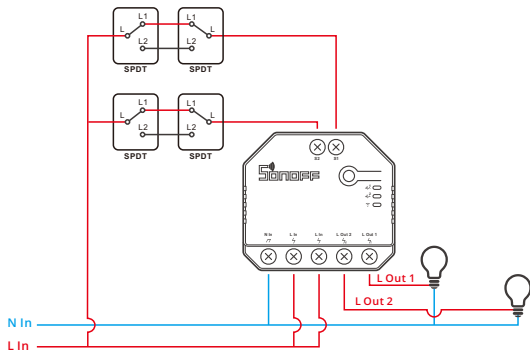

③ Connectez les capteurs à contact sec dans le mode suivant:

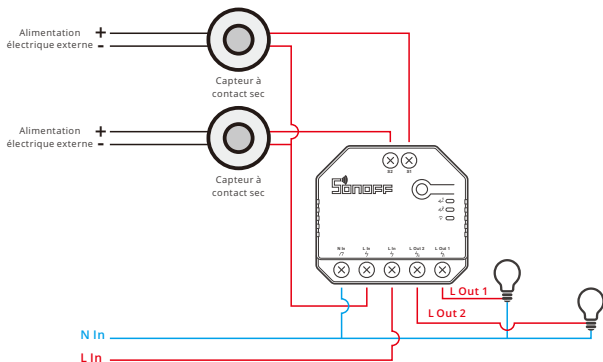

- ⚠ Assurez-vous que le fil neutre et le fil sous tension sont correctement installés.
- ⚠ Le dispositif fonctionne toujours normalement si aucun interrupteur physique n'est connecté à S1/S2.
- ⚠ Si S1/S2 est connecté à un interrupteur physique, le mode de fonctionnement correspondant doit être sélectionné dans eWeLink APP pour une utilisation normale.

3. Télécharger l'application



Android™ & iOS

4. Allumer

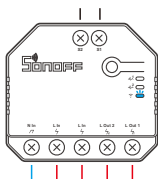

Après allumage, l'appareil entre en mode d'appairage Bluetooth lors de l'utilisation initiale, Que l'indicateur DEL Wi-Fi clignote « deux fois rapidement puis une fois rapidement ».

⚠ L'appareil quitte le mode d'appairage Bluetooth s'il n'est pas jumelé dans les 3 minutes. Pour y revenir, appuyer longuement sur le bouton de configuration 5 secondes jusqu'à ce que l'indicateur à DEL du Wi-Fi effectue un cycle de deux éclats courts et un éclat long puis relâcher.

5. Ajouter l'appareil



Tapez sur « + » et sélectionnez « Appairage Bluetooth », puis suivez l'invite sur l'application.

Caractéristiques techniques

Modèle	DUALR3
Entrée	100-240V AC 50/60Hz 15A Max.
Sortie	100-240V AC 50/60Hz
Chargement Max.	2200W/10A/Gang 3300W/15A/Total
Chargement moteur	10-240W/1A
Wi-Fi	IEEE 802.11 b/g/n 2.4GHz
Systèmes d'exploitation	Android & iOS
Nombre de bandes	2
Température de travail	-10°C~40°C
Matériel	PC V0
Dimensions	54x49x24mm

Présentation du produit

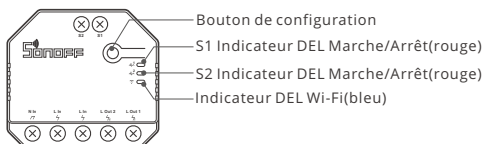

⚠ Le poids du dispositif est inférieur à 1 kg.

Il est recommandé d'installer le dispositif à une hauteur inférieure à 2 m.

Wi-Fi Instruction d'état du voyant

Statut de l'indicateur Wi-Fi LED	Instruction d'état
Clignote (une longue et deux courtes)	Mode de couplage rapide
Est toujours allumé	L'appareil est connecté avec succès
Clignote rapidement	Mode d'appairage compatible
Clignote rapidement une fois	Impossible de trouver le routeur
Clignote rapidement deux fois	Connexion réussie au routeur, mais le serveur n'est pas connecté
Clignote rapidement trois fois	Mise à jour

Mode de fonctionnement

Une fois le couplage réussi, sélectionnez le mode correspondant parmi les modes interrupteur, moteur et compteur en fonction de l'appareil connecté. Veuillez consulter les instructions détaillées des modes de fonctionnement sur l'application eWeLink.

Caractéristiques

Cet appareil est un commutateur intelligent Wi-Fi avec surveillance de la puissance qui vous permet d'allumer/d'éteindre l'appareil à distance, de le programmer ou de le partager avec votre famille pour le contrôler ensemble.



Appli
télécommande



Planification



Contrôle partagé



Scènes
intelligentes



État de
synchronisation



Surveillance
de la puissance



Protection contre
les surcharges



Avance lente



État de mise sous
tension



Contrôle via
LAN

Réseau de commutation

Si vous devez changer de réseau, appuyez longtemps sur le bouton d'appairage pendant 5s jusqu'à ce que le voyant lumineux Wi-Fi change en un cycle de deux clignotements courts et un clignotement long, puis relâchez et l'appareil passe en mode de couplage rapide, puis vous pouvez à nouveau vous appairer.

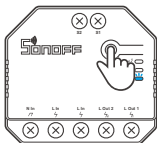

Rétablissement des paramètres d'usine

La suppression de l'appareil sur l'application eWeLink indique que vous le restaurez aux réglages d'usine.

Problèmes courants

Q : Pourquoi mon appareil reste-t-il « Hors ligne » ?

A: Un appareil que vous venez d'ajouter requiert 1 à 2 minutes pour se connecter au Wi-Fi et au réseau. S'il reste hors ligne pendant une durée prolongée, voyez les informations données par l'indicateur Wi-Fi :

1. L'indicateur Wi-Fi bleu clignote brièvement une fois par deux secondes. Cela indique que l'interrupteur ne réussit pas à se connecter à votre Wi-Fi.
 - ① Il se peut que vous ayez saisi un mot de passe Wi-Fi incorrect.
 - ② Peut-être que votre interrupteur est trop éloigné de votre router ou que votre environnement contient des interférences. Rapprochez l'interrupteur du router si possible. En cas d'échec, ajoutez-le de nouveau.
 - ③ La fréquence Wi-Fi 5G n'est pas prise en charge. Seule la fréquence 2.4 GHz peut être utilisée.
 - ④ Le filtrage d'adresse MAC est peut-être activé. Désactivez le filtrage MAC.

Si aucune des méthodes ci-dessus n'a résolu le problème, vous pouvez ouvrir le réseau de données mobile sur votre téléphone pour créer un point d'accès sans fil Wi-Fi, puis ensuite ajouter à nouveau l'appareil.

2. L'indicateur bleu clignote rapidement deux fois par deux secondes, ce qui indique que l'interrupteur est connecté au Wi-Fi mais n'arrive pas à se connecter au serveur. Vérifiez que le réseau fonctionne correctement. Si l'indicateur clignote deux fois rapidement, cela indique que votre réseau est instable, pas que le dispositif est en panne. Si votre réseau est normal, essayez d'éteindre l'appareil et le redémarrer.

Istruzioni per l'uso

1. Spegnimento

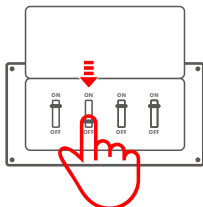

- ⚠ Per evitare scosse elettriche, consultare il rivenditore o un professionista qualificato per assistenza durante l'installazione e la riparazione!
Non toccare l'interruttore durante l'uso.

2. Istruzioni per il cablaggio

Modalità motore:

- ① Interruttore momentaneo:

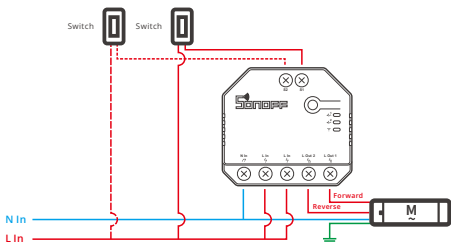

- ⓘ Collegare a S1 o S2 per il controllo intelligente dei dispositivi collegati; collegare a S1 e S2 per il controllo intelligente bidirezionale.

- ② Interruttore momentaneo a doppio relè/Interruttore a bilanciere a 3 canali:

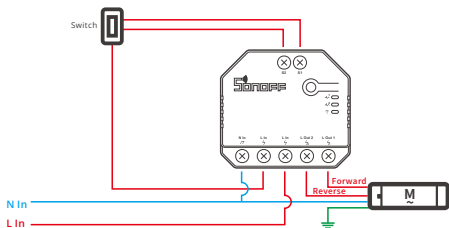

Istruzioni per il collegamento della lampada:

- ① Per abilitare il controllo a doppio relè, S1 e S2 devono essere collegati all'interruttore a pulsante nella modalità a impulsi o all'interruttore a bilanciere nella modalità edge:

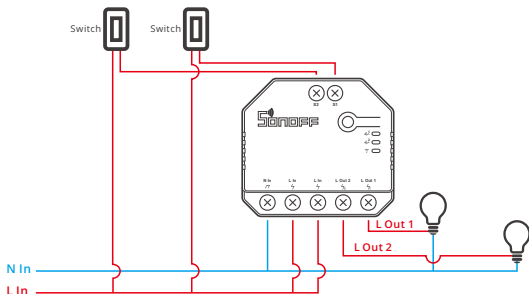

- ② Collegare gli interruttori SPDT nella modalità edge per ottenere il doppio controllo a due vie:

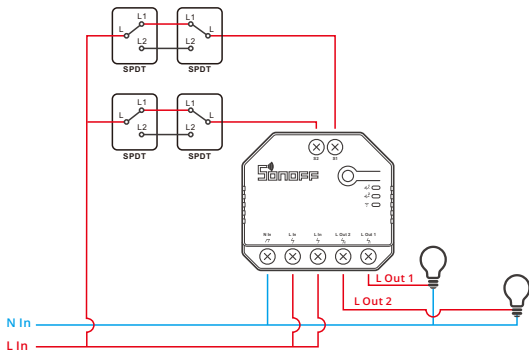

③ Collegare i sensori di contatto a secco nella seguente modalità:

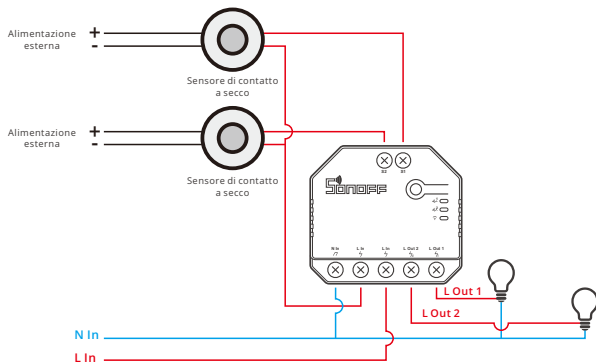

- ⚠ Assicurarsi che il collegamento del cavo di neutro e del cavo di fase sia corretto.
- ⚠ Il dispositivo lavora normalmente anche se S1/S2 non sono collegati a un interruttore fisico della luce.
- ⚠ Se S1/S2 sono collegati a un interruttore fisico della luce, è necessario selezionare la corrispondente modalità di lavoro standard nell'APP eWeLink.

3. Scarica la APP

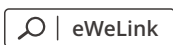

Android™ & iOS

4. Accensione

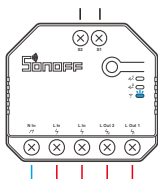

Dopo l'accensione, il dispositivo entrerà nella modalità di associazione Bluetooth durante il primo utilizzo, l'indicatore LED del Wi-Fi passa a "un ciclo di due lampeggi brevi e uno lungo".

- ⚠ Il dispositivo uscirà dalla modalità di associazione Bluetooth se non abbinato entro 3 minuti. Se avete necessità di effettuare nuovamente l'accesso, premere a lungo il pulsante di accoppiamento 5 sec fino a quando la spia LED del Wi-Fi lampeggia ciclicamente due volte velocemente ed una volta a lungo, quindi rilasciare.

5. Aggiungere il dispositivo



Toccare "+" e selezionare "Associazione Bluetooth", quindi procedere seguendo le indicazioni dell'APP.

Specifiche

Modello	DUALR3
Ingresso	100-240V AC 50/60Hz 15A massima.
Uscita	100-240V AC 50/60Hz
Potenza massima.	2200W/10A/Canale 3300W/15A/Totale
Potenza motore	10-240W/1A
Standard Wi-Fi	IEEE 802.11 b/g/n 2.4GHz
Sistemi operativi	Android & iOS
Numero di canali	2
Temperatura di funzionamento	-10°C~40°C
Materiali	PC V0
Dimensioni	54x49x24mm

Introduzione al prodotto

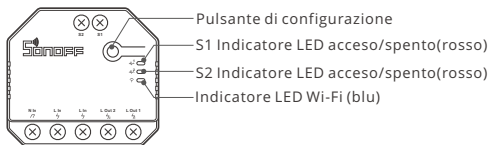

ⓘ Il peso del dispositivo è inferiore a 1 kg.

Si raccomanda un'altezza di installazione inferiore a 2 m.

Istruzioni sullo stato dell'indicatore Wi-Fi LED

Stato dell'indicatore Wi-Fi LED	Istruzioni sullo stato
Il LED blu un ciclo di due lampeggi brevi e uno lungo	Modalità di accoppiamento rapido
Il LED blu costantemente accesa	Il collegamento del dispositivo è stato eseguito correttamente
Il LED blu che lampeggia rapidamente	Modalità di accoppiamento compatibile
Il LED blu che lampeggia rapidamente una volta sola	Impossibile trovare il router
Il LED blu che lampeggia rapidamente per due volte	Il collegamento con il router è stato eseguito correttamente ma al server non è connesso.
Il LED blu che lampeggia rapidamente per tre volte	Aggiornamento

Modalità di funzionamento

Dopo aver eseguito con successo l'associazione, selezionare la modalità corrispondente tra la modalità interruttore, motore e contatore in base al dispositivo collegato. Si prega di controllare le istruzioni dettagliate per le modalità di funzionamento sull'applicazione eWeLink.

Caratteristiche

Questo dispositivo è un interruttore intelligente Wi-Fi con monitoraggio dell'alimentazione che consente di accendere/spegnere il dispositivo da remoto, programmarlo o condividerlo con la famiglia per controllarlo insieme.



Telecomando
via APP



Programmazione



Controllo della
condivisione



Scene intelligenti



Stato della
sincronizzazione



Monitoraggio
della potenza



Protezione
da sovraccarico



A impulsi



Stato di accensione



Controllo LAN

Rete di commutazione

Se è necessario commutare la rete, premere a lungo il pulsante di accoppiamento per 5s fino a quando l'indicatore LED Wi-Fi inizia a lampeggiare ciclicamente con 2 brevi accensioni e una più lunga e quindi si spegne. Il dispositivo entra in modalità di accoppiamento rapido; a questo punto è possibile eseguire di nuovo l'associazione.

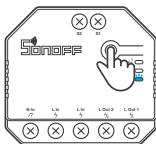

Ripristino impostazioni di fabbrica

La cancellazione del dispositivo sull'applicazione eWeLink indica il ripristino delle impostazioni di fabbrica.

Problemi comuni

D: Perché il mio dispositivo rimane "Offline"?

R: Il dispositivo appena aggiunto ha bisogno di 1 - 2 minuti per connettersi al Wi-Fi e alla rete. Se rimane offline per un lungo periodo, individuare il problema in base allo stato dell'indicatore Wi-Fi blu:

1. L'indicatore blu Wi-Fi lampeggia velocemente una volta al due secondi, il che significa che l'interruttore non è riuscito a connettersi al Wi-Fi:
 - ① Forse è stata inserita una password del Wi-Fi sbagliata.
 - ② Forse c'è troppa distanza tra l'interruttore e il proprio router o l'ambiente causa interferenze, provare ad avvicinare il router. Se non funziona, effettuare nuovamente l'operazione di accoppiamento.
 - ③ La rete Wi-Fi 5G non è supportata, mentre è supportata solo la rete wireless a 2,4 GHz.
 - ④ Forse il filtro degli indirizzi MAC è aperto. Nel caso, disattivarlo.

Se nessuno dei suggerimenti di cui sopra ha risolto il problema, è possibile aprire la rete dati mobile sul telefono per creare un hotspot Wi-Fi, quindi aggiungere nuovamente il dispositivo.

2. L'indicatore blu lampeggia velocemente due volte al due secondi, il che significa che il dispositivo è connesso al Wi-Fi ma non è riuscito a connettersi al server. Verificare che la rete sia sufficientemente stabile. Se il doppio lampeggio si verifica frequentemente, significa che si cerca di accedere a una rete instabile e non si tratta di un problema del prodotto. Se la rete è normale, provare a spegnere il dispositivo per riavviare l'interruttore.

Инструкция по эксплуатации

1. Выключить

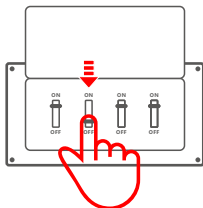

⚠ Во избежание поражения электрическим током при установке и ремонте обращайтесь за консультациями к продавцу или квалифицированному специалисту! Не касайтесь переключателя во время использования.

2. Инструкции по проводке

Режим двигателя:

① быстродействующий выключатель:

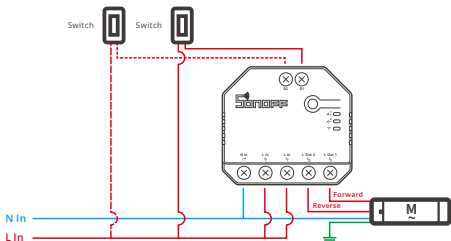

⚠ Подключитесь к S1 или S2 для умного управления подключенными устройствами; подключитесь к S1 и S2 для двустороннего умного управления.

② Двойное реле быстродействующий выключатель/3-блоков клавишный выключатель:

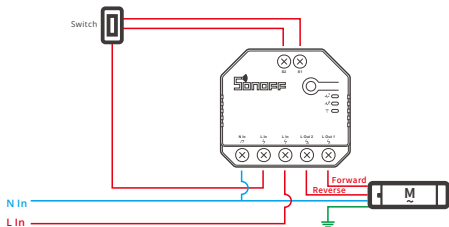

Инструкция по подключению светильника:

- ① Для того чтобы включить двойное реле управления, для S1 и S2 необходимо подключить кнопочный выключатель в импульсном режиме или кулисный выключатель в краевом режиме:

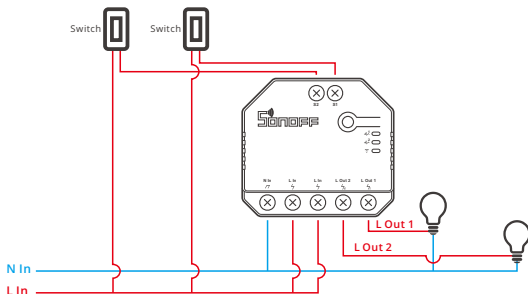

- ② Подключите выключатели SPDT в краевом режиме для достижения двойное двустороннее управление :

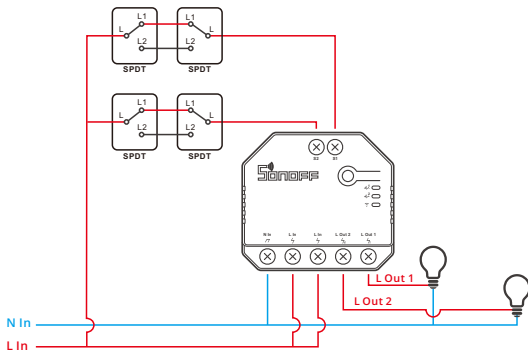

③ Подключите датчики с сухим контактом в следующем режиме:

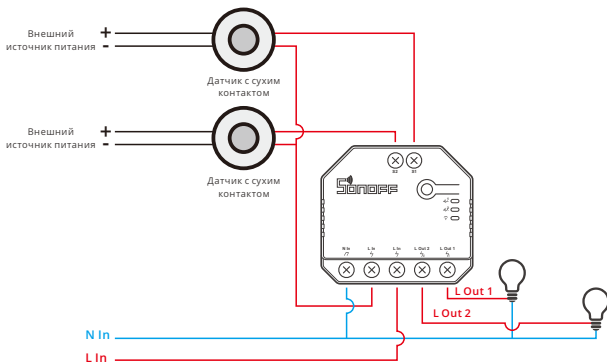

- ⚠ Убедитесь, что провод нейтрали (ноль) и провод под напряжением (фаза) подключены.
- ⚠ Если к S1/S2 не подключен физический выключатель света, то устройство по-прежнему исправно работает.
- ⚠ Если S1/S2 подключен к физическому выключателю света, для выбора нормального использования необходим соответствующий рабочий режим в eWeLink APP.

3. Скачать приложение

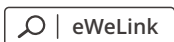

Android™ & iOS

4. Включить

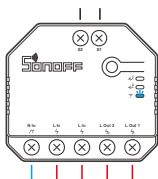

После первого включения устройство перейдет в режим сопряжения Bluetooth, светодиодный индикатор Wi-Fi начнет мигать в режиме «два раза коротко, один раз длинно».

⚠ Устройство выйдет из режим сопряжения Bluetooth, если сопряжение не будет выполнено в течение 3 минут. Если нужно войти снова, нажмите и удерживайте кнопку конфигурации 5 секунд, пока индикатор Wi-Fi не изменится по очереди на два коротких и одно длинное мигание, затем отпустите.

5. Добавить устройство



Коснитесь «+» и выберите «сопряжения Bluetooth», затем выполняйте действия после появления подсказки в приложении.

Технические характеристики

Модель	DUALR3
входной	100-240В пер. 50/60Гц 15А Макс.
выходной	100-240В пер. 50/60Гц
Макс. нагрузка	2200W/10A/кажд 3300W/15A/Всего
двигателя нагрузка	10-240W/1A
Стандарт Wi-Fi	IEEE 802.11 b/g/n 2.4GHz
Операционные системы	Android & iOS
Число блоков	2
Рабочая температура	-10°C~40°C
Материалы	PC V0
Размеры	54x49x24 мм

Знакомство с изделием

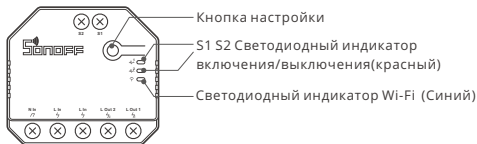

⚠ Вес устройства составляет менее 1 kg.

Рекомендуется устанавливать устройство на высоте менее 2 м.

Инструкция режима светодиодного индикатора

Режим светодиодного индикатора	Описание режима
Мигает голубой светодиодная лампочка (один длинный и два коротких)	Режим быстрого сопряжения
светодиодная синего цвета всегда горит	Устройство успешно подключено
светодиодная синего цвета быстро мигает	Режим совместимого соединения
светодиодная синего цвета быстро мигает один раз	Невозможно найти роутер
светодиодная синего цвета быстро мигает два раза	Успешное подключение к маршрутизатору, но серверу не подключен.
светодиодная синего цвета быстро мигает три раза	Обновление

Режим работы

После успешного сопряжения из режима выключателя, двигателя и счетчика выберите соответствующий режим на основе подключенного устройства. Пожалуйста, ознакомьтесь с подробной инструкцией по режимам работы в приложении eWeLink.

Функции

Данное устройство – это умный переключатель Wi-Fi с контролем мощности, позволяющий дистанционно включать / выключать устройство, планировать его включение / выключение или делиться им с семьей для совместного управления.



Управ. прилож.



Расписания



Доступ д/управл.



Смарт-сюжеты



Статус синхр.



Мониторинг
мощности



Защита от
перегрузки



Регулировка



Режим
включения



Управл. пров. сетью

Переключить сеть

Если Вам необходимо переключить сеть, удерживайте кнопку сопряжения в течение 5 с. Когда светодиодный индикатор Wi-Fi изменится на цикл из двух коротких и одного длинного мигания, отпустите. Устройство перейдет в режим быстрого сопряжения, после чего Вы можете снова выполнить сопряжение.

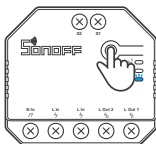

Сброс до заводских настроек

Удаление устройства в приложении eWeLink означает, что Вы восстанавливаете его до заводских настроек.

Стандартные проблемы

В: Почему устройство не подключается к сети?

О: Для подключения нового устройства к сети Wi-Fi и Интернету требуется 1-2 минуты. Если устройство не подключается к сети дольше, определить причину проблемы можно по статусу синего индикатора Wi-Fi. Возможные варианты:

1. Синий индикатор Wi-Fi быстро мигает раз два секунды, что означает, что коммутатору не удалось подключиться к вашей сети Wi-Fi:
 - ① Возможно, вы неправильно ввели пароль от сети Wi-Fi.
 - ② Возможно, расстояние между коммутатором и вашим роутером слишком велико либо окружение создает помехи. Попробуйте приблизить коммутатор к роутеру.
 - ③ Сеть Wi-Fi 5G не поддерживается, устройство поддерживает только беспроводную сеть 2,4 ГГц.
 - ④ Возможно, открыта фильтрация MAC-адреса. Отключите ее.

Если ни один из перечисленных методов не устранил проблему, можно включить мобильную сеть для передачи данных на телефоне и создать точку доступа Wi-Fi, после чего снова добавить устройство.

2. Синий индикатор быстро мигает два раз два секунды, что означает, что устройство подключено к сети Wi-Fi, но не подключилось к серверу.

Убедитесь, что ваша сеть работает стабильно. Если ситуация с двойным быстрым миганием возникает часто, это указывает на нестабильную сеть, а не на неполадки в работе изделия. Если сеть работает нормально, попробуйте выключите и перезапустите коммутатор.

Instrução de Operação

1. Desligar

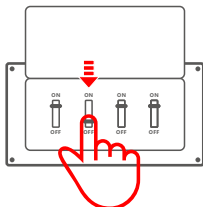

⚠ Para evitar choques elétricos, por favor consulte o seu distribuidor ou um profissional qualificado para auxiliar na instalação e reparo. Por favor não toque no painel durante o uso.

2. Instruções de instalação

Modo motor:

① Interruptor momentâneo:

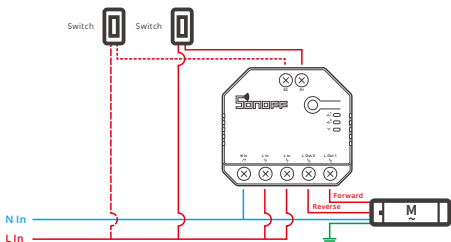

⚠ Conecte-se a S1 ou S2 para controle inteligente dos dispositivos conectados; conecte-se a S1 e S2 para controle inteligente bidirecional

② Interruptor momentâneo de relé duplo/Interruptor de luz oscilante de 3 saídas:

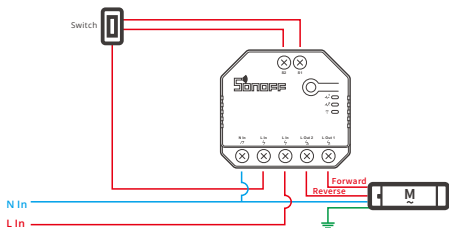

Instrução para instalação de lâmpadas:

- ① Para habilitar o controle de relé duplo, S1 e S2 são necessários para conectar a chave de botão no modo de pulso ou a chave oscilante no modo de borda:

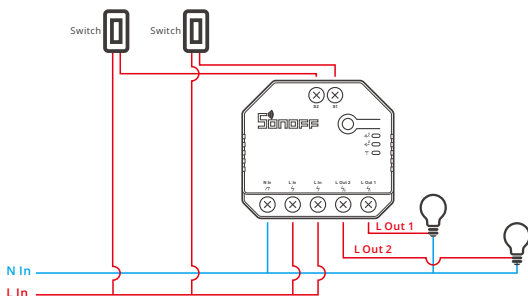

- ② Conecte os interruptores SPDT no modo de borda para alcançar o controle bidirecional duplo:

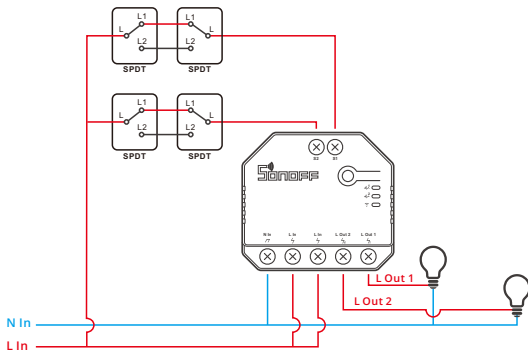

③ Conecte os sensores de contato seco no seguinte modo:

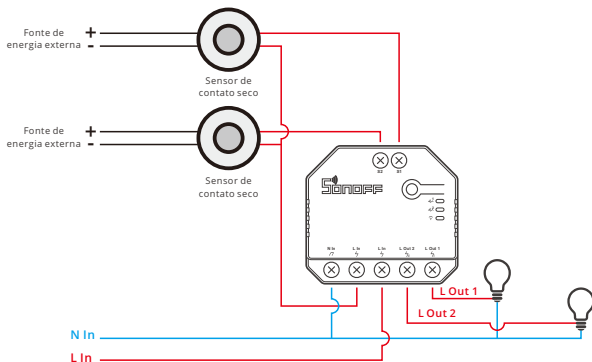

- ⚠ Certifique-se de que os cabos neutro e fase estejam conectados corretamente.
- ⚠ O dispositivo ainda funciona normalmente se nenhum interruptor de luz física estiver conectado a S1 / S2.
- ⚠ Se S1 / S2 estiver conectado a um interruptor de luz físico, o modo de trabalho correspondente é necessário no eWeLink APP para selecionar para uso normal.

3. Baixe o APP

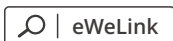

Android™ & iOS

4. Ligue

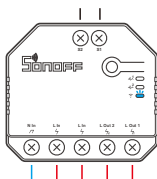

Após ligar o aparelho entrará em modo de emparelhamento Bluetooth durante o primeiro uso. O indicador LED Wi-Fi mudará para um ciclo de dois flashes curtos e um longo.

⚠ O aparelho irá sair do modo de emparelhamento Bluetooth se a conexão com o Wi-Fi não for feita em até 3 minutos. Se você queira entrar nesse modo, por favor pressione botão de emparelhamento 5 s até que o indicador LED do Wi-Fi mude para um círculo de dois flashes curtos e um longo em seguida solte.

5. Adicione o aparelho



Toque "+" e selecione "Emparelhamento Bluetooth" então prossiga seguindo as instruções do aplicativo.

Parâmetros do produto

Modelo	DUALR3
Entrada	100-240V AC 50/60Hz 15A Máx.
Saída	100-240V AC 50/60Hz
Carga Máx.	2200W/10A/Grupo 3300W/15A/Total
Carga motor	10-240W/1A
Wi-Fi	IEEE 802.11 b/g/n 2.4GHz
Sistema de operação	Android & iOS
Número de saídas	2
Temperatura de trabalho	-10°C~40°C
Material	PC V0
Dimensão	54x49x24mm

Introdução ao produto

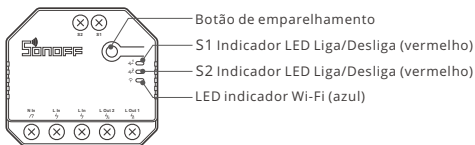

- ⚠ O peso do dispositivo é inferior a 1 kg.
Recomenda-se uma altura de instalação inferior a 2 m.

Instruções do status do indicador LED Wi-Fi

Status do indicador LED	Descrição de status
LED azul Piscando (um flash longo e dois curtos)	Modo de pareamento rápido
LED azul acesa	O dispositivo foi conectado com sucesso
LED azul pisque rapidamente	Modo de pareamento compatível
LED azul pisca rapidamente uma vez	Não foi possível encontrar o roteador
LED azul pisca rapidamente duas vezes	Conectou-se ao roteador, mas falhou ao se conectar ao servidor
LED azul pisca três vezes rapidamente	Atualizando

Modo de trabalho

Após o emparelhamento, selecione o modo correspondente entre os modos interruptor, motor e medidor de acordo com o dispositivo conectado. Por favor, verifique as instruções detalhadas para os modos de trabalho no aplicativo eWeLink.

Funções

Este dispositivo é um interruptor inteligente Wi-Fi com monitoramento de energia que permite ligar / desligar dispositivos remotamente, programá-los para ligar / desligar ou compartilhá-lo com sua família para controlar juntos.



Controle pelo aplicativo



Programador de tempo



Compartilhar controle



Cenas inteligentes



Status de sincronização



Monitoramento de energia



Proteção de sobrecarga



Modo de avanço



Estado de inicialização



Controle LAN

Mudar rede

Se você precisar alterar a rede, pressione e segure o botão de emparelhamento por 5s até que o indicador LED Wi-Fi mude em um ciclo de duas piscadas curtas e uma longa e solte, então o dispositivo entra no modo de emparelhamento rápido e você pode emparelhar novamente.

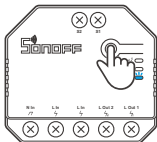

Redefinição de fábrica

Excluir o dispositivo no aplicativo eWeLink indica que você o restaurou para a configuração de fábrica.

Problemas comuns

Q: Por que o dispositivo fica "OFFLINE"?

R: O novo dispositivo adicionado precisa de 1-2 minutos para se conectar ao roteador e Wi-Fi. Se continuar offline por um longo tempo, por favor verifique o problema pelo indicador Wi-Fi azul:

1. O indicador Wi-Fi azul pisca uma vez por dois segundos: significa que o dispositivo falhou ao se conectar ao seu Wi-fi

- ① Talvez tenha sido inserida a senha incorreta.
- ② Talvez o seu dispositivo esteja muito longe do seu roteador ou há algo causando interferências, considere aproximar-se do roteador. Se falhar, por favor adicione novamente.
- ③ O dispositivo não suporta Wi-Fi 5G, somente rede 2.4GHz.
- ④ Talvez o filtro do endereço MAC esteja ativado. Por favor o desative.

Se nenhum dos métodos acima resolveu o problema, você pode através do seu celular criar um ponto de Wi-Fi e adicione o dispositivo novamente.

2. Indicador azul pisca duas vezes por dois segundos: significa que o dispositivo se conectou ao Wi-Fi, mas falhou em se conectar ao servidor.

Certifique-se de que a sua rede esteja estável. Se o indicador piscar duas vezes com frequência significa que sua rede está instável e não é um problema do produto. Se a internet está normal, tente desligar da energia e reinicie o dispositivo.

FCC Warning

Changes or modifications not expressly approved by the party responsible for compliance could avoid the user's authority to operate the equipment.

This device complies with part 15 of the FCC Rules. Operation is subject to the following two conditions: (1) This device may not cause harmful interference, and (2) this device must accept any interference received, including interference that may cause undesired operation.

FCC Radiation Exposure Statement:

This equipment complies with FCC radiation exposure limits set forth for an uncontrolled environment. This equipment should be installed and operated with minimum distance 20cm between the radiator & your body. This transmitter must not be co-located or operating in conjunction with any other antenna or transmitter.

Note:

This equipment has been tested and found to comply with the limits for a Class B digital device, pursuant to part 15 of the FCC Rules. These limits are designed to provide reasonable protection against harmful interference in a residential installation. This equipment generates, uses and can radiate radio frequency energy and, if not installed and used in accordance with the instructions, may cause harmful interference to radio communications. However, there is no guarantee that interference will not occur in a particular installation. If this equipment does cause harmful interference to radio or television reception, which can be determined by turning the equipment off and on, the user is encouraged to try to correct the interference by one or more of the following measures:

- Reorient or relocate the receiving antenna.
- Increase the separation between the equipment and receiver.
- Connect the equipment into an outlet on a circuit different from that to which the receiver is connected.
- Consult the dealer or an experienced radio/TV technician for help.

For FCC:

Frequency range

Wi-Fi: 2412-2462MHz BT: 2402-2480MHz

Maximum RF output power of the product

Wi-Fi: 17.85dBm BT: -1.90dBm

For CE RED:

Frequency range

Wi-Fi: 2412-2472MHz BT: 2402-2480MHz

Maximum RF output power of the product

Wi-Fi: 18.36dBm BT: 3.93dBm (Inclusion antenna gain)

RF exposure

RF exposure information: The Maximum Permissible Exposure (MPE) level is calculated based on a distance of $d=20$ cm between the device and the human body. To maintain compliance with the RF exposure requirement, a separation distance of 20 cm between the device and the human should be maintained.



Shenzhen Sonoff Technologies Co., Ltd.

1001, BLDG8, Lianhua Industrial Park, shenzhen, GD, China
ZIP code: 518000 Website: sonoff.tech

MADE IN CHINA

