

# CYCLOTRON

USER MANUAL

[www.sunslice-solar.com](http://www.sunslice-solar.com)

## IN THE BOX

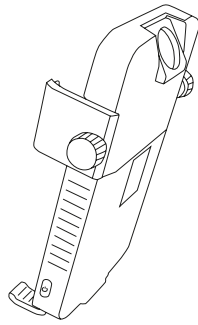

Cyclotron

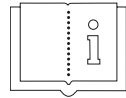

User Manual

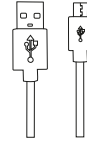

Micro-USB Cable

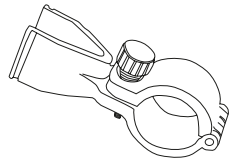

Bike Plier

## EXTRA ACCESSORIES

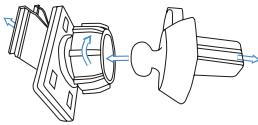

Car Plier

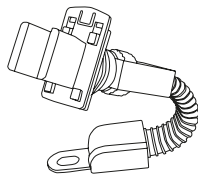

Motorbike Plier

## COMPATIBLE WITH



GPS



SMARTPHONE

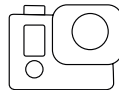

GoPro

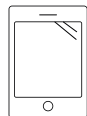

TABLET



CAMERA

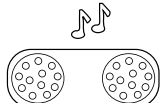

RADIO



USB

## KEY FEATURES

- WIRELESS CHARGING
- EASY ANTI-THEFT CLIP SYSTEM
- SHOCK-RESISTANT
- WATER-RESISTANT
- POWERFUL HEADLAMP
- HIGH EFFICIENCY INTEGRATED BATTERY
- SPECIALISED MOUNTING SYSTEMS
- SECURE AND ADJUSTABLE CLAMPING SYSTEM

## II. SPECIFICATIONS

BATTERY	5'000 mAh
BATTERY OUTPUT	5V / 2A - USB 5V / 1A WIRELESS
BATTERY INPUT	5V / 1A - USB
LED HEADLAMP	250 Lumen
WEIGHT	245g
DIMENSIONS	100 x 152 x 35 mm
CHARGE STATUS	4 LED indicators
ACCESSORIES	Bike & Motorbike & Scooter & Car plier

## III. CHARGE THE CYCLOTRON AND YOUR DEVICE

USB-OUTPUT  
(to charge your device, connect your USB-cable here)

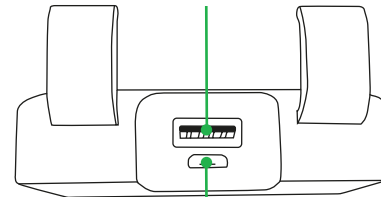

micro-USB INPUT  
(to charge the Cyclotron connect the USB-cable here)

## IV. PRODUCT OVERVIEW

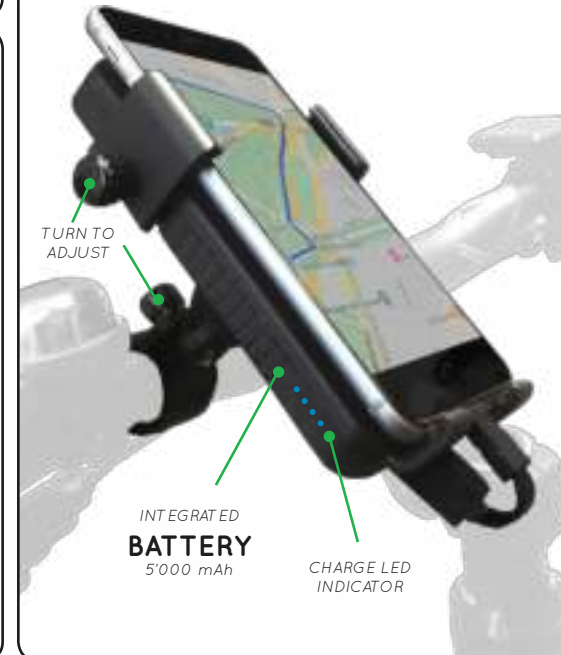
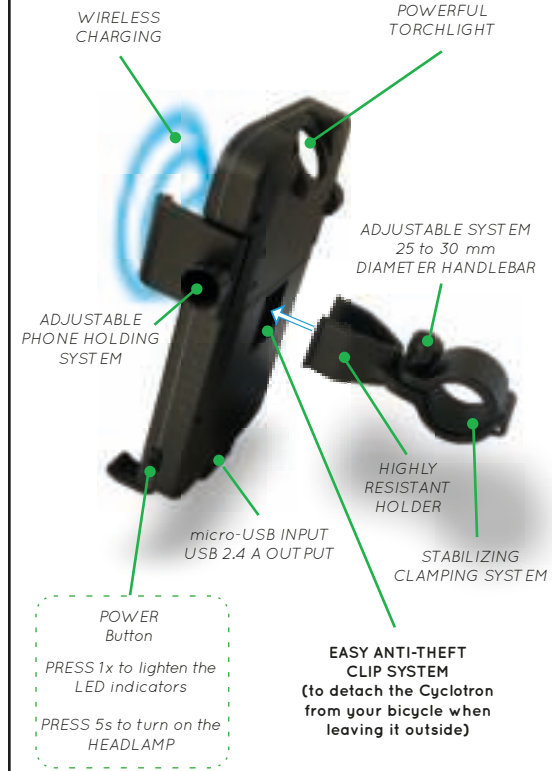

## I. INTRODUCTION

Thank you for your purchase. We hope you will have a great experience using the Sunslice Cyclotron.

The Cyclotron has been developed with the ultimate goal to give people access to energy everywhere.



This manual contains important safety and product care information, as well as step-by-step instructions for using your Cyclotron. To get the greatest benefit from your purchase, we recommend you read the manual thoroughly, and keep it in a safe place in case you need to refer to it later.

Geoffroy & Henri

## V. INSTALLATION AND ACCESSORIES

The Sunslice Cyclotron is equipped with a universal fixing system, compatible with a large range of handlebar diameters.

To fix the universal system to the handlebar, open the fixing cylinder by loosening the screw, put it around the handlebar and consequently tighten the screw cautiously. Then, put the clamping system into the hole at the back of the Cyclotron.

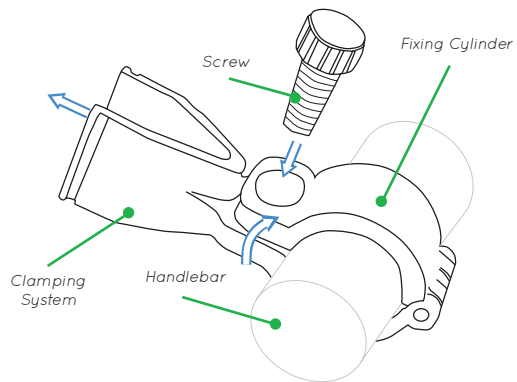

The fixing system is adjustable to different handlebar diameters by using the rubber anti-slip pads, included in the box. For optimal use, stick the shortest pads on the inner side of the fixing system and another longer pad on your handlebar. Choose the best pad thickness according to your handlebar diameter.

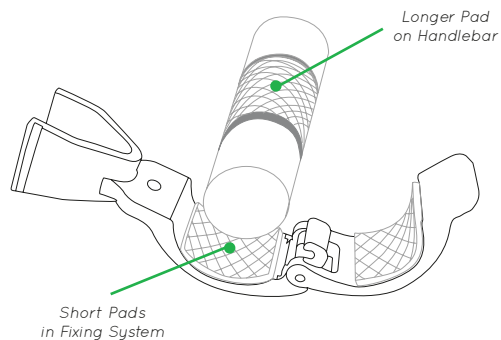

To attach the specialised motorbike system to your motorbike firmly, fix the metallic mouthpiece around the rear-view mirror as shown in the drawing hereunder.

To adjust the orientation of the Cyclotron, unscrew the clamping ring, adjust the system and followingly tighten the clamping ring firmly. Then, put the clamping system into the hole at the back of the Cyclotron.

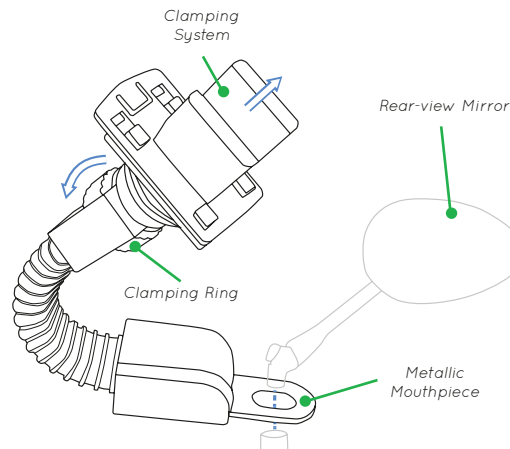

To assemble the specialised car vent mount, insert the small globe into the hole of the clamping part. Followingly, tighten the clamping ring, according to the desired orientation. Then, put the clamping system into the hole at the back of the Cyclotron. Finally, insert the fixing system into the car heater vent and choose the clamping position I or II.

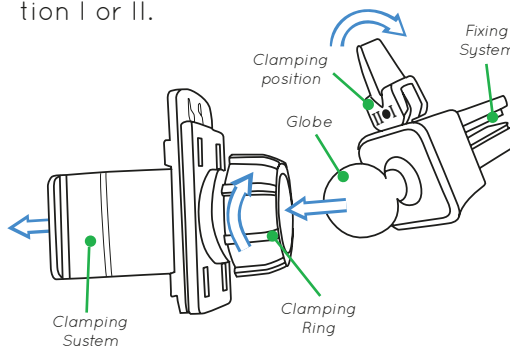

## VI. OUR WARRANTIES

### PREMIUM QUALITY

We select the finest materials to insure a high quality and durability for all of our products.

### PROTECTION CIRCUIT

The Sunslice Cyclotron is equipped with a voltage stabilising circuit to avoid damaging your devices.

### 2 YEARS WARRANTY

The Cyclotron has a 2 year warranty. In case something goes wrong, please contact us directly by email at :

[service@sunslice-solar.com](mailto:service@sunslice-solar.com)

PLEASE CONTACT US DIRECTLY



## VII. PRECAUTIONS

- Do not puncture, throw, drop, bend or modify your Sunslice Cyclotron.
- Do not leave the Sunslice Cyclotron out in the rain, keep away from water. Do not expose the Cyclotron to fire or excessive heat.
- Do not short-circuit the battery with lead or any metal objects.
- Please make sure the Cyclotron and your phone are surely attached to your bike before beginning each ride.
- Avoid all-terrain riding or bumpy roads with the Cyclotron.
- Please fully charge the power bank after a long period of storage as it may discharge slowly with time.
- Do not use excessive force when fixing the Cyclotron and when tightening your mobile device to the Cyclotron.
- Do not disassemble the charger or change its structure in any way.
- Stop using the Sunslice Cyclotron if it generates unusual smell, heating, distortion or any other abnormality.

You are welcome on our website to learn more about our products.

[www.sunslice-solar.com](http://www.sunslice-solar.com)

Sunslice SRL  
Chemin du Cyclotron 6,  
1348 Louvain-la-Neuve, Belgium