

1

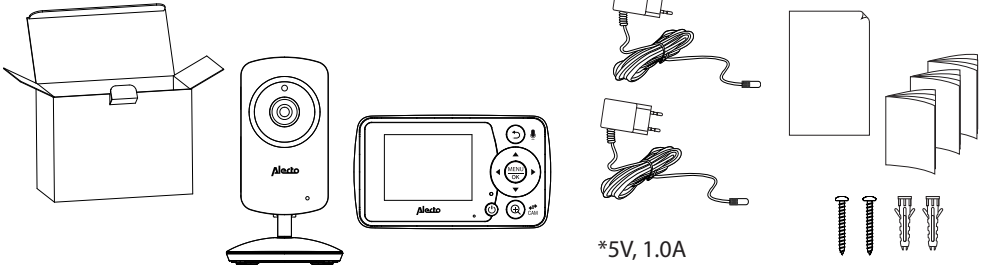

2

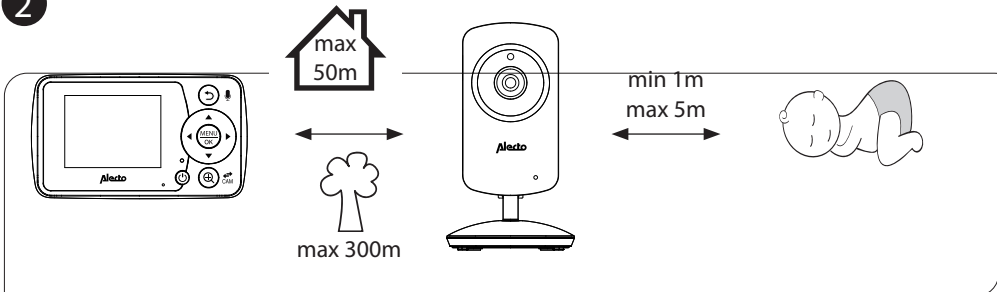

3

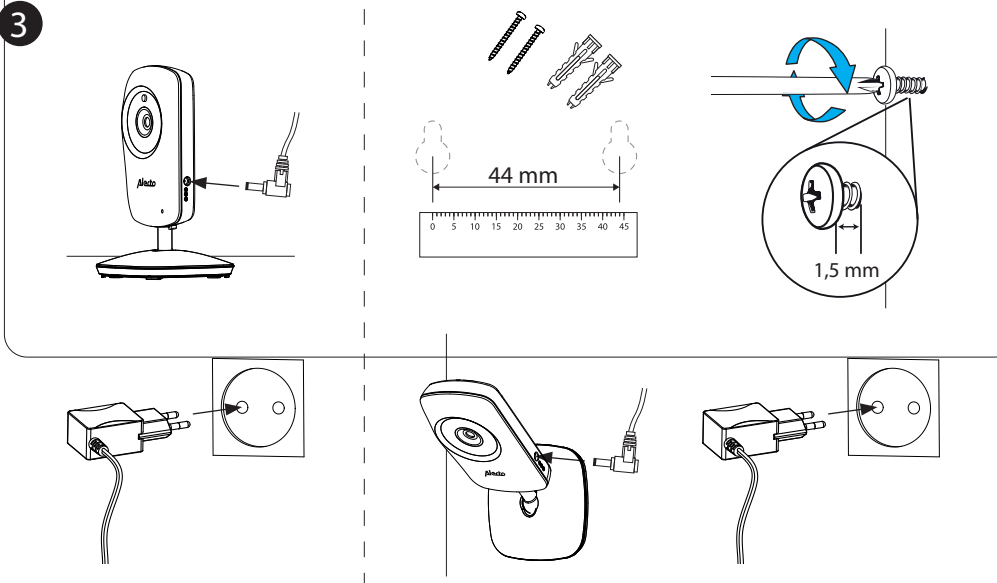

4

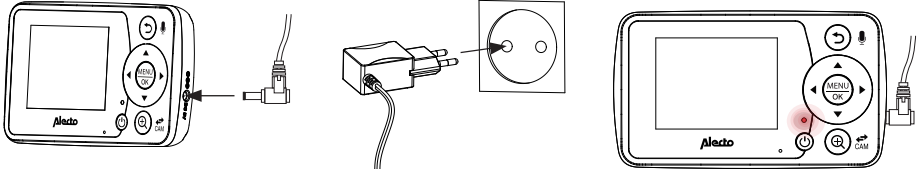

5

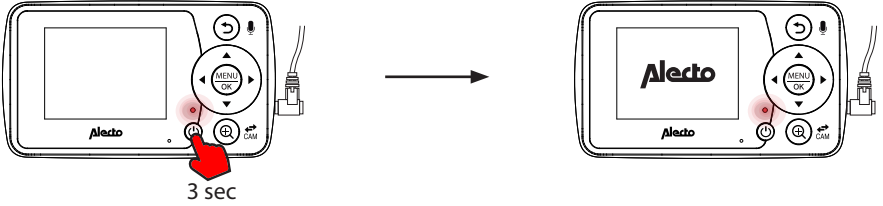

6

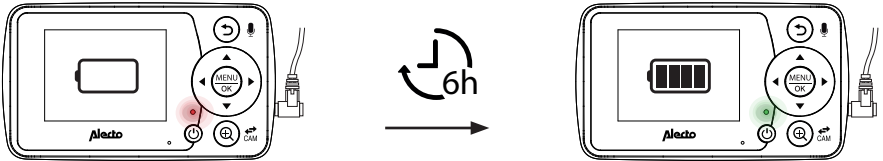

7

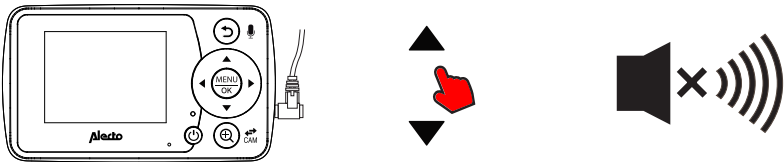

8

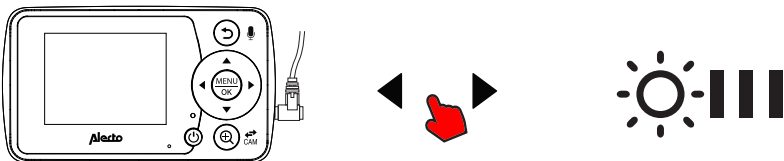

DECLARATION OF CONFORMITY

Hereby, Commax declares that the radio equipment type Alecto DVM-64 is in compliance with directive 2014/53/EU.  
 The full text of the EU declaration of conformity is available at the following internet address:  
<http://DOC.hesdo.com/DVM-64-DOC.pdf>

Commax B.V.  
 Wiebachstraat 37  
 6466NG Kerkrade  
 The Netherlands