

1

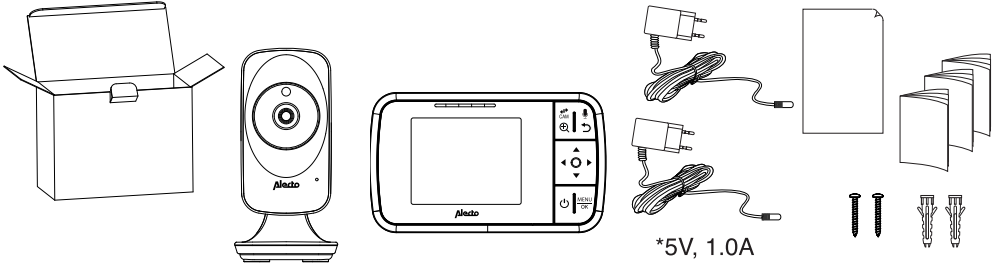

2

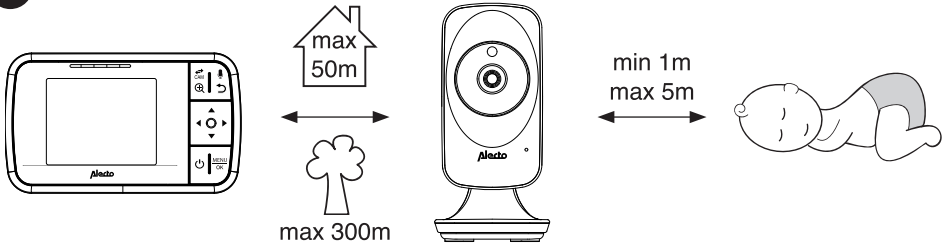

3

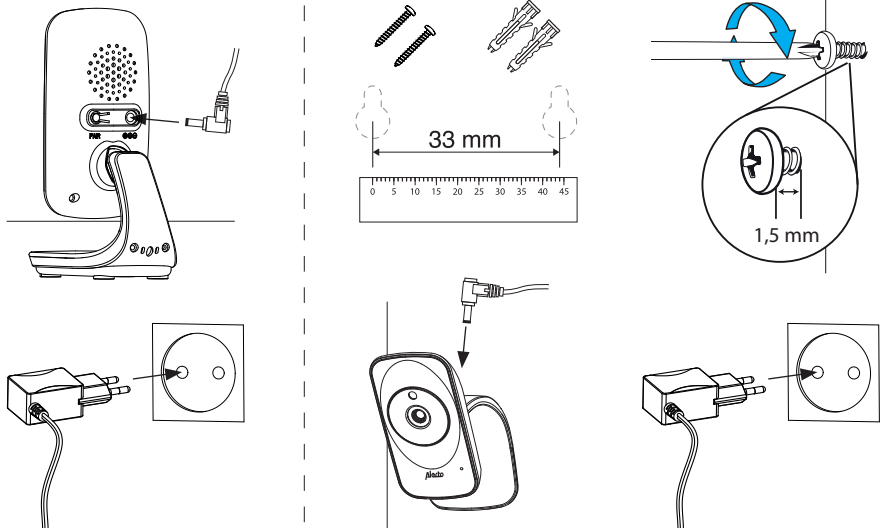

4

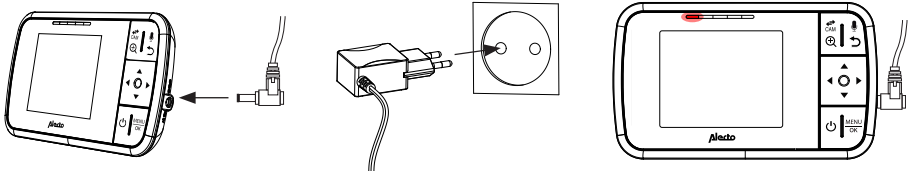

5



6

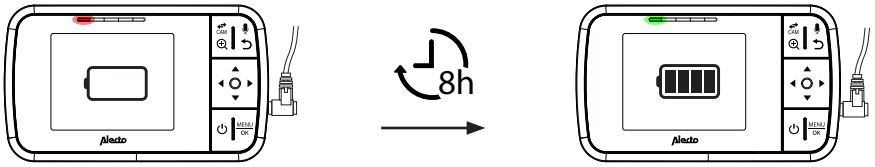

7

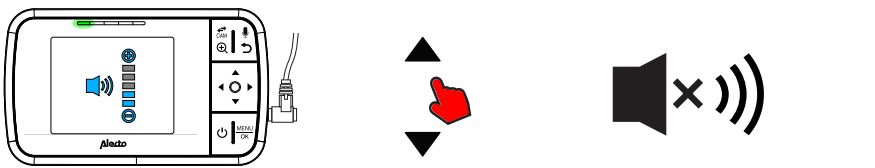

8

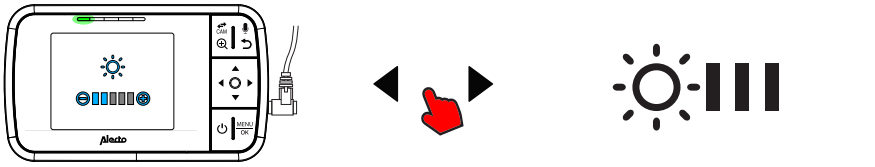

DECLARATION OF CONFORMITY

Hereby, Hesdo declares that the radio equipment type Alecto DVM135 is in compliance with directive 2014/53/EU.
 The full text of the EU declaration of conformity is available at the following internet address:
<http://DOC.hesdo.com/DVM135-DOC.pdf>