

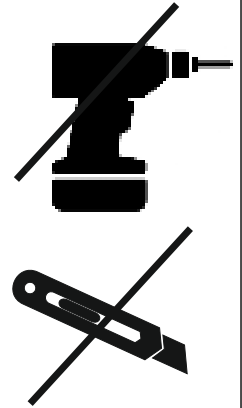

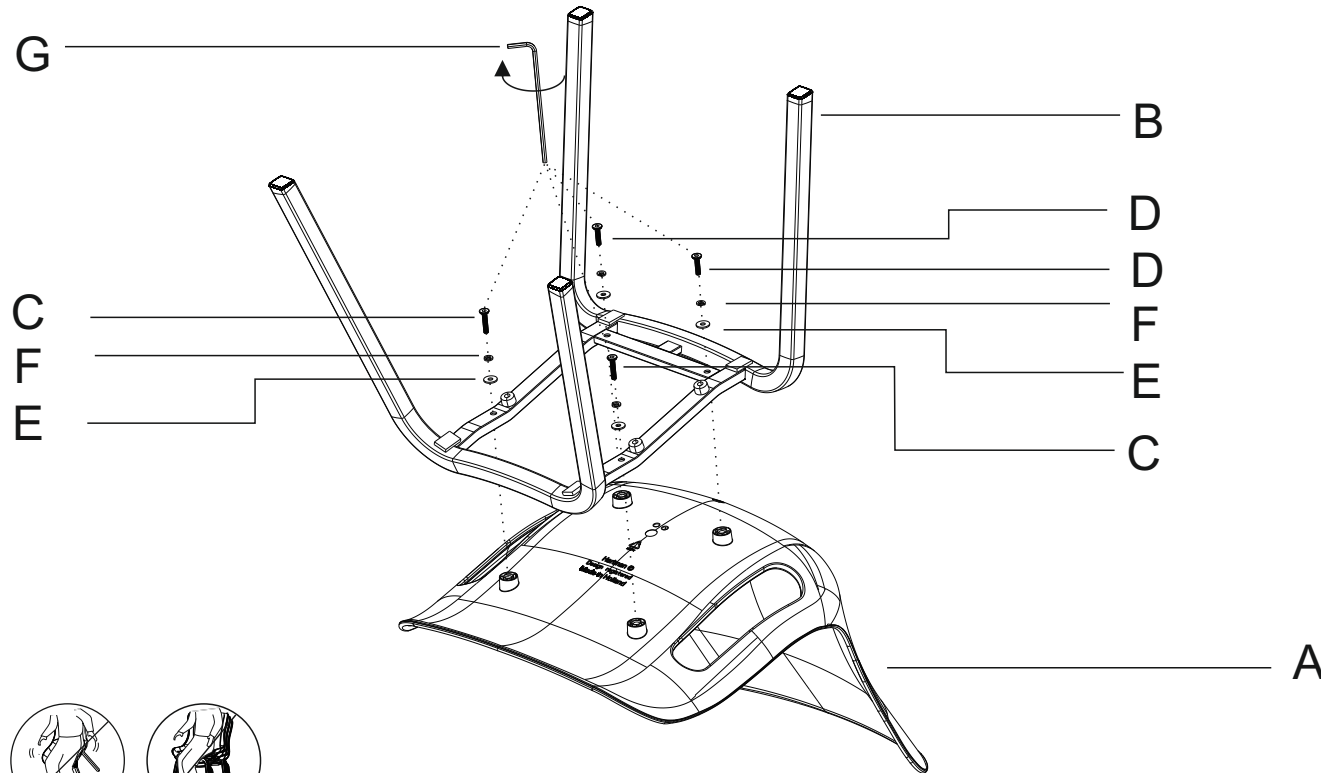

BEFORE ASSEMBLY, PLACE PRODUCT ON A CLEAN SURFACE  
 BITTE PRODUKT AUF EINEN WEICHEN, SAUBEREN UNTERGRUND LEGEN ZUM MONTIEREN  
 PLAATS HET PRODUCT OP EEN ZACHTE, SCHONE ONDERGROND T.B.V. MONTAGE  
 POUR ASSEMBLER, POSEZ LE PRODUIT SUR UNE SURFACE DOUCE ET PROPRE  
 PARA MONTAJE, PONE EL PRODUCTO A UNA SUPERFICIE SUAVE Y LIMPIA

# Hartman®

**SOPHIE PRO ELEMENT**  
**ARTICLE CODE 21.684.XXX**

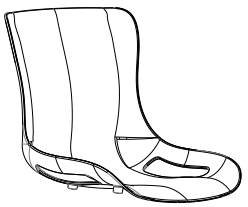
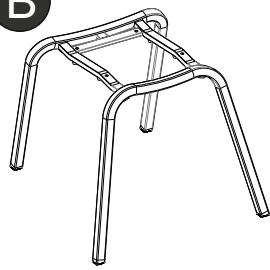

**Attention C and D are different lengths**

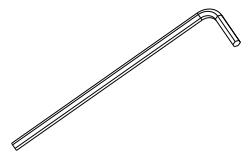
|  |  |  |   |  |  |   |
|--|--|--|---|--|--|---|
| <p><b>A</b></p>  <p>1</p> | <p><b>B</b></p>  <p>1</p> | <p><b>C</b></p> <p>M6x30</p>  <p>1</p> | <p><b>D</b></p> <p>M6x25</p>  <p>2</p> | <p><b>E</b></p> <p>M6</p>  <p>2</p> | <p><b>F</b></p> <p>M6</p>  <p>4</p> | <p><b>G</b></p>  <p>4</p> <p>1</p> |
|--|--|--|---|--|--|---|