

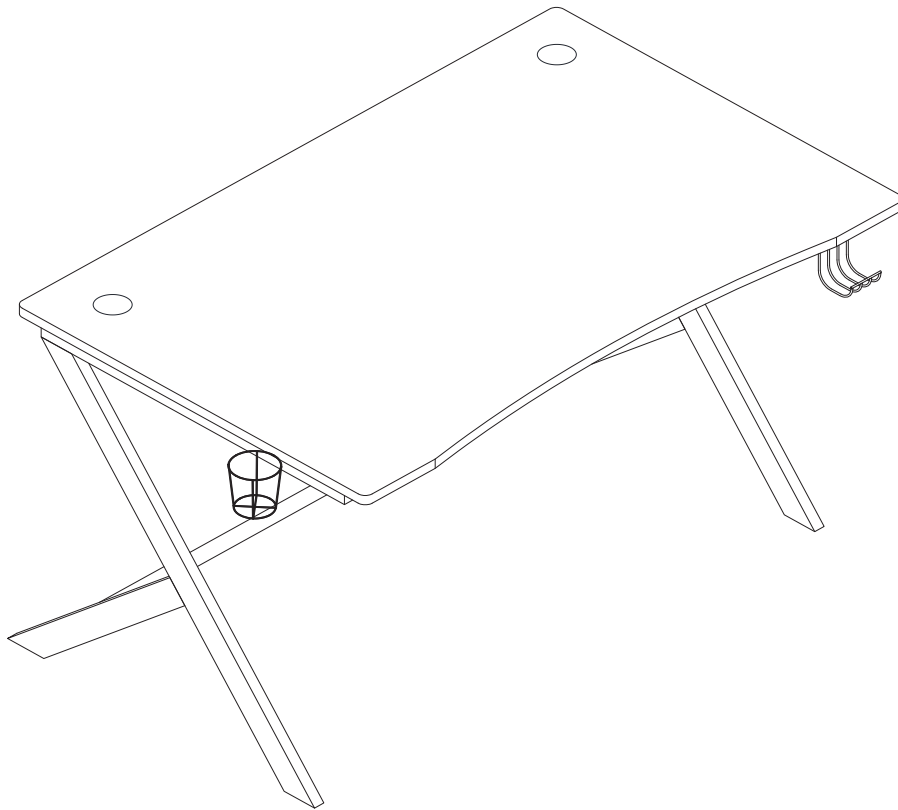

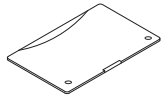





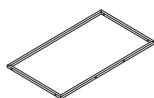

ASSEMBLY INSTRUCTIONS

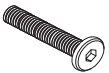

PARTS:

①		x1
② Left		x1
③ Right		x1
④		x1
⑤		x1
⑥		x2
⑦		x1
⑧		x1

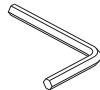
A. 6x12mm		x8
B. 6x40mm		x6
C. 6x60mm		x4
D. Foot		x4
E. Allen Wrench		x1

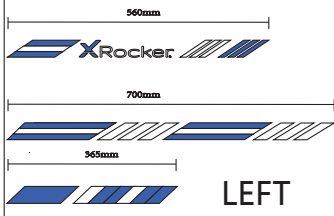

LEFT

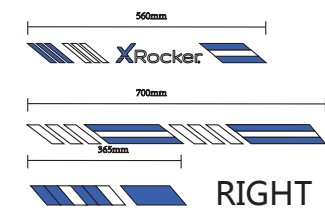

RIGHT

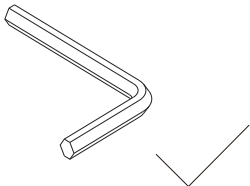
	YES		NO
---	-----	--	----

Attention: DO NOT TIGHTEN THE SCREWS UNTIL ALL PARTS ARE IN RIGHT POSITIONS.

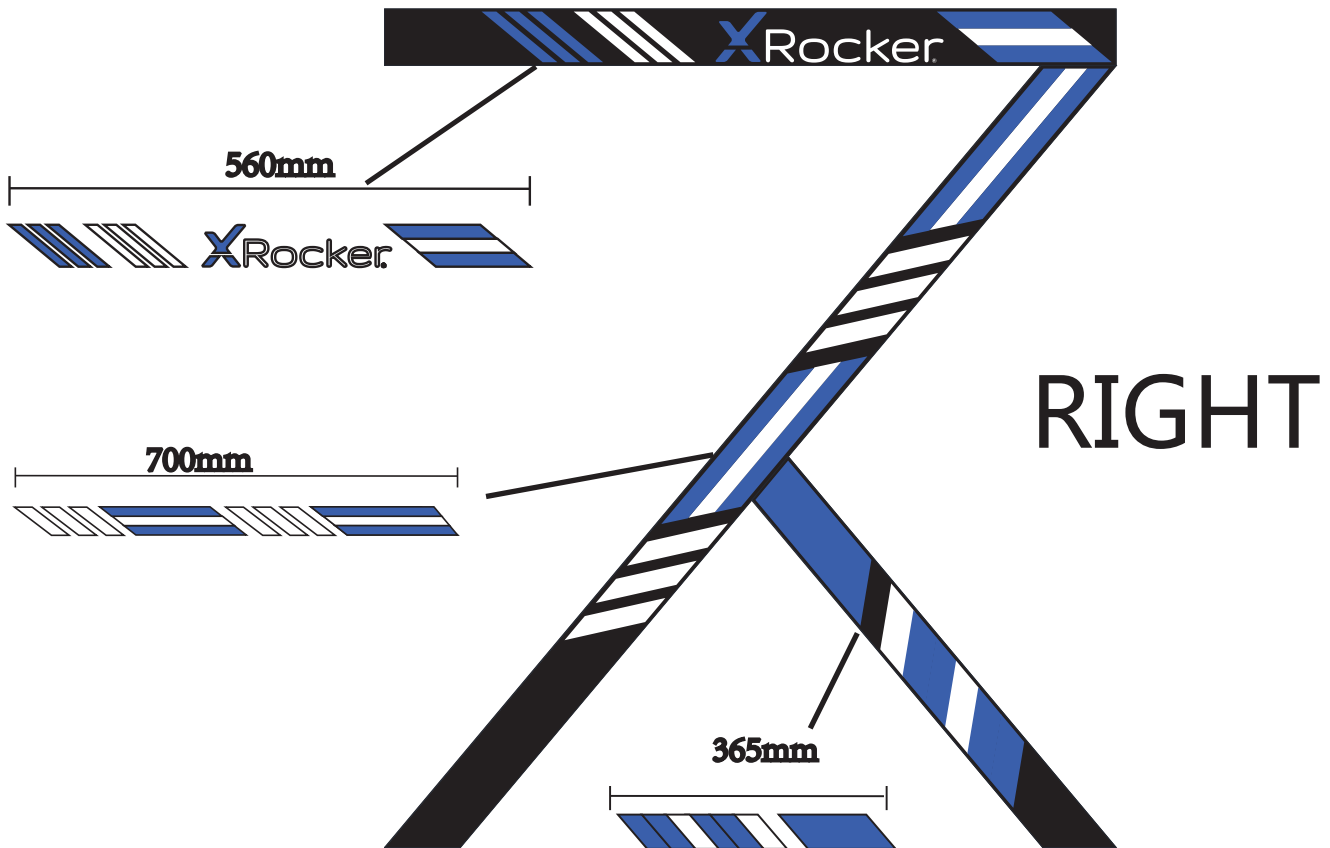
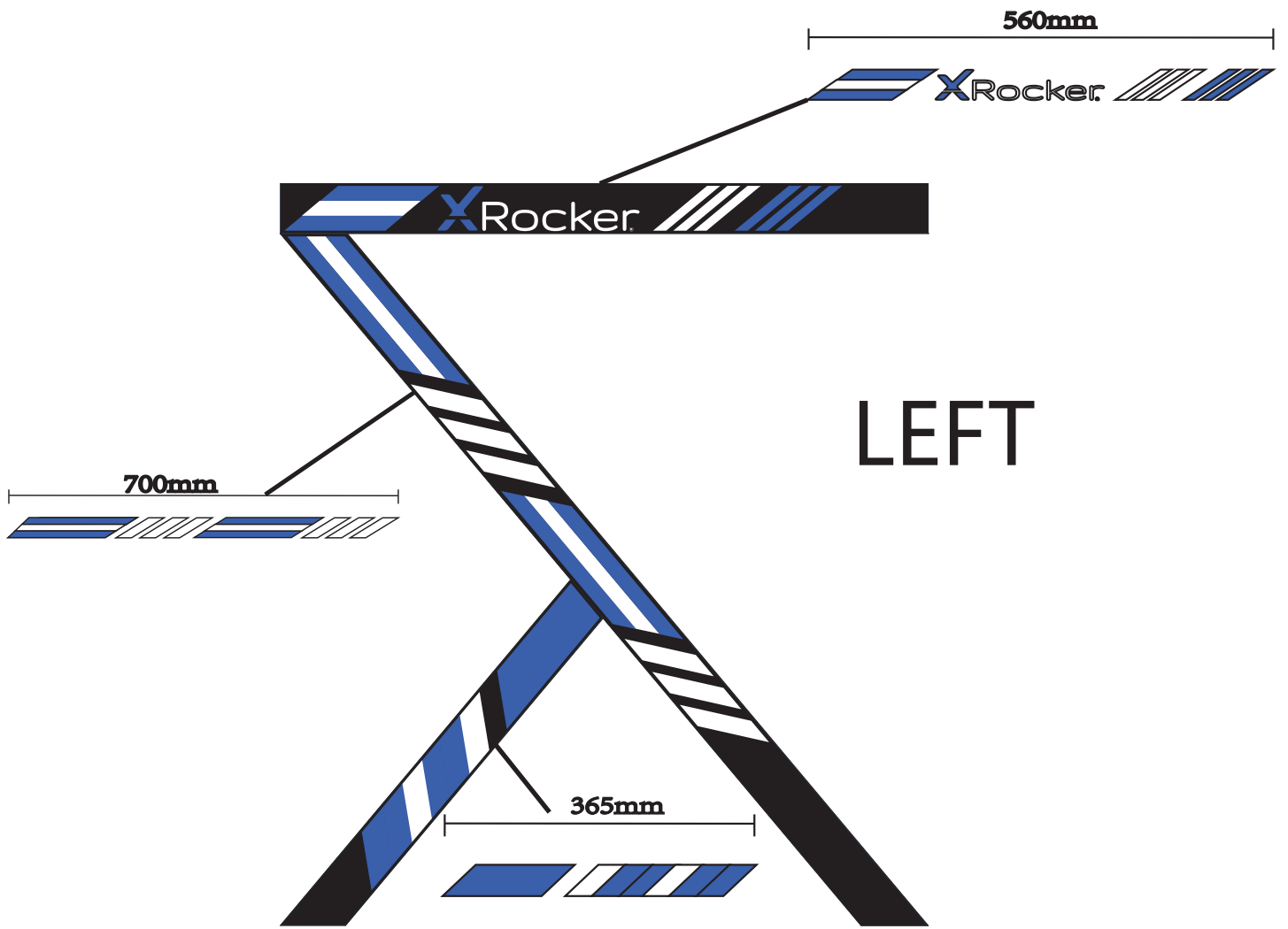

STEP 1

Attach Feet (D) to Left Stand (2) and Right Stand (3).

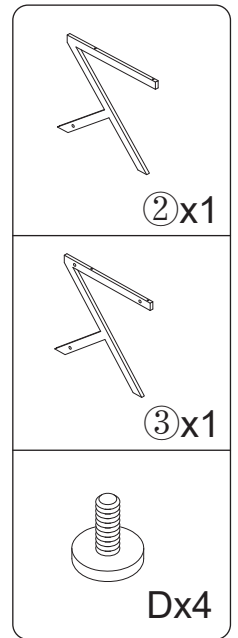
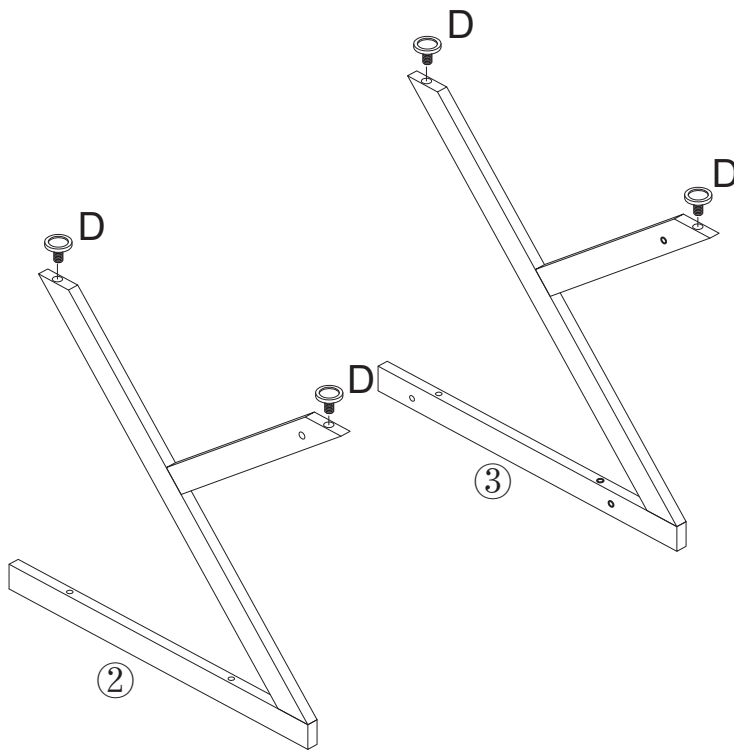

STEP 2

Attach Lower Bar (5) to Right Stand (3) and Left Stand (2) with Screws (B) (6x40mm) by Allen Wrench (E). Then attach Steel Frame (4) with Screws (B) (6x40mm) by Allen Wrench (E) as shown.

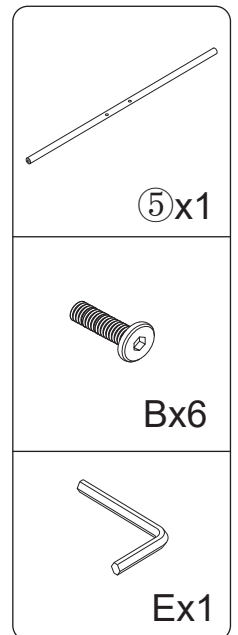
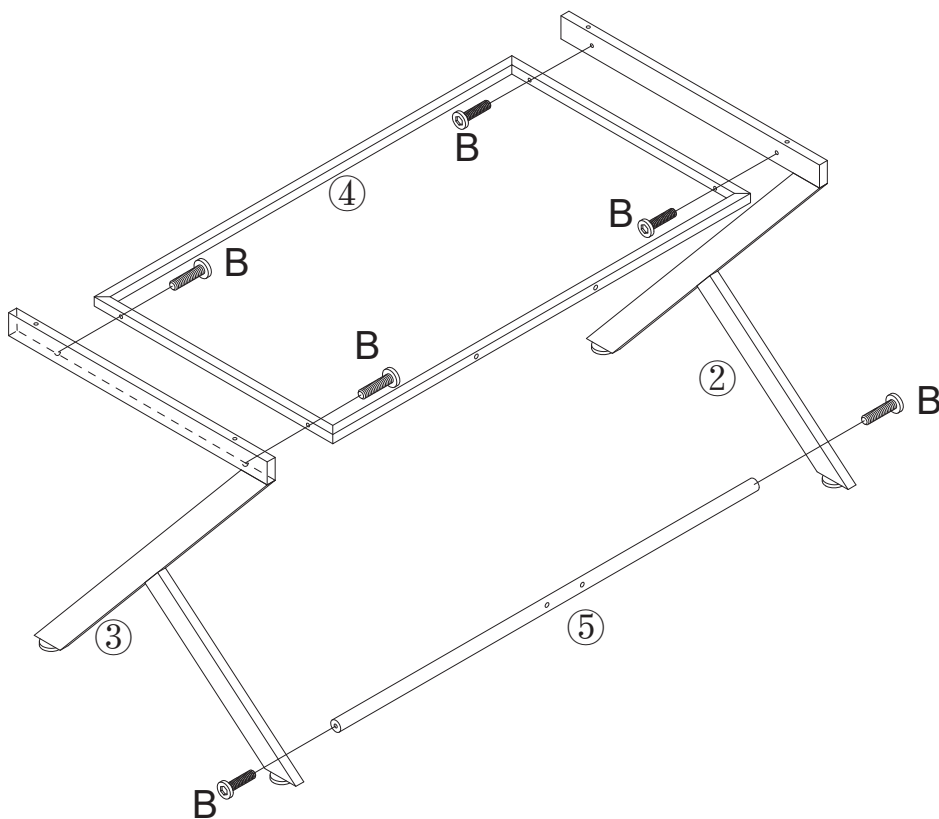

STEP 3

Attach two Support Bars (6) to Steel Frame (4) and Lower Bar (5) with Screws (A) (6x12mm) by Allen Wrench (E).

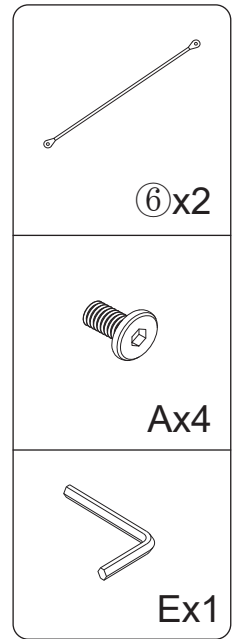
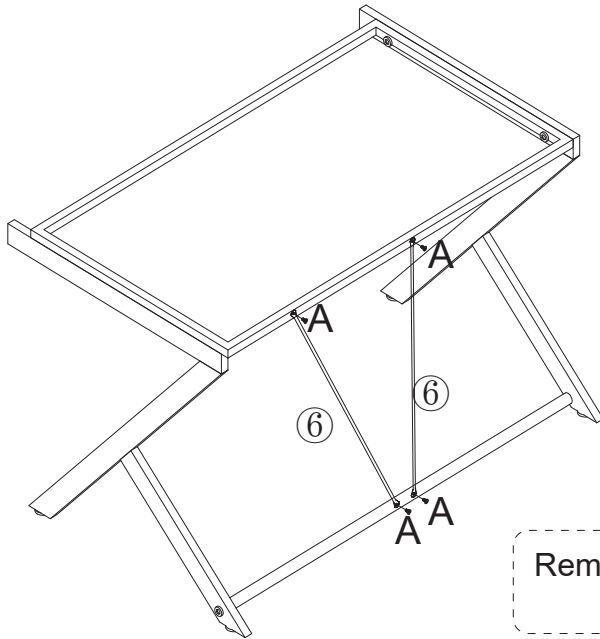

Remark: Turn the lower bar 5 to match the support bars 6.

STEP 4

Attach Headphone Holder (7) and Cup Holder (8) to Desktop (1) with Screws (A) (6x12mm) by Allen Wrench (E).

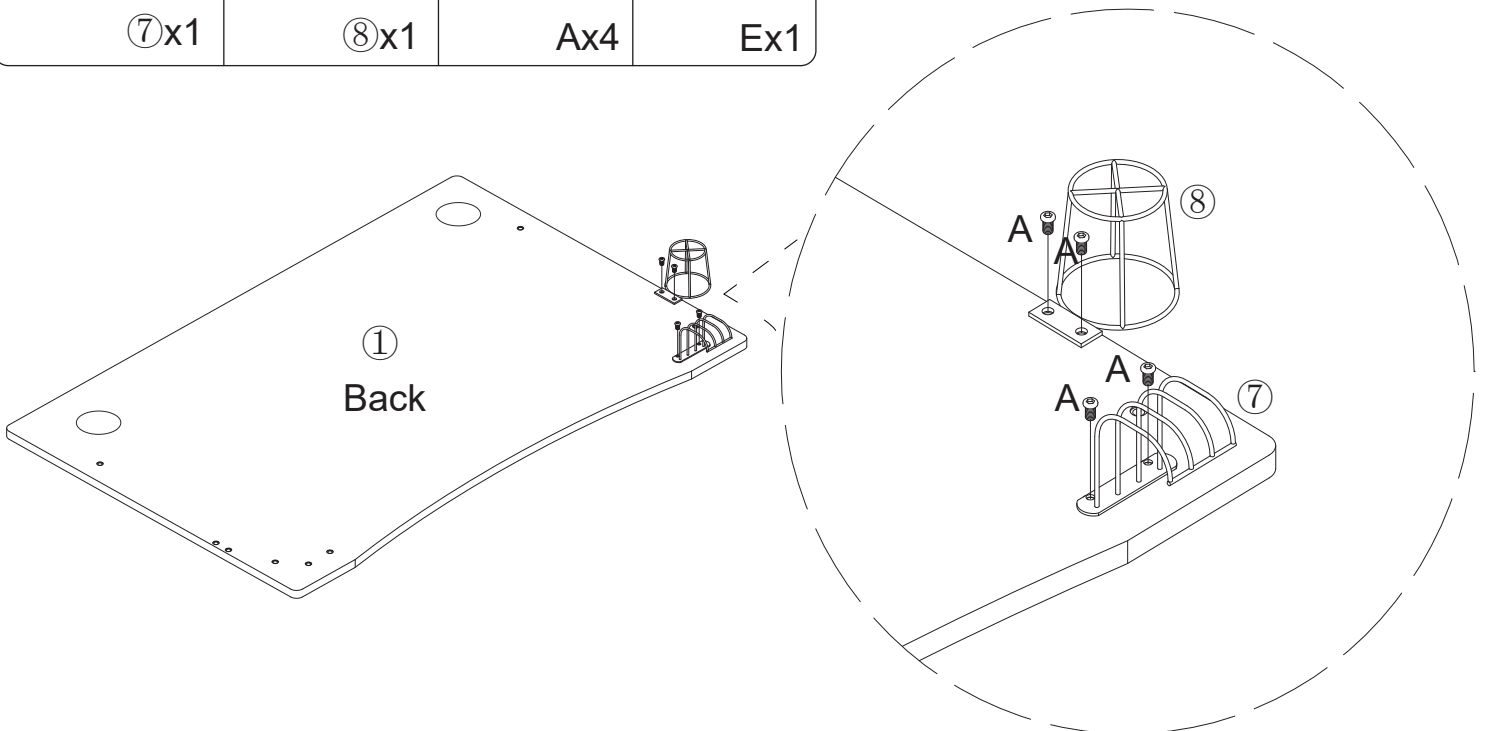
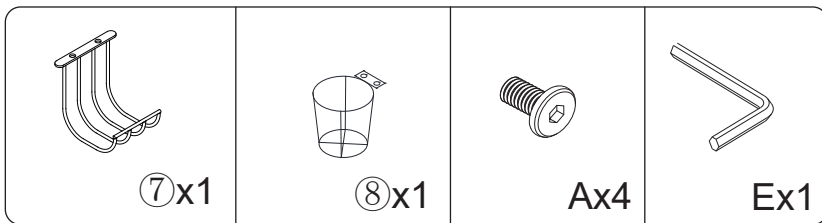

STEP 5

Attach Desktop ① to Left Stand ② and Right Stand ③ with Screws (C) (6x60mm) by Allen Wrench (E).

