

## Important information

### Safety

Ensure that your domestic mains supply voltage matches the voltage indicated on the identification sticker located at the back of your set. Where the mains plug or an appliance coupler is used as disconnect device, it shall remain readily operable. On certain models, the light indicator is located at the side of the TV set. The absence of a light indication at the front does not mean that the TV set is fully disconnected from the mains. To disconnect the TV set completely, the mains plug must be pulled out.

The TV set's components are sensitive to heat. The **maximum ambient temperature** should not exceed **35° Celsius**. Do not cover the vents at the back or sides of the TV set. Leave sufficient space around it to allow adequate ventilation. Install the appliance away from any source of heat (fireplace, etc.) or appliances creating strong magnetic or electric fields.

**Moisture** in rooms where the set is installed should not exceed **80%** humidity. Moving the set from a cold place to a warm one can cause condensation on the screen (and on some components inside the TV set). Let the condensation evaporate before switching the TV set on again.

### WARNINGS

This appliance is intended for domestic household use only and should not be used for any other application, such as for non-domestic use or in a commercial environment.

If the external flexible cable or cord of this product is damaged, it shall be replaced by the manufacturer or his service agent or a similar qualified person in order to avoid a hazard.

Leave more than 10cm clearance around the television to allow adequate ventilation. The ventilation should not be impeded by covering the ventilation openings with items, such as newspapers, table-cloths, curtains, etc.

The apparatus shall not be exposed to dripping or splashing and no objects filled with liquids, such as vases shall be placed on the apparatus.



To prevent the spread of fire, keep candles or other open flames away from this product at all times.



**WARNING:** To prevent injury, this apparatus must be securely attached to the floor/wall in accordance with the installation instructions.

**CAUTION:** Connect headphones with the volume set low and increase if required. Prolonged listening through headphones at high volume settings can result in hearing damage.

### Eye Fatigue

When using this product as a computer monitor, health and safety experts recommend short frequent breaks rather than occasional longer breaks. For example a 5-10 minute break after an hour of continuous screen work is considered to be better than a 15 minute break every 2 hours.

Do not use the monitor against a bright background or where sunlight or other bright light sources will shine directly onto the screen.

The  or **POWER** button on the TV set or the  button on the remote control can be used to switch it on and put it into standby mode. If you are **not going to be watching the TV for a lengthy period of time**, switch it off completely by removing the plug from the mains power socket.

During **thunderstorms**, we recommend that you disconnect the TV set from the mains and aerial so that it is not affected by electrical or electromagnetic surges that could damage it. For

this reason, keep the **mains and aerial sockets** accessible so they can be **disconnected**, if necessary.

**Unplug** the TV set immediately if you notice it giving off a **smell of burning or smoke**. You must never, under any circumstances, open the TV set yourself, as you run the risk of an **electric shock** in doing so.

### TV screen

The TV screen used in this product is made of glass. Therefore, it can break when the product is dropped or impacted upon by other objects.

The TV screen is a very high technology product, giving you finely detailed pictures. Occasionally, a few nonactive pixels may appear on the screen as a fixed point of blue, green or red. This does not affect the performance of your product.

### Care

Use a glass-cleaning product to clean the screen and a soft cloth and mild detergent to clean the rest of the set.

**Important:** Using strong detergents, alcohol-based and abrasive products may damage the screen.

Dust the vents at the back and sides regularly. Using solvents, abrasive or alcohol-based products could damage the TV set. If an object or liquid enters the appliance, unplug it immediately and have it checked by an authorized engineer. Never open the appliance yourself since this may put you at risk or damage the appliance.

### Hanging the TV set on the wall

**Warning: This operation requires two people.**

To ensure a safe installation, observe the following safety notes:

- Check that the wall can support the weight of the TV set and wall mount assembly.
- Follow the mounting instructions provided with the wall mount. For certain models, make sure to screw the hexagonal VESA wall mounting screw bosses (and screws) provided with the set into the nuts for the wall mount at the back of your set before your wall mounting.
- The TV set must be installed on a vertical wall.
- Make sure to use only screws suitable for the material of the wall.
- Make sure that the TV set cables are placed so that there is no danger of tripping over them.

All other safety instructions about our TV sets are also applicable here.

### Placing the TV on a table and other surfaces

Before setting up your television set, make sure that the surface you want to put the set on can support its weight.

Do not place the set on an unstable surface (e.g. moving shelf, very edge of a unit) and make sure that the front of the television set does not overhang the surface it is standing on.

To avoid TV from falling please fasten TV to the wall by using necessary screws (in Vesa wall mount holes), clamps, anchors to be bought separately. Install TV near to the wall to avoid falling backwards.

### Multi product user manual

The features described in this manual are common to most models. Some features may not be available on your TV and/or your TV may include features that are not described in this user manual. The illustrations in this manual may differ from the actual product. Please refer to the actual product.

### Information for Users on Disposal of Old Equipment and Batteries [European Union]



Products



**Pb**  
Battery

**Notice:**  
The sign Pb below the symbol for batteries indicates that this battery contains lead.

These symbols indicate that the electrical and electronic equipment and the battery with this symbol should not be disposed of as general household waste at their end-of-life. Instead, the products should be handed over to the applicable collection points for the recycling of electrical and electronic equipment as well as batteries for proper treatment, recovery and recycling in accordance with your national legislation and the Directive 2002/96/EC and 2006/66/EC.

By disposing of these products correctly, you will help to conserve natural resources and will help to prevent potential negative effects on the environment and human health which could otherwise be caused by inappropriate waste handling of these products.

For more information about collection points and recycling of these products, please contact your local municipal office, your household waste disposal service or the shop where you purchased the product.

Penalties may be applicable for incorrect disposal of this waste, in accordance with national legislation.

#### [Business users]

If you wish to dispose of this product, please contact your supplier and check the terms and conditions of the purchase contract.

#### [Other Countries outside the European Union]

These symbols are only valid in the European Union. If you wish to dispose of these items, please do so in accordance with applicable national legislation or other rules in your country for the treatment of old electrical equipment and batteries.

#### Dear Customer,

This apparatus is in conformance with the valid European directives and standards regarding electromagnetic compatibility and electrical safety.

TCL Operations Polska Sp. z o.o.  
ul. A. Mickiewicza 31/41  
96-300 Żyrardow, Poland

Email address: [zyeee@tcl.com](mailto:zyeee@tcl.com)

*Figures and illustrations in this User Manual are provided for reference only and may differ from actual product appearance. Product design and specifications may be changed without notice.*

Important information .....	1	Video .....	12
<b>Chapter 1 - Connections</b>		Time access .....	13
Connecting the power and antenna .....	4	Diagnostics on digital TV channels .....	13
DVD recorder, cable receiver .....	4	Reset shop .....	13
DVD player, home theatre system, PC, headphones...5		Customising the input settings .....	13
Blu-ray Disc player, HD game console &		Using Electronic programme guide .....	13
HD camcorder .....	5	PVR (Personal Video Recorder) .....	13
<b>Chapter 2 - Getting started</b>		Schedule list .....	14
Remote control functions .....	6	MHL (Mobile High-Definition Link) .....	14
Switching the TV on and off .....	7	Connecting MHL-compatible Device .....	14
		When using MHL .....	14
<b>Chapter 3 - Installing channels</b>		<b>Chapter 6 - Other information</b>	
Initial setup .....	8	Password in Parental Control .....	15
Performing an automatic channel search.....	8	Troubleshooting .....	15
<b>Chapter 4 - Using your TV</b>		Television specifications .....	15
Accessing channels .....	9	Operating Conditions .....	15
Watching connected devices .....	9	Storage Conditions .....	15
Volume .....	9	OSS Notice .....	15
Using TV menus .....	9		
Selecting menu language .....	9		
<b>Chapter 5 - Using more of your TV</b>			
Setting up your favourite channels .....	10		
ECO settings .....	10		
Audio description .....	10		
Using subtitles .....	10		
Turning on/off subtitles .....	10		
Enabling subtitle languages on digital TV channels	10		
Selecting a subtitle type on digital TV channels ...	10		
Selecting decoding page language in Teletext ...	10		
Digital Teletext language .....	10		
SPDIF type .....	10		
T-Link .....	11		
Enabling or disabling T-Link .....	11		
Using one-touch play .....	11		
Using system standby .....	11		
Common interface .....	11		
Using the common interface module .....	11		
Accessing common interface services .....	11		
Software update .....	11		
Changing to Shop or Home mode .....	11		
MHEG function .....	12		
Viewing photos, playing music and watching			
videos from a USB storage device .....	12		
Photo .....	12		
Music .....	12		

**Connecting the power and antenna**

To switch on TV after connecting power cord, press  $\text{⏻}$  or **POWER/⏻**.

*Note: Position of power socket varies according to TV model. On certain models, you have to turn on the power switch first.*

*Note: Disconnect the power cord before connecting devices.*

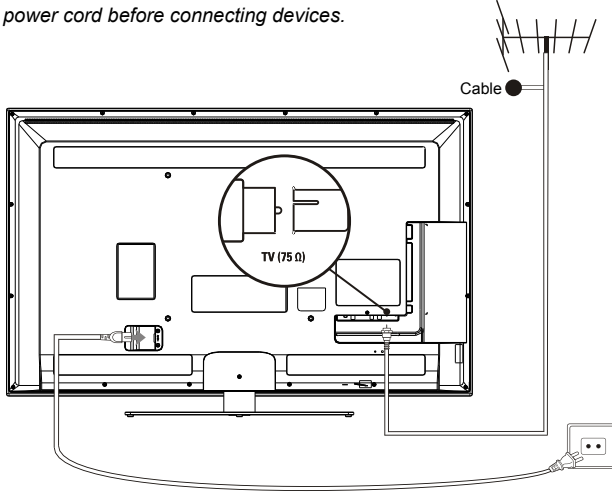

**DVD recorder, cable receiver**

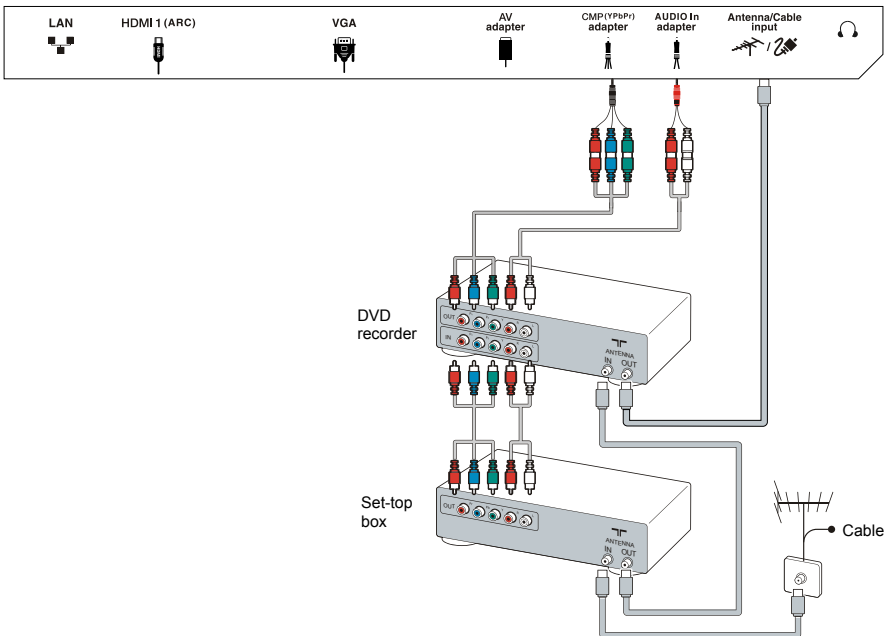

**DVD player, home theatre system, PC, headphones**

**Notes:**

- Before connecting a PC, set the PC monitor refresh rate to 60Hz.
- The connectors of VGA and CMP (YPbPr) share the same audio input connector.
- Excessive sound pressure from earphones and headphones can cause hearing loss.
- It is recommended to use as short as possible high quality HDMI cables to avoid possible interferences.
- It is recommended to use 1m long or shorter VGA cable with ferrite beads in case VGA input is available in TV and TV is connected using VGA cable. Maximum supported VGA resolution is 1024x768/60Hz.

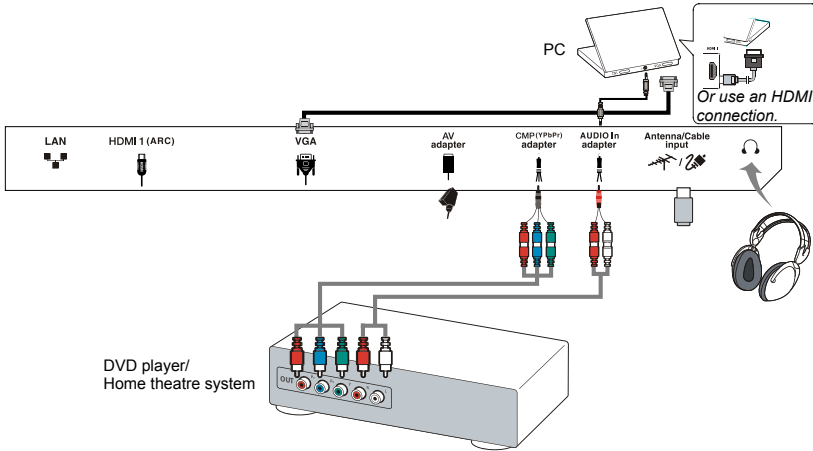

**Blu-ray Disc player, HD game console & HD camcorder**

**Notes:**

- ARC (Audio Return Channel) function is only supported on HDMI 1 (ARC) port.
- Number of HDMI ports may vary.
- USB connector is for data input from USB storage devices.
- All USB devices have to be directly connected to TV set without cable extenders. In case extender is required it has to be as short as possible and equipped with ferrite beads.
- MHL (Mobile High-Definition Link) function allows you to link an MHL-capable mobile device to the television and is only supported on the TV HDMI port identified with MHL.

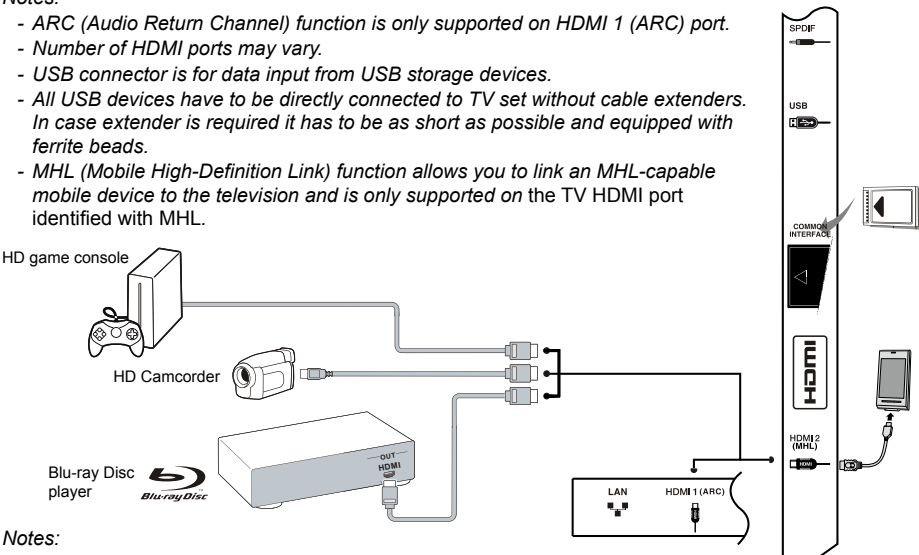

**Notes:**

- Not all connections available on all models.
- The location of the power socket on the TV may vary according to TV model.
- The positions and names of the function buttons and connectors on the TV may vary according to TV model.

## Remote control functions

Most of your television's functions are available via the menus that appear on the screen. The remote control supplied with your set can be used to navigate through the menus and to configure all the general settings.



- Source** To select connected devices.
- ⏻** Standby/quit standby.
- 0-9** To select a channel, page or setting.
- ECO** To select desired power saving mode.
- Guide** To toggle the Electronic Programme Guide on or off (only available for digital channels).
- Menu** To access the main menu; to return to the previous menu.
- Exit** To exit the menu structure or Teletext.
- ▲ ▼** To navigate in the main menu; to select menu options; to switch to the previous or next photo, song or video in USB function.
- ◀ ▶** To navigate in the main menu; to set functions and change values. **▶** can also be used to open the corresponding submenu.
- /\*Zoom+/-** \* To select the picture format.
- Note: You are recommended to use the full screen mode. Do not use the display mode with black bars on both sides of the picture (such as 4:3) for a long time, otherwise the TV screen may be damaged permanently.*
- OK** To open the corresponding submenu and activate a setting in menus; to freeze/unfreeze the picture in digital TV mode.
- Option** To display the function menu to perform certain operations; to display the Teletext page in different modes.
- Return** To return to the previous channel; to return to the previous menu in USB function.
- V+/-** To control the volume.
- Info** To display programme information, if available.
- Mute** To switch the sound off and back on.
- P+/-** To change channels.
- TEXT** To toggle Teletext on or off.
- SUBTITLE** To select a subtitle language available for selected digital TV programme.
- LIST** To display channel list.
- TV** To access TV mode.
- Colour buttons** To select tasks or Teletext pages. The red button can also be used for MHEG function.
- Ⓞ Lang** To select a sound type available for selected analogue TV programme; to select an audio language available for selected digital TV programme.

**Important:**



Batteries shall not be exposed to excessive heat such as sunshine, fire or the like. Remove batteries when the remote control is not to be used for a long time. Batteries left in equipment may cause damage through deterioration and corrosive leakage, invalidating the guarantee.

To protect the environment use local recycling facilities for battery disposal. Dispose of used batteries according to the instructions.

**CAUTION:** Risk of explosion if batteries are replaced by an incorrect type. Replace only with the same or equivalent type recommended by the equipment manufacturer.

If the batteries in your remote control are run down, you can use the buttons on the TV set. In TV mode, they have the same functions as the corresponding buttons on the remote control. The OK button on the TV set can be pressed repeatedly to select the required source. In the menus they have the following functions:







For models with **OK** button on the set:

<b>PR+</b> or <b>PR ▲</b>	▲
<b>PR-</b> or <b>PR ▼</b>	▼
<b>VOL+</b> ,  + or <b>VOL ►</b>	►
<b>VOL-</b> ,  - or <b>VOL ◀</b>	◀
<b>MENU</b> or 	Menu
<b>OK</b>	<b>OK</b>

For models without **OK** button on the set:

<b>PR+</b> or <b>PR ▲</b>	►
<b>PR-</b> or <b>PR ▼</b>	◀ & <b>OK</b>
<b>VOL+</b> ,  + or <b>VOL ►</b>	▲
<b>VOL-</b> ,  - or <b>VOL ◀</b>	▼
<b>MENU</b> or 	Menu

**Switching the TV on and off**

1. When the power cord is connected, the TV will be turned on directly or be in standby mode. If the TV is in standby mode, press the  or **POWER**/ button on the set or the  button on the remote control to turn it on.
2. To put the TV into standby mode, press the  or **POWER**/ button on the set or the  button on the remote control. The TV set remains powered up, but with low energy consumption.
3. To switch off the TV, unplug the mains plug from the mains outlet.

(\*On certain models, you have to turn on the power switch first.)

### Initial setup

Initial setup involves selecting all the settings required to be able to search for and store all the analogue and digital channels you can receive.





Make sure that the television is switched on and follow all the steps in turn specified hereafter.

*Note: If the channel search retrieved only the analogue channels it could be caused by poor broadcasting and therefore is not covered by manufacturer warranty. Manufacturers cannot be held responsible for lack of or poor broadcasting in some areas.*

The first time you switch the set on, the **Initial setup** wizard opens, which guides you through the initial setup process. (Refer to Figure 1.)

1. Press **▲/▼** to select your language, then press **OK/▶** to enter the next step.
2. Press **▲/▼** to select your country, then press **OK/▶** to enter the next step.

*Note: If you select France, you will have to enter the Password setting menu here in order to set a password. Use the numeric buttons to enter a four-digit number for your password. (0000 is too simple to be set as your password.) Re-enter the same code to confirm the password. After that, you will enter the next step automatically. (In this step, you can only press ◀ to return to the previous step.)*

3. Press **▲/▼** to select your tuner mode  **Antenna** or  **Cable** or  **Satellite**. (*Note: ◁ Satellite option may not be available for certain models.*) Then follow a) or b) or c) below.
  - a) If you have selected  **Antenna**.
    - Press **OK/▶** to enter.
    - Press **▲/▼** to select **Digital & Analogue** or **Digital** or **Analogue**, then press **OK/▶**.
    - Press **▲/▼** to select **Scan**, then press **OK/▶** to start the automatic search for all DVB-T digital and/or analogue channels.
  - b) If you have selected  **Cable**.
    - Press **OK/▶** to enter.
    - Press **▲/▼** to select **Digital & Analogue** or **Digital** or **Analogue**.
    - If you select **Digital & Analogue**, press **OK/▶** to enter. Then:
      - Press **▲/▼** to select **Scan**, then press **OK/▶**.
      - Press **◀/▶** to select the scan mode if available (**Full** or **Advanced**).
      - If you select **Full**, press **OK** to start the automatic search for all DVB-C digital and/or analogue channels.
      - If you select **Advanced**, use the numeric buttons to adjust the values for frequency, symbol rate, network ID, and use **◀/▶** to

select the modulation mode; then press **OK** to start the search for all DVB-C digital and/or analogue channels.

- If you select **Digital**, press **OK/▶** to enter, then follow all the same steps as for **Digital & Analogue** above, to search for all DVB-C digital channels.
  - If you select **Analogue**, press **OK/▶** to enter, press **▲/▼** to select **Scan**, then press **OK/▶** to start the search for all analogue channels.
- c) If you have selected  **Satellite**.
- Press **OK/▶** to enter.
  - Press **▲/▼** to select one antenna type.
  - Press **OK/▶** to select one satellite, then press **OK** to enter the next step to configure proper information related to this satellite. Press **OK** to go back after finishing settings.
  - Press **▶** to start scanning.

*Note: To prevent the channel setup process from being interrupted, wait for the message indicating that the setup is complete.*

4. Before starting the scanning, you can also select **Skip scan** to skip the initial setup process. In this case, to search and store your channels you may do an automatic channel search by following the instructions in the next section **Performing an automatic channel search**.
5. During the setup, you can follow the hints available at the bottom of the screen to return to the previous step by pressing **◀**. Or press **Exit** to exit or interrupt the search halfway.
6. Once the automatic search ends, the set enters the next step automatically. Press **▲/▼** to select your location **Shop** or **Home**. Press **OK/▶** to confirm your selection and enter the last step.
7. - In this step, you can press **OK** to exit the initial setup. The channels are arranged in a preset order. If you wish to skip channels, modify the preset order or rename channels, select **Setup > Organiser** and press **OK/▶** to enter.
  - In this step, you can also press **◀** to return to the previous step.







### Performing an automatic channel search

This section describes how to search and store channels automatically. Instructions are for both analogue and digital channels. This may be done in any of the cases below :

- you have selected **Skip scan** in the Initial setup
  - you see "**Please scan channels!**" in TV mode
  - you want to update your channels.
1. Press **Menu** on the remote control and select **Setup > Language > Menu language**. Press **◀/▶** to select your desired menu language.
  2. Press **Menu** to return to **Setup**. Press **▲/▼** to select **Country**, then press **◀/▶** to select your country. The TV installs and arranges channels



according to your country. At this step, you will be requested to enter your password.

3. Press ▲/▼ to select **Tuner mode**, then press ◀/▶ to select  **Antenna** or  **Cable** or  **Satellite**. (Note:  **Satellite option may not be available for certain models.**) Then follow a) or b) or c) below.
  - a) If you have selected  **Antenna**.
    - Press ▲/▼ to select **Channel install**, and press **OK/▶** to enter.
    - Select **Automatic search** (Refer to Figure 2.), then press **OK/▶** to display **Automatic search**.
    - Press **OK** to skip the country selection and enter the next step. Or use ◀/▶ to reselect your country, then press **OK** to enter.
    - Select **Digital & Analogue** or **Digital** or **Analogue**, then press **OK/▶** to start the automatic search, which relates to all DVB-T digital and/or analogue channels.
  - b) If you have selected  **Cable**.
    - Press ▲/▼ to select **Channel install**, and press **OK/▶** to enter.
    - Select **Automatic search**, then press **OK/▶** to display **Automatic search**.
    - Press **OK** to skip the country selection and enter the next step. Or use ◀/▶ to reselect your country, then press **OK** to enter.
      - If you select **Digital & Analogue**, then press **OK/▶** to enter. Select your scan mode if available and configure proper cable information in the same way as in Initial setup. Press ▲/▼ to select **Scan** and press **OK/▶** to start your automatic search relating to all DVB-C digital and analogue channels.
      - If you select **Digital**, then follow the same process as above to start your automatic search relating to all DVB-C digital channels.
      - If you select **Analogue**, then press **OK/▶** to start your automatic search relating to all analogue channels.
  - c) If you have selected  **Satellite**.
    - Press ▲/▼ to select **Channel install**, and press **OK/▶** to enter.
    - Select **Automatic search**, then press **OK/▶** to enter. You can select a proper satellite or an operator.
    - Press **OK** to go to the next step. Before you start scanning, you can press **OK** to edit the parameters of the selected satellite. Then with your desired options of **Scan mode** and **Channels**, select **Scan** and press **OK/▶** to start scanning.
4. The search may take a few minutes. During the process, you can press **Menu** to abort halfway.
5. Once the automatic search ends, press **Menu** to return to the previous step or press **OK** to restart your channel search.

6. After the automatic search, channels are arranged in a preset order. If you wish to skip channels, modify the preset order or rename channels, select **Setup > Organiser** and press **OK/▶** to enter.

## Using your TV

### Accessing channels

**Using the numeric buttons:** press the corresponding numeric buttons to access the channels.

**Using the PR/+ or P/+ buttons:** scroll through the channels.

### Watching connected devices

There are three ways for you to select connected devices on your TV:

- you can press **Menu** on the remote control and select **Source**.
- you can use the **OK** button to enter, then press ▲/▼ and **OK** to select your wanted connected devices
- you can also repeatedly press **Source** on the remote control or **OK** on the TV set to toggle between TV and other input sources.

To resume TV viewing, you can press any numeric button.

*Note: Not all models have OK button on the set.*

### Volume

Volume control: use the **VOL/+** or **VOL** ◀/▶ buttons on the TV set or **V/+** buttons on the remote control to increase or decrease the volume.

Sound mute: press the **Mute** button to temporarily mute the sound. Press this button again or the **V+** button to restore it.

### Using TV menus

1. Press **Menu** to display the main menu. (Refer to Figure 3.)
2. Press ▲/▼/◀/▶ to select the desired item, then press **OK** to open the corresponding submenu.
3. In submenu, use ▲/▼ to select menu options, use ◀/▶ to set functions or change values. Use **OK** to activate a setting. Use **OK/▶** to open the corresponding submenu.
4. Press **Menu** to return to the previous menu.
5. Press **Exit** to close the menu.

*Note: Some options may not be available for certain signal sources.*

### Selecting menu language

You can choose your preferred menu language following the instructions below.

1. Press **Menu** to display the main menu.
2. Press ▲/▼/◀/▶ to select **Setup**, then press **OK** to enter.

3. Select **Language** and press **OK/▶** to enter.
4. Select **Menu language** and press **◀/▶** to select your desired language to display the menus.
5. Press **Exit** to close the menu.

## Using more of your TV

### Setting up your favourite channels

You can create a list of your favourite TV channels.

1. Press **LIST**.
2. Press the yellow button to enter **Channel list selection**. Press **▲/▼** to select the favourite list and press **OK** to enter.
3. Press the blue button to start editing your favourite list. Press **▲/▼** to scroll through the channel list and press **OK** to select or deselect it.
4. Repeat this procedure to set up other favourite channels.
5. Press **LIST/Exit** to exit.

### ECO settings

1. Press **Menu** on the remote control and select **Picture > ECO settings**, press **OK/▶** to enter **ECO settings**.
2. Press **◀/▶** to select desired power saving mode to achieve the desired power saving effect. The **Picture preset** option under **Picture** will now be set to **Personal** simultaneously.
3. Press **Exit** to close the menu.

**Shortcut operation:** Press **ECO** on the remote control to perform the same function mentioned above.

### Audio description

Audio description refers to an additional narration track for Blind and visually impaired viewers of visual media, including television programmes and movies.

The description narrator talks through the presentation describing what is happening on the screen during the natural pauses in the audio (and during dialogue if deemed necessary).

You can use this feature if the current broadcast contains audio description.

1. Press **Menu** on the remote control and select **Sound**.
2. Press **OK** to enter.
3. Use **▲/▼** to select **Audio Description**, press **OK/▶** to enter, use **◀/▶** to turn this function on or off. Volume level can be adjusted by using the **Audio Description** menu.

### Using subtitles

You can enable subtitles for each TV channel. Subtitles are broadcast via Teletext or DVB-T/DVB-C digital broadcasts. With digital broadcasts, you have the additional option of selecting a preferred subtitle language.

### Turning on/off subtitles

1. Press **Menu** on the remote control and select **Options > Subtitle**.
2. Press **OK/▶** to enter. (Refer to Figure 4.)
3. Select the **Subtitle** option, and press **◀/▶** to select **On/Off** to turn on/off subtitles.

### Enabling subtitle languages on digital TV channels

1. Press **Menu** on the remote control and select **Options > Subtitle > Digital subtitle language**.
2. Press **◀/▶** to select a subtitle language as your preferred language.
3. Press **▲/▼** to select **Digital subtitle language 2nd**.
4. Press **◀/▶** to select a secondary subtitle language.
5. Press **Exit** to close the menu.

**Shortcut operation:** Press **SUBTITLE** on the remote control to directly select a subtitle language available for the selected digital TV programme.

### Selecting a subtitle type on digital TV channels

1. Press **Menu** on the remote control and select **Options > Subtitle > Subtitle type**.
2. Press **◀/▶** to select a subtitle type. You can select **Hearing impaired** to display the hearing impaired subtitles with your selected language.

### Selecting decoding page language in Teletext

Press **Menu** on the remote control and select **Options > Decoding page language**. Select a proper type of language in which Teletext will display.

### Digital Teletext language

On digital TV channels, depending on the broadcaster, you may be able to enjoy a service with multiple initial Teletext pages in different languages. This function allows you to select an available language as primary language, which relates to different initial Teletext pages.

Press **Menu** on the remote control and select **Options > Digital teletext language**. Press **◀/▶** to select.

### SPDIF type

Connect the TV to an audio device through the **SPDIF** output. To select a proper sound type for your **SPDIF** output, press **Menu** on the remote control and select **Options > SPDIF type**.

- If you select **PCM**, the SPDIF output format is PCM, regardless of the programme's sound format.
- If you select **Dolby D**, the SPDIF output format is Dolby Digital when the programme's sound format is Dolby Digital or Dolby Digital Plus or HE-AAC
- PCM when the programme's sound format is MPEG.

- If you select **Off**, this turns off the audio output from the audio device connected to the SPDIF output.

*Note: The options you may choose depend on the programme you are watching. If you select **PCM** and the sound is ahead of the picture, you can select **SPDIF delay** from the **Options** menu and press ◀/▶ to adjust the delay time to synchronize the sound with the picture.*

## T-Link

Use this function to search for CEC devices connected to the HDMI sockets in your TV and enable one-touch play and one-touch standby between CEC devices.

### Enabling or disabling T-Link

1. Press **Menu** on the remote control, then select **Options > T-Link**.
2. Press ◀/▶ to select **On** or **Off**, if this function is turned on, **T-Link** option will be available in the **Quick access** menu which you can enter by pressing the **Option** button on the remote control.

### Using one-touch play

With one-touch play, pressing the play button on (for example) your DVD remote control starts playback on your DVD device and automatically switches your TV to the correct source, displaying DVD content.

### Using system standby

With system standby, pressing the ⏻ button on (for example) your TV remote control switches your TV and all connected HDMI devices to standby mode.

*Note: **Guide Menu** will be available in the sublist of **T-Link** option when **T-Link** function is turned on and **CEC** devices are connected. With this function, you can operate **CEC** devices with a virtual on-screen controller and the TV remote control.*

*Note: The **CEC** functions depend on the devices connected and it is possible that some devices may not interoperate correctly when connected to this TV. The user manual or the manufacturer of the problematic devices should be consulted for further information.*

## Common interface

Encrypted digital TV channels can be decoded with a common interface module and a card provided by a digital TV service operator.

The common interface module may enable several digital services, depending on the operator and services you choose (for example, pay TV). Contact your digital TV service operator for more information about services and terms.

### Using the common interface module

**WARNING: Switch off your TV before inserting a common interface module. Be sure to follow the instructions described below. Wrong insertion of a common interface module may damage both the module and your TV.**

1. Following the directions printed on the common interface module, gently insert the module into the common interface slot on the TV.
2. Push the module in as far as it will go.
3. Turn on the TV and wait for the common interface function to be activated. This may take several minutes.

*Note: Do not remove the common interface module from the slot. Removing the module will deactivate the digital services.*

### Accessing common interface services

After inserting and activating the common interface module, press **Menu** on the remote control and select **Options > Common interface**.

This menu option is only available if the common interface module is correctly inserted and activated. On-screen applications and content are provided by your digital TV service operator.

### Software update

Press **Menu** on the remote control and select **Options > Software update**. Press **OK/▶** to enter. (Refer to Figure 5.)

- **Current version:** Displays the current version of the software.
- **Product name:** Displays the product name of your set.
- **Serial number** (if available): Displays the serial number of your set.
- **OAD** (Over Air Download): Enables you to install the latest version of the software if available from the broadcast. Select **OAD** and press **OK/▶** to enter.
  - Use ◀/▶ to select **Yes** under **Auto download** to automatically download the latest software if available. After the software has been downloaded successfully, you will be prompted to decide if you want to install it right now. If yes, follow the on-screen instructions to complete your installation. You can also select to ignore the installation here.
  - Select **No** under **Auto download** to decline the automatic download.
  - Select **Manual OAD download** and press **OK/▶** if you wish to search manually for the latest software. Follow the on-screen instructions to complete. During the search, press **OK/Exit** if you wish to cancel or exit the process.

### Changing to Shop or Home mode

1. Press **Menu** on the remote control and select **Options > Location**.

2. Press ◀/▶ to select your location **Shop** or **Home**.
3. Press **Exit** to exit.

*Note: According to the regulation of European Commission 2009/125/EC, in Home mode, TV will be put into standby mode automatically if there is no operation in 4 hours. This feature can be deactivated in Options menu.*

### MHEG function

Some digital TV broadcasters offer dedicated digital text or interactive services (for example, BBC1). These services work like normal Teletext with the addition of number, colour and navigation buttons.

1. Press **Menu** on the remote control and select **Options > Subtitle > Subtitle**.
2. Press ◀/▶ to set **Subtitle** to **Off**.

*Note: For some models, MHEG and subtitles are mutually exclusive and cannot coexist on the same screen. If Subtitle is set to On, MHEG will not appear.*

3. Press the red button or **TEXT** on the remote control.
4. Press ▲/▼/◀/▶ to select or highlight items.
5. Press **OK** to confirm or activate.
6. Press one of the colour buttons to select an option.
7. Press **TEXT** or **Exit** to exit.

### Viewing photos, playing music and watching videos from a USB storage device

Your TV is fitted with a USB connector that enables you to view photos, listen to music or watch videos stored on a USB drive.

Supported file formats:

Photo	JPEG
Music	MP3
Video	AVI, MP4, MPG, MPEG, TS...

*Notes: Some USB keys and USB products like digital cameras or mobile phones are not fully compatible with USB 2.0 standard so they may not work with the TV multimedia player. Not all USB keys or devices are compatible with the USB function. Not all above formats are recognised. The encoding formats of your files will determine whether or not they can be used.*

When a USB drive is detected, the TV enters the **Media center** menu directly. To enter the **Media center** menu manually, press **Menu** on the remote control and select **Media**.

#### Photo

Use this function to display photos, if available.

1. Select **Media center > Photo**, then press **OK** to enter the main file content browser.

2. In the main file content browser, use ▲/▼/◀/▶ to select a photo or an inner file folder.
3. Select an inner file folder, press **OK** to enter a sub file content browser.
4. Use ▲/▼/◀/▶ to select a photo in either main or sub file content browser, press **Menu** to display the photo menu in folder mode.
  - **Sort:** Sort folders and photos by modification Date or Name.
  - **Edit:** Copy, paste or delete a selected photo.
  - **Parser:** You can select **Recursive** to display photos from all sub file folders.
5. Select a photo, press **OK** to watch, and a slide show begins from the selected photo. Press **OK** to pause the photo. Press **Menu** to display the photo menu in the browser mode. You can play, pause or rotate the photo, select different play modes and display effects, etc.
6. Press the related buttons on the remote control to perform the available functions shown on the function bar at the bottom of the TV screen. Press the **Info** button to show or remove the function bar.

#### Music

Use this function to play back music, if available.

1. Select **Media center > Music**, then press **OK** to enter the main file content browser.
2. Use ▲/▼/◀/▶ to select a song in either main or sub file content browser in the same way as in photo display function, press **Menu** to display the music menu in folder mode.
  - **Sort:** Sort folders and songs by Name, Genre, Artist or Album.
  - **Edit:** Copy, paste or delete a selected song.
  - **Parser:** You can select **Recursive** to display songs from all sub file folders.
3. Select a song, press **OK** to play, and automatic playback begins from the selected song. Press **Menu** to display the music menu in the browser mode. You can play or pause the song, select different play modes, etc.
  - **Show lyrics:** This option is available for the songs with lyrics. Select it and use ◀/▶ to turn on/off lyrics synchronized display.
  - **Audio only:** Select and press **OK** to listen to the music with the screen turned off. Any key press will turn the screen on.
4. Press the related buttons on the remote control to perform the available functions shown on the function bar at the bottom of the TV screen.

#### Video

Use this function to watch videos, if available.

1. Select **Media center > Video**, then press **OK** to enter the main file content browser.
2. Use ▲/▼/◀/▶ to select a video in either main or sub file content browser in the same way as in

photo display function, press **Menu** to display the video menu in folder mode.

- **Sort:** Sort folders and videos by Type, modification Date or Name.
  - **Edit:** Copy, paste or delete a selected video.
  - **Parser:** You can select **Recursive** to display videos from all sub file folders.
3. Select a video, press **OK** to watch, and automatic playback begins from the selected video. Press **Menu** to display the video menu in the browser mode. You can play or pause the video, select different play modes, screen modes and preset picture settings, etc.
  4. Press the related buttons on the remote control to perform the available functions shown on the function bar at the bottom of the TV screen. Press the **Info** button to show or remove the function bar.

### Time access

You can access the time from digital channels following the instructions below.

1. Press **Menu** on the remote control and select **Timer > Clock > Auto synchronization**.
2. Press **◀/▶** to select **On**.

### Diagnostics on digital TV channels

1. Press **Menu** on the remote control and select **Setup > Diagnostics**.
2. Press **OK/▶** to display some signal information on the current digital channel, such as signal strength, frequency, etc.

### Reset shop

Allows you to reset the TV to factory default settings.

1. Press **Menu** on the remote control and select **Setup**, then press **OK** to confirm.
2. Select **Reset shop** and press **OK/▶** to enter.
3. Use the numeric buttons to enter the password.
4. Press **◀/▶** to select **OK** and press **OK** to confirm.
5. The **Initial setup** menu appears. Follow the related instructions.

### Customising the input settings

You can configure your TV according to the equipment you connect to it.

1. Press **Menu** on the remote control and select **Setup > Input settings**.
2. Press **OK/▶** to enter **Input settings**.
3. Press **▲/▼** to select a connector your equipment is connected to.
4. Press **◀/▶** to select the type of apparatus attached to this connector.
5. Press **Menu** to return to the **Setup** menu.

After configuring, the selected source label will be displayed after the name of the related connector in the source list when selecting **Source** in the **Menu** or

pressing **Source** on the remote control or **OK** on the TV set.

*Note: Not all models have OK button on the set.*

### Using Electronic programme guide

EPG is an on-screen guide that displays scheduled TV programmes. You can navigate, select, view and record programmes.

1. Press **Guide** on the remote control, the **Now and Next EPG** menu will appear, which allows you to get information about the current or next programme playing on each channel. Navigate through the different programmes using the navigation buttons on the remote control.
2. Use the colour buttons to view the **8 Days EPG**.
  - **Prev day** (Red): List the previous day's EPG.
  - **Next day** (Green): List the next day's EPG.
  - **View detail** (Yellow): Display the description of this programme if available.
  - **Type filter** (Blue): Programme guide filter for digital TV programmes.
    - Press the blue button to display the programmes' type and subtype (if available) lists.
    - Navigate through the different types and subtypes using the navigation buttons on the remote control.
    - Select one or more types, which you want to highlight from the **Type** list, press **OK** to select (or deselect). A checkmark will appear to the left of the type when selected. When you select a type, all its subtypes will be selected accordingly.
    - Also, you can select some desired subtypes without selecting any type first.
    - Press the blue button to exit the type and subtype list.
    - After filtering, all your desired digital TV programmes will be highlighted.
    - **Add schedule** (Option): Press **Option** on the remote control to bring up the **Schedule list** menu. For details on scheduled recording, refer to the **Schedule list** section.
3. Press **Guide/Exit** to exit the EPG and switch to the selected channel.

### PVR (Personal Video Recorder)

Allows you to record non encrypted TV programmes. Before you use the function, connect a USB drive to the set first.

*Note: Feature is available only in selected products and, due to specific TV network limitations and country technical requirements, might not be available in product or place of installation. Feature might also be blocked by TV network due to copyright protection (HD content, recording protection). Please use Option on the remote control to check if feature is available in your product.*

1. Press **Option** on the remote control and select **Quick access > PVR**.
2. Press **OK/▶** to enter.
3. Press:
  - the red button to start recording, the record file is put into a folder named after the channel number under the PVR folder in **Media center > Video**;
  - **▲/▼/◀/▶** to adjust the recording duration.
  - the green button to stop recording manually; in normal operation, the recording will stop automatically when the recording duration has passed.
4. In recording, PVR mini pane will also show on the screen to indicate the recording progress.
5. To watch the recorded programme, exit PVR mode first and go to **Media center > Video**. Select the folder PVR, then select the related record file. Press **OK** to play. (It is the same if you record a digital radio programme).

**Notes:**

- *Feature available only for digital non encrypted channels. Even when CICAM (CI or CI+) is inserted, feature is not available on encrypted channels.*
- *Only supports USB drive of FAT32 format.*
- *Before you connect the USB drive to the set, make sure you have backed up the data in the drive to avoid the loss of your important data due to unforeseen malfunction.*
- *The bigger the USB drive free memory for the PVR function, the bigger the recording length.*
- *If you want to change channel or signal source during recording, store the recording data before changing the channel or source.*
- *The set cannot play files normally if the parameters of the file exceed the limitations of the system, the file format is not supported, the file is damaged, or the file cannot be decoded.*
- *Do not disconnect the USB drive when the system is reading a file or transmitting data, otherwise the system or the drive may be damaged.*

**Schedule list**

This function is used to perform scheduled recording.

1. Press **Option** on the remote control and select **Quick access > Schedule list**.
2. Press **OK/▶** to display the schedule list.
3. To add a schedule into your schedule list, press the red button first to display **Schedule list**. Then,
  - **Channel number**: use **◀/▶** to select the channel number.
  - **Start date**: use the numeric buttons to set the recording date.
  - **Start time**: set the start time of the recording.
  - **Stop time**: set the stop time of the recording.

**- Schedule type:**

- Set **Reminder** to be reminded that you can switch to the scheduled programme when the time you have set comes. When time is out and you do not execute any operation, the dialogue box will disappear and no further operation will be executed.
  - Set **Record** if you really want to start your scheduled recording when the time you have set comes. When time is out and you do not execute any operation, scheduled recording will start automatically.
  - **Repeat type**: set different repeat modes for the recording.
4. Press **▲/▼/◀/▶** to select **Add**, then press **OK** to add the schedule you set into your schedule list.
  5. Press the red button to repeat above procedures to add another schedule.
  6. If you wish to edit or delete a schedule, select it and press **OK** to enter.
  7. Press **Exit** to close the menu.

**MHL (Mobile High-Definition Link)**

(\* not available for some models)

You can use the following functions by connecting the TV HDMI port identified with MHL and the USB port of mobile phone or similar device with an MHL cable.

- Charge your mobile phones from the TV.
- Two-way remote operation between TV and mobile phone.
- Video/Audio output from your mobile phone.

**Notes:**

- *These functions may not be available depending on the connected equipment.*
- *If there is no more battery life left in the connected device, charging will not start.*
- *To operate the mobile phone with the TV remote, you need to turn on the T-Link function first, then press **Option** and select **Quick access > T-Link > Setup > Guide Menu**. Follow the virtual keypad to do operations.*

**Connecting MHL-compatible Device**

- Connect the MHL-compatible device to the HDMI port identified with MHL on the TV using an MHL cable (not supplied), charging will start automatically.
- When connecting an MHL-compatible device to the HDMI port identified with MHL on the TV, switch the TV source to HDMI 2 or HDMI.

*Note: Do not connect the MHL-compatible device to any ports other than HDMI port identified with MHL.*

**When using MHL**

- Interoperability with MHL devices from other

- manufacturers is not guaranteed.
- TCL does not provide any guarantee, therefore, against operational failure such as that described below when an MHL source is connected to the TV.
  - No picture or sound
  - Some of the functions do not work by remote operation from the TV
- If MHL does not work properly, also contact the manufacturer of the source device for advice on its use.
- Do not disconnect the power plug of the TV when the TV is active and the MHL device is connected.
- Do not disconnect the power plug of the TV when the TV is in standby mode and the MHL device is connected.

## Other information

### Password in Parental Control

- The default password is 1234. You can change it to a new one.
- The super password is 0423. If you forget your code, enter the super password to override any existing codes.

### Troubleshooting

Please check the following list before requesting service.

#### There is no picture or sound.

- Make sure the power cord is properly inserted in the power outlet.
- Make sure the source type is set correctly.
- Make sure the antenna is properly connected.
- Make sure the volume is not set to minimum or the sound is not set to mute.
- Make sure the headphones are not connected.
- The TV may be receiving a signal other than from TV broadcasting stations.

#### Picture is not clear.

- Make sure the antenna cable is properly connected.
- Consider whether your TV signal is being properly received.
- Poor picture quality can occur due to a VHS camera, camcorder, or other peripheral being connected at the same time. Switch off one of the other peripherals.
- The 'ghost' or double image may be caused by obstruction to the antenna due to high-rise buildings or hills. Using a highly directional antenna may improve the picture quality.
- The horizontal dotted lines shown on the pictures may be caused by electrical interference, e.g., hair dryer, nearby neon lights, etc. Turn off or remove these.

#### Picture is too dark, too light or tinted.

- Check the colour adjustment.

- Check the brightness setting.
- Check the sharpness function.
- The LCD panel's fluorescent lamp may have reached the end of its service life.

#### Remote control does not work.

- Check the batteries of the remote control.
- Make sure the remote sensor window on the TV front is not under strong fluorescent lighting.
- Try to clean the remote sensor window on the TV front with a soft cloth.

If the above suggestions do not solve your technical issue, please refer to the warranty card for service information.

### Television specifications

TV Broadcasting	PAL/SECAM BG/DK/I/LL'
Receiving channels	VHF/UHF/Cable
Tuner type	Frequency synthesized

### Operating Conditions

Temperature 5°C - 35°C (41°F - 95°F)  
Humidity 20 - 80% (non-condensing)

### Storage Conditions

Temperature -15°C - 45°C (5°F - 113°F)  
Humidity 10 - 90% (non-condensing)

### OSS Notice

This product uses software library from Freetype Project.

This product uses software library which is distributed under the zlib license.

This product uses UNICODE software programs which are distributed under IBM Open source license.

This product uses glibc software programs which are distributed under the GNU license.