

DENON

DHT-S514

Sound Bar and Wireless Subwoofer System

Contents

Introduction	2
Accessories	2
Sound Bar Controls	3
Sound Bar Rear Panel	3
Subwoofer Rear Panel	3
Locating DHT-S514 Components	4
Wall-Mounting	4
Connecting DHT-S514 to your television	5
Setting the HDMI Control Function	5
Disable Your Television's Speakers	5
HDMI Input (ARC) – First Choice	6
HDMI Input (without ARC) – Second Choice	6
Digital Optical Input – Third Choice	7
Digital Coaxial Input – Fourth Choice	7
Analog Input – Fifth Choice	8
Connecting DHT-S514 to your HDMI equipment	8
Power Connections	8
The DHT-S514 Remote Control	9
About DHT-S514's Automatic Power Modes (without the HDMI cable)	10
About the DHT-S514 Control Button LEDs	10
Adjusting the subwoofer level	10
Volume Change Indication	10
Listening Modes	11
Night Mode	11
Using Bluetooth®	12
Use Any Remote to Control your DHT-S514	12
Pairing the sound bar and subwoofer	12
Troubleshooting DHT-S514	13
Specifications	15
Trademark information	15

Owner's Manual

Introduction

Thank you for choosing Denon. Modern flat-panel televisions are wonders of digital video, but leave little room for serious sound reproduction. Denon's DHT-S514 home theater sound bar speaker system will envelop you in rich, room-filling sound. Simple to set up and easy to use, the DHT-S514 transforms any TV into a home entertainment system, delivering truly wide range response including deep bass from the wireless subwoofer and clear mids and detailed highs from the multi-driver high fidelity sound bar. Simply connect it to your television and enjoy powerful, dynamic audio from your favorite TV shows, movies, games and music. DHT-S514's inputs adapt to any television or system arrangement. The DHT-S514 also accepts wireless Bluetooth® streaming for convenient audio playback from mobile devices. An ingenious remote control learning solution lets you continue using your familiar television or cable/satellite remote.

We've worked hard to make DHT-S514 the best performing product of its kind—and just as diligently to ensure it is the simplest to set up and easiest to use.

You're about to hear just how much you've been missing, but first, please take a few moments to review this brief manual. You probably think it is not really necessary, but doing so will help you get the most from the DHT-S514.

*Please save your original shipping carton and packing materials.
If you need to move or ship the DHT-S514, this is by far the safest way to do so.*

Accessories

- 1) **Remote Control**—remote control with battery.
- 2) **Subwoofer Power Cable**—connect to subwoofer power input.
- 3) **HDMI Cable**—best choice for connecting ARC equipped HDMI televisions.
- 4) **Digital Optical Cable**—best choice for connecting digital audio sources to DHT-S514.
- 5) **3.5 mm Stereo Cable**—for connecting a source to the Analog Input.
- 6) **RCA to 3.5 mm Adaptor**—adapts a left/right RCA output to a stereo 3.5 mm output.
- 7) **Sound Bar Power Supply**—connect to sound bar power input. (Your power supply may look different, depending on where you live.) The AC adapter and the power cable are packaged separately.
- 8) **IR Blaster cable**—connect to sound bar IR Blaster Output.
- 9) **Sound Bar for foot (19 mm/31 mm Two sets of two)**
- 10) **Non-slip stickers for subwoofer (4 stickers on one sheet)**
- 11) **CD-ROM (Owner's Manual)**
- 12) **Quick Start Guide**
- 13) **Mounting Template**
- 14) **Safety Instructions**
- 15) **Notes on radio**

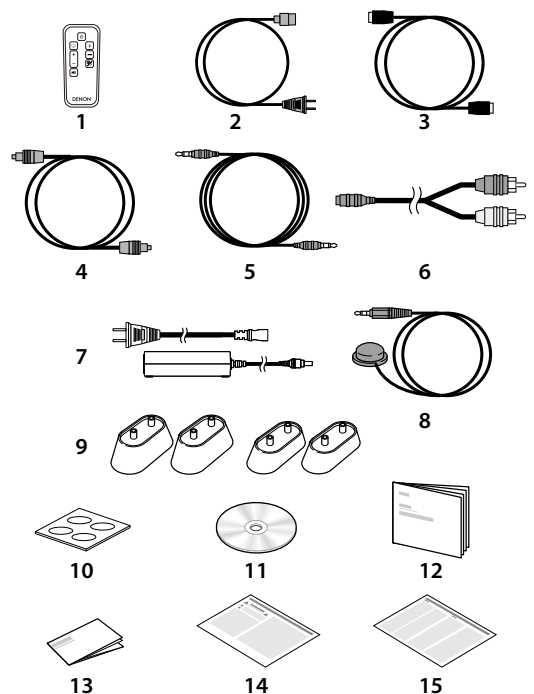

Sound Bar Controls

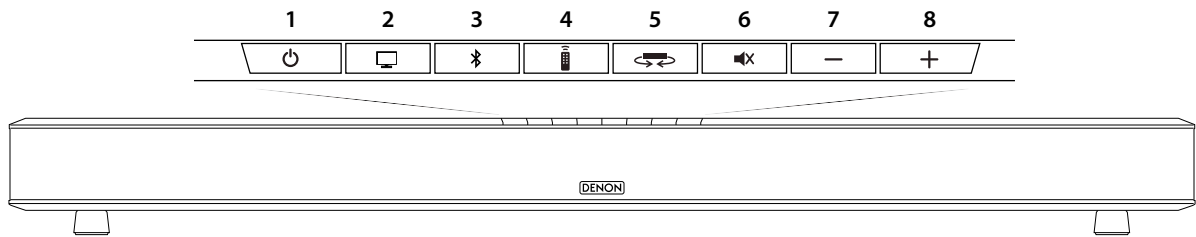

- 1) **Power on/standby**
- 2) **Television/HDMI Input**—select to watch television or connected HDMI equipment.
- 3) **Bluetooth wireless input**—select for Bluetooth pairing or playback.
- 4) **Remote Learning**—engages remote control learning.
- 5) **Listening Mode**—changes Listening Mode, stepping through the three modes in sequence.
- 6) **Mute sound**—Press to mute the audio, press again to unmute. (Pressing either Volume key also unmuters.)
- 7) **Volume down**—Decreases the volume. Press and hold to continually decrease the volume.
- 8) **Volume up**—Increases the volume. Press and hold to continually increase the volume.

Sound Bar Rear Panel

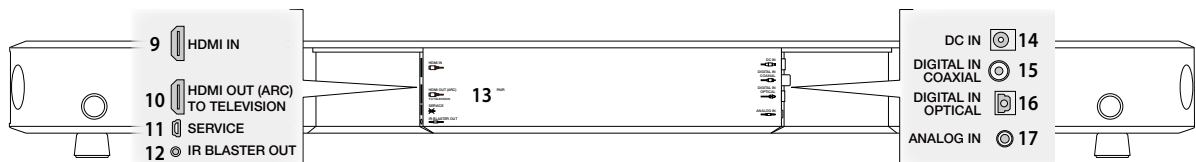

- 9) **HDMI Input**—connects to the HDMI equipment with an HDMI cable.
- 10) **HDMI Output (ARC)**—connects to the TV with an HDMI cable. Compatible with the ARC function.
- 11) **Service Port**—for service only, do not use.
- 12) **IR Blaster Output**—connect the supplied IR Blaster here. See “Locating DHT-S514 Components” (page 4) for more information.
- 13) **Pair Button**—Pre-paired at the factory. See “Pairing the sound bar and subwoofer” (page 12) for more information.
- 14) **Power Input**—connect the power supply cable here.
- 15) **Coaxial Digital In (RCA jack)**—connects to television’s coaxial digital audio.
- 16) **Optical Digital Input (S/PDIF)**—connects to television’s optical digital out.
- 17) **Analog In (3.5 mm mini plug stereo)**—connects to television’s rear panel audio out.

Subwoofer Rear Panel

- 18) **Power Input**—connect the supplied power cable here.
- 19) **Subwoofer Volume**—Adjusts the volume of the subwoofer for best balance with the sound bar.
- 20) **Pair Button**—Pre-paired at the factory. See “Pairing the sound bar and subwoofer” (page 12) for more information.
- 21) **Status LED**

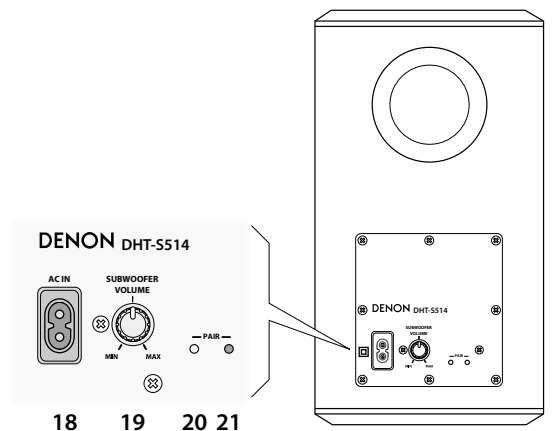

Locating DHT-S514 Components

The sound bar of the DHT-S514 should be placed as close as possible to the television screen. It should be centered left-to-right with the screen, and ideally no more than a few inches above or below. The most common location is below the screen. Sometimes this location can be difficult, because the base of the TV gets in the way. The DHT-S514 has two sets of feet – 19 mm and 31 mm high – that raise the sound bar off the shelf, for a more stable and attractive installation when used with this type of television.

Note: Depending on your TV model or installation location, the remote control receiver on the TV may be hidden by the sound bar, preventing the remote control from being used because the remote control signals cannot reach the TV. In this case, connect the supplied IR Blaster. Attach the tip of the IR Blaster near the TV remote control signal receiver and check that the remote control can be used to control the TV.

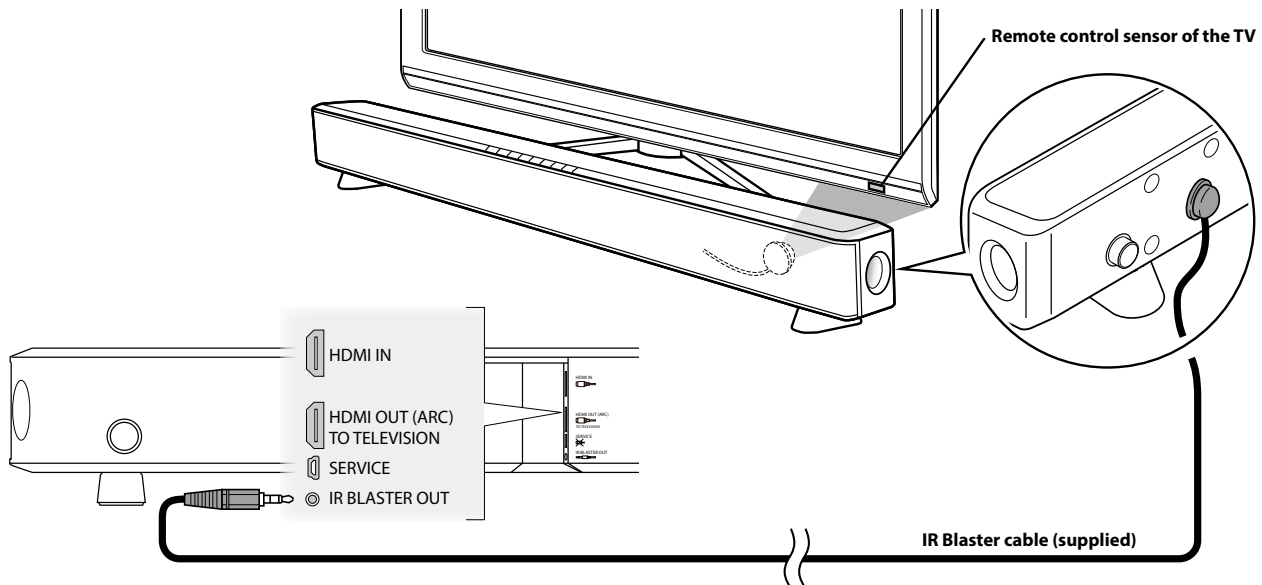
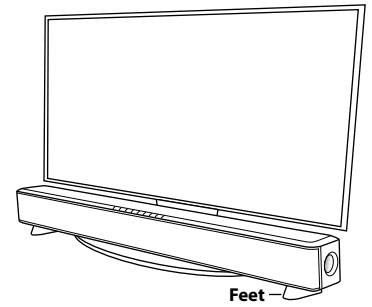

You may also place DHT-S514 sound bar on a shelf, or furniture, above or below the screen. It should be centered with the screen, and ideally no more than a few inches above or below. The system will usually sound best when the front of the sound bar is close to, or flush with, the front edge of the furniture or shelf on which it rests. This reduces unwanted sound reflections.

Place the wireless subwoofer anywhere in the room. For the best sound, place the subwoofer near a wall or corner, within 6 meters of the sound bar, and on the same side of the room as the sound bar. The wireless subwoofer range is 8 meters. Wireless subwoofer can be positioned vertically or horizontally. Attach the supplied non-slip stickers to the subwoofer.

Note: Don't put the subwoofer where curtains or furniture will block the sound. The port on the back of the subwoofer cabinet should be unobstructed.

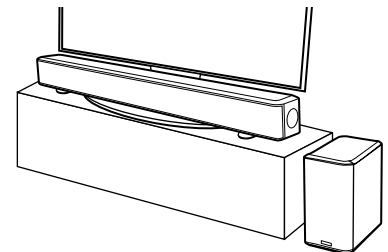

Wall-Mounting

The DHT-S514 sound bar can be wall-mounted using the integrated keyhole mounts. A mounting template can be found in the product carton. Using a level, position and tape the template to the wall in the desired location. Install hardware* using the template as a guide and then remove the mounting template from the wall. Connect the audio and power cables prior to mounting the sound bar on the wall.

*Consult a person knowledgeable about your wall type to recommend suitable hardware for hanging the speaker.



Note: To ensure safety, request a contractor perform the mounting work when mounting onto a wall.

In order to use the unit safely, do not place items on or hang items from the unit.

Be sure to fix connection cables to the wall to ensure that cannot be pulled or tripped over causing the unit to fall. Check that the unit is mounted safely after the mounting work is complete.

Also, periodically check the safety of the unit and whether there is a possibility that the unit may fall.

Denon cannot accept any responsibility for damage, injury or accidents caused by problems with the mounting location or mounting method.

Connecting DHT-S514 to your television

DHT-S514 can be connected to your system one of five ways. In order of preference they:

- ① **First Choice – HDMI Input (ARC)**—If your television has an ARC (audio return channel) HDMI connector, connect it to one of the HDMI Input of the DHT-S514. This will provide the best sound and several other benefits.
- ② **Second Choice – HDMI Input (without ARC)**—Connect to a TV that is not compatible with the ARC (audio return channel) function using the HDMI cable and audio input cable (③ – ⑤).
- ③ **Third Choice – Digital Optical Input (S/PDIF)**—A digital optical cable connection from the television also provides excellent sound.
- ④ **Fourth Choice – Digital Coaxial Input (RCA jack)**—Another way to supply a digital audio signal to the DHT-S514.
- ⑤ **Fifth Choice – Analog Input (3.5 mm stereo mini plug)**—You can enjoy the sound of the DHT-S514 with equipment that doesn't have digital signal outputs by connecting them to the analog input.

All five inputs are all selected by the television button on DHT-S514's front panel or remote, but which is active is determined by auto-priority. If only one input is receiving a signal, that input will play. If more than one input is receiving a signal, the order of priority is HDMI, Digital Optical, Digital Coaxial and Analog.

HDMI Connection

You can enjoy high quality audio and video playback by connecting this unit and a TV or this unit and a device such as a Blu-ray disc recorder or game console using a HDMI cable to transmit high resolution digital video signals and Blu-ray disc audio signals.

• ARC (Audio return channel) function

The TV audio can be played back through this unit using the HDMI cable used to connect this unit to the TV (*1).

*1: The TV also needs to be compatible with the ARC function.

• HDMI control function

You can switch off the power, switch input source and adjust the volume of this unit using the TV (*2) remote control.

*2: The TV also needs to be compatible with the HDMI control function. This function may not operate due to connected devices or settings.

Setting the HDMI Control Function

When the connection to the TV is the same as ① or ②, enable the HDMI control function on the TV.

If the TV is compatible with the ARC function, enable the ARC function on the TV.

(See the TV Owner's Manual for details.)

Disable Your Television's Speakers

When the connection to the TV is the same as ③ – ⑤, disable your television's built-in speakers when using DHT-S514. Usually, this is done with an on-screen setup menu on your television. Look for an "Audio" or "Sound" sub-menu, and a "Speakers Off", "Disable Speakers", "External Speakers" or similar menu item. Some televisions have a switch on the rear panel to disable the built-in speakers.



Don't leave the television speakers on so that both systems play simultaneously; this will not yield sound that is louder or "better."

HDMI Input (ARC) – First Choice

If your television has an ARC (audio return channel) HDMI connector, connect it to one of the HDMI output of the DHT-S514 with the supplied HDMI cable. Often, with televisions that have multiple HDMI connectors, the number one HDMI connector will be the one equipped with ARC.

Note: The TV also needs to be compatible with the ARC function.

Turn the TV HDMI control function on. See the TV Owner’s Manual for details.

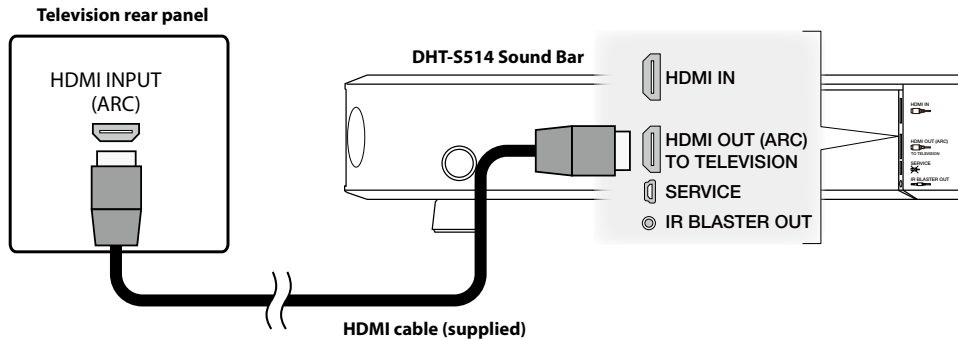

HDMI Input (without ARC) – Second Choice

When connecting to a TV that is not compatible with the ARC function, connect the TV to HDMI output on this unit using the supplied HDMI cable. You can also playback the TV audio on this unit by connecting the TV to audio input either digital optical cable (supplied), digital coaxial cable (not supplied) or 3.5 mm stereo cable (supplied).

Note: The TV audio cannot be played back on this unit when it is only connected with the HDMI cable.

[Example] When the audio output on the TV is a digital optical output:

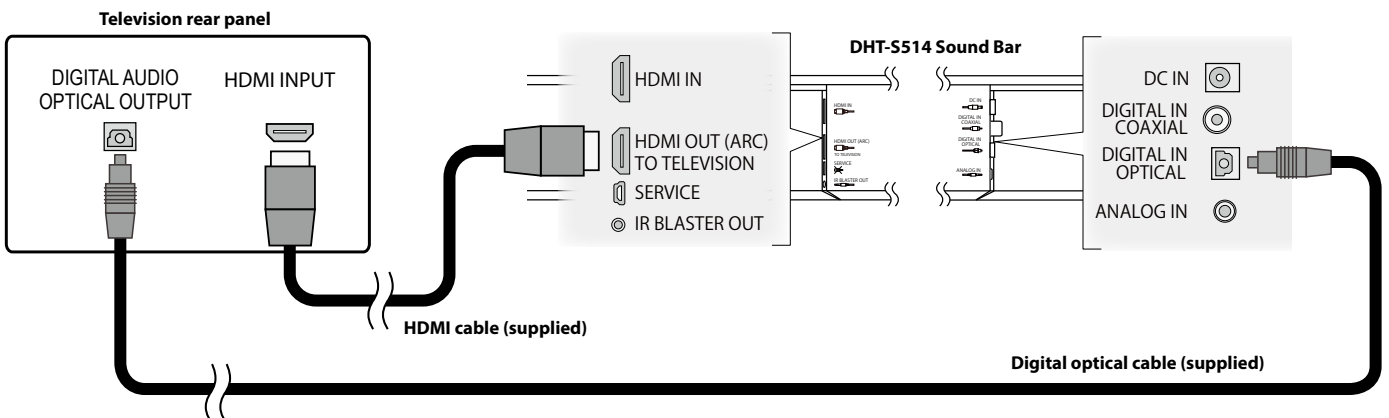

[Example] When the audio output on the TV is an analog output:

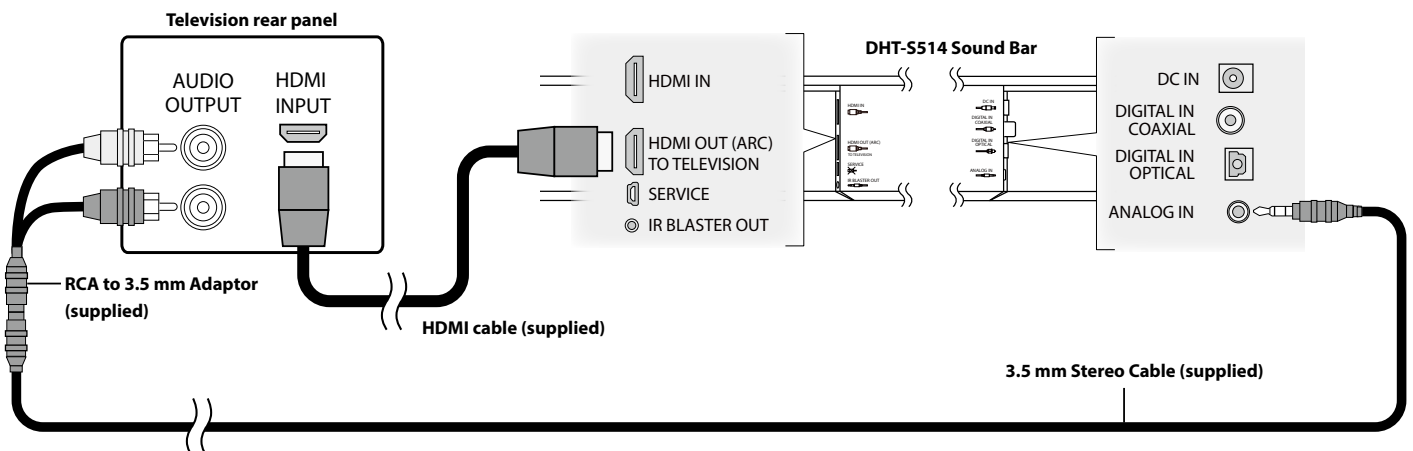

Digital Optical Input – Third Choice

Use the supplied digital optical cable to connect your television's optical digital output to DHT-S514's Optical Digital Input. Other components connected to the television, such as a DVD/Blu-ray player or cable/satellite tuner, will automatically play through DHT-S514.

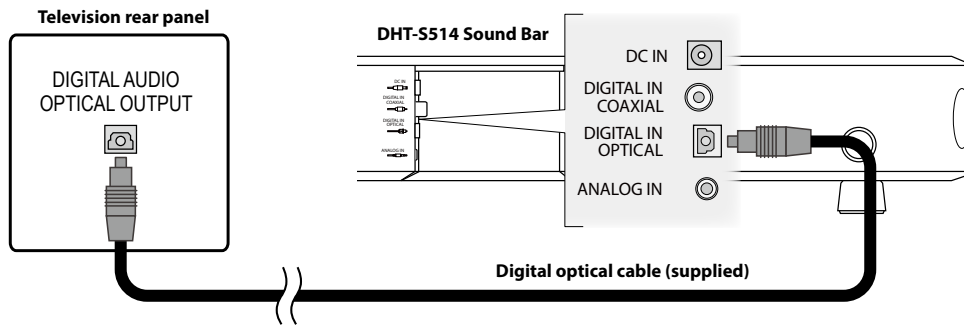

The optical connector looks square, but it is "keyed" and will only plug in one way; don't force it.

Digital Coaxial Input – Fourth Choice

If your television doesn't have an ARC equipped HDMI output or an optical digital output, it will probably have a coaxial digital output. Use an "RCA"-type cable (not supplied) to connect your television's coaxial digital audio output to DHT-S514's Coaxial Digital Input. Other components connected to the television, such as a DVD/Blu-ray player or cable/satellite tuner, will automatically play through DHT-S514.

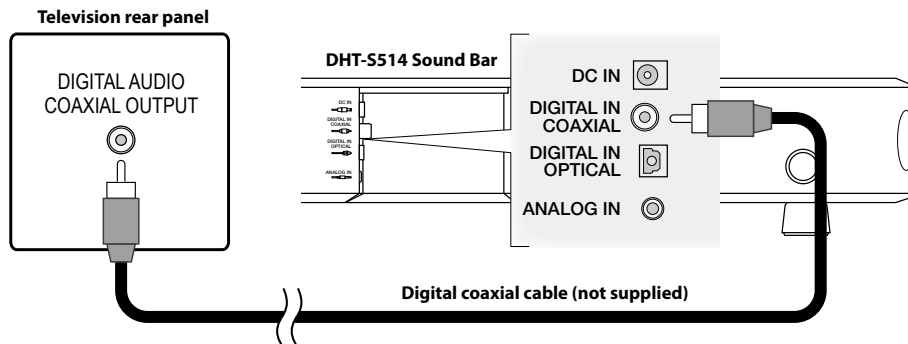

Analog Input – Fifth Choice

If your television has no digital audio outputs, connect its analog stereo audio output using the supplied 3.5 mm stereo cable to the analog input of the DHT-S514. The analog outputs of most televisions are dual RCA jacks (typically red for right and white or black for left). Use the supplied adaptor to connect those outputs to the 3.5 mm stereo cable.

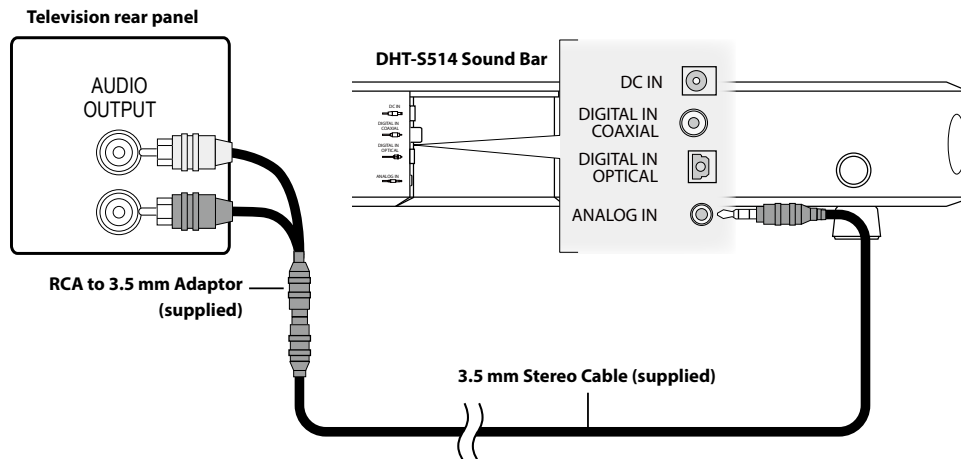

Connecting DHT-S514 to your HDMI equipment

You can play back from a device that has a HDMI terminal, such as a Blu-ray disc recorder or game console.

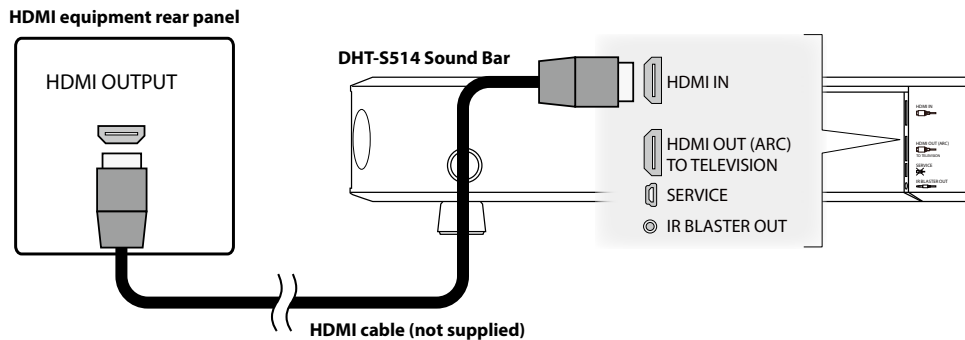

Power Connections

Connect the sound bar power supply and power cord to the sound bar power input. Connect the subwoofer power cord to the subwoofer power input. The wireless subwoofer connects to the sound bar automatically.

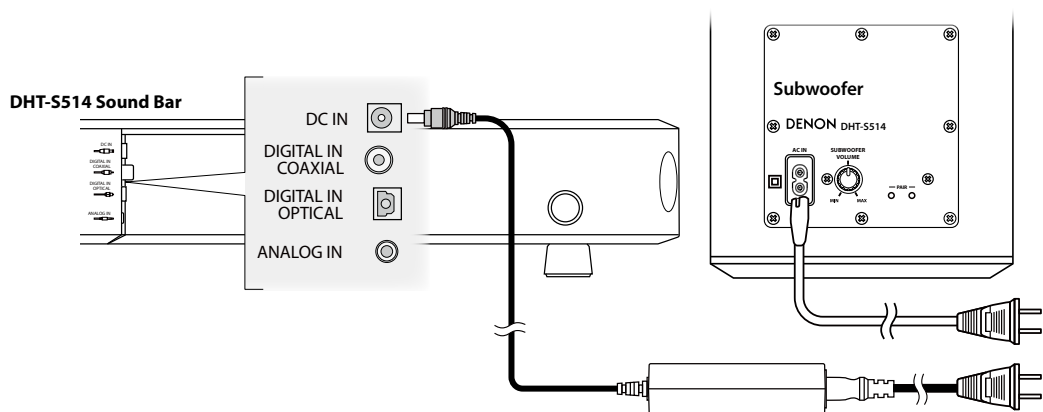

The subwoofer power switches on when the subwoofer power plug is inserted into the wall outlet. The PAIR LED on the back of the subwoofer flashes red.

Connection with the subwoofer starts when the sound bar power is turned on. The PAIR LED lights green when connection to the subwoofer has completed.

Note: If the LED does not light green, see page 12.

The DHT-S514 Remote Control

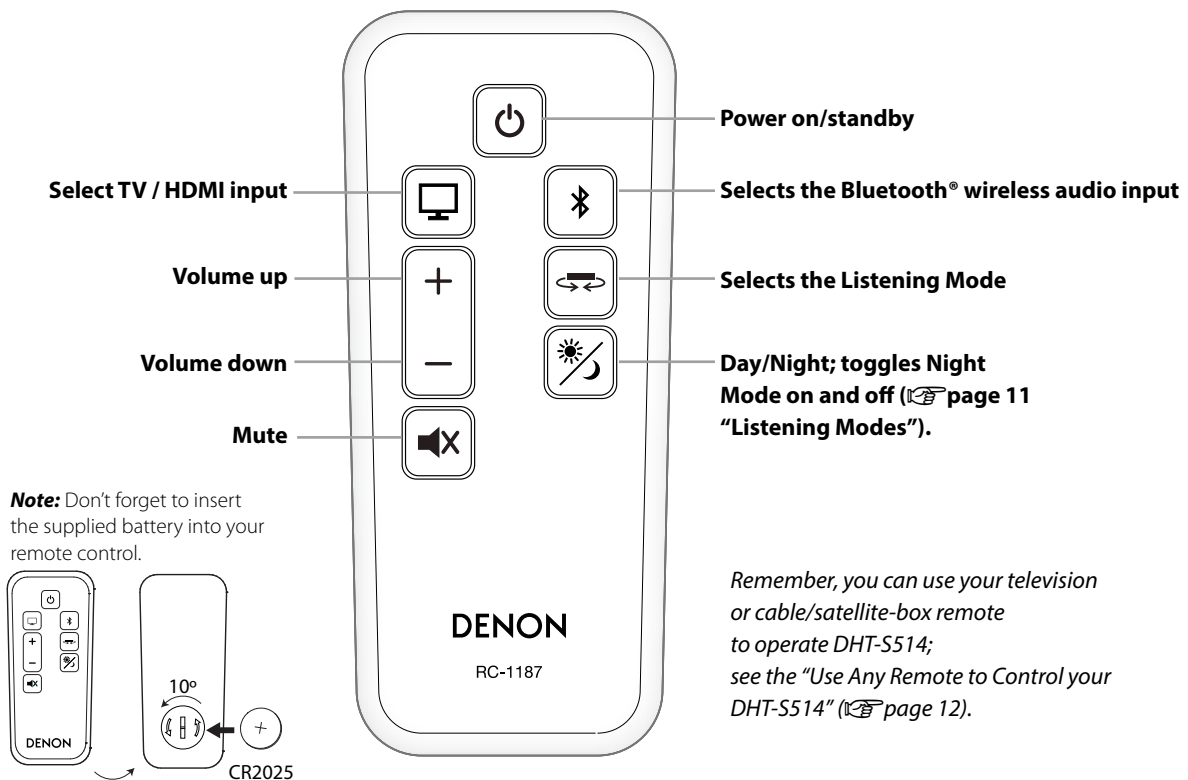

A remote control is supplied with DHT-S514. Its keys duplicate DHT-S514's front-panel buttons ("🔍" page 3 "Sound Bar Controls"), with one addition (Day/Night), and one deletion (the "Learn" key).





Note:

- Use lithium batteries in the remote control.
- Replace the batteries with new ones if the set does not operate even when the remote control unit is operated close to the unit. (The supplied batteries are only for verifying operation. Replace them with new batteries at an early date.)
- To prevent damage or leakage of battery fluid:
 - Do not short-circuit, disassemble, heat or dispose of batteries in flames.
 - Do not keep the battery in a place exposed to direct sunlight or in places with extremely high temperatures, such as near a heater.
 - If the battery fluid should leak, carefully wipe the fluid off the inside of the battery compartment and insert new batteries.
- Remove the batteries from the remote control unit if it will not be in use for long periods.
- Used batteries should be disposed of in accordance with the local regulations regarding battery disposal.

About DHT-S514's Automatic Power Modes (without the HDMI cable)

DHT-S514 will automatically “wake-up” whenever any of its wired inputs receives an audio signal. Simply turning on your television will also turn on DHT-S514. (For Bluetooth playback you will need to turn on DHT-S514 manually using the remote control or top panel power button). Because of DHT-S514's power saving design, the system takes five to seven seconds to turn on from standby. Pressing either the front-panel Television Input  or Bluetooth keys  will also power up the DHT-S514. Press the Power key  again to return DHT-S514 to its low-power “standby” mode. DHT-S514 will automatically return to standby after five minutes of not receiving an audio signal.

Note: Except the HDMI connection (For the HDMI connection, the HDMI control is activated ( page 5 “Setting the HDMI Control Function”).

If you wish to change this auto-on behavior you may switch between the standard automatic wake-up/standby mode, and a manual power on/standby mode. To change from one to the other, press-and-hold the front panel Power key  for three seconds. The power key LED will flash bright for three seconds, then illuminate steadily for three seconds, and then turn off, indicating you have changed to manual power mode. Each time you repeat the Power-key  press-and-hold, it will change to the other mode. In manual power mode the DHT-S514 is turned on, or standby, with a momentary press of the Power key .

About the DHT-S514 Control Button LEDs

The eight LEDs illuminating the top panel control buttons flash or light in various patterns to indicate different functions.



Power Momentarily bright when the DHT-S514 is turning on/waking from sleep; dimly lit while on/awake (operating mode); off when the DHT-S514 is “asleep” in standby mode; flashes when toggling between manual- and auto-on/standby modes.



TV/HDMI Input Switches the audio input of the DHT-S514. The input switches between TV Input and HDMI Input each time the button is pressed. The button LED flashes twice when the input is switched to TV input. The button LED flashes 4 times when the input is switched to HDMI input.



Bluetooth® Input Flashes bright, rapidly, while Bluetooth is “pairing” a wireless device; brightly lit when selected.
The Bluetooth LED will flash bright, slowly, while attempting to re-pair a device that has passed out of range or otherwise lost wireless contact, and blink rapidly to indicate a Bluetooth error (unable to pair). This will stop after 60 seconds or if any DHT-S514 key is pressed.

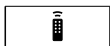

Learning Flashes when learning functions from your remote ( page 12 “Use Any Remote to Control your DHT-S514”).

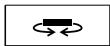

Listening Mode Flashes once when pressed at the front panel, and selects the next Listening Mode ( page 11 “Listening Modes”).



Mute Flashes bright continuously as long as Mute function is invoked.

Adjusting the subwoofer level

Use the Subwoofer Volume control on the rear of the subwoofer to adjust its sound output level. In many rooms, setting between 10 and 2 o'clock will sound good. Once set, you typically won't need to adjust this control.

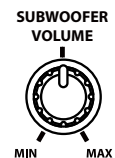

Volume Change Indication

When you adjust DHT-S514's volume from the remote control, the 8 front-panel LEDs momentarily function as a horizontal “bar-graph” of the volume setting reached, illuminating from 1 to all 8 buttons, the latter indicating maximum volume.

Listening Modes

DHT-S514 includes three Listening Modes for different kinds of audio programs, room acoustics, or personal preferences. It also has a special “Night Mode,” which enhances low-volume listening, which is described in the following section.

Select a Listening Mode using either Listening Mode key  (front panel or remote). Each keypress advances in sequence through the three modes – **Dialog**, **Music** and **Movie**. DHT-S514’s front panel key LEDs momentarily display a pattern representing each newly selected mode. The following information describes the various listening modes, and shows an illustration of the LED pattern displayed when that mode is selected.

Note: The LED displays used to indicate the various Listening Modes are simple horizontal display patterns—there is no correspondence between the lit LEDs and their underlying key functions.



Dialog mode highlights center-recorded sounds such as movie dialog, television announcers, or musical soloists; it is valuable for everyday television viewing.

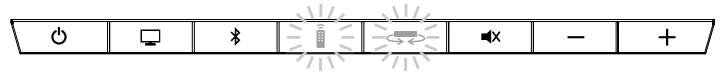

Music mode widens the “soundstage” somewhat for a more enveloping, involving sound.

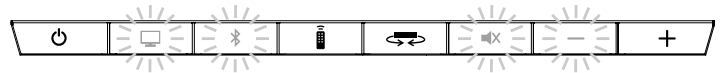

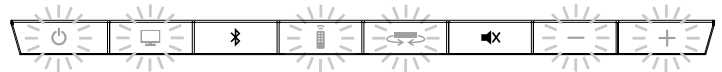

Movie mode deploys DHT-S514’s maximum processing for the “biggest” possible sound on action films or other large-scale content.



Night Mode

Night Mode improves low-volume listening by subtly lifting softer sounds, and lowering very loud ones. While you may use Night Mode whenever you like, for maximum dynamic realism from television programming, movies or music, leave night mode turned off.

To engage Night Mode, press the Day/Night button  on the remote control press, or press and hold the front panel Listening Mode button  for three seconds. When Night Mode is engaged, the LED pattern for the current Listening Mode dimly lights. To exit Night Mode, use the same buttons in the same way. When DHT-S514 exits Night Mode, the LED pattern for the current listening mode brightly lights.

Using Bluetooth®

DHT-S514 can stream music wirelessly, via Bluetooth, from any compatible Bluetooth device such as a mobile phone, tablet, or laptop computer.

Pairing Your Bluetooth Device

Before you can stream Bluetooth audio to DHT-S514, you must pair your device to DHT-S514.

To pair the device to the DHT-S514 for the first time:

- 1 Press-and-hold the Bluetooth key  (front panel or remote) for at least 3 seconds; the Bluetooth LED will begin to flash rapidly.
- 2 Go to Bluetooth settings on your device. Make sure the device's Bluetooth feature is set to "on".
- 3 From the Bluetooth list on your device, select "DHT-S514".
- 4 Playback audio on the Bluetooth source; you should now hear audio from the DHT-S514. DHT-S514's Bluetooth key LED will remain on as long as DHT-S514's Bluetooth input is selected and active.

DHT-S514 can pair multiple Bluetooth devices; however, only one can play at a time. First come, first served. One Bluetooth Source will need to be disconnected before another paired device can play.



Use Any Remote to Control your DHT-S514

It's easy to "teach" DHT-S514 to respond to nearly any conventional IR (infrared) remote, so that you may continue to use your favorite television or cable/satellite. You may prefer to teach DHT-S514 only selected commands, to avoid unintentional operations and subsequent confusion among some household members. Some DHT-S514 owners teach only Volume Up/Down and Mute, relying on the DHT-S514's front panel, or DHT-S514's own remote, for other functions.

Learning commands (using Volume up as an example):

- 1 Press-and-hold the front panel's Learn button  for 3 seconds; its key LED will flash slowly.
- 2 Now press the front-panel Volume up key; the Volume up key LED will also commence flashing slowly, in sync with the Learn LED.
- 3 Within 60 seconds, aim the "source" remote (for example, the television handset) from approximately 0.5m directly toward DHT-S514's front panel, and press its Volume up key 4 times in slow succession; both flashing DHT-S514 LEDs will now light steadily for 3 seconds, indicating a successful "learn."

Unlearning commands

- 1 Press-and-hold the front panel's Learn button  for 3 seconds; its LED will flash slowly.
- 2 Press the button you want to clear; the button's LED will also flash slowly, in sync with the Learn LED.
- 3 Press the learn button  within 60 seconds; both LEDs will flash rapidly for 3 seconds. The command has been unlearned.

Seven of the eight DHT-S514 front-panel buttons can be taught to respond to an external remote. Simply repeat this three-step process for as many of the other DHT-S514 commands (each associated with a front-panel button) as you wish.

Note: Rapid blinking of the two LEDs indicates a failed "learn". Press any other front-panel or DHT-S514 remote key to reset learning, and start again. See the Troubleshooting section ( page 13) for tips to help you successfully teach DHT-S514 to recognize the signals from your remote control.

Once you have programmed DHT-S514 to respond to your "everyday" remote controller, you may wish to put away the DHT-S514 remote for safekeeping. If you do, we recommend that you remove the battery, and wrap it in a slip of paper, masking-tape, or similar to prevent accidental discharge and put it and the DHT-S514 remote someplace safe.

Some remotes can learn by pressing the remote key several times (up to four times).

Pairing the sound bar and subwoofer

The subwoofer and sound bar are paired at the factory. However if the communication is interrupted, follow this procedure.

- 1 Press the Pair Button on the subwoofer until the Status LED flashes red rapidly.
- 2 The sound bar power is turned on.
Press the Pair Button on the back of the sound bar. The Status LED on the subwoofer will be solid green.

Status LED

Red LED: Subwoofer not paired to, or searching for sound bar.



Green LED: Subwoofer is paired to sound bar. Your system is ready.

Troubleshooting DHT-S514

DHT-S514 Does not power on

- Is the DHT-S514 plugged into a proven-live wall outlet? Try a lamp or other known-good appliance. Avoid using outlets that are connected to switches or dimmers.

No sound

- Is DHT-S514's volume turned up? (Don't laugh; we do this one ourselves all the time.)
- Is DHT-S514 muted (if so, the front panel Mute key  LED will be flashing).
- Is the DHT-S514 set to the correct source? A flashing Bluetooth® key  LED on the front panel indicates DHT-S514 is trying to "pair" to Bluetooth; press the Television Input key  to interrupt this and switch to television sound.
- Is the audio source a volume-controlled television or cable/satellite box output? If so, you must turn up the volume of the television or cable/satellite box to send adequate signal-level to DHT-S514. (For this reason it is best to choose fixed-level outputs where possible; some televisions have separate physical outputs, other employ on-screen menu settings to manage this.)
- Check connections: remember that DHT-S514 auto-prioritizes multiple incoming signals, selecting HDMI, optical-digital, coaxial-digital, and analog-mini plug, in that order. Confirm that the television is routing audio to the appropriate output; there may be TV-menu settings to manage this.

No subwoofer sound, sound interrupted, or noise occurring

- Check that the Status LED is lit in green on the subwoofer. When the Status LED is flashing in red, disconnect from the wall outlet and then reconnect to it, or try to pair again ( page 12 "Pairing the sound bar and subwoofer").
- When there is an obstacle between the sound bar and the subwoofer, remove it or place the subwoofer closer to the sound bar.

Distorted sound from the DHT-S514

- If the signal source is a volume-controlled output, turn it down a couple of steps from maximum.
- Check the signal source to be sure the distortion is not originating there.
- If DHT-S514's volume is set to its maximum, turn it down a few steps.

Trouble teaching DHT-S514 remote control commands

- Make sure the source remote is working properly in the first place; check batteries; confirm direct operation.
- Move the DHT-S514 and source remote out of bright sunlight or powerful room lighting (too-bright light will impede infrared-signal transmission).
- Be sure to hold the "source" remote steady, 0.3 – 0.5 m in front of the DHT-S514, on its level, with the remote's IR emitter (usually a smooth black-plastic area across the end you point toward the television) aimed straight and level at the center of DHT-S514's front panel.
- Press and release source-remote keys deliberately; hold each keypress down for a half-second or so, and pause a second between repetitions.
- Remember that while DHT-S514 can learn almost all IR (infrared) remote commands, there remain a few rare code formats that cannot be taught (much like some engineers we know).

Television speakers keep getting turned back up

- Disable the television's speakers (usually a setup-menu option, but a rear-panel switch on some televisions). If this is not possible, the problem is likely that the television responds to press-and-hold (ramping) volume commands more quickly than the DHT-S514; in this rare case use DHT-S514's front-panel or supplied remote to turn the DHT-S514's volume up.

Trouble Pairing Bluetooth®

- Make sure DHT-S514 is in Bluetooth pairing mode (Bluetooth key LED should be flashing).
- Make sure your Bluetooth source is in Bluetooth pairing mode (see the source's instructions).
- Bluetooth source device must support A2DP (Advanced Audio Distribution Profile); some Bluetooth products (some tablets, some GPS units, for example) will thus work with Bluetooth keyboards or headsets but are not capable of high-fidelity audio playback.
- Keep your Bluetooth source within 3m of DHT-S514 while pairing.
- Power cycle the Bluetooth device (complete power off and "hard-reboot"), and try to pair again.

Bluetooth connection problems

- If a Bluetooth fault occurs (the device moves out of range, or stops playing due to low battery or user input), DHT-S514's Bluetooth LED again blinks rapidly; the DHT-S514 will automatically attempt to re-connect, and will resume playback when the Bluetooth source is in range. Note: On some devices you will need to press play again. Bluetooth's effective wireless range varies with the source; (9 – 12 m) is typical. If the source moves out of range, DHT-S514 will continue trying to re-connect it for 4 minutes; after that interval you will have to re-connect, as above.
- Make sure DHT-S514 is not paired to a different Bluetooth source device.
- Make sure your desired Bluetooth source device is actually playing music or another audio program and is paired to DHT-S514 and not some other device.
- On a multifunction source device such as a tablet or mobile phone, not every program or "app" may support Bluetooth audio broadcast (consult the instructions for the program or app).
- Consider possible sources of interference, particularly those operating at 2.4 GHz (Wi-Fi routers, microwave ovens, landline cordless telephones); power down suspects one at a time to identify a culprit. Often, repositioning an interfering device to another room, or even across the room, will restore Bluetooth function.

DHT-S514 takes several seconds to turn on

- The DHT-S514's power saving design puts the unit into standby mode after five minutes of no sound. DHT-S514 takes a few seconds to start up the next time audio plays.

Factory reset

- Unplug sound bar from wall.
- Hold down Vol – (minus) button.
- Plug into power again.
- Standby button light will blink fast for several seconds indicating that the system has been reset.
- Clears Bluetooth pairing, remote learning, audio mode.

Specifications

Rated output:	
Sound bar	10 W + 10 W (4 Ω/ohms, 200 Hz, 0.7 % T.H.D)
Subwoofer	49 W (4 Ω/ohms, 60 Hz, 0.7% T.H.D)
Frequency Range:	40 Hz to 20 kHz
High Frequency Drivers:	35/64" (14 mm) tweeter x 2
Mid Frequency Drivers:	2 1/64 x 5" (51 x 127 mm) HHRT drivers x 2
Low Frequency Drivers:	5 15/64" (133 mm) woofers x 2
Dimensions: (H x W x D)	
Sound bar	3 9/64 x 39 17/32 x 3 5/64" (79.8 x 1004 x 78.3 mm)
Subwoofer	12 21/64 x 6 3/4 x 13 5/8" (313 x 171.5 x 346 mm)
Wireless Technologies:	Bluetooth 2.1 + EDR, A2DP, APT-X 2.4/5.2/5.8 GHz triband frequency hopping (subwoofer)
Rating Voltage:	AC 120V, 60 Hz
Power consumption:	
Sound bar	DC 24 V, 2.5 A 0.5 W or less (Standby)
Subwoofer	60 W
Weight:	
Sound bar	5 lbs 1 oz (2.3 kg)
Subwoofer	13 lbs (5.9 kg)

Specifications are subject to change without notice.

Trademark information



Manufactured under license from Dolby Laboratories. Dolby, Pro Logic, and the double-D symbol are trademarks of Dolby Laboratories.



The Bluetooth® word mark and logos are registered trademarks owned by Bluetooth SIG, Inc. and any use of such marks by D&M Holdings Inc. is under license. Other trademarks and trade names are those of their respective owners.



Manufactured under license under U.S. Patent Nos: 5,956,674; 5,974,380; 6,487,535 & other U.S. and worldwide patents issued & pending. DTS, the Symbol, & DTS and the Symbol together are registered trademarks & DTS Digital Surround and the DTS logos are trademarks of DTS, Inc. Product includes software. © DTS, Inc. All Rights Reserved.



©2013 CSR plc and its group companies.

The aptX® mark and the aptX logo are trade marks of CSR plc or one of its group companies and may be registered in one or more jurisdictions.



The terms HDMI and HDMI High-Definition Multimedia Interface, and the HDMI Logo are trademarks or registered trademarks of HDMI Licensing LLC in the United States and other countries.



Adobe, the Adobe logo and Reader are either registered trademarks or trademarks of Adobe Systems Incorporated in the United States and/or other countries.

DENON

www.denon.com

D&M Holdings Inc.
3520 10274 00AD