

TO : DEUBA BMBH & CO KG - MARGARITA WANG/KRAUS/ALINA LI/DANIEL BEHRENS/UDO SCHAFFER  
C.C. : INTERTEK CONSUMER GOODS GMBH - GREY BAXTER

NUMBER: SHIJ894611 (1<sup>ST</sup> REVISED)

THIS IS TO SUPERSEDE REPORT SHIJ894611 DATED SEP 10, 2020

INSPECTION REPORT

APPLICANT: DEUBA BMBH & CO KG  
ZUMA WIESENHOF 84  
66663MERZIG  
GERMANY  
ATTN.: UDO SCHAFFER

DATE: Sep 10,2020



PRODUCT (ASSEMBLED)



UNIT PACKING

DESCRIPTION : *big play kitchen/small play kitchen*  
BUYER : *DEUBA BMBH & CO KG*  
SUPPLIER : *DEUBA BMBH & CO KG*  
FACTORY NAME : *ZHEJIANG TAISHUN ZHENXING TOYS CO.,LTD.*  
FACTORY ADDRESS : *JIAOYANG INDUSTRIAL PARK, TAISHUN COUNTY, WENZHOU CITY, ZHEJIANG PROVINCE*  
ORDER NO. : *DB8430001/DB8430002*  
MODEL NO./STYLE NO. : *108639/108640*  
SUPPLIER ART. NO. : *TZ-D6010/TZ-D6011BA*  
COLOR : *--*

DATE OF INSPECTION : *Sep 08,2020* to *Sep 09,2020*  
PLACE OF INSPECTION : *CHINA(TAISHUN,WENHOU,ZHEJIANG)*  
FULL NAME OF INSPECTOR(S) : *Jacey Chen*

CONCLUSION:

[ X ] Combine items sampling inspection

"Per the Client's request, Intertek has performed this inspection by using the combine items sampling method. The Client understands that under this inspection method the statistical techniques that would otherwise be the most appropriate for this particular inspection as under the applicable single item sampling method will be substantially compromised, hence the chance of failing to identify quality and other problems in the inspected goods is greater than that when using the single item sampling method. In view of that, the Client and Intertek hereby expressly agree that Intertek shall be exempted from all and any liability caused by or arising from using the combine items sampling method including liabilities to any party for any decision or reliance concerning the acceptance, payment authorization or shipment of the inspected goods and the Client will hold Intertek harmless against any loss and damages as a result of so doing."



TO : DEUBA BMBH & CO KG - MARGARITA WANG/KRAUS/ALINA LI/DANIEL BEHRENS/UDO SCHAFFER  
C.C. : INTERTEK CONSUMER GOODS GMBH - GREY BAXTER

NUMBER: SHIJ894611 (1<sup>ST</sup> REVISED)  
THIS IS TO SUPERSEDE REPORT SHIJ894611 DATED SEP 10, 2020

**The inspection results of the above mentioned merchandise were found as follows:**

<u>INSPECTION CRITERIA</u>	<u>* RESULT</u>
A) QUANTITY AVAILABLE	CONFORMED
B) PRODUCT DESCRIPTION, STYLE AND COLOUR	NOT CONFORMED, REFER TO SPECIAL ATTENTION POINT 1
C) WORKMANSHIP	CONFORMED
D) DATA MEASUREMENT/CHECKING	NOT CONFORMED, REFER TO SPECIAL ATTENTION POINT 2,3,4
E) PACKAGING	NOT CONFORMED, REFER TO SPECIAL ATTENTION POINT 5,6,7
F) SHIPPING MARK	CONFORMED

SUMMARY RESULT	CRITICAL	MAJOR	MINOR
WORKMANSHIP	0	5	7
NUMBER OF DEFECT ALLOWED:			
TOTAL:	0	0	5

OVERALL INSPECTION RESULT : **NOT CONFORMED** to applicant's requirement.

Please advise your comment on the inspection findings.

\*\*\*\*\*



TO :DEUBA BMBH & CO KG - MARGARITA WANG/KRAUS/ALINA LI/DANIEL BEHRENS/UDO SCHAFFER  
C.C. :INTERTEK CONSUMER GOODS GMBH - GREY BAXTER

NUMBER: SHIJ894611 (1<sup>ST</sup> REVISED)  
THIS IS TO SUPERSEDE REPORT SHIJ894611 DATED SEP 10, 2020

**SPECIAL ATTENTION**

1. Product description, style and colour check
  - A.For item#108639,the shape of board "15"was found different with that printed on instruction manual.
  - B.For item#108639,the shape of screw "R","W"were found different with that printed on instruction manual;
  - For item#108640,the shape of screw"W"was found different with that printed on instruction manual.
2. Master carton gross weight for item#108640(out of tolerance +/-5%)
  - printed on master carton and specification:6.1kg
  - actual finding:6.8kg,6.8kg
3. Product size check for item#108640(out of tolerance +/-5%)
 

	Required	Actual finding
Plastic feet	Will rise 6cm	Will rise 6.8cm for all 5 samples
Two hating plate	diameter 7.5cm	diameter 9.8cm for all 5 samples
Screw "C"	4x16mm	4x19mm for all 5 samples
4. Barcode scanning check on service card and instruction manual for all items
  - after QR code scanning,the information could not be showed completely on mobile phone.
5. Packing deviation for item#108639
  - required:plastic parts and light should be packing together.
  - actual finding:the plastic parts and light were not packed together.the plastic parts were packed into two poly-bags, however,the light was packed into a white box then packed into a inner carton.
6. For item#108639,the rating label was found printed on a white paper,however,it was required printed on a silver film paper.
7. Age warning symbol deviation for all items
  - A.-required:the circle and the stroke was red
  - actual finding:the color of age warning symbol printed on master carton and labels was black
  - B.-required:diameter at least 10mm
  - actual finding:8mm for sticker for all items;6 mm for rating label for item#108639

\*\*\*\*\*



TO : DEUBA BMBH & CO KG - MARGARITA WANG/KRAUS/ALINA LI/DANIEL BEHRENS/UDO SCHAFFER  
C.C. : INTERTEK CONSUMER GOODS GMBH - GREY BAXTER

NUMBER: SHIJ894611 (1<sup>ST</sup> REVISED)  
THIS IS TO SUPERSEDE REPORT SHIJ894611 DATED SEP 10, 2020

INSPECTION REQUIREMENT : FINAL RANDOM INSPECTION  
INSPECTION STANDARD ADOPTED: ANSI/ASQC Z1.4  
SINGLE SAMPLING PLAN FOR NORMAL INSPECTION GENERAL INSPECTION LEVEL II  
ACCEPTABLE QUALITY LEVEL (AQL) FOR:  
CRITICAL NONCONFORMITY (DEFECTIVE) : Not Allowed  
MAJOR NONCONFORMITY (DEFECTIVE) : 1.5  
MINOR NONCONFORMITY (DEFECTIVE) : 2.5

**INSPECTION RESULTS:**

THE INSPECTION RESULTS WERE FOUND AS FOLLOWS:

A) QUANTITY AVAILABLE:

	ORDER QUANTITY	REQUESTED INSPECTION QUANTITY	LOT SIZE	ACTUAL AVAILABLE QUANTITY (SHIPMENT)		NOT FINISHED QUANTITY	SAMPLING SIZE FROM	
				PACKED	NOT PACKED		PACKED QUANTITY	NOT PACKED QUANTITY
NO. OF PIECE	2,750	2,750	2,750	2,750	0	0	125	0
NO. OF CARTON	2,750	2,750	2,750	2,750	0	0	125	

NOTE:

1. CARTON SELECTED FOR SAMPLING : CARTON NO. WAS NOT ASSIGNED YET.

B) PRODUCT DESCRIPTION, STYLE AND COLOUR:

CHECK AGAINST P.O./SPECIFICATION PROVIDED BY CLIENT

- The inspected samples were found similar to the description of PO/specification.

NO SUBMITTED SAMPLE WAS PROVIDED BY APPLICANT OR SUPPLIER FOR STYLE & COLOUR COMPARISON

CHECK AGAINST THE INSTRUCTION MANUAL SUBMITTED BY CLIENT

- Discrepancy was found on the Instruction Manual. Please refer to Special Attention point 1

\*\*\*\*\*

**INSPECTION RESULTS:**

THE RESULTS REFLECT OUR FINDINGS AT TIME AND PLACE OF INSPECTION. THIS REPORT DOES NOT RELIEVE SELLERS/MANUFACTURERS FROM THEIR CONTRACTUAL LIABILITIES OR PREJUDICE BUYERS' RIGHT FOR COMPENSATION FOR ANY APPARENT AND/OR HIDDEN DEFECTS NOT DETECTED DURING OUR RANDOM INSPECTION OR OCCURRING THEREAFTER. THIS REPORT DOES NOT EVIDENCE SHIPMENT.



TO : DEUBA BMBH & CO KG - MARGARITA WANG/KRAUS/ALINA LI/DANIEL BEHRENS/UDO SCHAFFER  
C.C. : INTERTEK CONSUMER GOODS GMBH - GREY BAXTER

NUMBER: SHIJ894611 (1<sup>ST</sup> REVISED)  
THIS IS TO SUPERSEDE REPORT SHIJ894611 DATED SEP 10, 2020

**INSPECTION RESULTS:**

**C) WORKMANSHIP:**

DETAILS OF NONCONFORMITY (DEFECTIVES):

*For item#108639(sample size:50 pieces)*  
*scratch mark(3.5cm) on unit*  
*smear printing(0.7cm) on unit*

	<u>CRITICAL</u>	<u>MAJOR</u>	<u>MINOR</u>
	0	0	1
	0	0	1

*For item#108640(sample size:75 pieces)*  
*dirty mark(3-8cm) on unit*  
*incomplete printing(1cm) on unit*

	0	0	2
	0	0	1

ACTUAL FINDING:	0	0	5
ALLOWED:	0	5	7

**D) DATA MEASUREMENT/CHECKING:**

- 1) Assembly check ( 5 Samples/item) : Satisfactory
- 2) Scan the barcode, check scanned No. to match the printed No. on the barcode. Also check the barcode No. to match with the requirement. ( 5 Samples/item) : Not conformed, refer to Special Attention point 4
- 3) Quantity check ( 2 cartons/item) : Satisfactory
- 4) Basic operation check ( 125 samples) : Satisfactory
- 5) Function and performance check ( 5 samples/item) : Satisfactory
- 6) Product measurement ( 5 samples/item) : Not conformed, refer to Special Attention point 3

Item No.	Product size/weight stated on specification	Actual finding product size/weight
108639	Product size: 91.5X32.5X88cm Product weight:14.8kg	Product size: 91.5X32X88cm for all 5 samples(with feet) Product size: 91.5X32X82cm for all 5 samples(without feet) Product weight:14.75kg,14.75kg,14.75kg, 14.8kg,14.8kg(without plastic parts)
108640	Product size: 57x30x83cm Product weight:5.2kg	Product size: 57x29.5x88.8cm for all 5 samples(with plastic feet) Product size: 57x29.5x82cm for all 5 samples(without plastic feet) Product weight:5.3kg,5.3kg,5.3kg,5.3kg, 5.2kg(without plastic parts)



TO : DEUBA BMBH & CO KG - MARGARITA WANG/KRAUS/ALINA LI/DANIEL BEHRENS/UDO SCHAFFER  
C.C. : INTERTEK CONSUMER GOODS GMBH - GREY BAXTER

NUMBER: SHIJ894611 (1<sup>ST</sup> REVISED)  
THIS IS TO SUPERSEDE REPORT SHIJ894611 DATED SEP 10, 2020

- 7) Carton dimension check ( 2 cartons/item) : Satisfactory

Item No.	Master carton size
108639	100.5x16.5x36cm;100.5x16.5x36cm
108640	84x12x36.5cm;84x12x36.5cm

- 8) Carton gross weight check ( 2 cartons/item) : Not conformed, refer to Special Attention point 2

Item No.	Master carton gross weight
108639	16.75kg;16.75kg
108640	6.8kg;6.8kg

- 9) Battery compartment fitting check ( 2 samples/item) : Satisfactory  
-Duracell AAA Alkaline batteries were used for the check.

- 10) Battery reverse check ( 2 samples/item) : Satisfactory

- 11) Moisture content check on wooden part/wooden component ( 5 Samples/item) : Satisfactory

Item No.	Moisture content
108639	9%,9%,11%,9%,10%
108640	13%,13%,13%,13%,12%

- 12) 3 M tape check ( 2 Samples/item) : Satisfactory

- 13) Stability check ( 2 Samples/item) : Satisfactory

- 14) Transportation drop check on master carton ( 1 carton/item) : Satisfactory

\*\*\*\*\*



TO : DEUBA BMBH & CO KG - MARGARITA WANG/KRAUS/ALINA LI/DANIEL BEHRENS/UDO SCHAFFER  
C.C. : INTERTEK CONSUMER GOODS GMBH - GREY BAXTER

NUMBER: SHIJ894611 (1<sup>ST</sup> REVISED)

THIS IS TO SUPERSEDE REPORT SHIJ894611 DATED SEP 10, 2020

**INSPECTION RESULTS:**

**E) FORM OF PACKAGING:**

– For all items

Each set with manual, service card and accessories were packed into a master carton, then sealed with gummed tapes.

Discrepancy was found, refer to Special Attention point 5,6,7

**F) SHIPPING MARKS:**

**WIDER SIDE (BOTH OPPOSITE SIDES)**



**NARROWER SIDE (BOTH OPPOSITE SIDES)**



\*\*\*\*\*



TO : DEUBA BMBH & CO KG - MARGARITA WANG/KRAUS/ALINA LI/DANIEL BEHRENS/UDO SCHAFFER  
C.C. : INTERTEK CONSUMER GOODS GMBH - GREY BAXTER

NUMBER: SHIJ894611 (1<sup>ST</sup> REVISED)  
THIS IS TO SUPERSEDE REPORT SHIJ894611 DATED SEP 10, 2020

**NOTE**

1. The breakdown quantity per each PO/item was shown as below:

Item	PO quantity (PCS/CTN)	Actual quantity (PCS/CTN)	Sample size (PCS/CTN)
108639	1100/1100	1100/1100	50/50
108640	1650/1650	1650/1650	75/75
Total:		2750/2750	125/125

2. The factory refused to seal defect samples and production samples on spot.

For avoid mould growth on product or packaging material, client is recommended to require vendor / factory / logistic service provider / store managers, to well control the storage condition and shipping condition for avoid any damage to products. Moisture content and humidity of the manufacturing plant should be measured and assessed, including monitoring of packaging materials, general housekeeping, etc. The moisture prevention procedure should also be implemented in shipment, transportation and finished products handling in distribution center and store.

\*\*\*\*\*

AUTHORIZED BY:

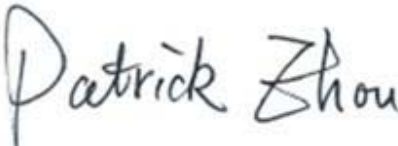

---

PATRICK ZHOU  
GENERAL MANAGER  
INSPECTION DIVISION CHINA





PHOTO ATTACHMENT

For 108639



01 defect-minor-scratch mark (3.5cm) on unit



02 defect-minor-smear printing (0.7cm) on unit

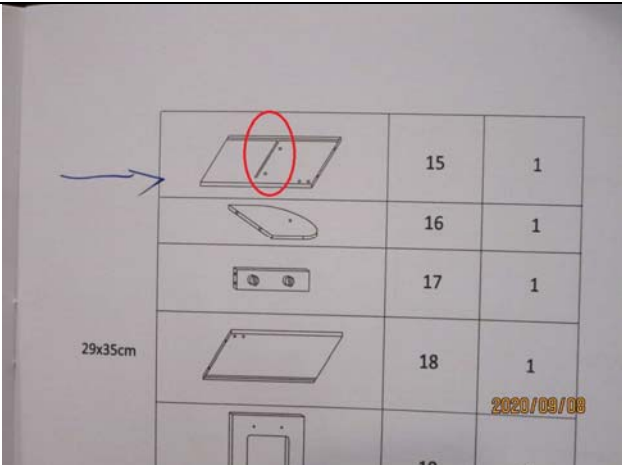

03 special attention 1-a-stated on instruction manual



04 special attention 1-a-actual finding

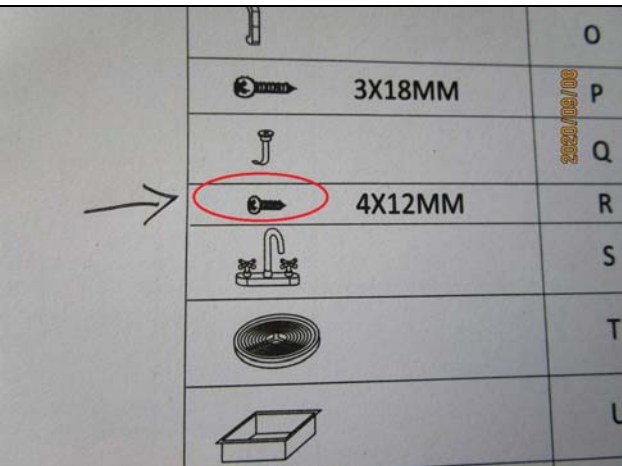

05 special attention 1-b-stated on instruction manual



06 special attention 1-b-actual finding



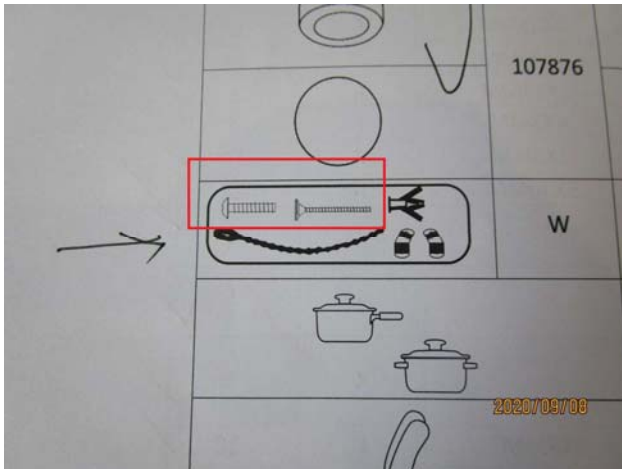

06 special attention 1-b-stated on instruction manual



07 special attention 1-b-actual finding

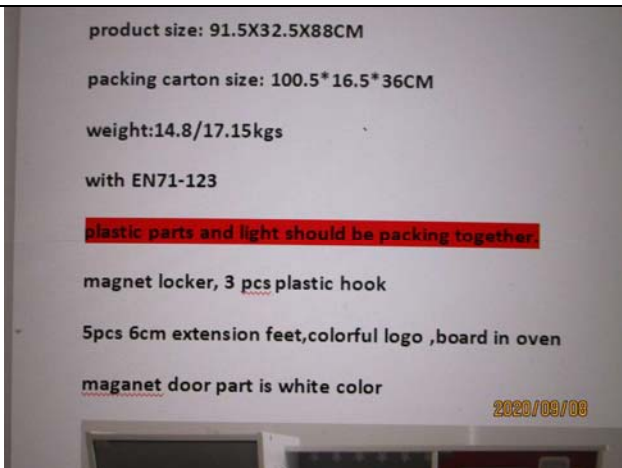

08 special attention 5-stated on specification



09 special attention 5-actual finding (1)



09 special attention 5-actual finding (2)



09 special attention 5-actual finding (3)







10 special attention 7-actual finding for age warning symbol size (1)



10 special attention 7-actual finding for age warning symbol size (2)



11 lot storage (1)



11 lot storage (2)



11 lot storage (3)



11 master carton





12 sampling chop



13 printing on master carton (01)



13 printing on master carton (02)



13 printing on master carton (03)

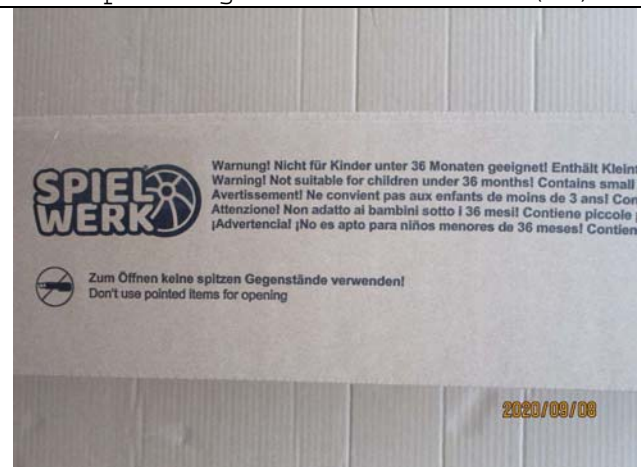

13 printing on master carton (04)

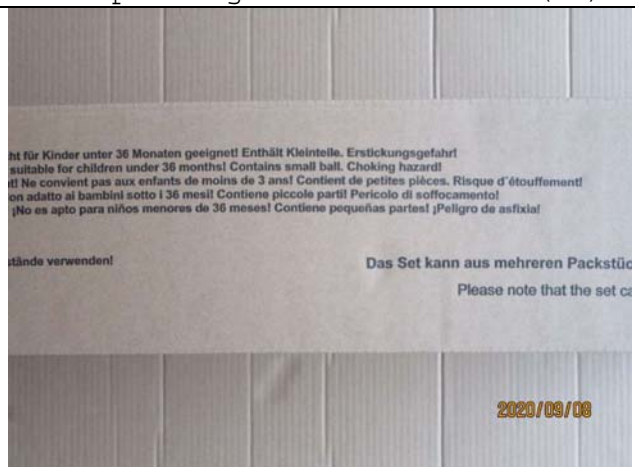

13 printing on master carton (05)





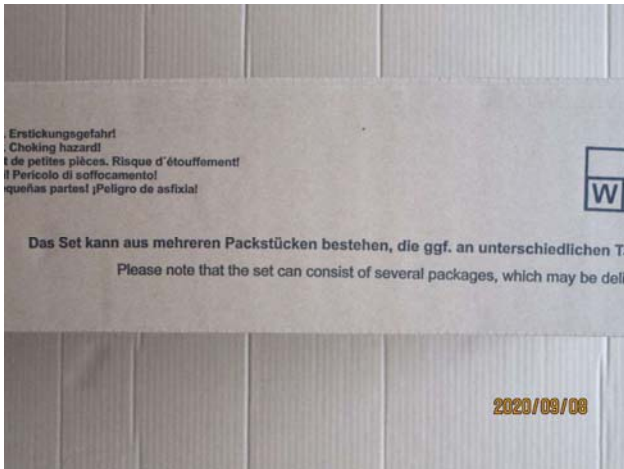

13 printing on master carton (06)



13 printing on master carton (07)



13 printing on master carton (08)



13 printing on master carton (09)



13 printing on master carton (10)



14 label stuck on master carton (1)





14 label stuck on master carton (2)



15 barcode scanning check (1)



15 barcode scanning check (2)



16 qr code check



17 packing method inside master carton (1)



17 packing method inside master carton (2)







17 packing method inside master carton (3)



17 packing method inside master carton (4)



18 service card (1)



18 service card (2)

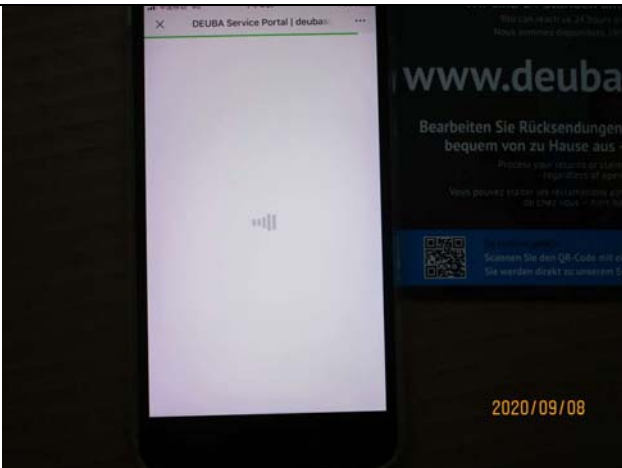

19 qr code check



20 sticker (1)





20 sticker (2)

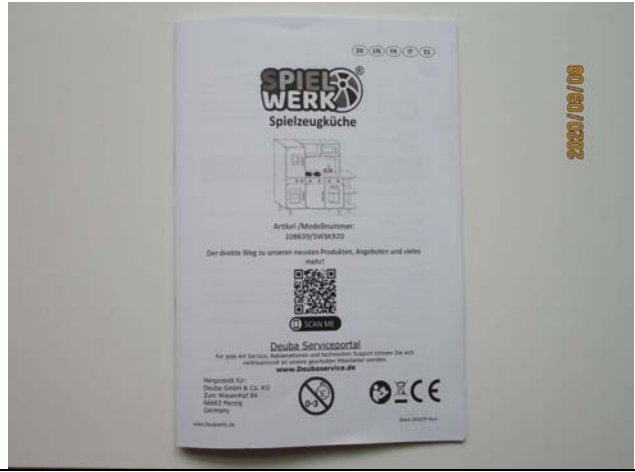

21 instruction manual (01)



21 instruction manual (02)

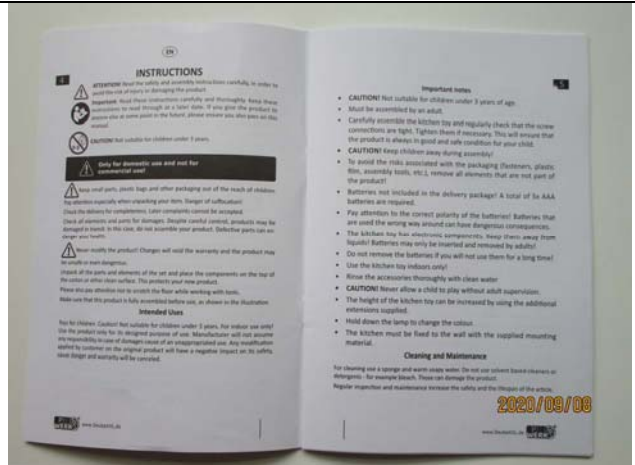

21 instruction manual (03)

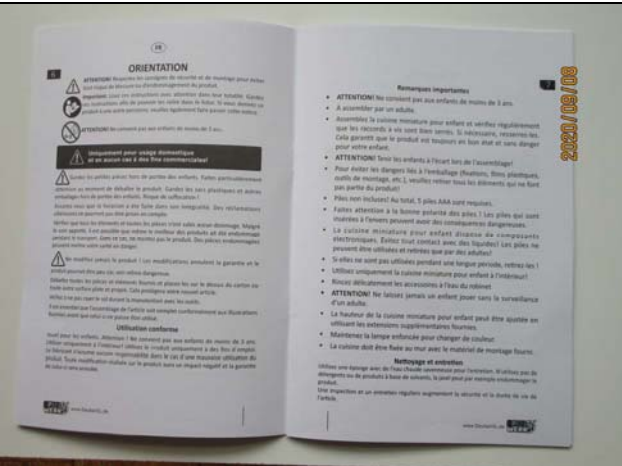

21 instruction manual (04)

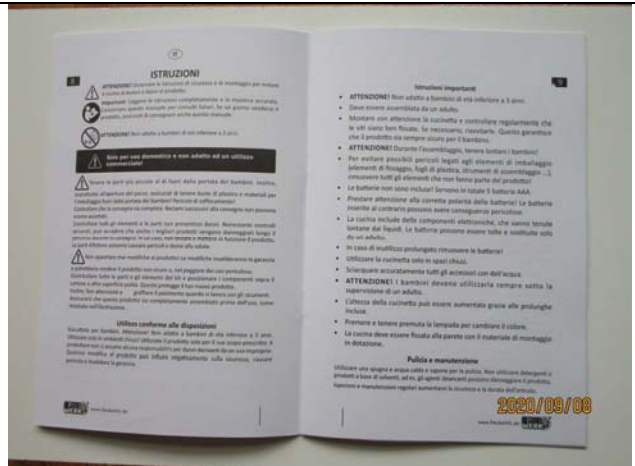

21 instruction manual (05)

THE RESULTS REFLECT OUR FINDINGS AT TIME AND PLACE OF INSPECTION. THIS REPORT DOES NOT RELIEVE SELLERS/MANUFACTURERS FROM THEIR CONTRACTUAL LIABILITIES OR PREJUDICE BUYERS' RIGHT FOR COMPENSATION FOR ANY APPARENT AND/OR HIDDEN DEFECTS NOT DETECTED DURING OUR RANDOM INSPECTION OR OCCURRING THEREAFTER. THIS REPORT DOES NOT EVIDENCE SHIPMENT.







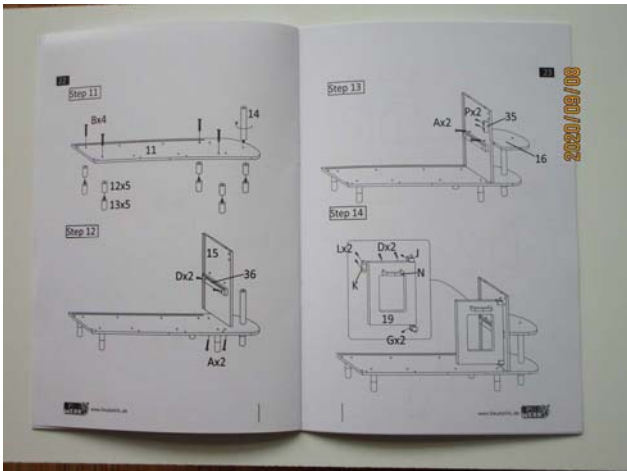

21 instruction manual (12)

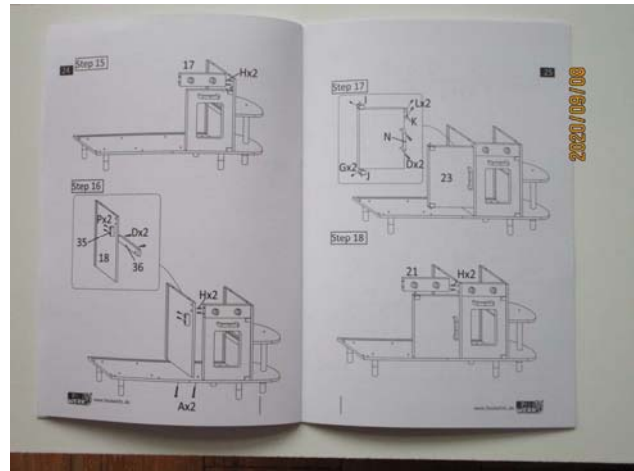

21 instruction manual (13)

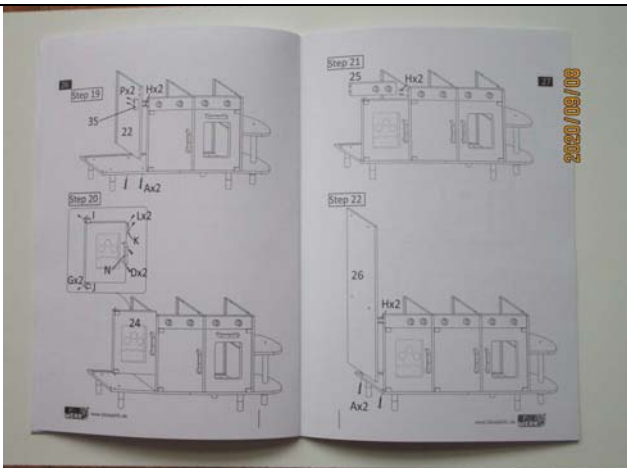

21 instruction manual (14)

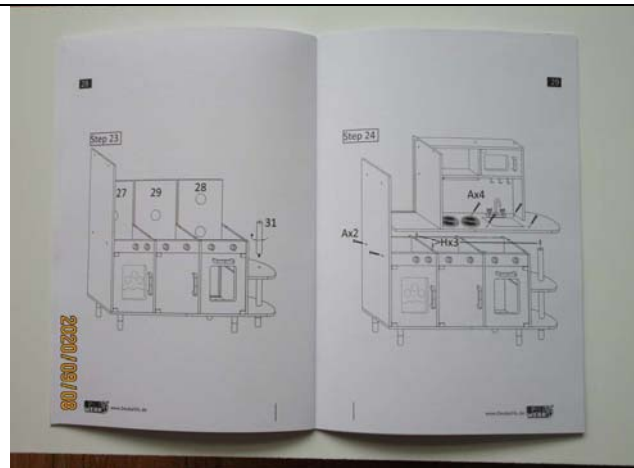

21 instruction manual (15)

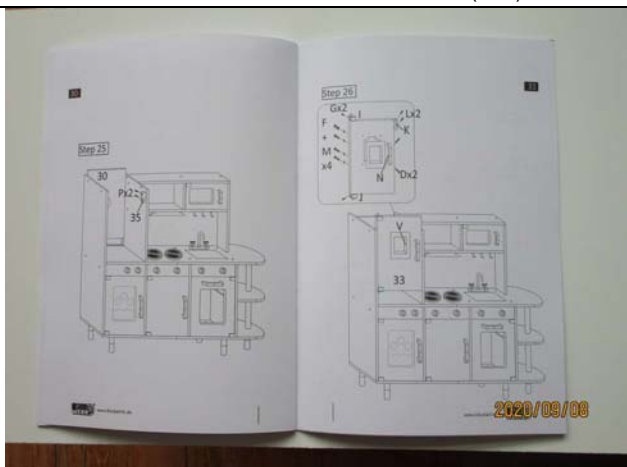

21 instruction manual (16)

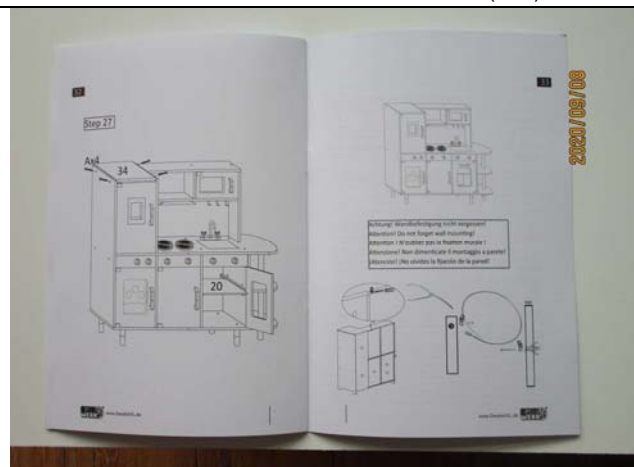

21 instruction manual (17)





21 instruction manual (18)

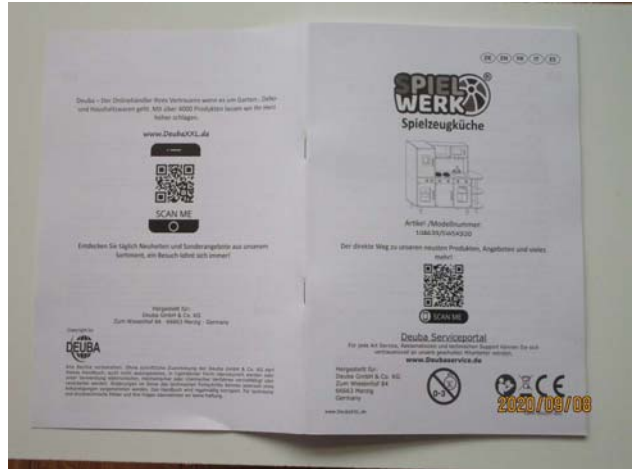

21 instruction manual (19)

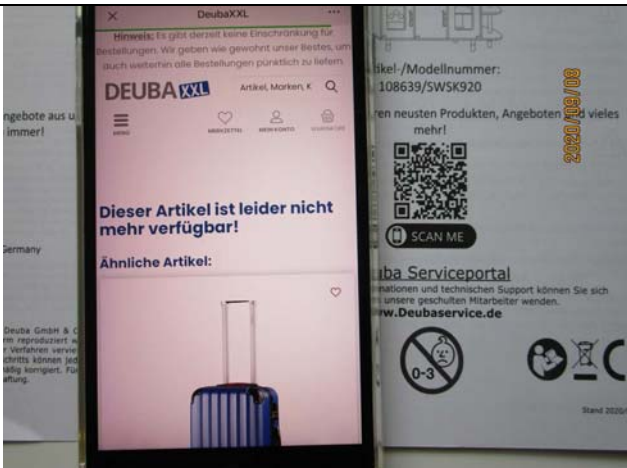

22 qr code check (1)

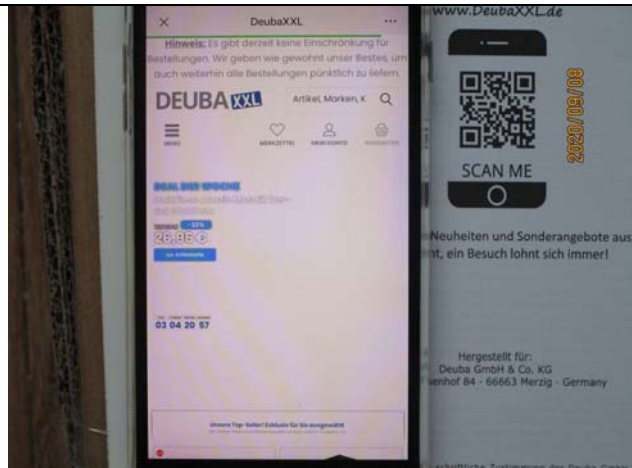

22 qr code check (2)



23 printing on polybag (1)



23 printing on polybag (2)







23 printing on polybag (3)



24 product view



25 accessories view (1)



25 accessories view (2)



25 accessories view (3)



25 accessories view (4)





26 product details view (01)



26 product details view (02)



26 product details view (03)



26 product details view (04)



26 product details view (05)



26 product details view (06)







26 product details view (07)



26 product details view (08)



26 product details view (09)



26 product details view (10)



26 product details view (11)



26 product details view (12)





26 product details view (13)



26 product details view (14)



26 product details view (15)



27 qr code check



28 battery compartment fitting check (1)



28 battery compartment fitting check (2)







29 battery reverse check (1)



29 battery reverse check (2)



30 moisture content check



31 3m tape check (1)



31 3m tape check (2)



32 stability check







33 application check (1)



33 application check (2)



33 application check (3)



33 application check (4)

-NA-



34 carton drop check



For 108640



00 defect-minor-dirty mark(3-8cm) on unit (1)



00 defect-minor-dirty mark(3-8cm) on unit (2)

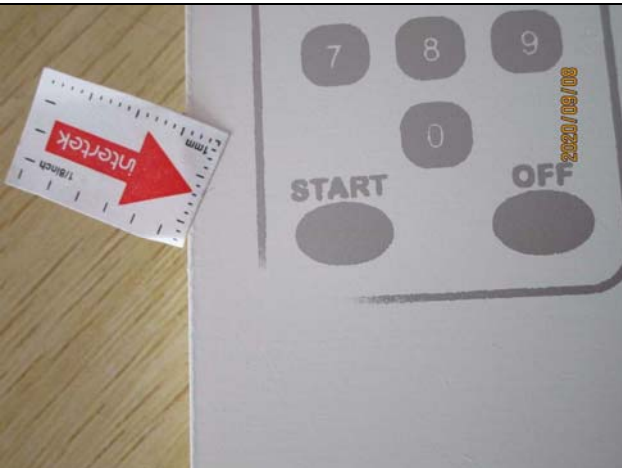

01 defect-minor-incomplete printing(1cm) on unit

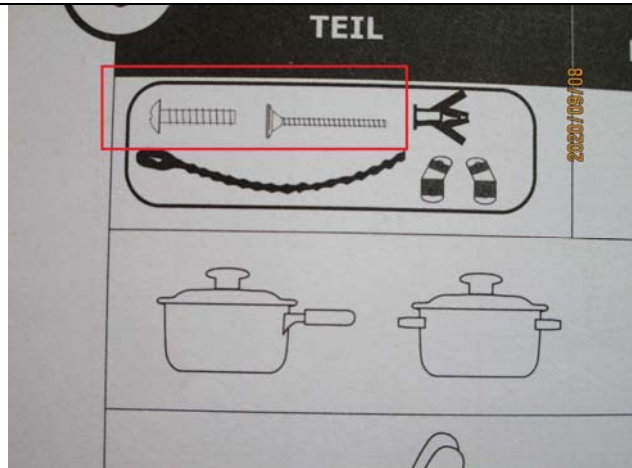

02 special attention 1-b-stated on instruction manual



03 special attention 1-b-actual finding

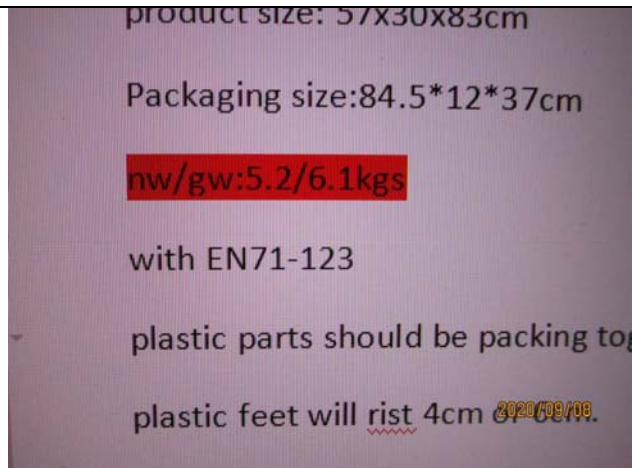

04 special attention 2-stated on specification







05 special attention 2-actual finding

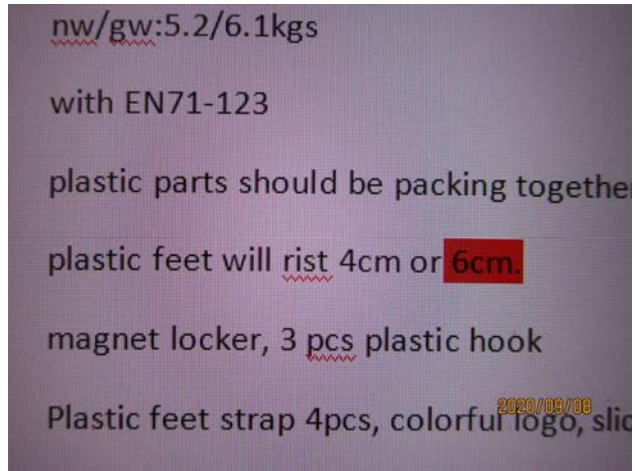

06 special attention 3-stated on specification



07 special attention 3-actual finding (1)



07 special attention 3-actual finding (2)



07 special attention 3-actual finding (3)



07 special attention 3-actual finding (4)



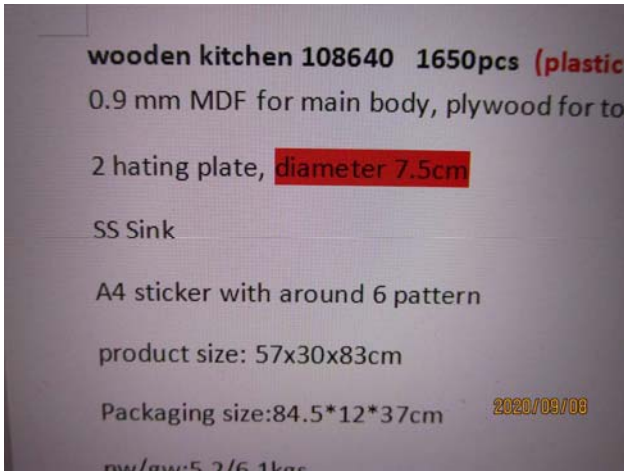

08 special attention 3-stated on specification



09 special attention 3-actual finding

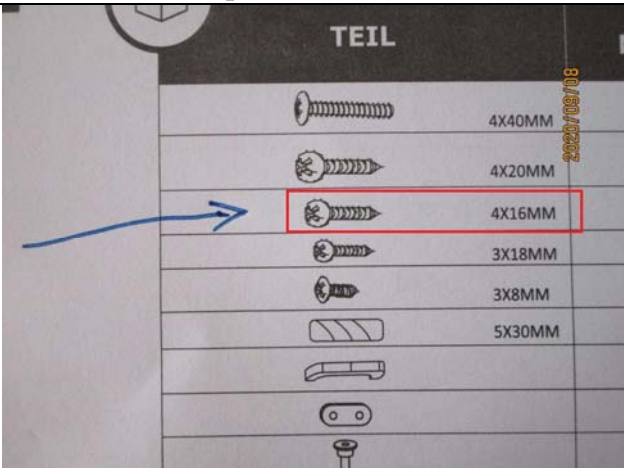

10 special attention 3-stated on instruction manual

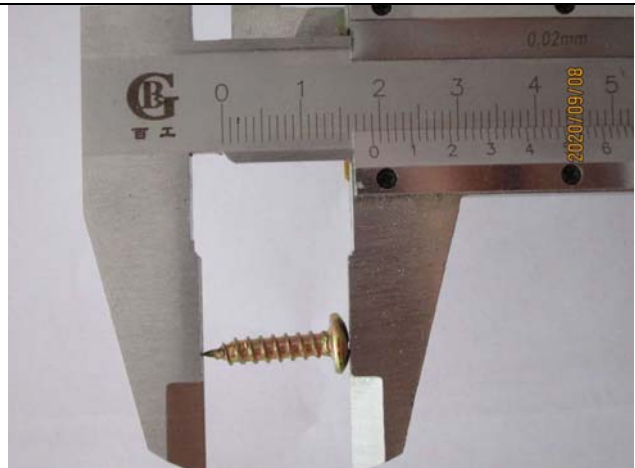

11 special attention 3- actual finding



12 special attention 7-actual finding for age warning symbol size



13 master carton







13 printing on master carton (01)



13 printing on master carton (02)



13 printing on master carton (03)



13 printing on master carton (04)



13 printing on master carton (05)



13 printing on master carton (06)



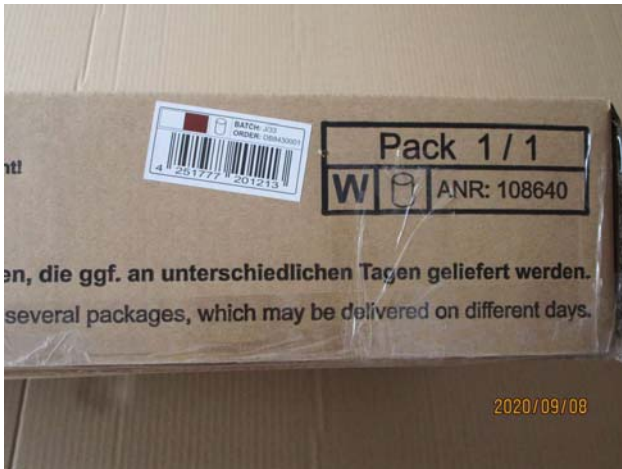

13 printing on master carton (07)



13 printing on master carton (08)

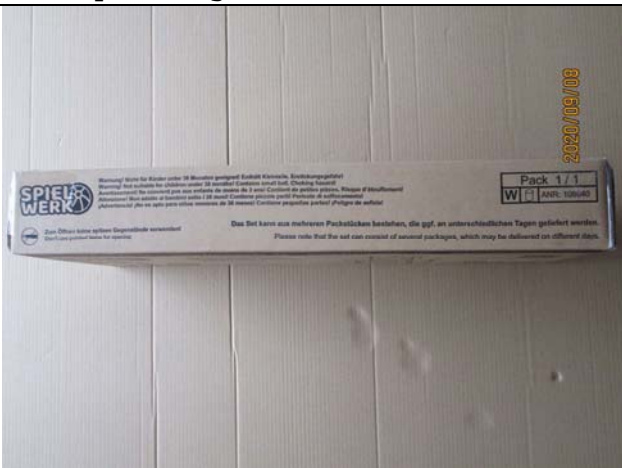

13 printing on master carton (09)



13 printing on master carton (10)



13 printing on master carton (11)



14 label stuck on master carton (1)







14 label stuck on master carton (2)



15 barcode scanning check (1)



15 barcode scanning check (2)

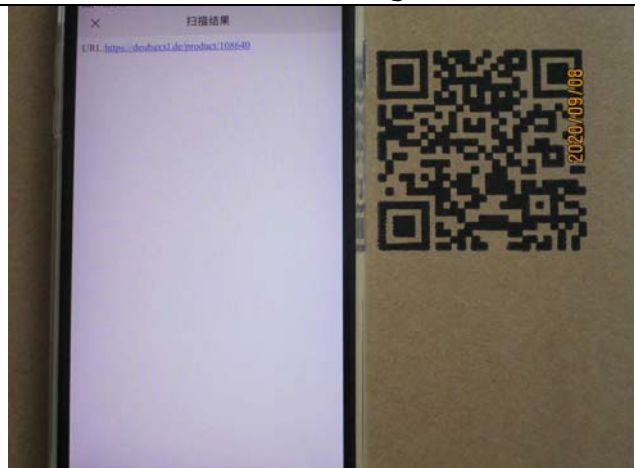

16 qr code check



17 packing method inside master carton (1)



17 packing method inside master carton (2)





17 packing method inside master carton (3)



17 packing method inside master carton (4)



18 service card (1)



18 service card (2)

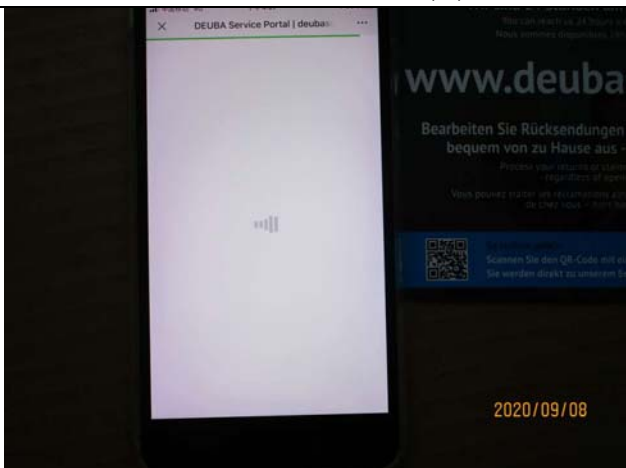

19 qr code check



20 sticker







21 instruction manual (01)

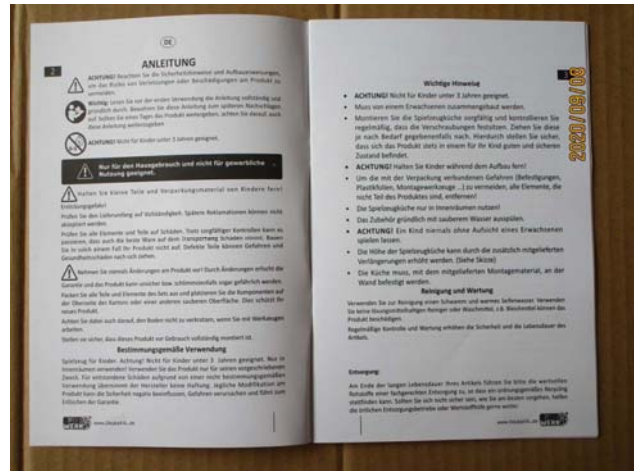

21 instruction manual (02)

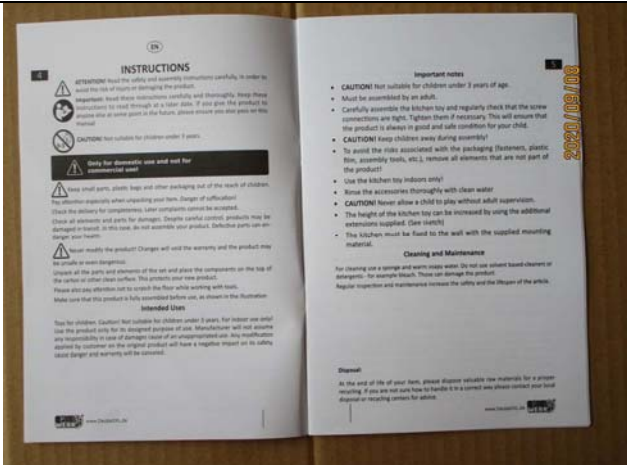

21 instruction manual (03)

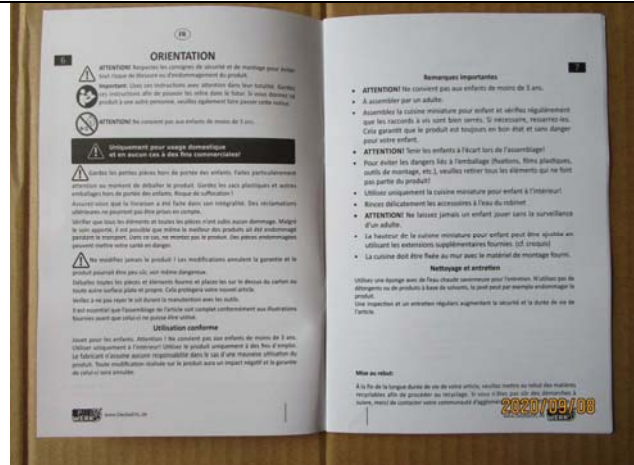

21 instruction manual (04)

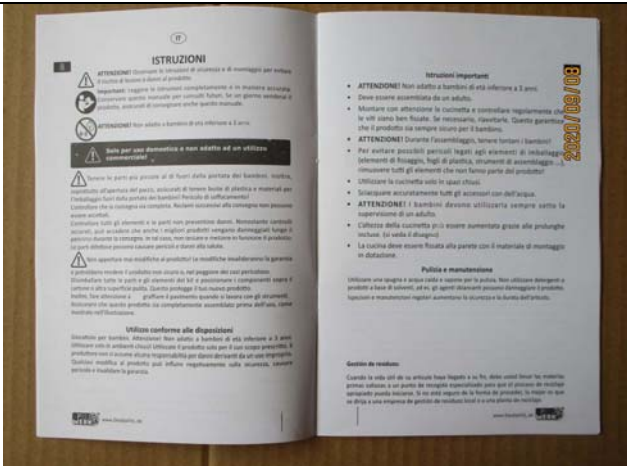

21 instruction manual (05)



21 instruction manual (06)

THE RESULTS REFLECT OUR FINDINGS AT TIME AND PLACE OF INSPECTION. THIS REPORT DOES NOT RELIEVE SELLERS/MANUFACTURERS FROM THEIR CONTRACTUAL LIABILITIES OR PREJUDICE BUYERS' RIGHT FOR COMPENSATION FOR ANY APPARENT AND/OR HIDDEN DEFECTS NOT DETECTED DURING OUR RANDOM INSPECTION OR OCCURRING THEREAFTER. THIS REPORT DOES NOT EVIDENCE SHIPMENT.



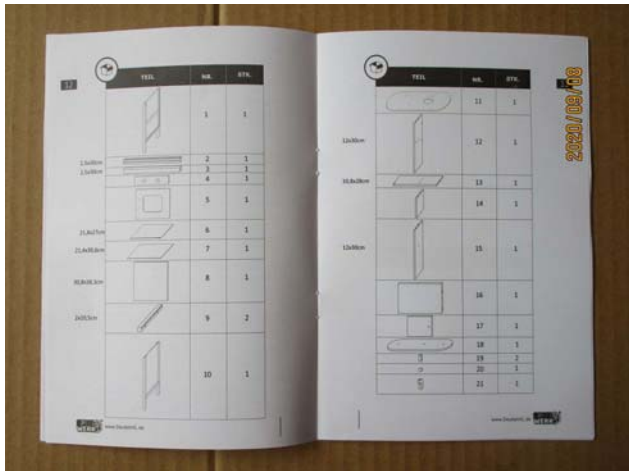

21 instruction manual (07)

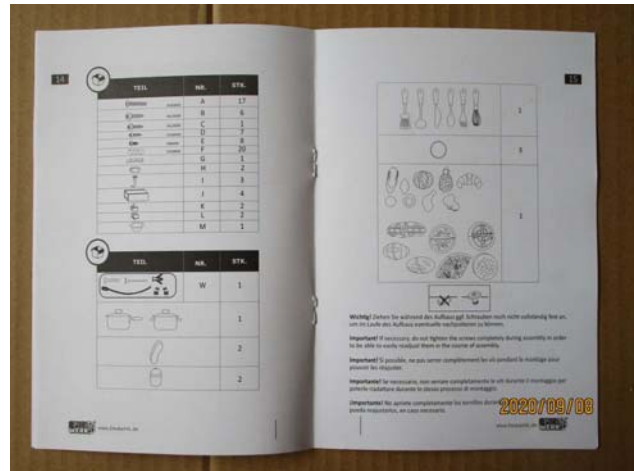

21 instruction manual (08)

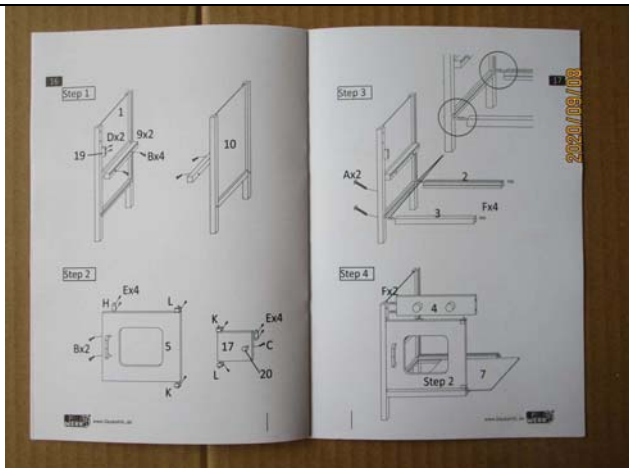

21 instruction manual (09)

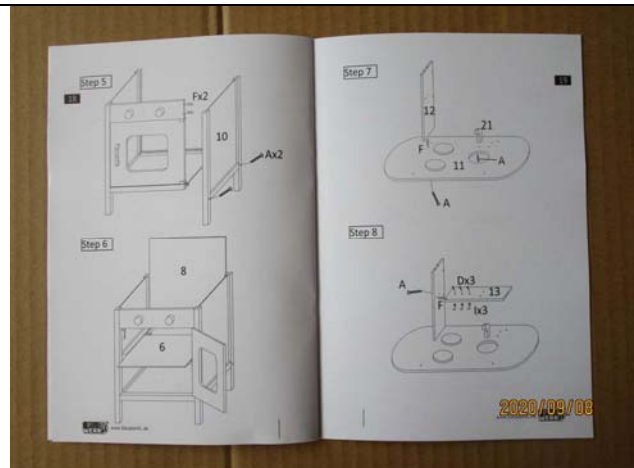

21 instruction manual (10)

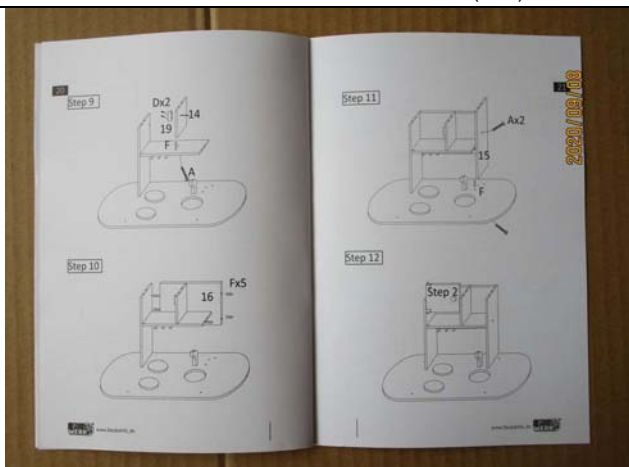

21 instruction manual (11)

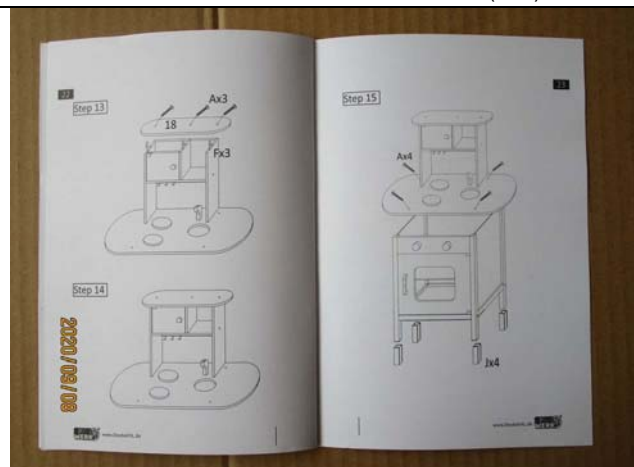

21 instruction manual (12)





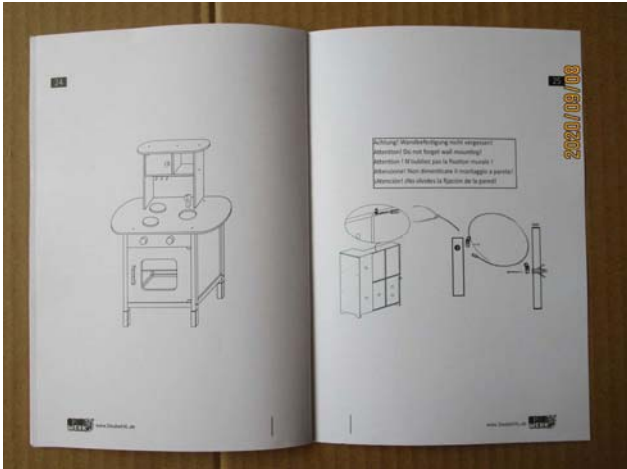

21 instruction manual (13)

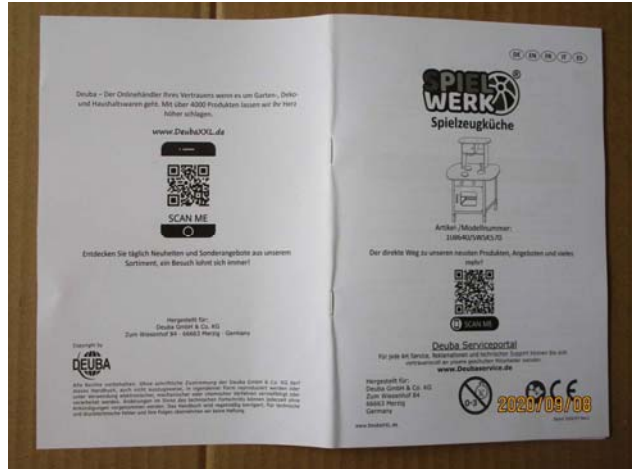

21 instruction manual (14)

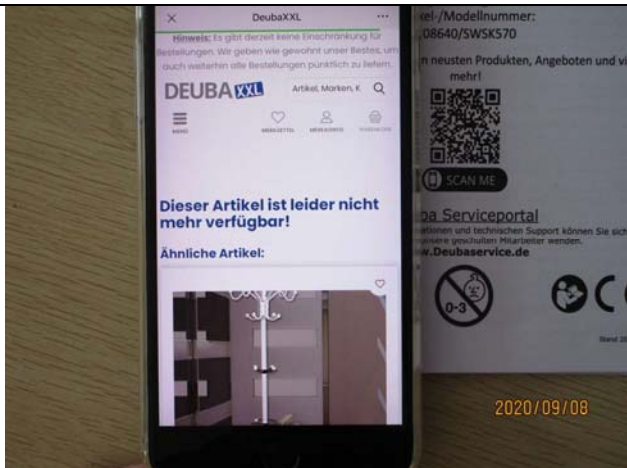

22 qr code check (1)

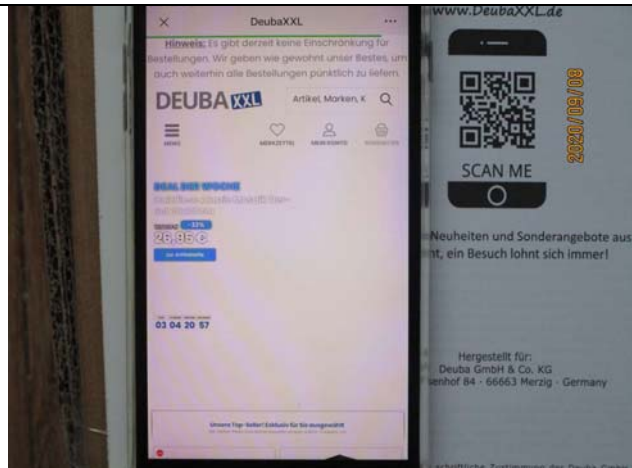

22 qr code check (3)



23 printing on polybag (1)



23 printing on polybag (2)



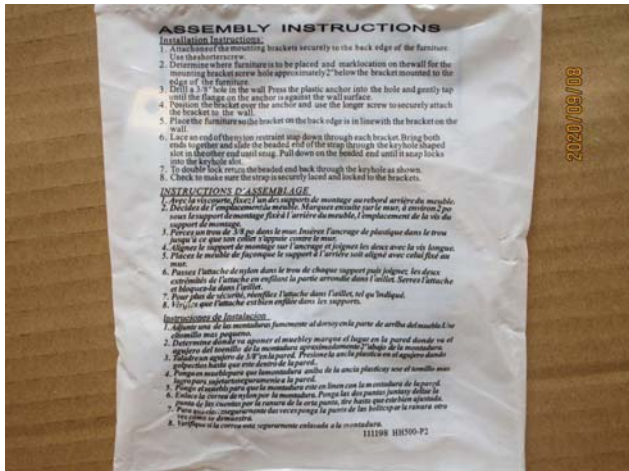

23 printing on polybag (3)



24 product view

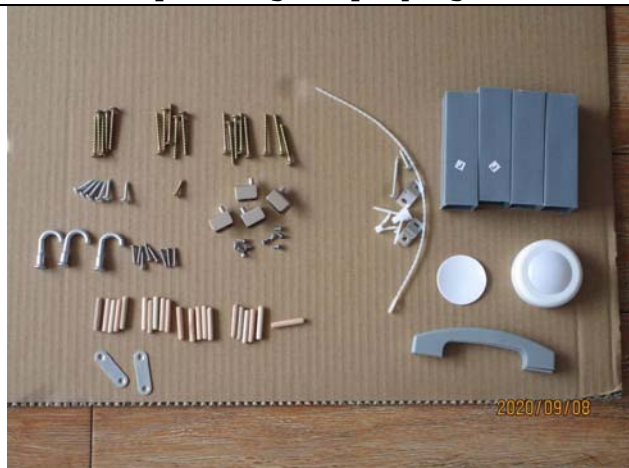

25 accessories view (1)



25 accessories view (2)



26 product details view (01)



26 product details view (02)







26 product details view (03)



26 product details view (04)



26 product details view (05)



26 product details view (06)



26 product details view (07)



26 product details view (08)





26 product details view (10)



26 product details view (11)



26 product details view (12)



26 product details view (9)



27 qr code check



28 battery compartment fitting check







28 battery reverse check



29 moisture content check



30 3m tape check (1)



30 3m tape check (2)



31 stability check



32 application check (1)





32 application check (2)



33 carton drop check

