

Ninebot KickScooter Uživatelský manuál



Producent zastrzega sobie prawo do wprowadzania zmian w produkcji, aktualizacji oprogramowania i aktualizacji tej instrukcji obsługi w dowolnym momencie. Odwiedź stronę www.segway.com lub sprawdź aplikację, aby pobrać najnowsze materiały użytkownika. Musisz zainstalować aplikację, aktywować swojego KickScootera i uzyskać najnowsze aktualizacje i zasady bezpieczeństwa.

www.segway.com

K014P0879-A0



Contents

1 Riding Safety	02
2 Packing List	04
3 Diagram	05
4 Assembling Your KickScooter	06
5 Installing a Second Battery Pack (optional)	07
6 First Ride	08
7 Charging	09
8 Learning to Ride	09
9 Warnings	11
10 Folding and Carrying	15
11 Maintenance	15
12 Specifications	17
13 Certifications	20
14 Trademark and Legal Statement	23
15 Contacts	23

Thanks for choosing the Ninebot KickScooter!

Thanks for choosing the Ninebot KickScooter (hereinafter referred to as KickScooter)!

Your KickScooter is a fashionable transportation device with mobile app, allowing you to connect with other riders. Enjoy your ride and interact with riders worldwide!

This manual is applicable to the following models:

E22 series: E22 / E22D / E22E

E25 series: E25A / E25D / E25E

E45 series: E45 / E45D / E45E

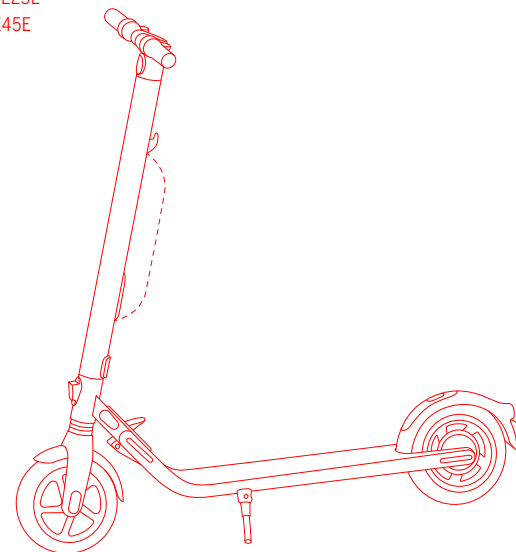

1 Riding Safety

1. The KickScooter is a recreational product. Before mastering riding skills, you need to practice. Neither Ninebot Inc. (means Ninebot (Beijing) Tech Co., Ltd. and its subsidiaries and affiliates) nor Segway Inc. is responsible for any injuries or damage caused by a rider's inexperience or failure to follow the instructions in this document.
2. Please understand that you can reduce the risk by following all the instructions and warnings in this manual, but you cannot eliminate all the risks. Remember that whenever you ride the KickScooter you risk injury from loss of control, collisions, and falls. When entering into public spaces always comply with the local laws and regulations. As with other vehicles, faster speeds require longer braking distance. Sudden braking on low traction surfaces could lead to wheel slip, or falls. Be cautious and always keep a safe distance between you and other people or vehicles when riding. Be alert and slow down when entering unfamiliar areas.
3. Always wear a helmet when riding. Use an approved bicycle or skateboard helmet that fits properly with the chin strap in place, and provides protection for the back of your head.
4. Do not attempt your first ride in any area where you might encounter children, pedestrians, pets, vehicles, bicycles, or other obstacles and potential hazards.
5. Respect pedestrians by always yielding the right of way. Pass on the left whenever possible. When approaching a pedestrian from the front, stay to the right and slow down. Avoid startling pedestrians. When approaching from behind, announce yourself and slow down to walking speed when passing. Please obey local traffic laws and regulations if situation is different.
6. In places without laws, comply with the safety guidelines outlined in this manual. Neither Ninebot Inc. nor Segway Inc. is responsible for any property damage, personal injury/death, accidents, or legal disputes caused by violations of the safety instructions.
7. Do not allow anyone to ride your KickScooter on his/her own unless they have carefully read this manual and followed the New Rider Tutorial in the App. The safety of new riders is your responsibility. Assist new riders until they are comfortable with the basic operation of the KickScooter. Make sure each new rider wears a helmet and other protective gear.
8. Before each ride check for loose fasteners and damaged components. If the KickScooter makes abnormal sounds or signals an alarm, immediately stop riding. Diagnose your KickScooter via the Segway-Ninebot App and call your dealer/distributor for service.
9. Be alert! Scan both far ahead and in front of your KickScooter — your eyes are your best tool for safely avoiding obstacles and low traction surfaces (including, but not limited to, wet ground, loose sand, loose gravel, and ice).
10. To reduce risk of injury, you must read and follow all "CAUTION" and "WARNING" notices in this document. Do not ride at an unsafe speed. Under no circumstance should you ride on roads with motor vehicles. The manufacturer recommends riders be 14+ years old. Always follow these safety instructions:

- A. People who should not ride the KickScooter include:
 - i. Anyone under the influence of alcohol or drugs.
 - ii. Anyone who suffers from disease that puts them at risk if they engage in strenuous physical activity.
 - iii. Anyone who has problems with balance or with motor skills that would interfere with their ability to maintain balance.
 - iv. Anyone whose weight is outside the stated limits (see Specifications).
 - v. Pregnant women.
 - B. Riders under the age of 18 years old should ride under adult supervision.
 - C. Comply with local laws and regulations when riding this product. Do not ride where prohibited by local laws.
 - D. To ride safely, you must be able to clearly see what is in front of you and you must be clearly visible to others.
 - E. Do not ride in the snow, in the rain, or on roads which are wet, muddy, icy, or that are slippery for any reason. Do not ride over obstacles (sand, loose gravel, or sticks). Doing so could result in a loss of balance or traction and could cause a fall.
11. Do not attempt to charge your KickScooter if it, the charger, or the power outlet is wet.
 12. As with any electronic device, use a surge protector when charging to help protect your KickScooter from damage due to power surges and voltage spikes. Only use the Segway supplied charger. Do not use a charger from any other different product models.
 13. Use only Ninebot or Segway approved parts and accessories. Do not modify your KickScooter. Modifications to your KickScooter could interfere with the operation of the KickScooter, result in serious injury and/or damage, and void the Limited Warranty.
 14. Children should not play with the KickScooter or parts of it nor should cleaning or maintenance be done by children. The use of the machine results in the transmission of vibrations throughout the driver's body.
 15. Always place the KickScooter on its stand on a flat and stable surface. The KickScooter must be placed with the stand against the slope to prevent it from tipping over. Never place the KickScooter with the front facing down the slope, as the stand may close and tip the machine. Once the KickScooter is on its stand, check its stability to avoid any risk of falling (by slip, wind or slight jolt). Do not park the KickScooter in a busy area, but rather along a wall. If possible, always choose to park your KickScooter on flat ground.
 16. For a better driving experience, it is recommended to conduct a regular maintenance of the product.
 17. Please read the user manual before charging the battery.
 18. Do not touch the brake system, it could cause injuries.
 19. The A-weighted emission sound pressure level is less than 70 dB(A). The mechanical vibrations transmitted by the KickScooter are less than 2.5 m/s².

2 Packing List

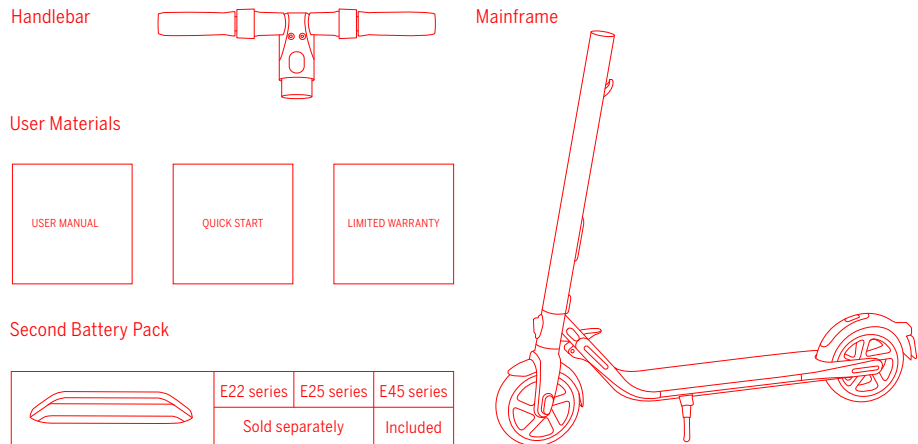

Accessories

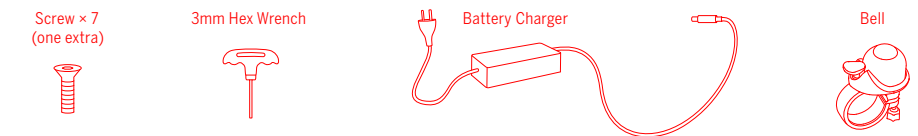

When unboxing your KickScooter, please verify that the above items are included in the package. If any components are missing, please contact your dealer/distributor or nearest service center (see Contacts in the user manual). After verifying that all components are present and in good condition, you can assemble your new KickScooter.

Please retain the box and packaging materials in case you need to ship your KickScooter in the future.

Remember to power off your KickScooter and unplug the charge cable before assembling, mounting accessories, or cleaning the mainframe.

3 Diagram

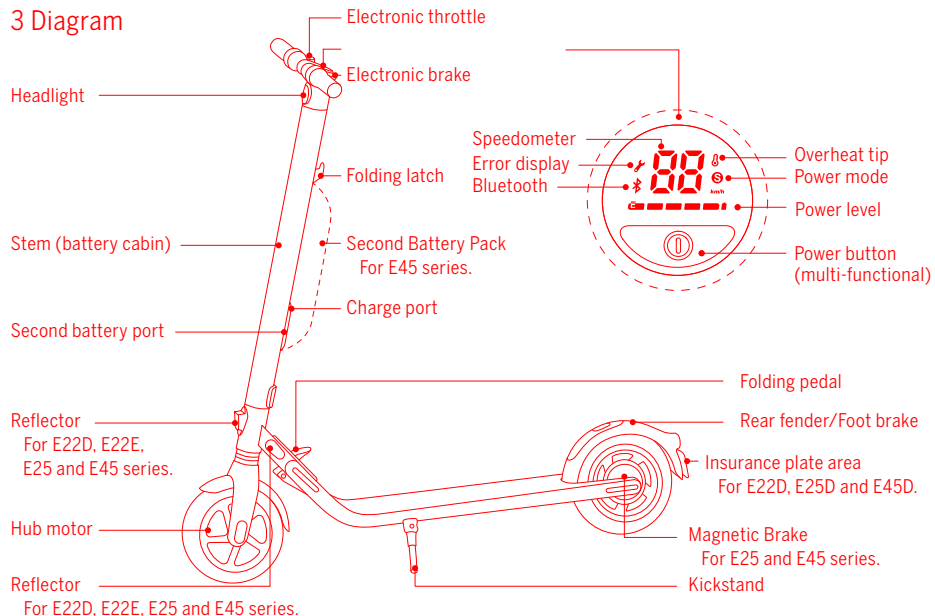

Dashboard & Power button

Speedometer: Indicates the current speed. Also displays error codes when faults are detected.

Battery level: Indicates the remaining battery level with 5 bars. Each bar equates to approximately 20% power level.

Power mode:

- Red "S" icon: Sport mode (maximum power/speed).
- White "S" icon: Standard mode (moderate power/speed).
- No "S" icon: Speed limit mode (minimum power/speed).

Bluetooth: A blinking Bluetooth icon indicates that the vehicle is ready to connect. A solid Bluetooth icon indicates that the vehicle is connected to a mobile device.

Power button: Short press to power on. Long press to power off. When powered on, press to turn on/off the headlight. Double-press to change power mode.

Overheat tip: The thermometer icon always on indicates that the battery temperature has reached 122°F (50°C). At this point, the vehicle cannot accelerate normally and may not be charged. Do not use it until the temperature is restored to normal range.

Error display: The lit wrench icon indicates the scooter error.

4 Assembling Your KickScooter

1. Unfold the stem and push it until you hear a click. Flip up the folding pedal. Then unfold the kickstand to support the scooter.

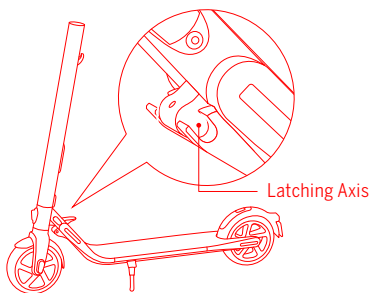

3. Install six screws (two on each side) with the included hex wrench.

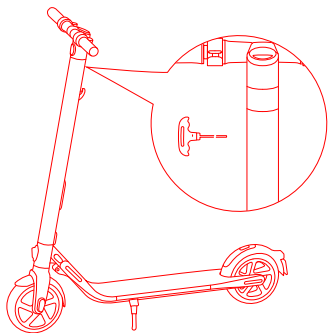

2. Firmly connect the wires inside the handlebar and the stem. Slide the handlebar onto the stem. Be aware of the correct orientation.

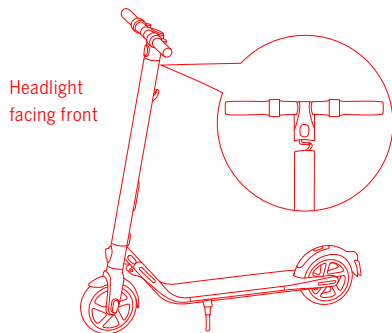

4. Verify that your KickScooter powers on and off.

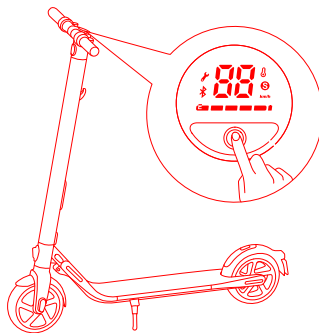

5 Installing a Second Battery Pack (optional) ⚠

1. Remove the three screws on the stem. Then remove the cover near the charge port and remove the M3 screw.

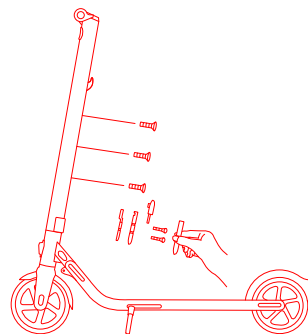

2. Install the rail with the M4 (10mm) screws (3 pcs), provided with this product. Please make sure it is properly fixed.

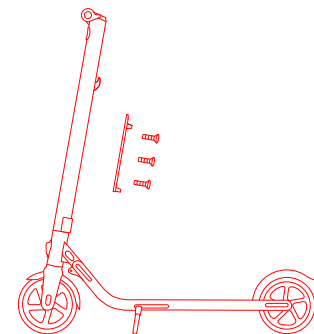

3. Install the external battery on the rail and fix it with the M4 (20mm) screws (2 pcs) and M3 screw (1 pcs), provided with this product. After they are properly installed, block the screw holes with the rubber stopper.

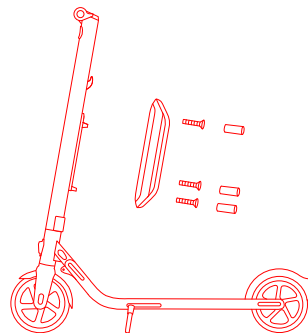

4. Verify that your KickScooter powers on and off.

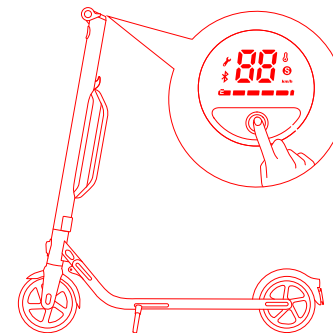

6 First Ride

⚠ There are safety risks when learning to ride the KickScooter. You must read the Riding Safety via the App before your first ride.



Segway-Ninebot App

For your safety, your new KickScooter is not activated and will beep occasionally after POWER ON.

Until activated, the KickScooter maintains a very low riding speed, and can not perform with full function. Install the Segway-Ninebot App on your mobile device (with Bluetooth 4.0 and above), connect to the KickScooter with Bluetooth, and follow the App instructions to activate your KickScooter and enjoy the full performance.

Scan the QR code to download the App (iOS 9.0 and above, Android™ 4.3 and above).

Install the Segway-Ninebot App and register/login.

Power on the KickScooter. A blinking Bluetooth icon indicates the KickScooter is ready to connect.

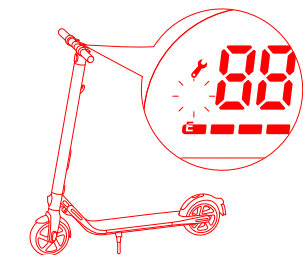
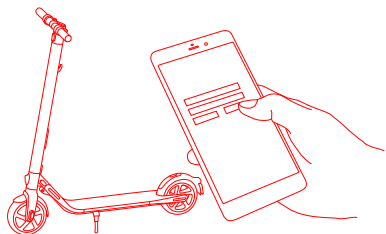

Click "Vehicle" → "Search vehicle" to connect to your KickScooter.

The KickScooter will beep when it has successfully connected. The Bluetooth icon will stop blinking and remain illuminated.

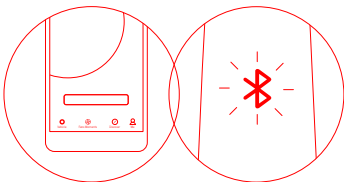

Follow the App instructions to activate the KickScooter and learn how to ride safely.

You can now start to use your KickScooter, check the status with the App, and interact with other users. Have fun!

7 Charging

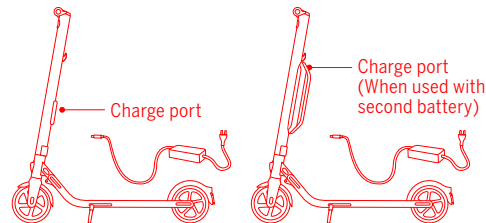

Charging steps:

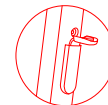

Open the charge port cover.

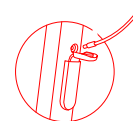

Insert the charge plug.

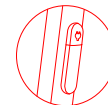

Close the charge port cover when finished.



Your KickScooter is fully charged when the LED on the charger changes from red (charging) to green (trickle charge). Close the charge port cover when not charging.

8 Learning to Ride



Wear an approved helmet and other protective gear to minimize any possible injury.

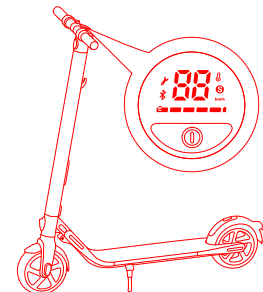

1. Power on the scooter and check the power level. Charge the scooter if the battery level is low.

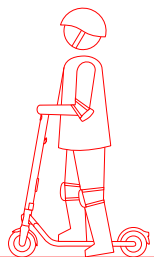

2. Stand on the foot deck with one foot and push off with another foot to start gliding.

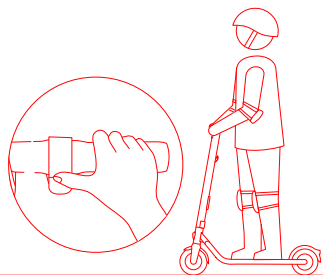

3. Put your other foot on the foot deck to keep both feet stable. Press the throttle to speed up when you are balanced.

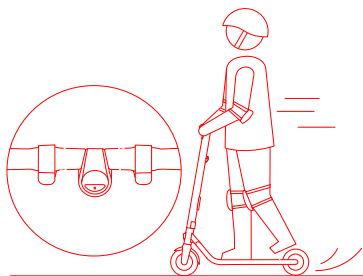

4. Slow down by releasing the throttle. Squeeze the electronic brake and stamp the rear fender with foot at the same time for a sudden brake.

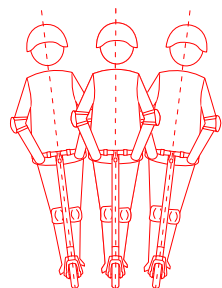



5. To turn, shift your body and turn the handlebar slightly.

9 Warnings

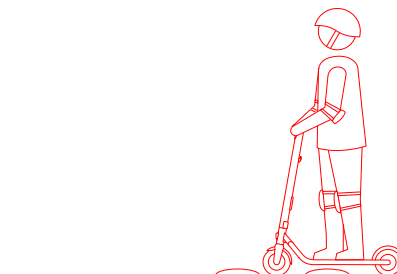

 DO NOT ride the scooter in the rain.



 Keep your speed between 3.1–6.2 mph (5–10 km/h) when you ride through speed bumps, elevator door stills, bumpy roads or other uneven surfaces. Slightly bend your knee to better adjust mentioned surfaces.

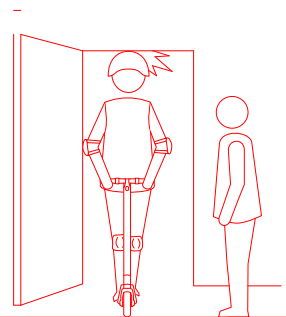

 Watch your head when passing through doorways.

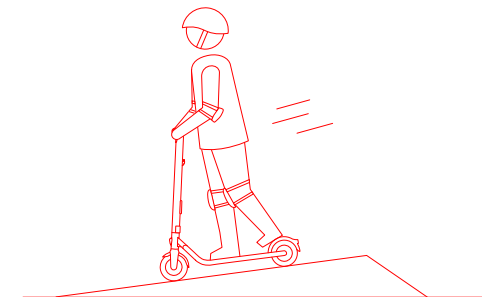

 Watch your speed when traveling downhill. Use both brakes together when traveling at high speed.



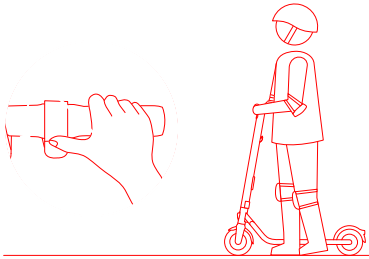

! DO NOT press the throttle when walking with the scooter.

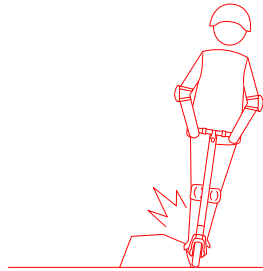

! Avoid contacting obstacles with the tire/wheel.

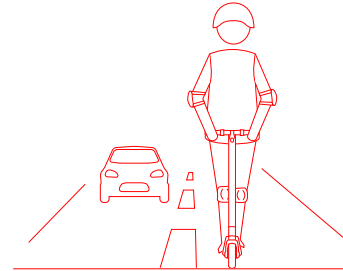

! DO NOT ride on public roads, motorways, or highways.

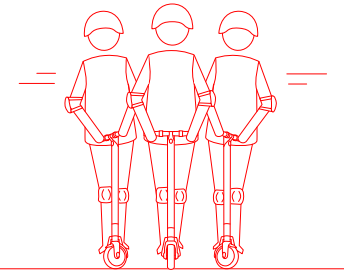

! DO NOT rotate the handlebar violently while driving at high speed.

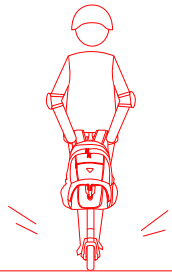

! DO NOT carry heavy objects on the handlebar.

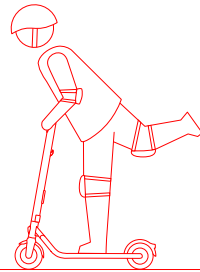

! DO NOT ride the scooter with only one foot.



! Do not ride through puddles or any other (water) obstacles. In such a case please lower your speed and bypass the obstacle.

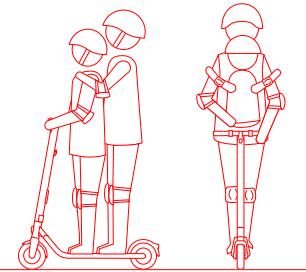

! The KickScooter is for one rider only. Do not ride with another person. Do not carry a child.

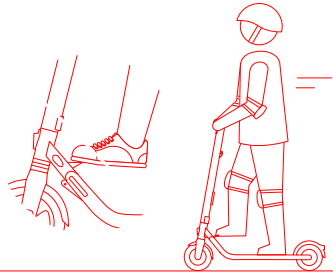

! DO NOT step on the folding pedal while riding.

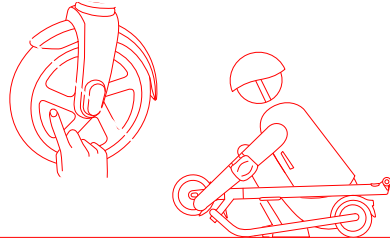

! DO NOT touch the hub motor after riding because it can get hot.

10 Folding and Carrying

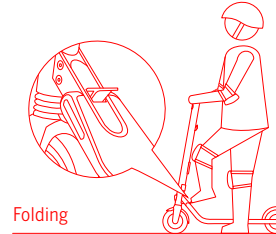

Folding
Step on the folding pedal while pushing the handlebar forward slightly.

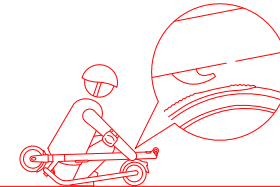

Then fold the handlebar down until it locks into the rear fender.

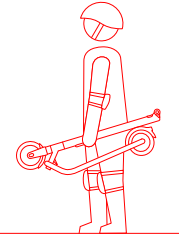

When your KickScooter is folded up, simply lift it by the stem to carry.

11 Maintenance

Use a soft, wet cloth to wipe the mainframe clean. Hard to remove dirt can be scrubbed with a toothbrush and toothpaste, then cleaned with a soft, wet cloth.

Do not wash your KickScooter with alcohol, gasoline, acetone, or other corrosive/volatile solvents. These substances may damage the appearance and internal structure of your KickScooter. Do not wash your KickScooter with a power washer or hose.



Make sure the KickScooter is powered OFF, the charging cable is unplugged, and the rubber cap on the charge port is tightly sealed before cleaning; otherwise you may damage the electronic components.

Store your KickScooter in a cool, dry place. Do not store it outdoors for extended periods of time. Exposure to sunlight and temperature extremes (both hot and cold) will accelerate the aging process of the plastic components and may reduce battery life.

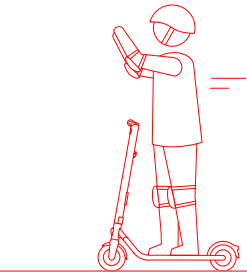

! DO NOT take your hands off the handlebar while riding. Do not ride with one hand only.

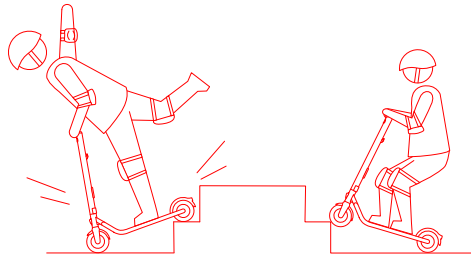

! DO NOT ride up and down stairs or jump over obstacles.



Do not remove the battery. Removing the battery is complicated and can alter the operation of the machine: You can contact an authorized repairer if the product is still guaranteed. If the product is not guaranteed you can contact any specialized repairer of your choice. You can ask for the list of the authorized repairers to the customer service available at www.segway.com. For any further question, you can contact the customer service available at www.segway.com.

Do not store or charge the battery at temperatures outside the stated limits (see Specifications). Do not puncture the battery. Refer to your local laws and regulations regarding battery recycling and/or disposal. A well maintained battery can perform well even after many miles of riding. Charge the battery after each ride and avoid draining the battery completely. When used at room temperature (70°F [22°C]) the battery range and performance is at its best; whereas using it at temperatures below 32°F (0°C) can decrease range and performance. Typically, at -4°F (-20°C) range can be half that of the same battery at 70°F (22°C). Battery range will recover when temperature rises. More details are available in the App.

Tires supplied with the product are to be mounted on the wheel by a professional repairer. Removing the wheels is complicated and incorrect assembly can lead to instability and malfunctions:

- Please contact an authorized repairer if the product is still under manufacturer guarantee. You can ask for the list of the authorized repairers to the customer service available at www.segway.com.
- If the product is no longer under guaranteed you can contact any specialized repairer of your choice.
- Should you have questions, you can contact customer service available at www.segway.com.

Typically, a fully charged battery should retain charge for 120-180 days in Standby Mode. A low-power battery should retain charge for 30-60 days in Standby Mode. Remember to charge the battery after each use. Completely draining the battery may cause permanent damage to the battery. Electronics inside the battery record the charge-discharge condition of the battery; damage caused by over-discharge or under-discharge will not be covered by the Limited Warranty.



Do not charge or use your battery if it is damaged or see trace of water. Do not attempt to disassemble the battery. Risk of fire. No user serviceable parts.



Do not ride when the ambient temperature is outside the machine operation temperature (see Specifications) because low/high temperature will limit the maximum power/torque. Doing so could cause personal injury or property damage due to slips or falls.

The external flexible cable of this transformer cannot be replaced; if the cord is damaged, the transformer must be discarded and replaced by a new one. Should you have questions, you can contact customer service available at www.segway.com.

In case of accident or breakdown: Please contact an authorized repairer if the product is still under guarantee. If not, you can contact any specialized repairer of your choice. You can ask for the list of the authorized repairers to the customer service available at www.segway.com. For any question, please contact customer service available at www.segway.com.

Efforts have been made to simplify wording in the user manual for users. Where an action appears too complicated for a user, he is advised to contact an authorized or a specialized repairer or customer service.

12 Specifications

	Item	E22E/E22D	E22
Dimensions	Length x Width x Height	43.7 × 16.5 × 44.1 in (111 × 42 × 112 cm)	42.9 × 16.5 × 44.1 in (109 × 42 × 112 cm)
	folded: Length x Width x Height	44.9 × 16.5 × 14.2 in (114 × 42 × 36 cm)	44.5 × 16.5 × 14.2 in (113 × 42 × 36 cm)
Weight	Net Weight	Approx. 29.8 lbs (13.5kg)	
Rider	Payload	55–220 lbs (25–100 kg)	
	Recommended Age	14+ years	
	Required Height	3'11" – 6'6" (120–200 cm)	
Parameters	Max. Speed	12.4 mph (20 km/h)	
	Typical Range ^[1]	13.7 miles (22 km)	
	Max. Slope	15%	
	Traversable Terrain	asphalt/flat pavement; obstacles < 0.4 in (1 cm); gaps < 1.2 in (3 cm)	
	Operating Temperature	14–104°F (-10–40°C)	
	Storage Temperature	-4–122°F (-20–50°C)	
	IP Rating	IPX4	
	Duration of Charging	Approx. 3.5 h	
Battery	Nominal Voltage	36 V ===	
	Max. Charging Voltage	42 V ===	
	Nominal Energy	184 Wh	
	Nominal Capacity	5100 mAh	
	Battery Management System	Over-heating, short circuit, over-current, over-discharge and over-charge protection	
Motor	Number of Batteries ^[2]	1	
	Nominal Power	300 W, 0.3 kW	
Charger	Output Power	71 W, 0.071 kW	
	Input Voltage	100–240 V-	
	Output Voltage	42 V ===	
	Output Current	1.7 A	
Features	Brake Light	LED rear light	
	Riding Modes	Speed limit mode, Standard mode and Sport mode	
Tire	Tires	Dual Density Tires. Material: synthetic rubber. Size: 9 inches	

[1] Typical Range: tested while riding under full power, 165 lbs (75 kg) load, 77°F (25°C), 60% of max. speed on average on pavement.

* Some of the factors that affect range include: speed, number of starts and stops, ambient temperature, etc.

[2] All KickScooter models could install the second battery. Some of the parameters would change in this case.

	Item	E25D	E25E	E25A
Dimensions	Length x Width x Height	45.7 × 16.5 × 46.1 in (116 × 42 × 117 cm)		
	folded: Length x Width x Height	46.9 × 16.5 × 14.2 in (119 × 42 × 36 cm)		
Weight	Net Weight	31.7 lbs (14.4 kg)		
	Payload	55–220 lbs (25–100 kg)		
Rider	Recommended Age	14+ years		
	Required Height	3'11"–6'6" (120–200 cm)		
Parameters	Max. Speed	12.4 mph (20 km/h)	15.5 mph (25 km/h)	17.4 mph (28 km/h)
	Typical Range ^[1]	15.5 miles (25 km)		
	Max. Slope	15%		
	Traversable Terrain	asphalt/flat pavement; obstacles < 0.4 in (1 cm); gaps < 1.2 in (3 cm)		
	Operating Temperature	14–104°F (-10–40°C)		
	Storage Temperature	-4–122°F (-20–50°C)		
	IP Rating	IPX4		
	Duration of Charging	Approx. 4 h		
Battery	Nominal Voltage	36 V ===		
	Max. Charging Voltage	42 V ===		
	Nominal Energy	215 Wh		
	Nominal Capacity	5960 mAh		
	Battery Management System	Over-heating, short circuit, over-current, over-discharge and over-charge protection		
	Number of Batteries ^[2]	1		
Motor	Nominal Power	300 W, 0.3 kW		
	Output Power	71 W, 0.071 kW		
Charger	Input Voltage	100–240 V~		
	Output Voltage	42 V ===		
	Output Current	1.7 A		
Features	Brake Light	LED rear light		
	Shock Absorber	Front		
	Riding Modes	Speed limit mode, Standard mode and Sport mode		
	Ambient Light	/	Customizable colour	Customizable colour
Tire	Tires	Dual Density Tires. Material: synthetic rubber. Size: 9 inches		

[1] Typical Range: tested while riding under full power, 165 lbs (75 kg) load, 77°F (25°C), 60% of max. speed on average on pavement.

* Some of the factors that affect range include: speed, number of starts and stops, ambient temperature, etc.

[2] All KickScooter models could install the second battery. Some of the parameters would change in this case.

	Item	E45	E45D	E45E
Dimensions	Length x Width x Height	45.7 × 16.5 × 46.1 in (116 × 42 × 117 cm)		
	folded: Length x Width x Height	46.9 × 16.5 × 14.2 in (119 × 42 × 36 cm)		
Weight	Net Weight	36.2 lbs (16.4 kg)		
	Payload	55–220 lbs (25–100 kg)		
Rider	Recommended Age	14+ years		
	Required Height	3'11"–6'6" (120–200 cm)		
Parameters	Max. Speed	18.6 mph (30 km/h)	12.4 mph (20 km/h)	15.5 mph (25 km/h)
	Typical Range ^[1]	28.0 miles (45 km)		
	Max. Slope	20%		
	Traversable Terrain	asphalt/flat pavement; obstacles < 0.4 in (1 cm); gaps < 1.2 in (3 cm)		
	Operating Temperature	14–104°F (-10–40°C)		
	Storage Temperature	-4–122°F (-20–50°C)		
	IP Rating	IPX4		
	Duration of Charging	Approx. 7.5 h		
Battery	Nominal Voltage	36 V ===		
	Max. Charging Voltage	42 V ===		
	Nominal Energy	368 Wh		
	Nominal Capacity	10.2 Ah		
	Battery Management System	Over-heating, short circuit, over-current, over-discharge and over-charge protection		
	Number of Batteries	2		
Motor	Nominal Power	300 W, 0.3 kW		
	Output Power	71 W, 0.071 kW		
Charger	Input Voltage	100–240 V~		
	Output Voltage	42 V ===		
	Output Current	1.7 A		
Features	Brake Light	LED rear light		
	Shock Absorber	Front		
	Riding Modes	Speed limit mode, Standard mode and Sport mode		
	Ambient light	Customizable colour	/	Customizable colour
Tire	Tires	Dual Density Tires. Material: synthetic rubber. Size: 9 inches		

[1] Typical Range: tested while riding under full power, 165 lbs (75 kg) load, 77°F (25°C), 60% of max. speed on average on pavement.

* Some of the factors that affect range include: speed, number of starts and stops, ambient temperature, etc.

13 Certifications

For Model: E22, E25A, E45

This product is certified to ANSI/CAN/UL-2272 by CSA.
The battery complies with UN/DOT 38.3.

Federal Communications Commission (FCC) Compliance Statement for USA

This device complies with part 15 of the FCC rules. Operation is subject to the following two conditions: (1) This device may not cause harmful interference, and (2) this device must accept any interference received, including interference that may cause undesired operation.

This equipment has been tested and found to comply with the limits for a Class B digital device, pursuant to part 15 of the FCC Rules. These limits are designed to provide reasonable protection against harmful interference in a residential installation. This equipment generates, uses and can radiate radio frequency energy and, if not installed and used in accordance with the instructions, may cause harmful interference to radio communications. However, there is no guarantee that interference will not occur in a particular installation. If this equipment does cause harmful interference to radio or television reception, which can be determined by turning the equipment off and on, the user is encouraged to try to correct the interference by one or more of the following measures:

- Reorient or relocate the receiving antenna.
- Increase the separation between the equipment and receiver.
- Connect the equipment into an outlet on a circuit different from that to which the receiver is connected.
- Consult the dealer or an experienced radio/TV technician for help.

This equipment complies with FCC radiation exposure limits set forth for an uncontrolled environment.

Industry Canada (IC) Compliance Statement for Canada

This device complies with Industry Canada license-exempt RSS standard (s). Operation is subject to the following two conditions: (1) this device may not cause interference, and (2) this device must accept any interference, including interference that may cause undesired operation of the device.

CAN ICES-3 (B)/NMB-3(B)

Neither Segway Inc. nor Ninebot is responsible for any changes or modifications not expressly approved by Segway Inc. or Ninebot. Such modifications could void the user's authority to operate the equipment.

E22	FCC ID: 2ALS8-NT9529 IC: 22636-NT9529
-----	--

E25A	FCC ID: 2ALS8-KS0003 IC: 22636-KS0003
------	--

E45	FCC ID: 2ALS8-KS0001 IC: 22636-KS0001
-----	--

For Model: E22D, E22E, E25D, E25E, E45D, E45E

This product is certified to ANSI/CAN/UL-2272 by CSA.
The battery complies with UN/DOT 38.3.

European Union Compliance Statement Important WEEE information



WEEE Disposal and Recycling Information Correct Disposal of this product. This marking indicates that this product should not be disposed with other household wastes throughout the EU.

To prevent possible harm to the environment or human health from uncontrolled waste disposal, recycle it responsibly to promote the sustainable reuse of materials resources. To return your used device, please use the return and collection systems or contact the retailer where the product was purchased. They can take this product for environmental safe recycling.

Battery recycling information for the European Union



Batteries or packaging for batteries are labeled in accordance with European Directive 2006/66/EC and amendment 2013/56/EU concerning batteries and accumulators and waste batteries and accumulators. The Directive determines the framework for the return and recycling of used batteries and accumulators as applicable throughout the European Union. This label is applied to various batteries to indicate that the battery is not to be thrown away, but rather reclaimed upon end of life per this Directive.

In accordance with the European Directive 2006/66/EC and amendment 2013/56/EU, batteries and accumulators are labeled to indicate that they are to be collected separately and recycled at end of life. The label on the battery may also include a chemical symbol for the metal concerned in the battery (Pb for lead, Hg for mercury, and Cd for cadmium). Users of batteries and accumulators must not dispose of batteries and accumulators as unsorted municipal waste, but use the collection framework available to customers for the return, recycling, and treatment of batteries and accumulators. Customer participation is important to minimize any potential effects of batteries and accumulators on the environment and human health due to the potential presence of hazardous substances.

Before placing electrical and electronic equipment (EEE) in the waste collection stream or in waste collection facilities, the end user of equipment containing batteries and/or accumulators must remove those batteries and accumulators for separate collection.

Restriction of Hazardous Substances (RoHS) Directive

This Ninebot (Changzhou) Tech Co., Ltd. product, with included parts (cables, cords, and so on) meets the requirements of Directive 2011/65/EU on the restriction of the use of certain hazardous substances in electrical and electronic equipment ("RoHS recast" or "RoHS 2").

Radio Equipment Directive

The company "Segway Europe BV" hereby declares that this device complies with the essential requirements and other relevant provisions of the RED directive 2014/53/EU, the machine directive 2006/42/EC and the RoHS directive 2011/65/EU.

The declaration of conformity can be viewed at the following address: <http://eu-en.segway.com/support-instructions>



Segway Europe B.V.

EU Contact Address for regulatory topics only: Hogehilweg 8, 1101CC Amsterdam, The Netherlands.

Hereby, Ninebot (Changzhou) Tech Co., Ltd, declares that the wireless equipment listed in this section are in compliance with the essential requirements and other relevant provisions of Directive 2014/53/EU.

Bluetooth	Frequency Band(s)	2.4000-2.4835GHz
	Max. RF Power	100mW

14 Trademark and Legal Statement

Ninebot is the registered trademark of Ninebot (Tianjin) Tech. Co., Ltd; Segway and the Rider Design are the registered trademarks of Segway Inc.; Android, Google Play are trademarks of Google Inc., App Store is a service mark of Apple Inc., The respective owners reserve the rights of their trademarks referred to in this manual.

The KickScooter is covered by relevant patents. For patent information go to <http://www.segway.com>.

We have attempted to include descriptions and instructions for all the functions of the KickScooter at the time of printing. However, due to constant improvement of product features and changes of design, your KickScooter may differ slightly from the one shown in this document. Visit the Apple App Store (iOS) or the Google Play Store (Android) to download and install the App.

Please note that there are multiple Segway and Ninebot models with different functions, and some of the functions mentioned herein may not be applicable to your unit. The manufacturer reserves the right to change the design and functionality of the KickScooter product and documentation without prior notice.

© 2020 Ninebot (Beijing) Tech Co. Ltd. All rights reserved.

15 Contacts

Contact us if you experience issues relating to riding, maintenance and safety, or errors/faults with your KickScooter.

Americas:

Segway Inc.

14 Technology Drive, Bedford, NH 03110, USA

Tel: 1-603-222-6000

Fax: 1-603-222-6001

Toll Free: 1-866-473-4929

E-mail Sales: customeroperation@segway.com

E-mail Service: technicalsupport@segway.com

Website: www.segway.com

Europe, Middle East and Africa:

Segway Europe B.V.

Hogehilweg 8, 1101CC Amsterdam, The Netherlands

Website: www.segway.com

Have your KickScooter serial number on hand when contacting Segway.

You can find your serial number on the underside of your KickScooter or Basic Information in the Segway-Ninebot App.