



FRESH 'N REBEL

PRODUCT NUMBER:
3HP4500 v1 001

CLAM ELITE
QUICK START MANUAL

Hereby, Sitecom declares that this radio equipment is in compliance with Directive 2014/53/EU.
The full text of the EU declaration of conformity is available at the following internet address: www.freshnrebel.com
Operating frequency band: 2400 to 2483.5 MHz. Maximum radio-frequency power transmitted: 6.52 dBm / 4.49 mW

Sitecom verklaart hierbij dat dit radioapparaat voldoet aan de richtlijn 2014/53/EU.
De volledige tekst van de EG-verklaring van overeenstemming is beschikbaar op: www.freshnrebel.com
Gebruikte frequentieband: 2400 tot 2483.5 MHz. Maximaal uitgezonden radiofrequentievermogen: 6.52 dBm / 4.49 mW

Hiermit erklärt Sitecom, dass der Funkanlagentyp der Richtlinie 2014/53/EU entspricht.
Der vollständige Text der EU-Konformitätserklärung ist unter der folgenden Internetadresse verfügbar: www.freshnrebel.com
Betriebsfrequenzband: 2400 bis 2483.5 MHz. Maximale übertragene HF-Leistung: 6.52 dBm / 4.49 mW

Sitecom dichiara che questa apparecchiatura radio è conforme alla Direttiva 2014/53/UE.
Il testo completo della dichiarazione di conformità UE è disponibile al seguente indirizzo Internet: www.freshnrebel.com
Banda di frequenza di funzionamento: da 2400 a 2483.5 MHz. Potenza massima delle frequenze radio trasmesse: 6.52 dBm / 4.49 mW

Por la presente, Sitecom declara que este equipo de radio cumple con la normativa europea 2014/53/EU.
El texto completo de la declaración UE de conformidad está disponible en la siguiente dirección de internet: www.freshnrebel.com
Banda de frecuencia de funcionamiento: 2400 a 2483.5 MHz. Potencia de radiofrecuencia máxima transmitida: 6.52 dBm / 4.49 mW

A Sitecom vem por este meio declarar que este equipamento de rádio cumpre o disposto na Diretiva 2014/53/UE.
A versão integral da declaração de conformidade da UE está disponível na internet no seguinte endereço: www.freshnrebel.com
Banda de frequência de funcionamento: 2400 a 2483.5 MHz. Potência de radiofrequência máxima transmitida: 6.52 dBm / 4.49 mW

Sitecom déclare par la présente que cet équipement radioélectrique est en conformité avec la Directive 2014/53/UE.
Le texte intégral de la déclaration de conformité de l'UE est disponible à l'adresse internet suivante : www.freshnrebel.com
Bande de fréquences opérationnelle : 2400 à 2483.5 MHz. Puissance fréquence radio maximale transmise : 6.52 dBm / 4.49 mW

Firma Sitecom niniejszym oświadcza, że urządzenie radiowe spełnia wymagania dyrektywy 2014/53/UE.
Pełny tekst deklaracji zgodności UE dostępny jest pod adresem internetowym: www.freshnrebel.com
Pasma częstotliwości pracy: 2400 do 2483.5 MHz. Maksymalna moc nadawanego sygnału radiowego: 6.52 dBm / 4.49 mW

Prin prezenta, Sitecom declară că acest echipament radio este în conformitate cu prevederile Directivei 53/2014/UE.
Textul complet al declarației de conformitate UE este disponibil la următoarea adresă de internet: www.freshnrebel.com
Bandă de frecvență de funcționare: 2400 - 2483.5 MHz. Putere maximă de frecvență radio transmisă: 6.52 dBm / 4.49 mW

Με το παρόν, η Sitecom δηλώνει ότι αυτός ο ραδιοεξοπλισμός συμμορφώνεται με την Οδηγία 2014/53/Ε.
Το πλήρες κείμενο της δήλωσης συμμόρφωσης για την ΕΕ διατίθεται στην ακόλουθη διεύθυνση Internet: www.freshnrebel.com
Ζώνη συχνοτήτων λειτουργίας: 2400 έως 2483.5 MHz. Μέγιστη ισχύς μετάδοσης ραδιοσυχνότητας: 6.52 dBm / 4.49 mW

Sitecom настоящим заявляет, что этот продукт соответствует Директиве 2014/53 / EU.
Полный текст декларации о соответствии ЕС доступен по следующему интернет-адресу: www.freshnrebel.com
Диапазон рабочих частот: от 2400 до 2483,5 МГц. Максимальная передаваемая мощность радиочастоты: 6,52 дБм / 4,49 мВт



FRESHREBEL.COM

FIND THE MANUAL IN YOUR OWN LANGUAGE ON OUR WEBSITE

- NL** Vind de handleiding in je eigen taal op onze website
- DE** Auf unserer Website findest du ein Handbuch in deiner Sprache
- IT** Cerca il manuale nella tua lingua sul nostro sito Web
- ES** En nuestro sitio web podrás encontrar el manual en tu idioma
- PT** Podes encontrar o manual no teu idioma no nosso site
- FR** Retrouve le mode d'emploi dans ta propre langue sur notre site web
- PL** Instrukcję w swoim języku znajdziesz na naszej stronie
- RO** Găsiți manualul în limba dvs. pe website-ul nostru
- GR** Βρείτε το εγχειρίδιο στη γλώσσα σας στην τοποθεσία μας στο Web
- RU** Найдите руководство на вашем родном языке на нашем сайте

BUTTONS

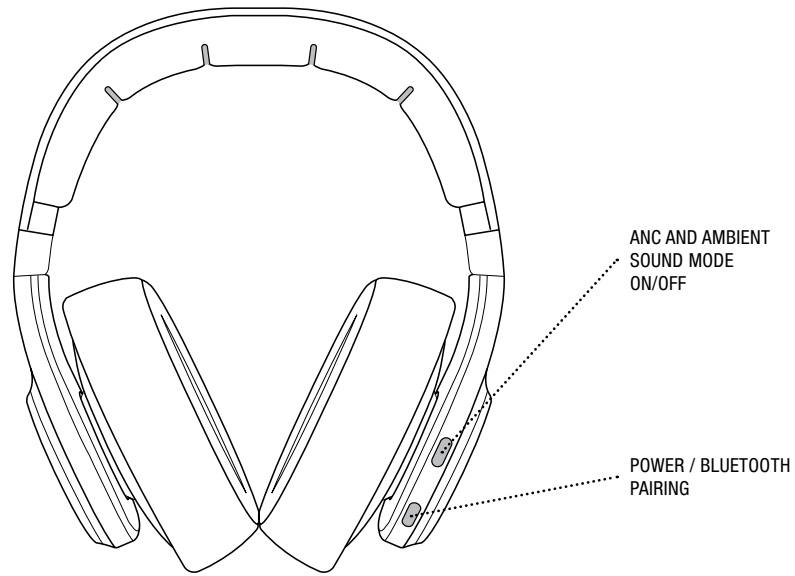

LEDS

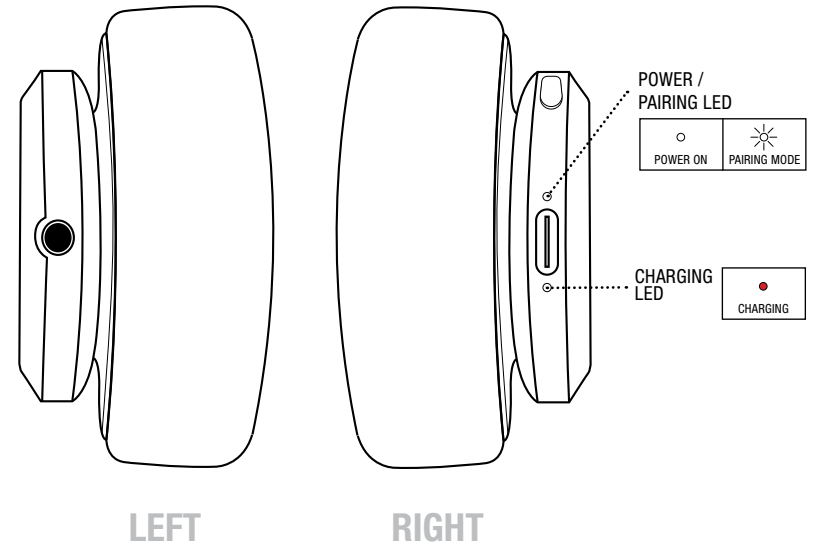

GETTING STARTED

1.

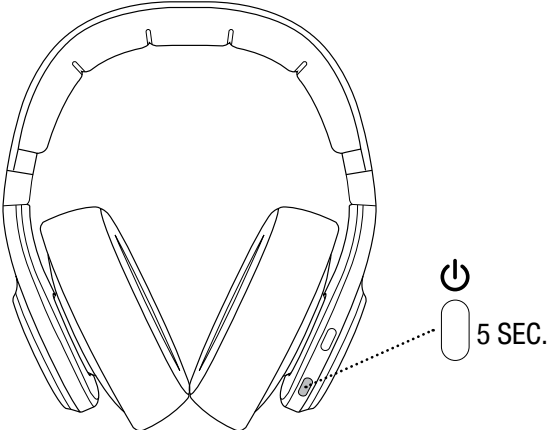

3.

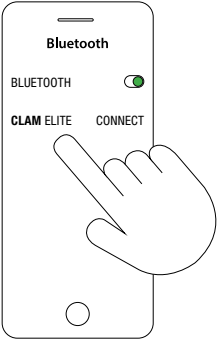

2.

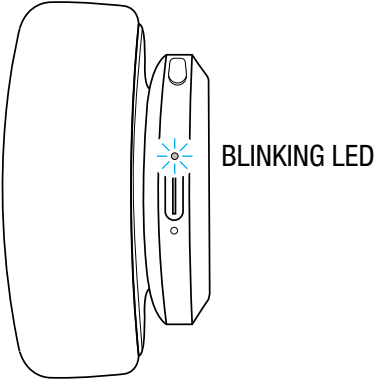

4.

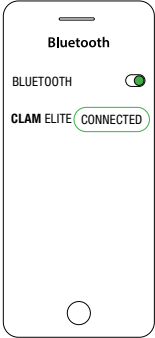

OPERATION

GENERAL USE - OPERATING ANC

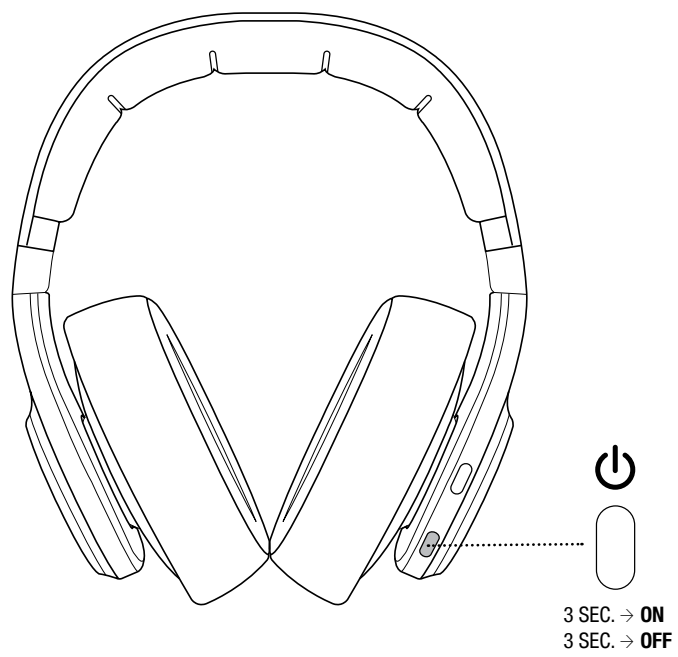
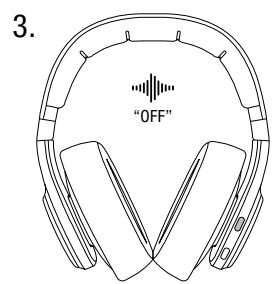
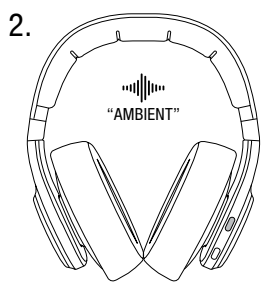
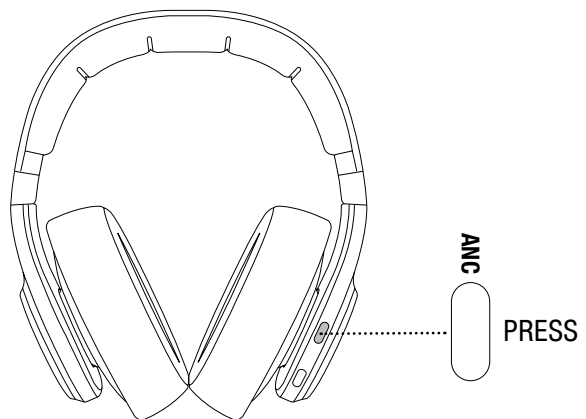

MUSIC & PHONE CALLS

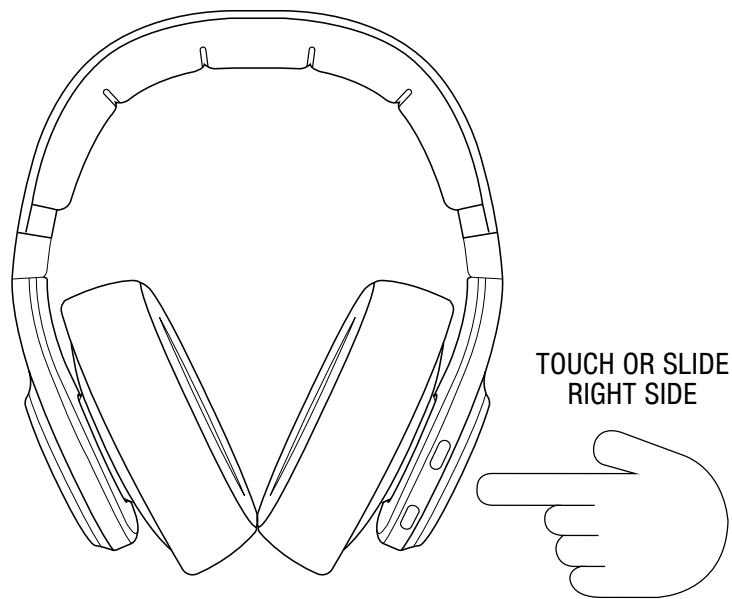

MUSIC

PHONE CALLS

VOICE ASSISTANT

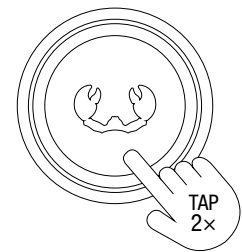

PLAY / PAUSE

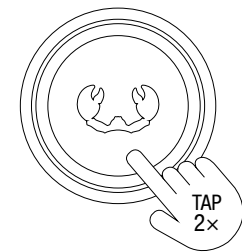

TAKE CALL



VOICE ASSISTANT

VOLUME UP

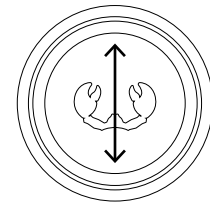

VOLUME DOWN

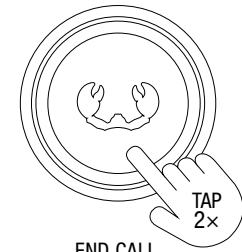

END CALL

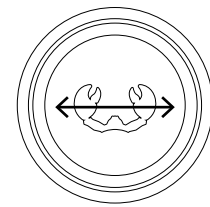

PREVIOUS / NEXT

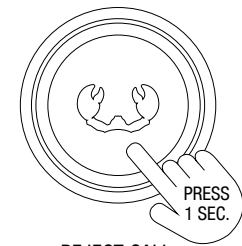

REJECT CALL

KNOPPEN

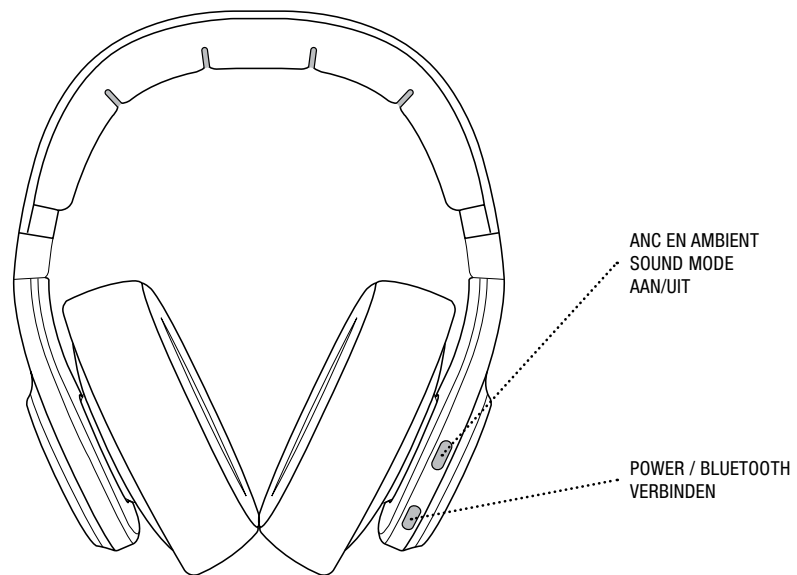

LEDS

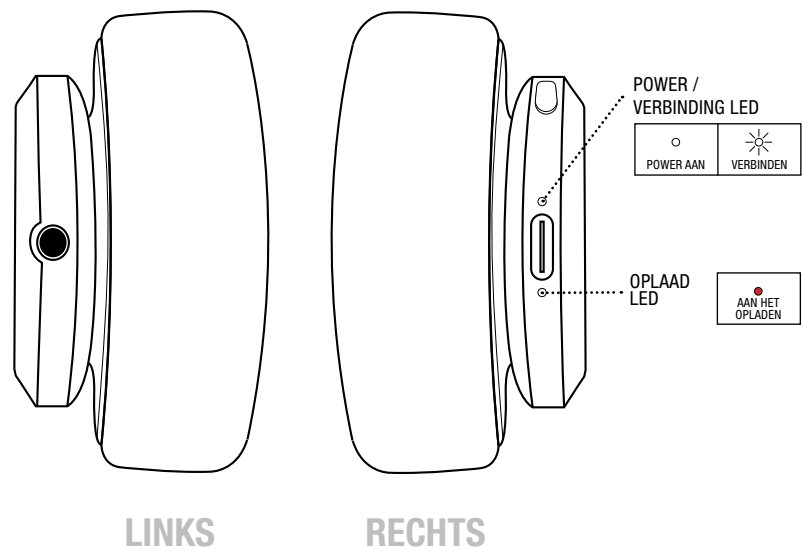

AAN DE SLAG

1.

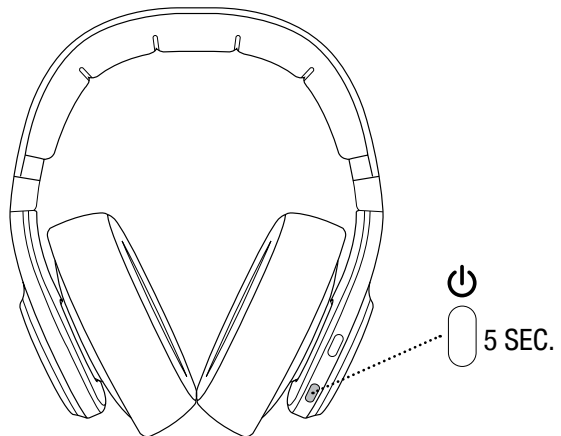

3.

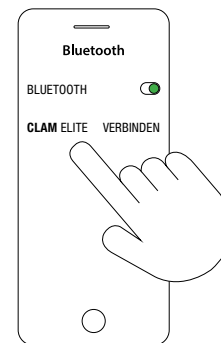

2.

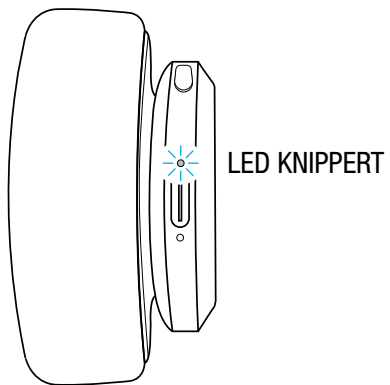

4.

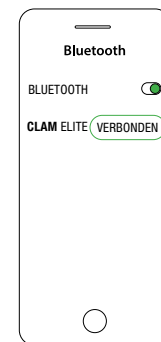

ALGEMEEN - ANC BEDIENEN

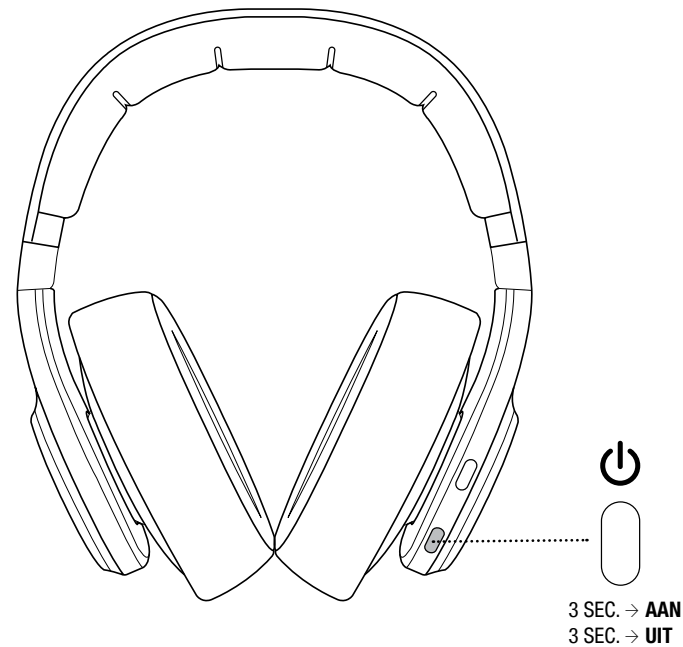
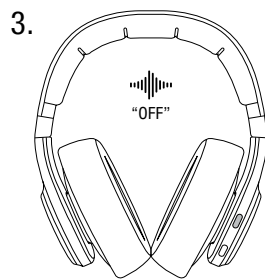
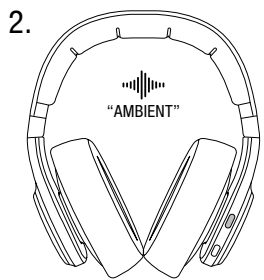
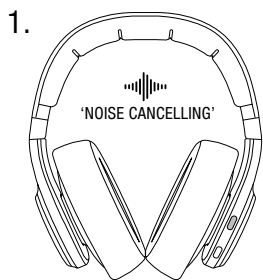
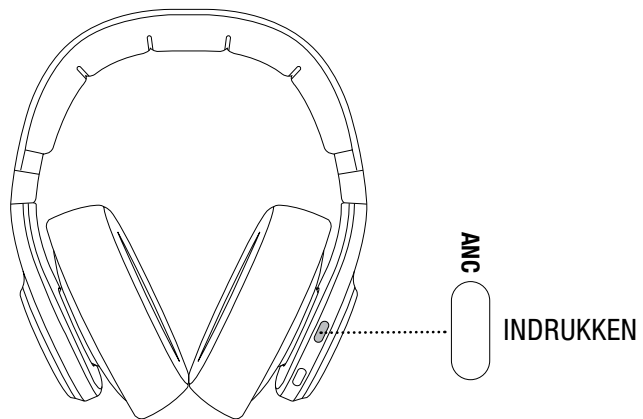

MUZIEK & OPROEPEN

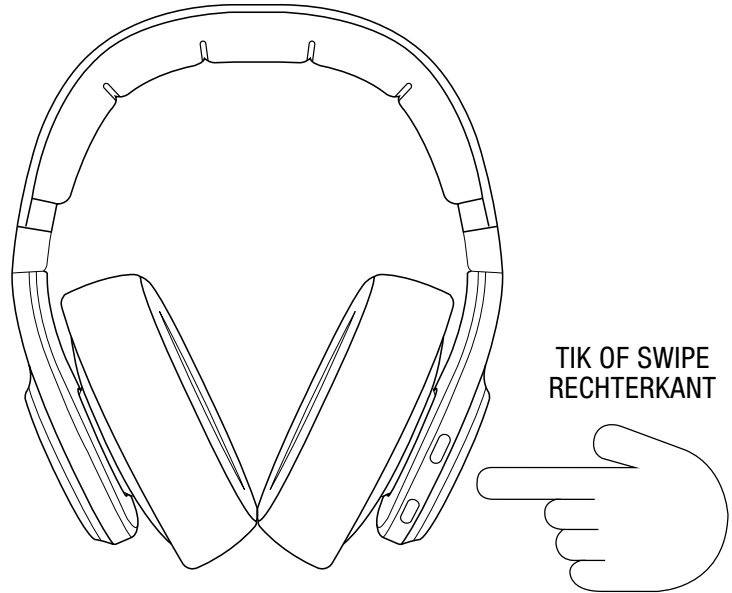

MUZIEK

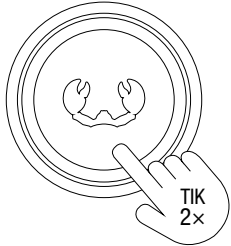

PLAY / PAUZE

VOLUME OMHOOG

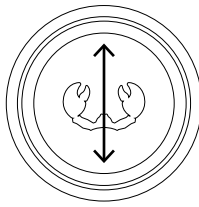

VOLUME OMLAAG

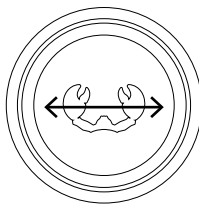

VORIGE / VOLGENDE

OPROEPEN

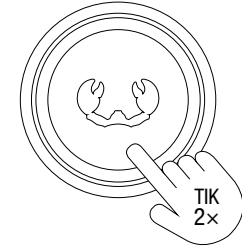

OPROEP BEANTWOORDEN

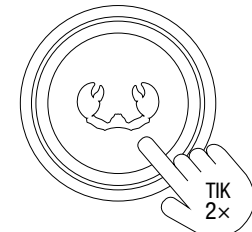

OPROEP BEËNDIGEN

SPRAAKASSISTENT



SPRAAKASSISTENT



OPROEP AFWIJZEN

TASTEN

LEDs

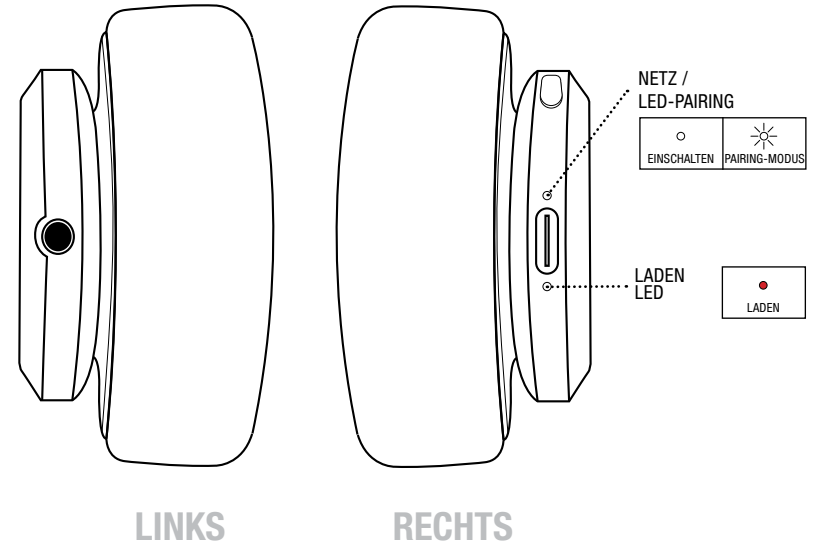
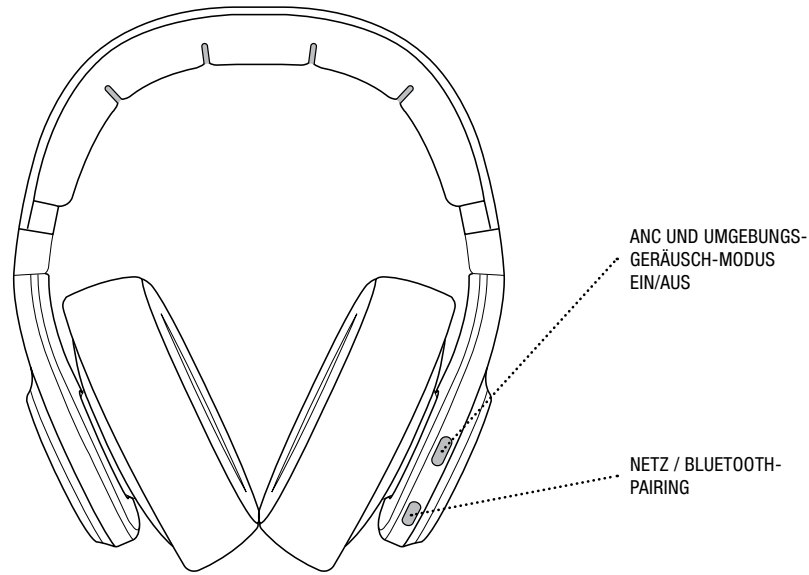

INBETRIEBNAHME

1.

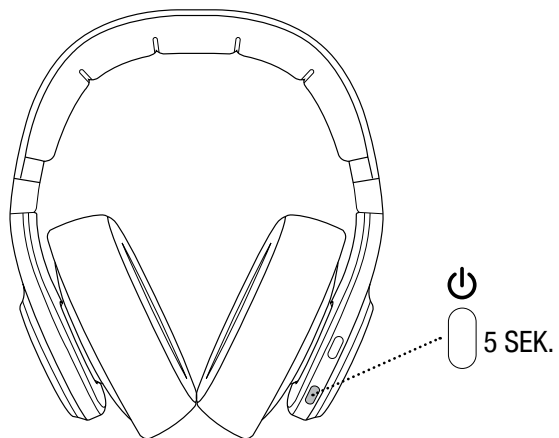

3.

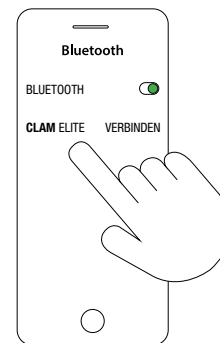

2.

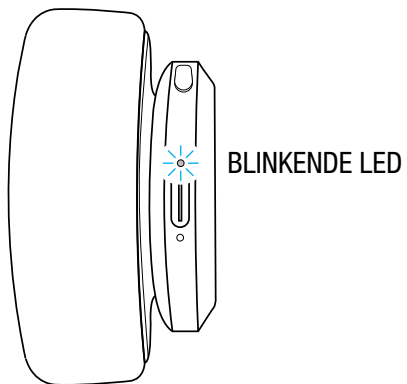

4.



ALLGEMEINE VERWENDUNG — ANC BEDIENEN

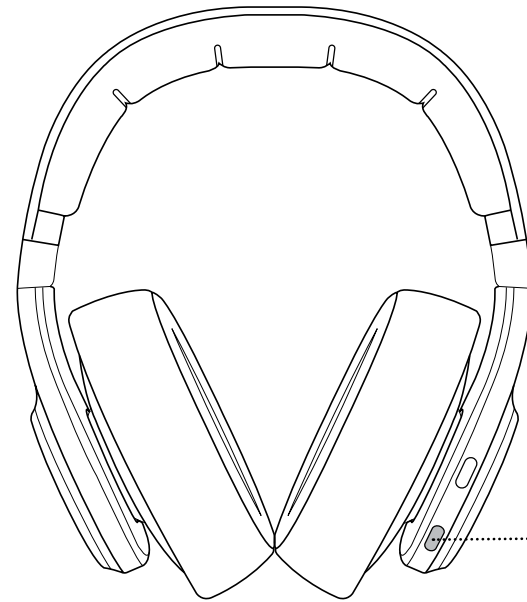
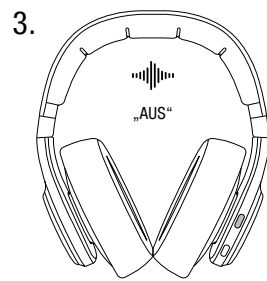
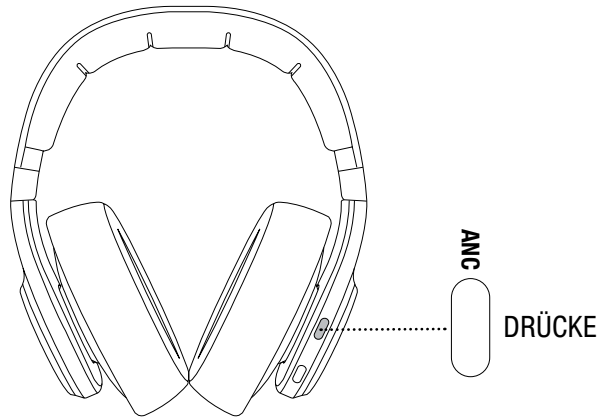

3 SEK. → EIN
3 SEK. → AUS

MUSIK UND TELEFONATE

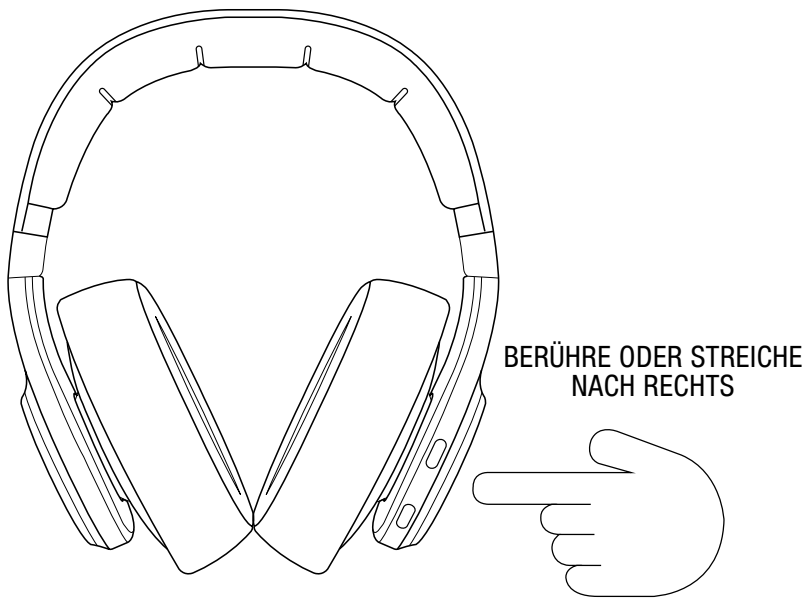

MUSIK

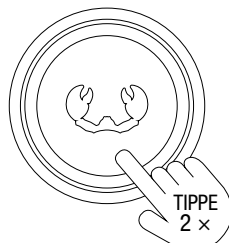

WIEDERGABE / PAUSE

LAUTSTÄRKE ERHÖHEN

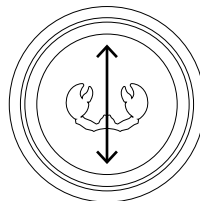

LAUTSTÄRKE REDUZIEREN

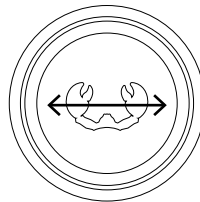

ZURÜCK / WEITER

TELEFONATE

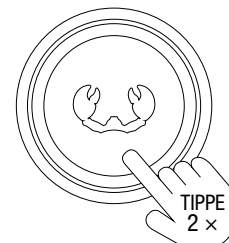

ANRUF ANNEHMEN

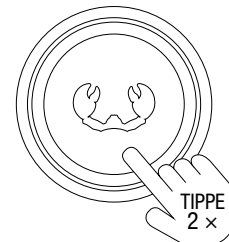

ANRUF BEENDEN

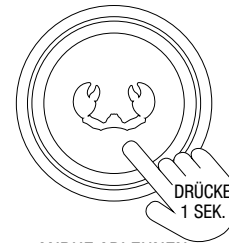

ANRUF ABLEHNEN

SPRACHASSISTENT

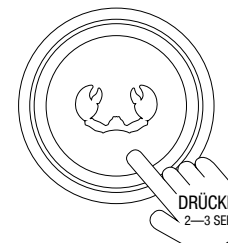

SPRACHASSISTENT

PULSANTI

LED

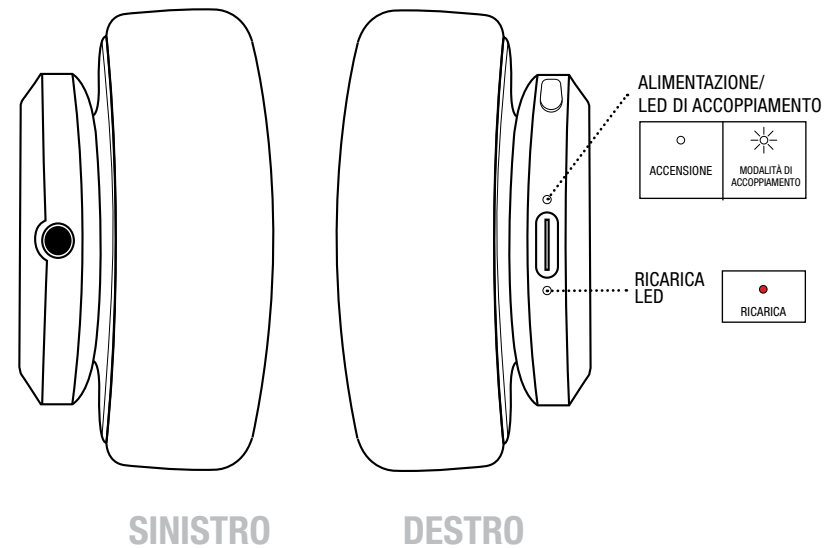
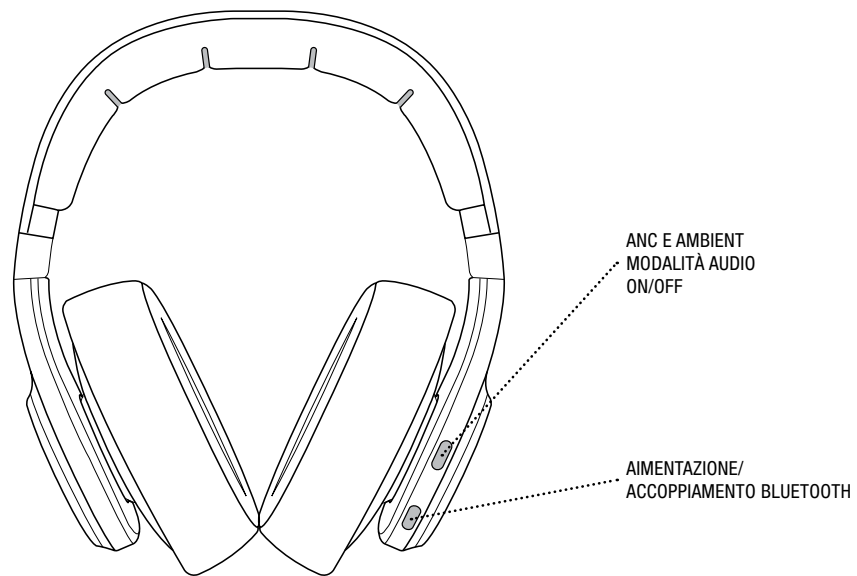

GUIDA INTRODUTTIVA

1.

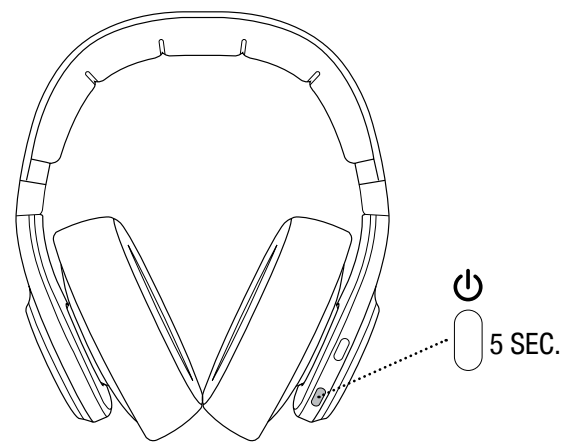

3.

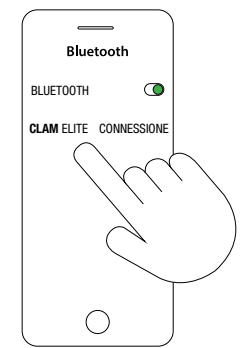

2.

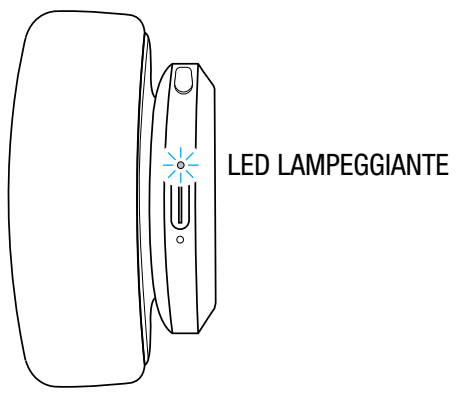

4.

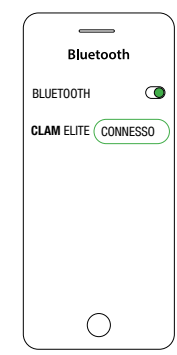

FUNZIONAMENTO

USO GENERALE - FUNZIONAMENTO ANC

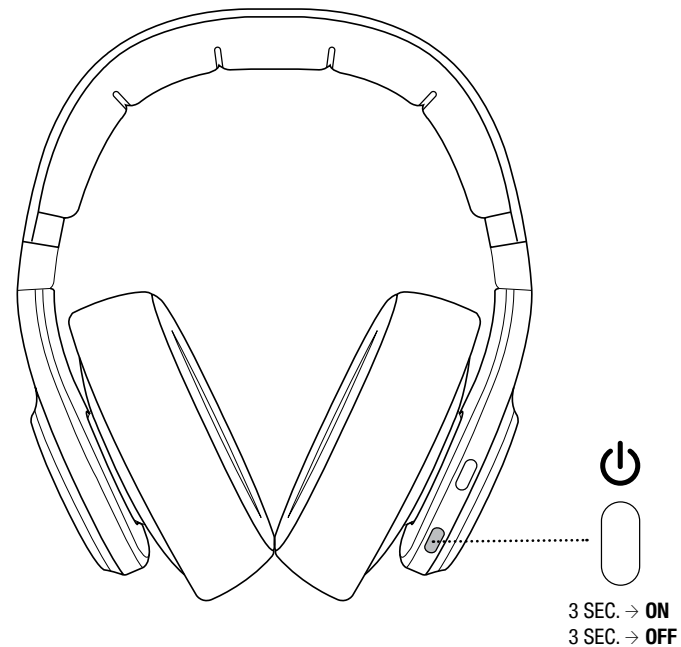
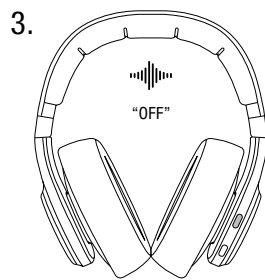
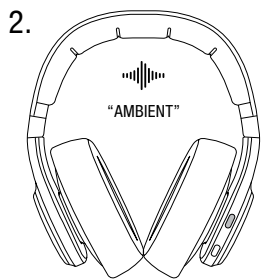
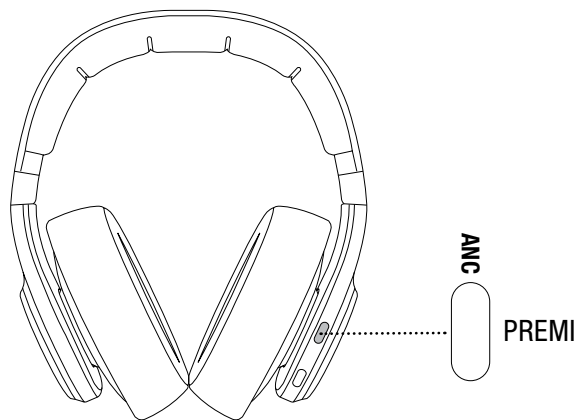

MUSICA E CHIAMATE TELEFONICHE



MUSICA

CHIAMATE TELEFONICHE

ASSISTENTE VOCALE

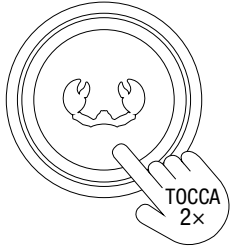

PLAY/PAUSE

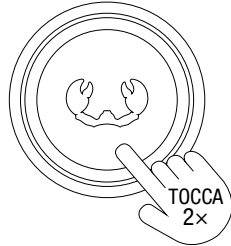

RISPONDI A UNA CHIAMATA

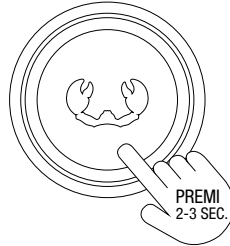

ASSISTENTE VOCALE

AUMENTA IL VOLUME

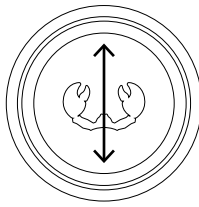

ABBASSA IL VOLUME



METTI FINE ALLA CHIAMATA

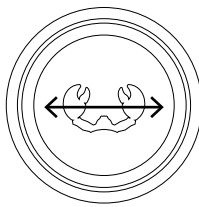

PRECEDENTE/SUCCESSIVO

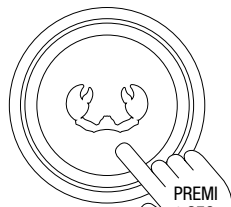

RIFIUTA LA CHIAMATA

BOTONES

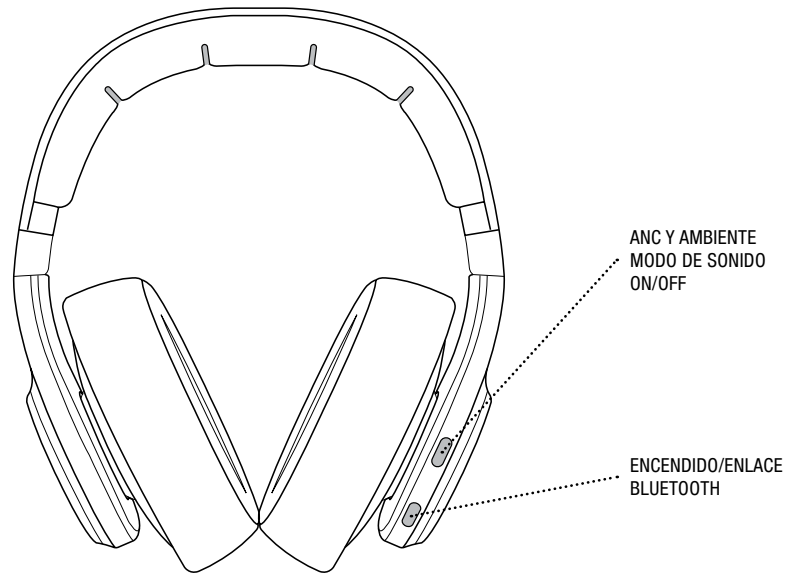

LEDS

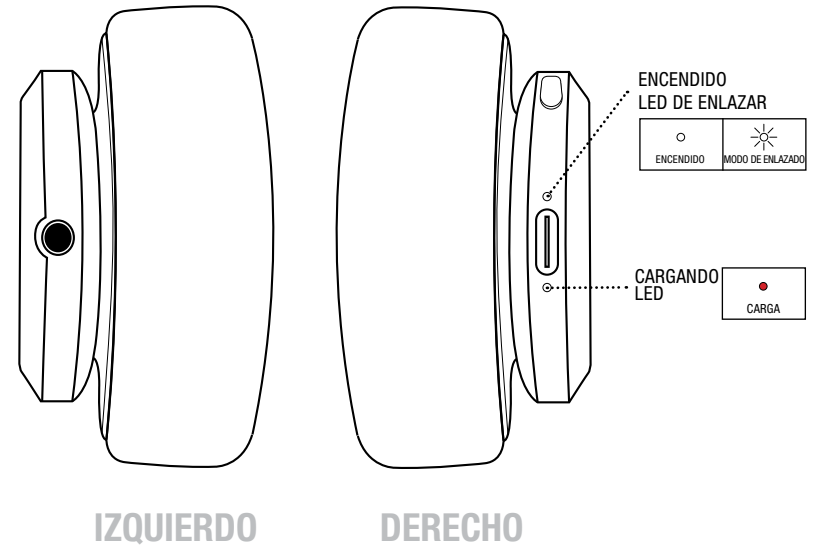

PRIMEROS PASOS

1.

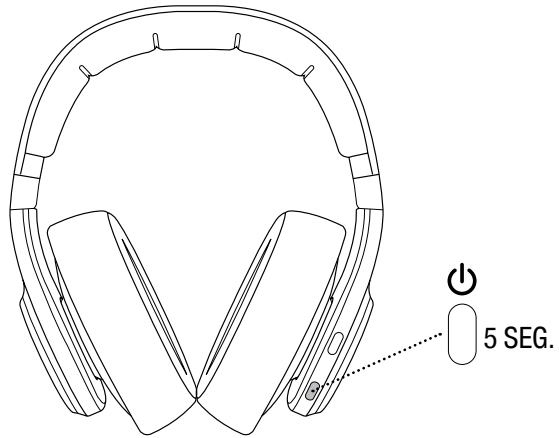

3.

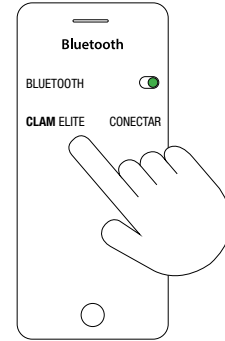

2.

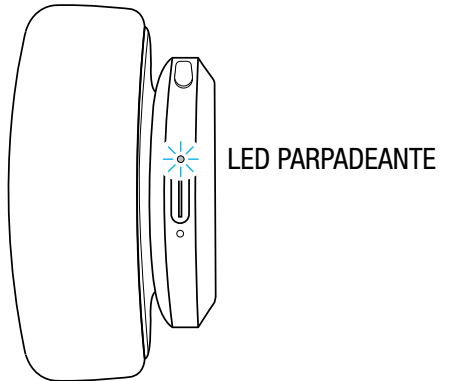

4.



MANEJO

USO GENERAL: FUNCIONAMIENTO DE ANC

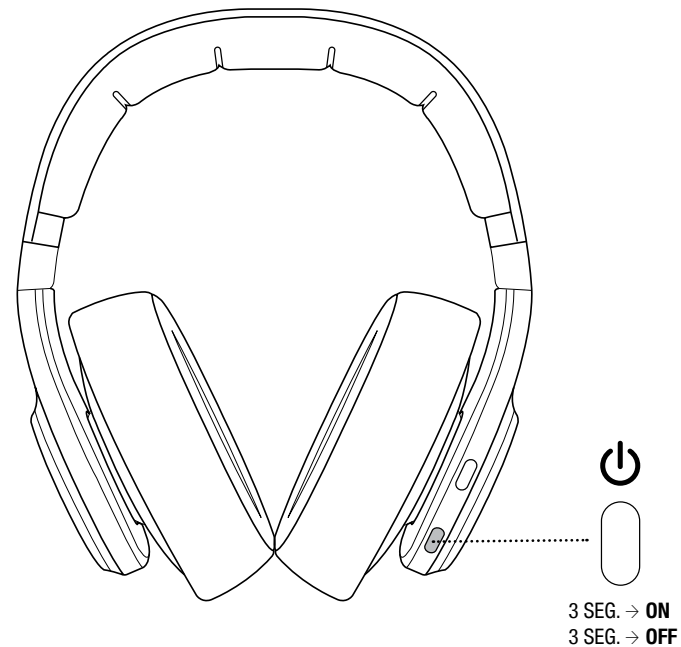
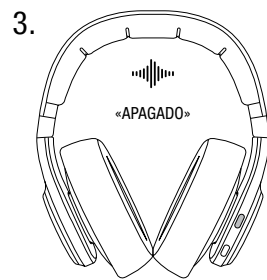
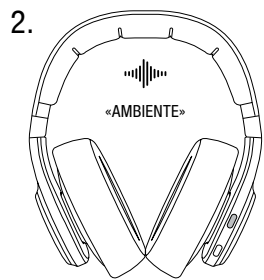
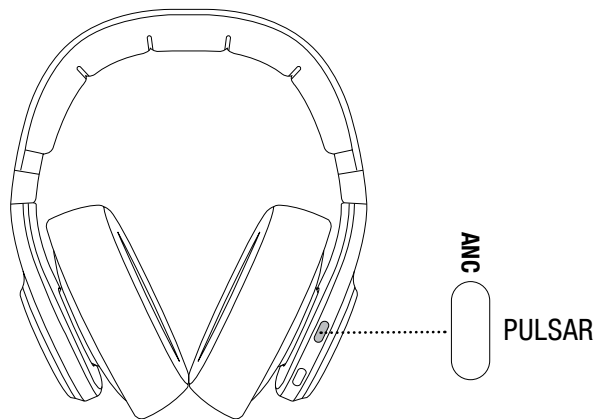

MÚSICA Y LLAMADAS TELEFÓNICAS



MÚSICA

LLAMADAS TELEFÓNICAS

ASISTENTE DE VOZ

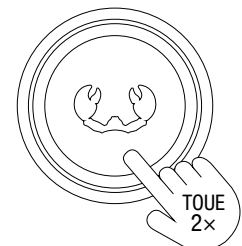

REPRODUCIR/PAUSA

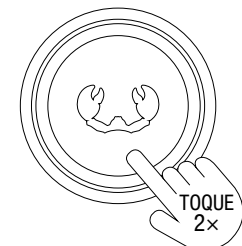

RESPONDER LLAMADA

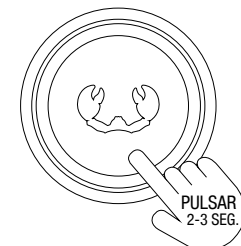

ASISTENTE DE VOZ

SUBIR EL VOLUMEN

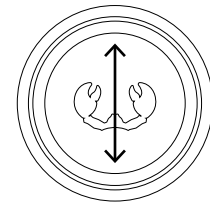

BAJAR VOLUMEN

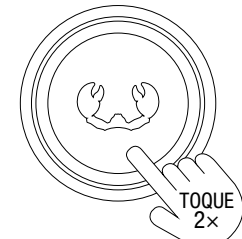

FINALIZAR LLAMADA

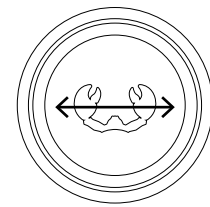

ANTERIOR/SIGUIENTE

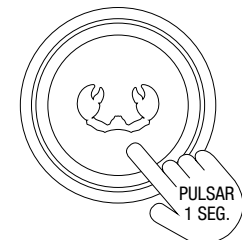

RECHAZAR LLAMADA

BOTÕES

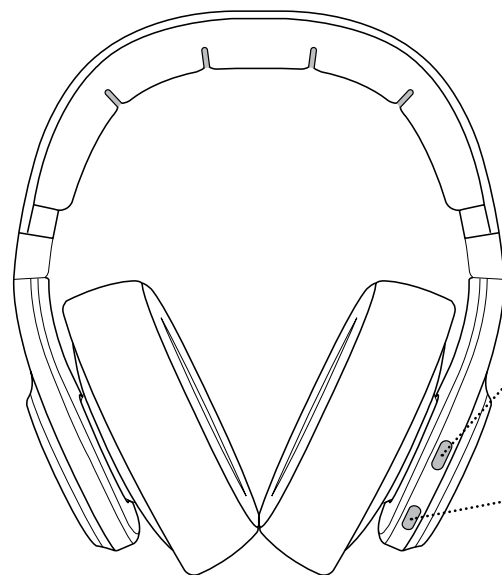

MODO DE SOM
ANC E AMBIENTE
LIGAR/DESLIGAR

ALIMENTAÇÃO /
EMPARELHAMENTO
POR BLUETOOTH

LED

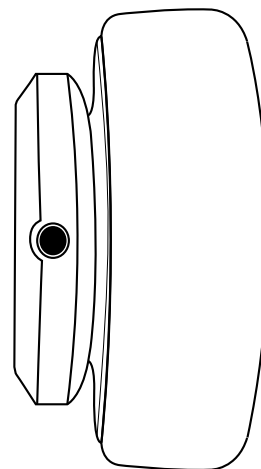

ESQUERDA

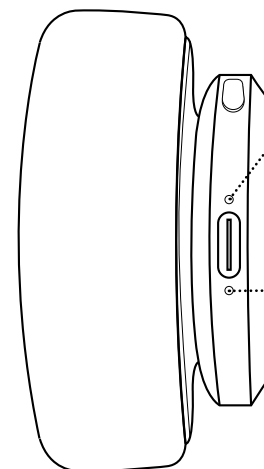

DIREITA

LED DE ALIMENTAÇÃO/
EMPARELHAMENTO

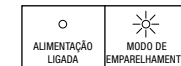

LED DE
CARGA



INTRODUÇÃO

1.

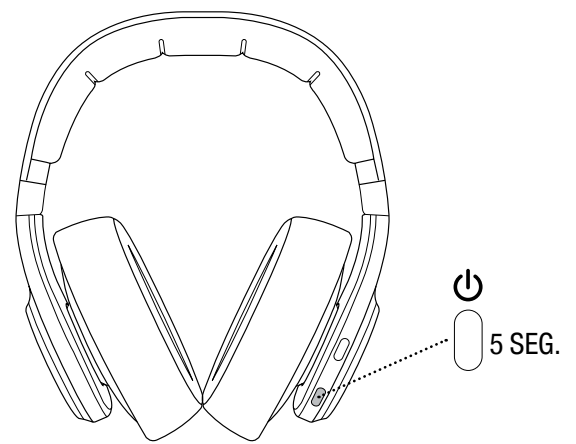

3.

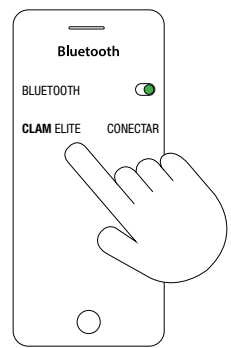

2.

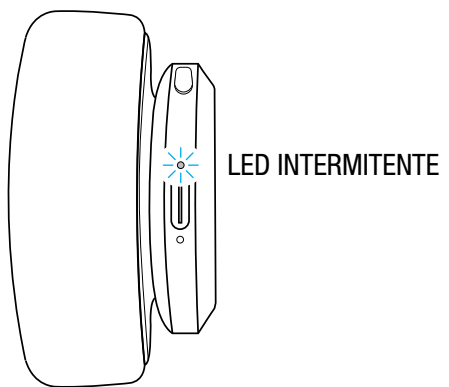

4.



UTILIZAÇÃO

UTILIZAÇÃO GERAL - UTILIZAÇÃO DO ANC

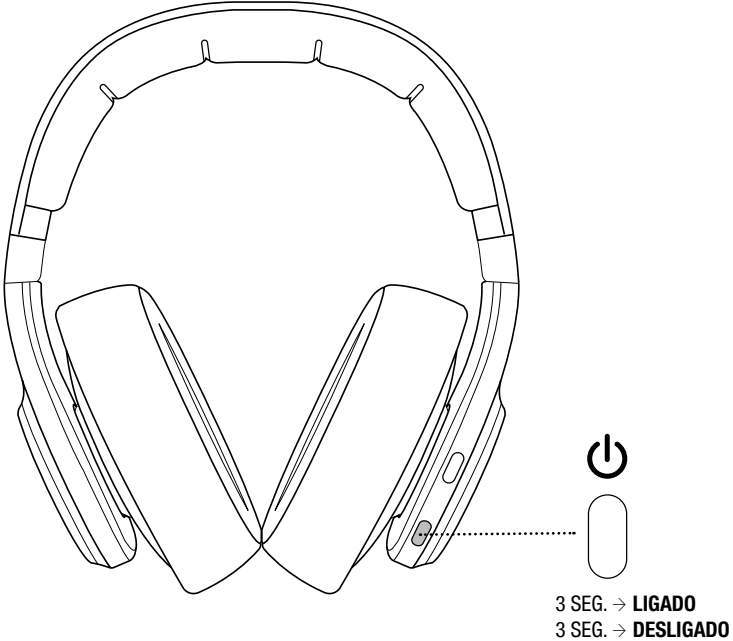
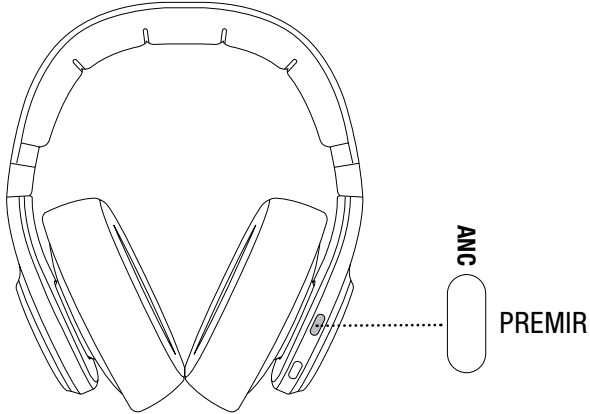

MÚSICA E CHAMADAS TELEFÓNICAS



MÚSICA

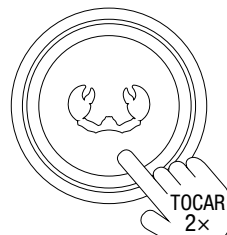

REPRODUZIR / PAUSA

CHAMADAS TELEFÓNICAS

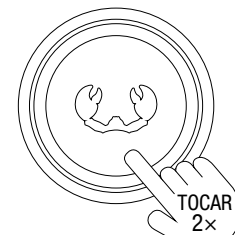

ATENDER CHAMADA

ASSISTENTE DE VOZ

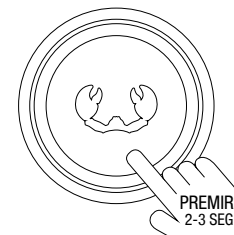

ASSISTENTE DE VOZ

AUMENTAR VOLUME

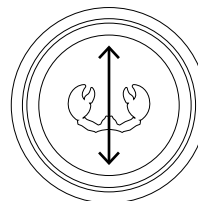

DIMINUIR VOLUME

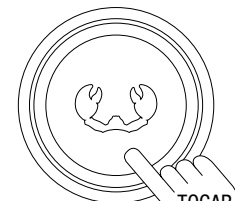

TERMINAR CHAMADA

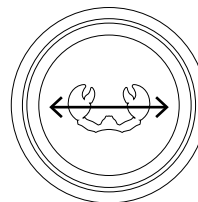

ANTERIOR / SEGUINTE

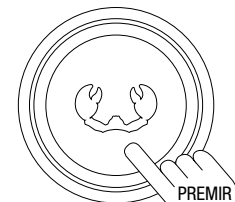

REJEITAR CHAMADA

BOUTONS

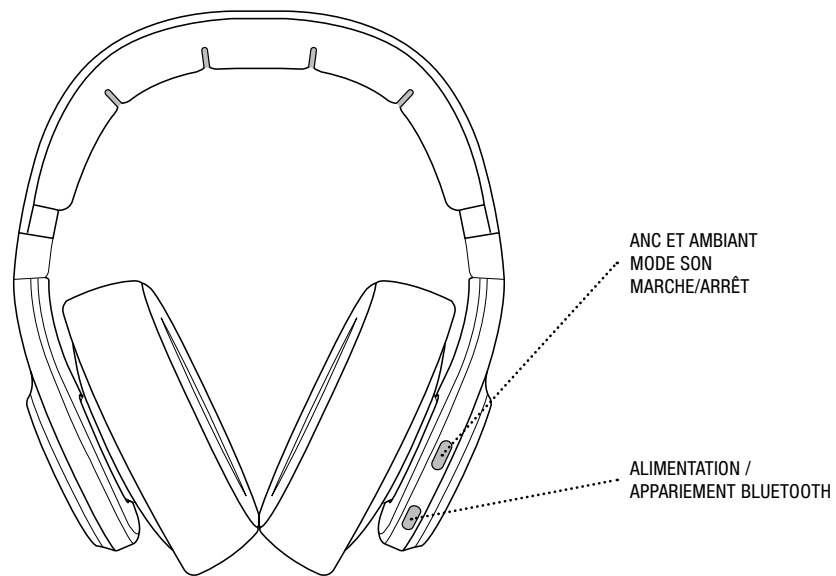

LED

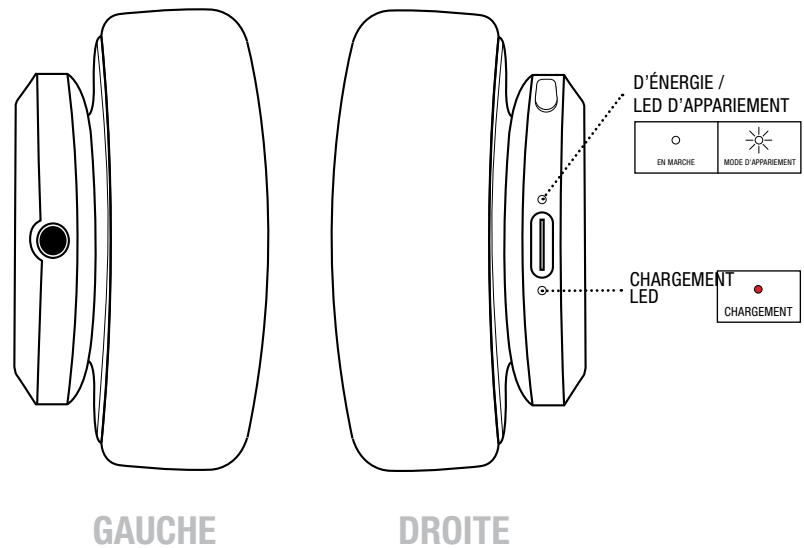

COMMENCER

1.

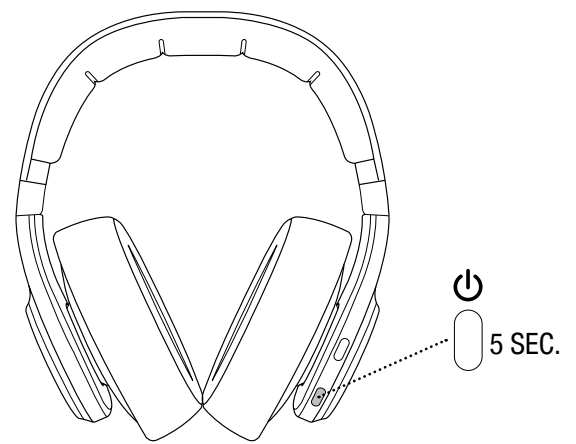

3.

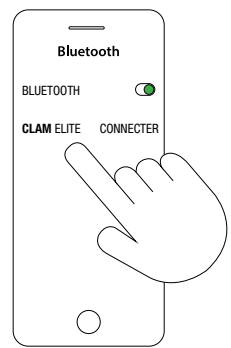

2.

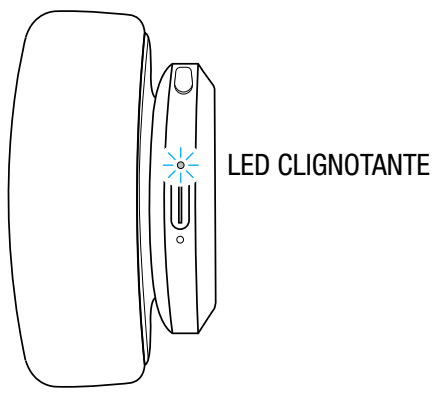

4.

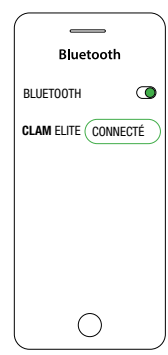

FONCTIONNEMENT

UTILISATION GÉNÉRALE - FONCTIONNEMENT EN MODE ANC

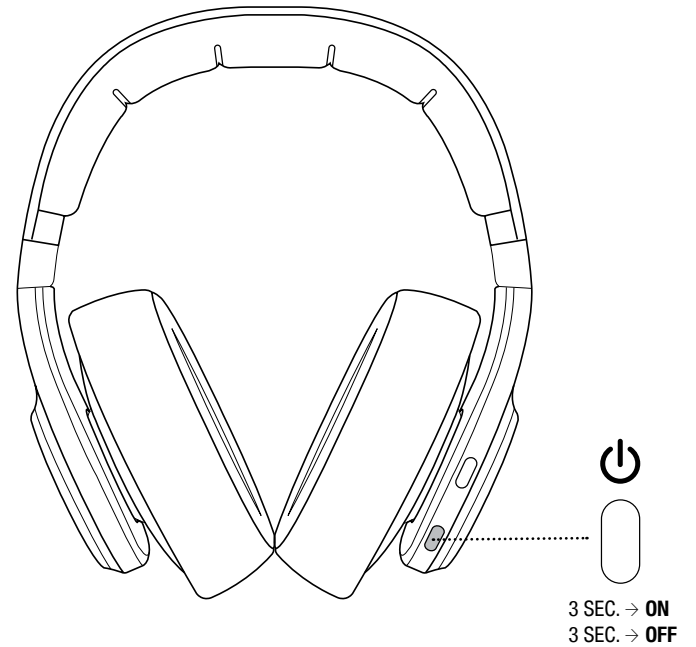
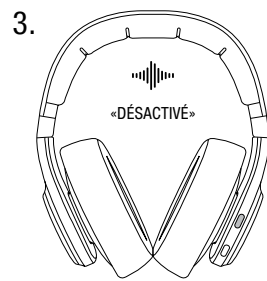
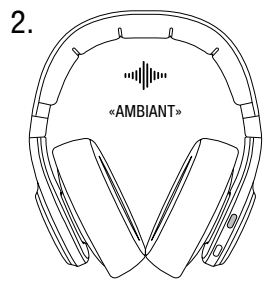
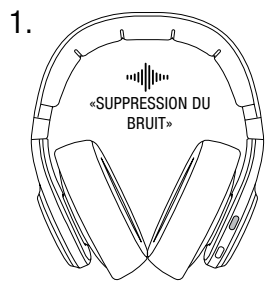
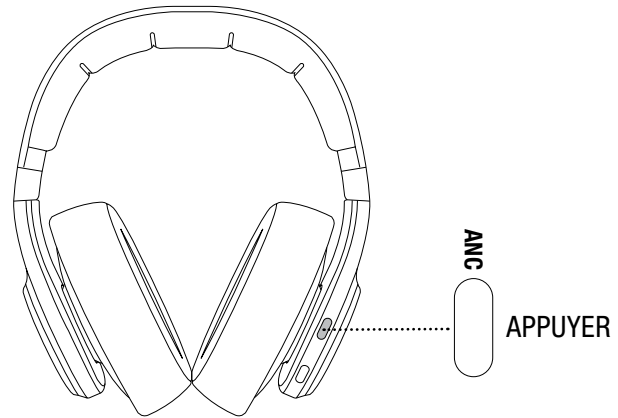

MUSIQUE & APPELS TÉLÉPHONIQUES

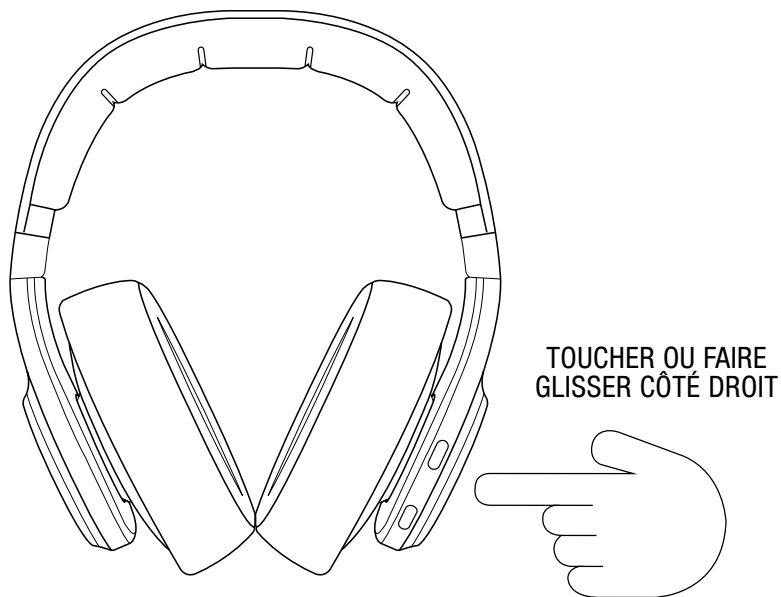

MUSIQUE

APPELS TÉLÉPHONIQUES

ASSISTANT VOCAL

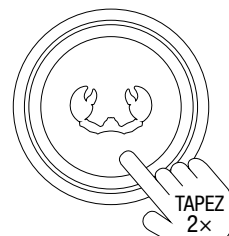

LECTURE / PAUSE

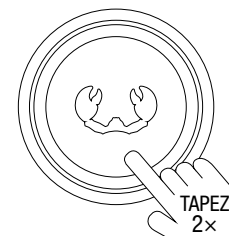

PRENDRE L'APPEL

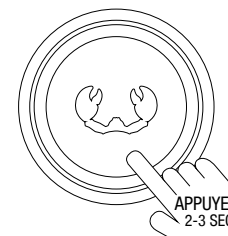

ASSISTANT VOCAL

MONTER LE VOLUME

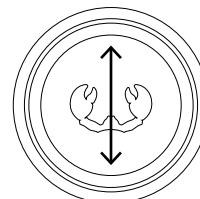

BAISSER LE VOLUME

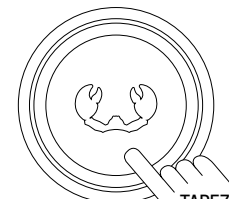

METTRE FIN À L'APPEL

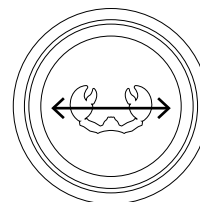

PRÉCÉDENT / SUIVANT

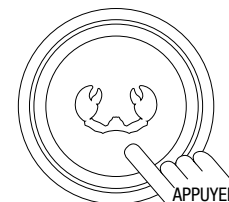

REJETER L'APPEL

PRZYCISKI

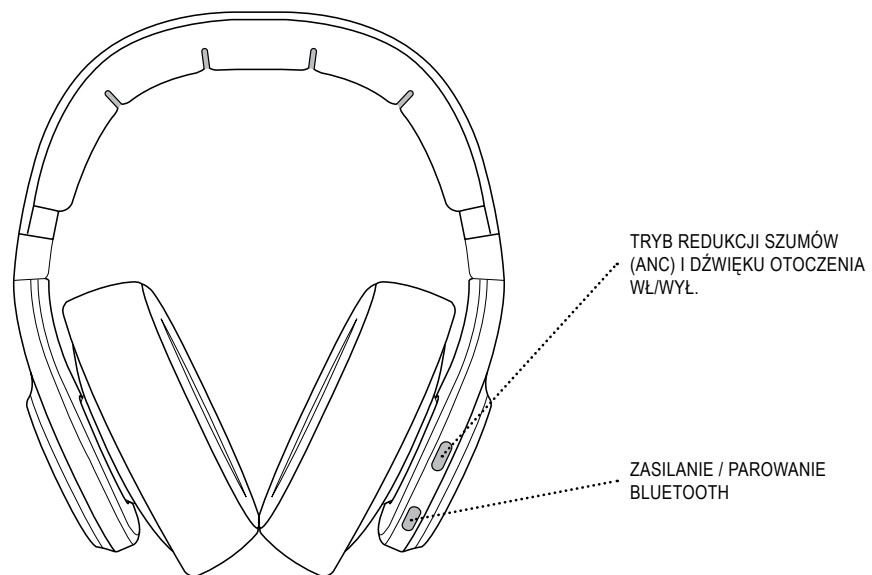

KONTROLKI LED

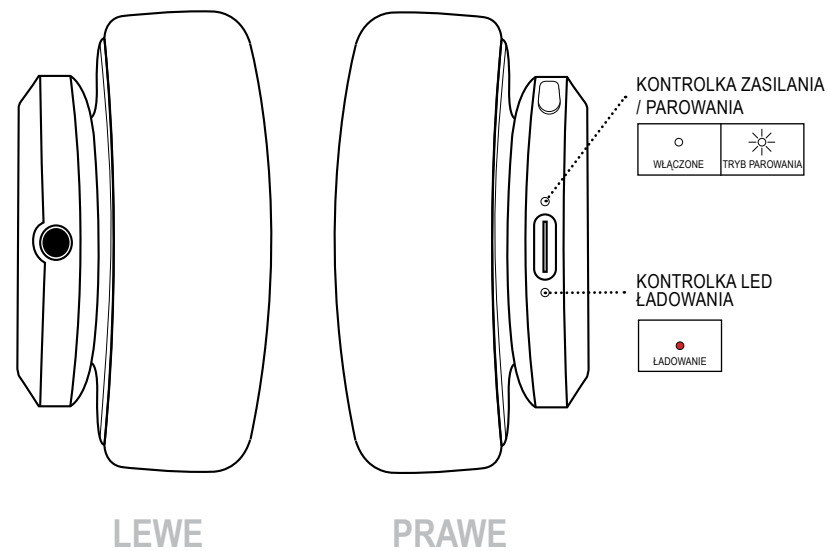

ROZPOCZYNIANIE UŻYTKOWANIA

1.

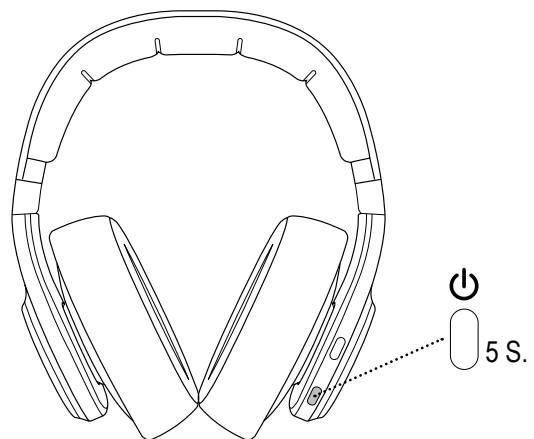

3.

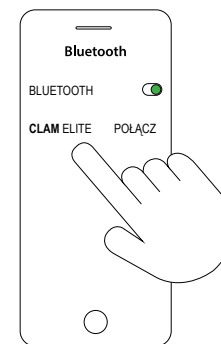

2.

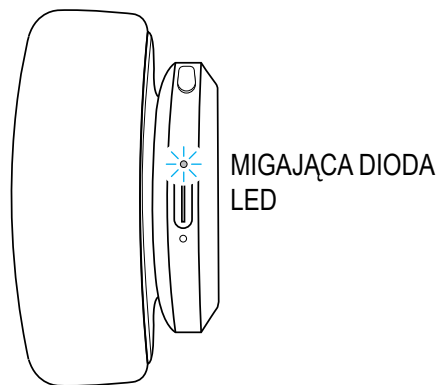

4.

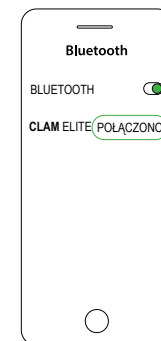

OGÓLNE UŻYTKOWANIE – OBSŁUGA
TRYBU ANC

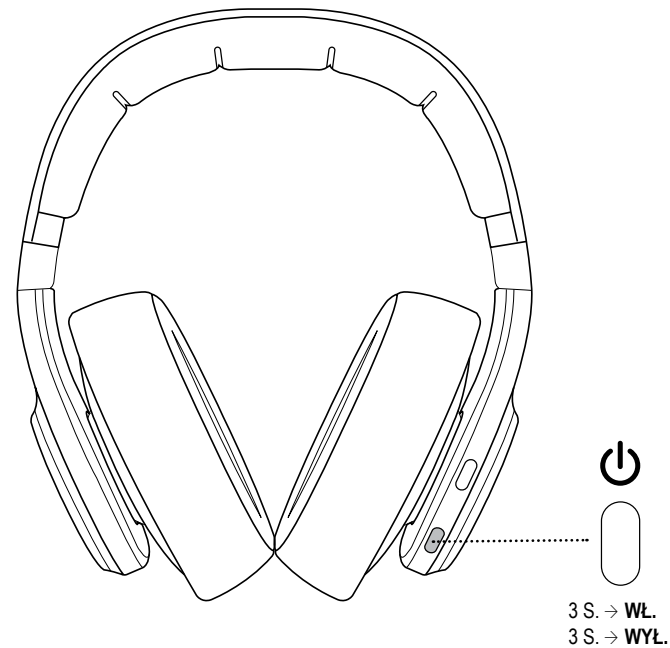
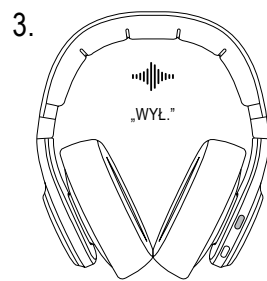
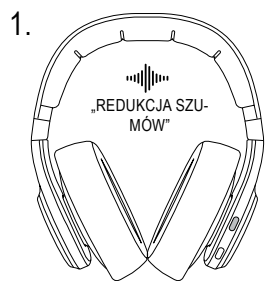
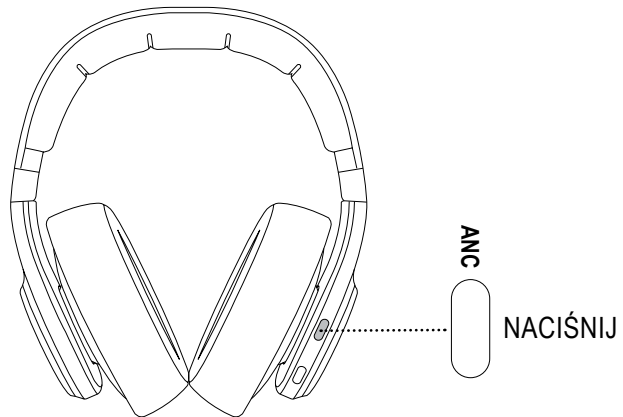

MUZYKA I POŁĄCZENIA TELEFONICZNE

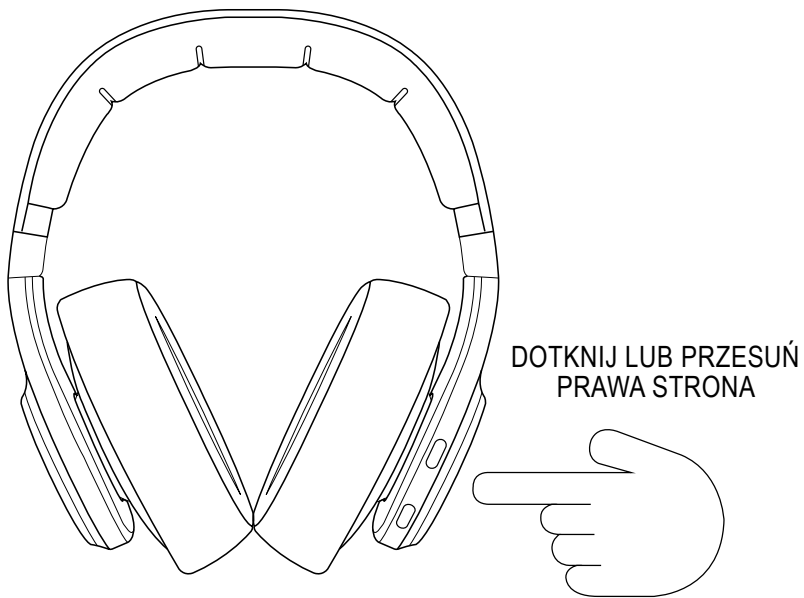

MUZYKA

POŁĄCZENIA TELEFONICZNE

ASYSTENT GŁOSOWY

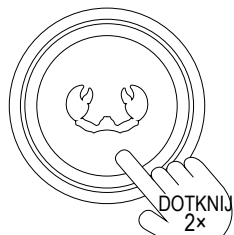

ODTWARZAJ / PAUZA

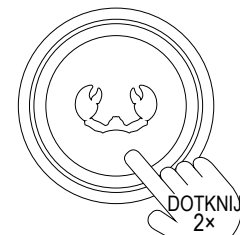

ODBIERZ POŁĄCZENIE



ASYSTENT GŁOSOWY

POGŁOŚNIJ

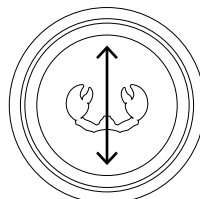

ŚCISZ

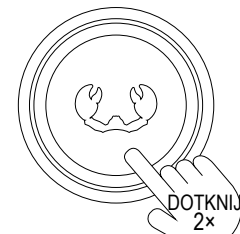

ZAKOŃCZ ROZMOWĘ

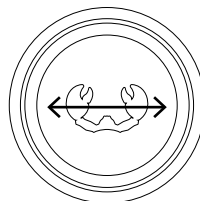

WSTECZ / DALEJ

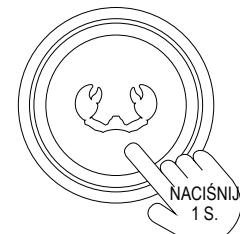

ODRZUĆ POŁĄCZENIE

BUTOANE

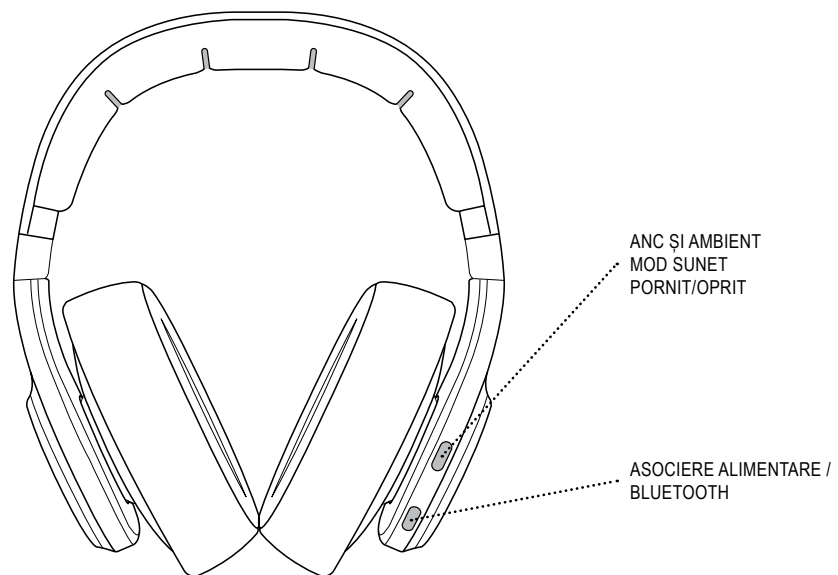

LED-URI

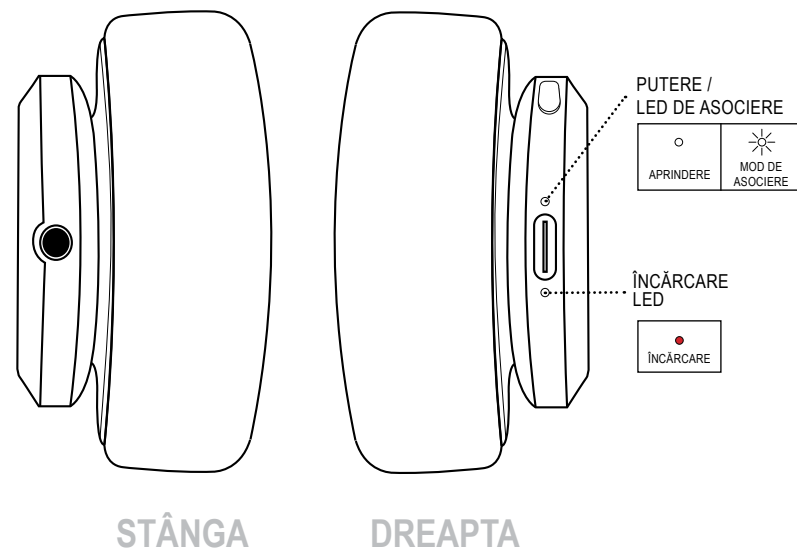

NOȚIUNI DE BAZĂ

1.

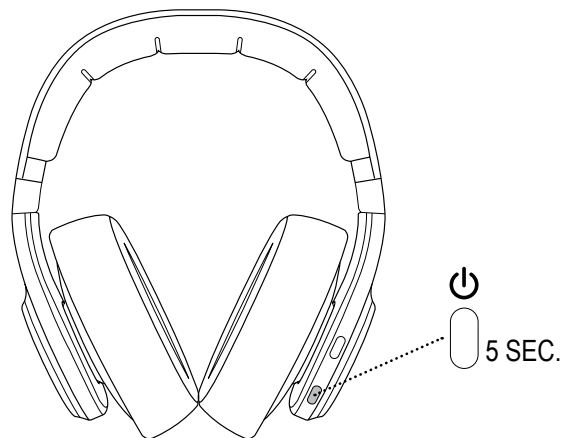

3.

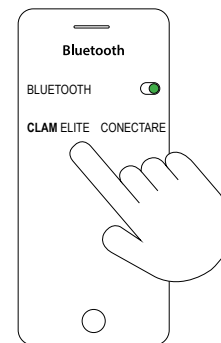

2.

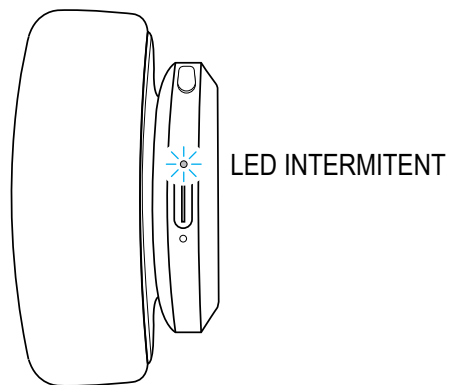

4.

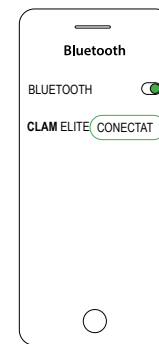

OPERAȚIUNE

UTILIZARE GENERALĂ - FUNCȚIONARE ANC

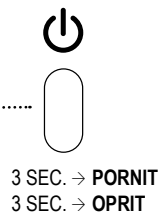
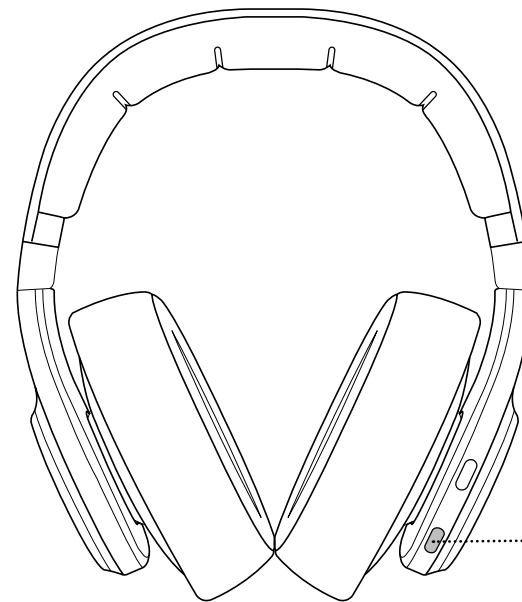
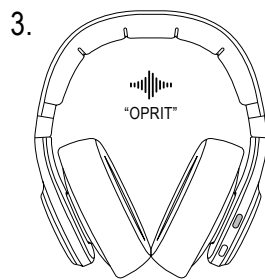
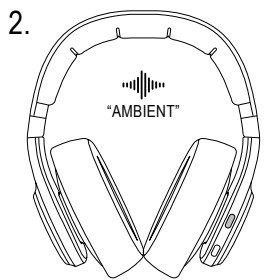
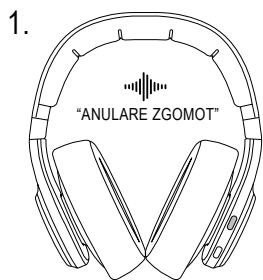
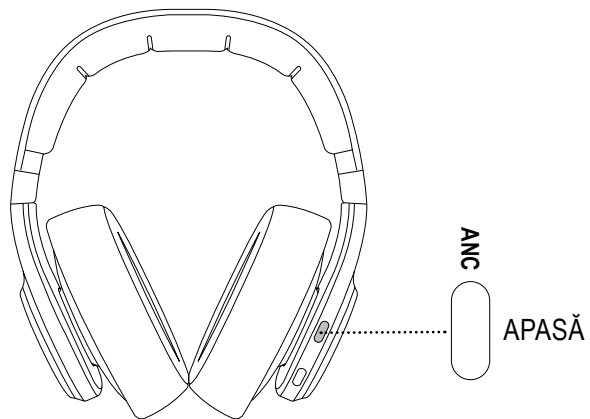

MUZICĂ & APELURI

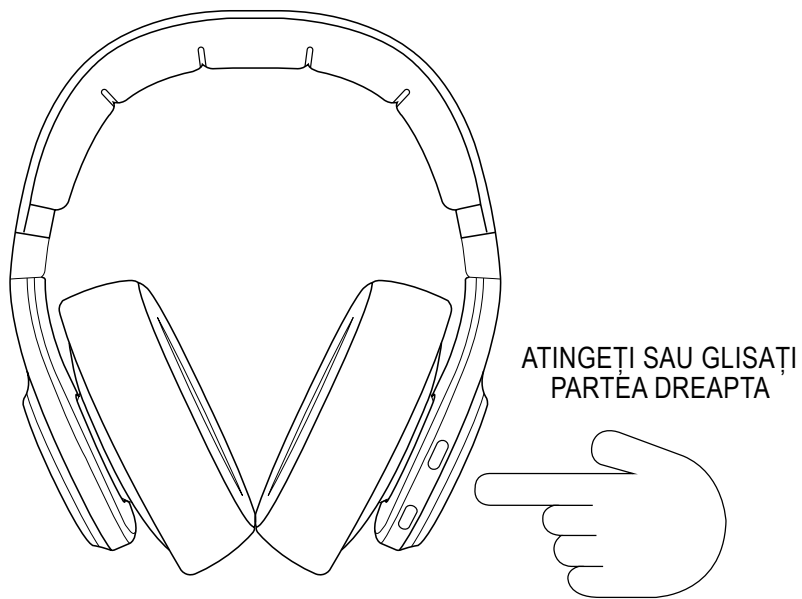

MUZICĂ

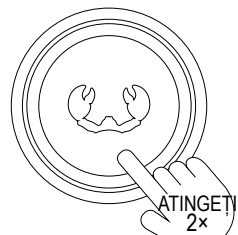

REDARE / PAUZĂ

APELURI TELEFONICE

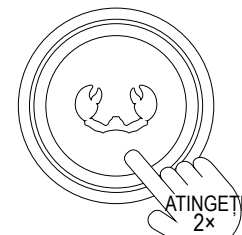

PRELUARE APEL

ASISTENT VOCAL

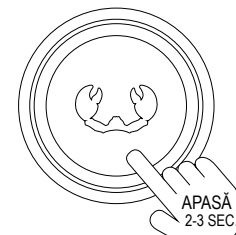

ASISTENT VOCAL

CREȘTERE VOLUM

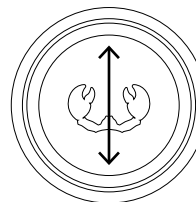

SCĂDERE VOLUM

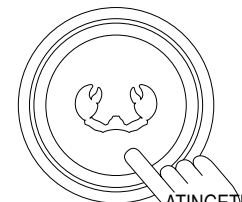

ÎNCHIEIERE APEL

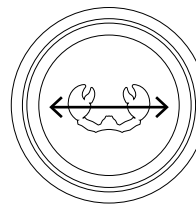

ANTERIOARA / URMĂTOAREA

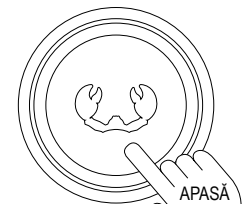

RESPINGERE APEL

ΚΟΥΜΠΙΑ

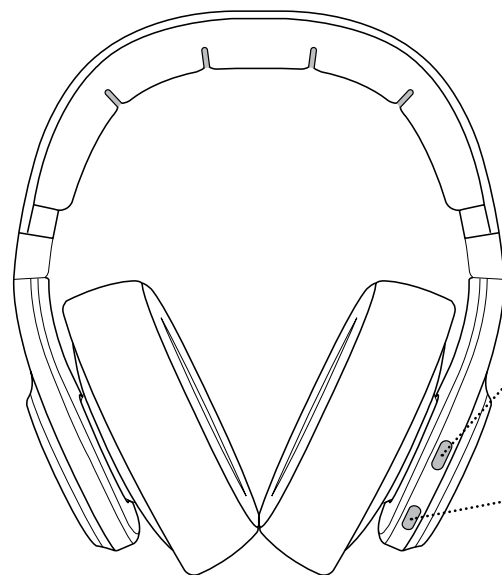

ANC ΚΑΙ ΠΕΡΙΒΑΛΛΟΝ
ΛΕΙΤΟΥΡΓΙΑ ΗΧΟΥ
ΕΝΕΡΓΟΠΟΙΗΣΗ /
ΑΠΕΝΕΡΓΟΠΟΙΗΣΗ

ΣΥΖΕΥΞΗ ΤΡΟΦΟΔΟΣΙΑΣ /
BLUETOOTH

ΛΥΧΝΙΕΣ LED

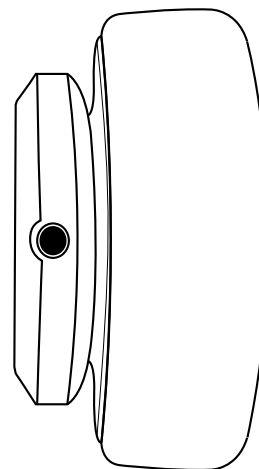

ΑΡΙΣΤΕΡΑ

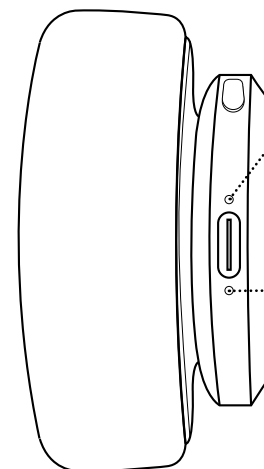

ΔΕΞΙΑ

ΤΡΟΦΟΔΟΣΙΑ /
ΣΥΖΕΥΞΗ LED



ΦΟΡΤΙΣΗ
LED



ΑΣ ΞΕΚΙΝΗΣΟΥΜΕ

1.

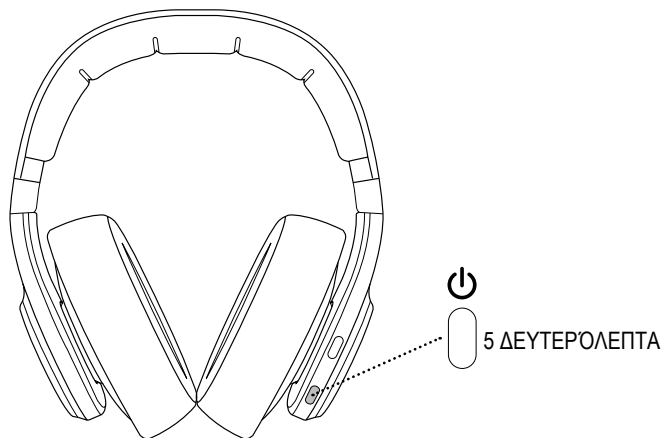

3.

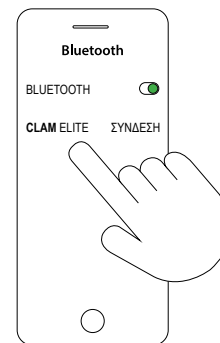

2.

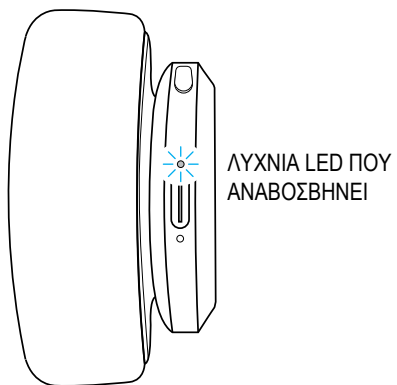

4.

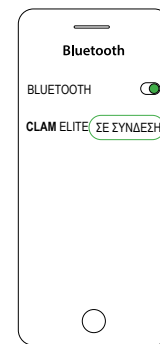

ΓΕΝΙΚΗ ΧΡΗΣΗ - ΛΕΙΤΟΥΡΓΙΑ ANC

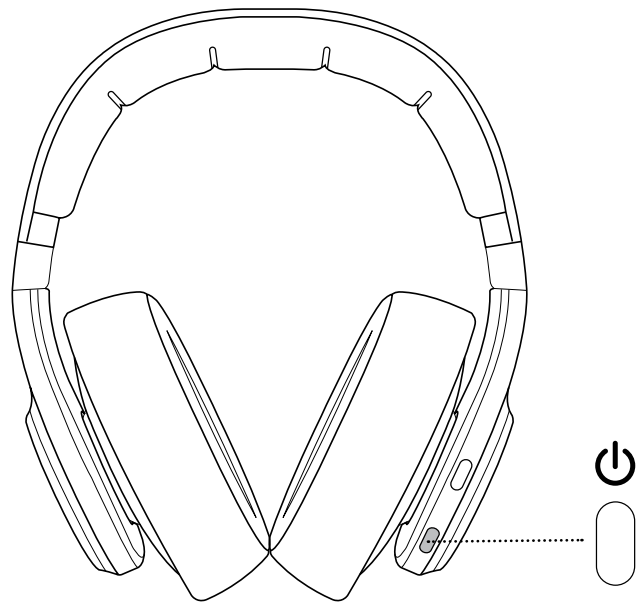
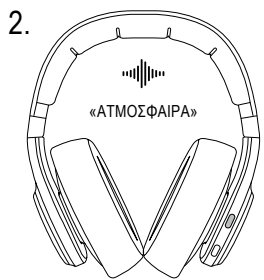
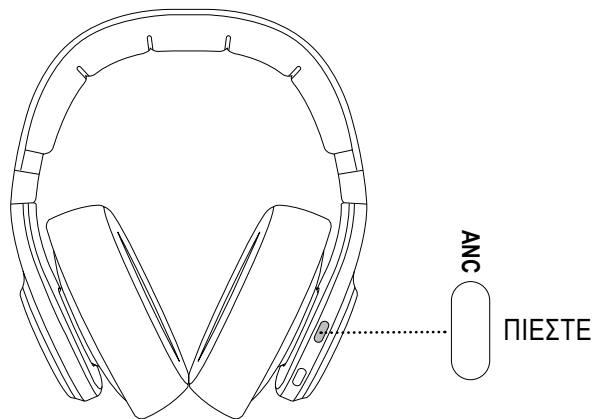

3 ΔΕΥΤ. → ΕΝΕΡΓΟΠΟΙΗΣΗ
3 ΔΕΥΤ. → ΑΠΕΝΕΡΓΟΠΟΙΗΣΗ

ΜΟΥΣΙΚΗ ΚΑΙ ΤΗΛΕΦΩΝΙΚΕΣ ΚΛΗΣΕΙΣ

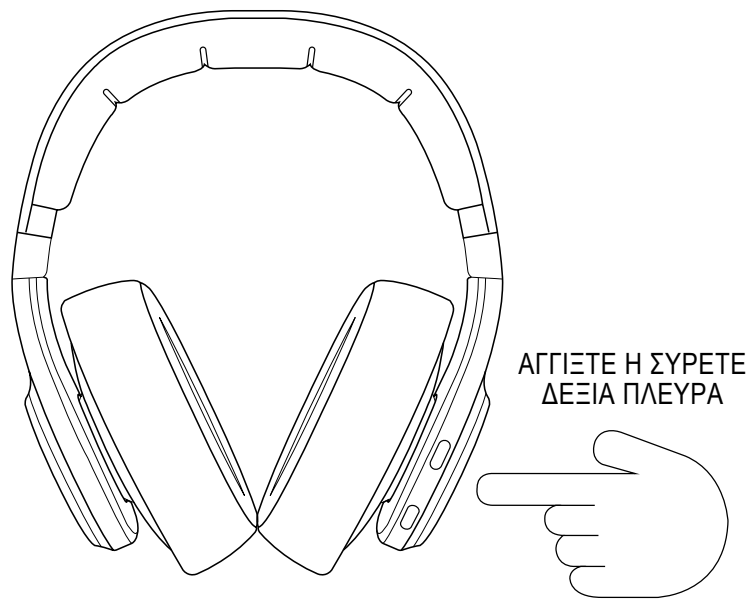

ΜΟΥΣΙΚΗ

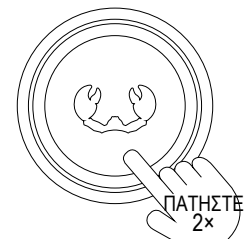

ΑΝΑΠΑΡΑΓΩΓΗ / ΠΑΥΣΗ

ΤΗΛΕΦΩΝΙΚΕΣ ΚΛΗΣΕΙΣ

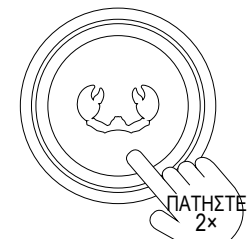

ΑΠΑΝΤΗΣΗ ΚΛΗΣΗΣ

ΦΩΝΗΤΙΚΟΣ ΒΟΗΘΟΣ



ΦΩΝΗΤΙΚΟΣ ΒΟΗΘΟΣ

ΑΥΞΗΣΗ ΕΝΤΑΣΗΣ

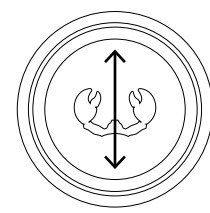

ΜΕΙΩΣΗ ΕΝΤΑΣΗΣ



ΤΕΛΟΣ ΚΛΗΣΗΣ

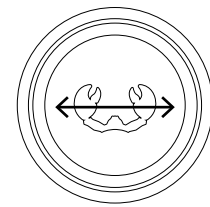

ΠΡΟΗΓΟΥΜΕΝΟ/ΕΠΟΜΕΝΟ



ΑΠΟΡΡΙΨΗ ΚΛΗΣΗΣ

КНОПКИ

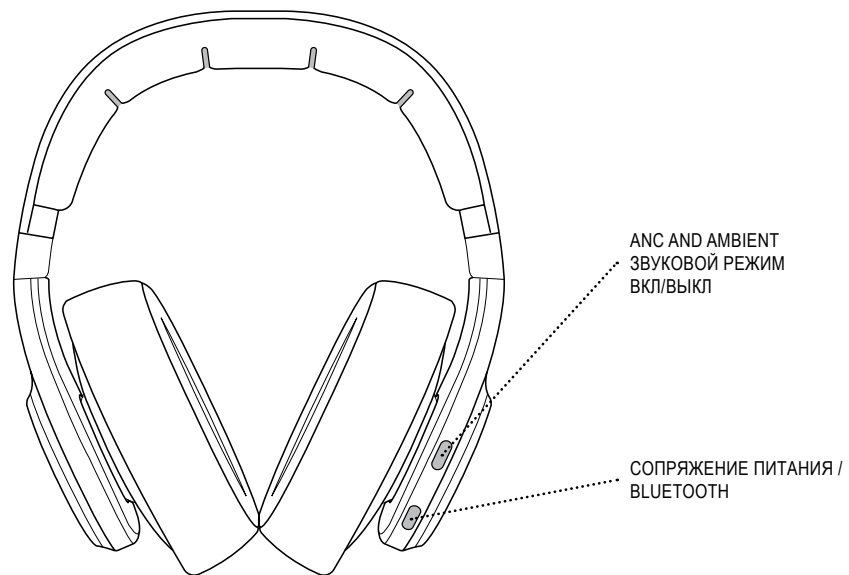

СВЕТОДИОДЫ

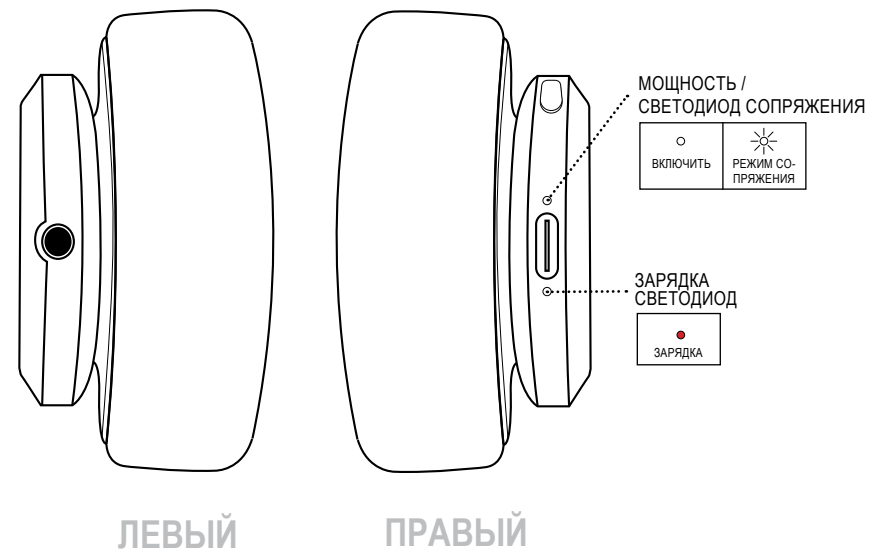

ЗАПУСК В РАБОТУ

1.

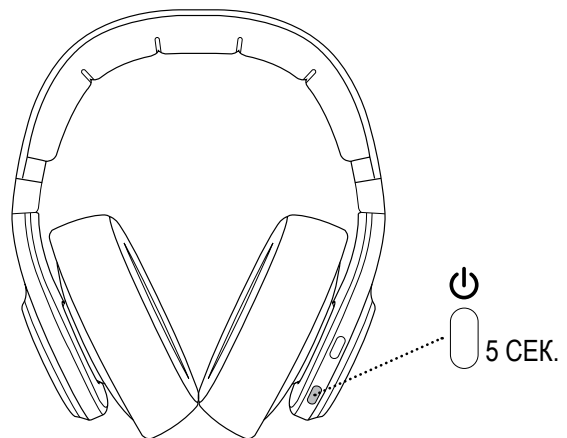

3.



2.

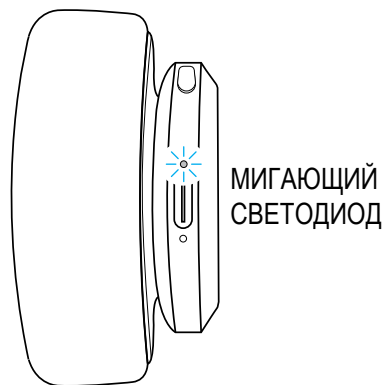

4.

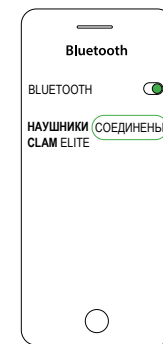

ОБЩЕЕ ИСПОЛЬЗОВАНИЕ - КАК
ПОЛЬЗОВАТЬСЯ ANC

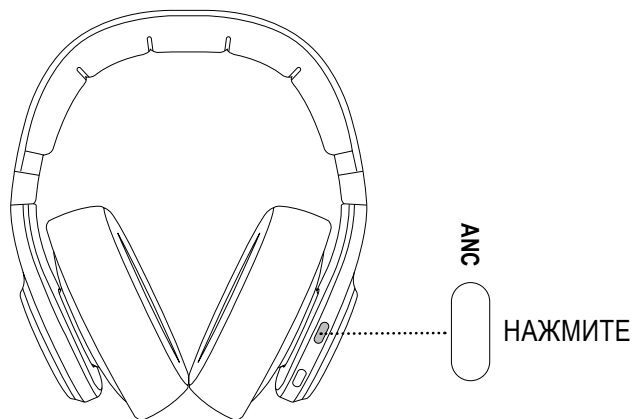

1.



2.

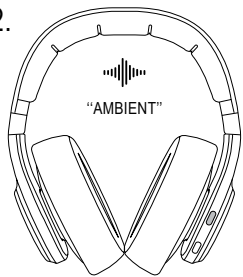

3.

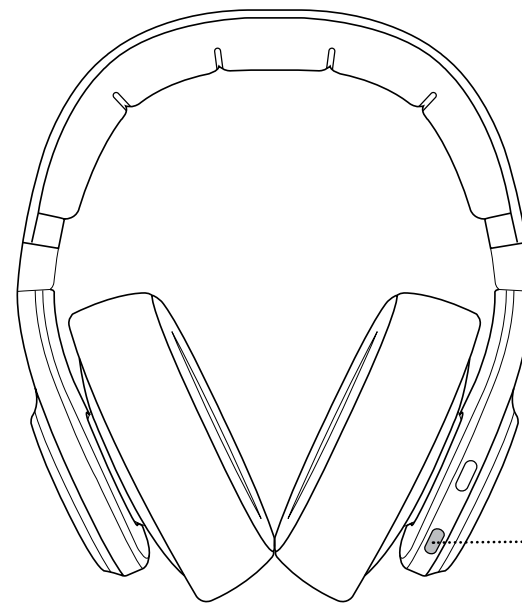

3 СЕК. → ВКЛ.
3 СЕК. → ВЫКЛ.

МУЗЫКА И ТЕЛЕФОННЫЕ ЗВОНКИ



МУЗЫКА

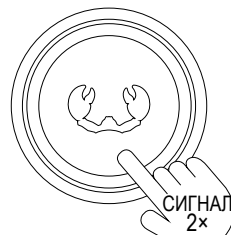

ВОСПРОИЗВЕДЕНИЕ / ПАУЗА

ТЕЛЕФОННЫЕ ЗВОНКИ

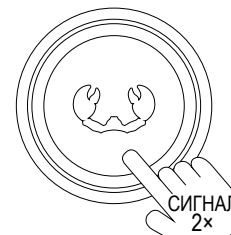

ПОЗВОНИТЬ

ГОЛОСОВОЙ ПОМОЩНИК



ГОЛОСОВОЙ ПОМОЩНИК

УВЕЛИЧИТЬ ГРОМКОСТЬ

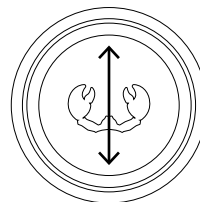

УМЕНЬШИТЬ ЗВУК

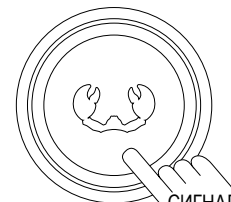

ЗАВЕРШИТЬ ЗВОНОК

ПРЕДЫДУЩИЙ / СЛЕДУЮЩИЙ

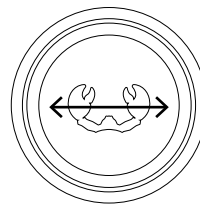

ОТКЛОНИТЬ ВЫЗОВ