



User Guide

Quality, Design and Innovation



home.liebherr.com/fridge-manuals

LIEBHERR

Contents

1	Appliance at a glance	2	9.2	Operating noises.....	21
1.1	Scope of delivery.....	2	9.3	Technical fault.....	21
1.2	Overview of the appliance and its equipment.....	3	9.4	Customer Services.....	23
1.3	Appliance range of use.....	3	9.5	Model plate.....	23
1.4	Conformity.....	3	10	Shutting down	23
1.5	EPREL database.....	3	11	Disposing of the appliance	23
2	General safety instructions	3	The manufacturer works constantly on the further development of all the types and models. Therefore please understand that we have to reserve the right to make design, equipment and technical modifications.		
3	Putting into operation	5	To get to know all the benefits of your new appliance, please read the information contained in these instructions carefully.		
3.1	Switching on appliance.....	5	The instructions apply to several models. Differences may occur. Text relating only to specific appliances is marked with an asterisk (*).		
3.2	Inserting the components.....	5	Instructions for action are marked with a ►, the results of action are marked with a ▢.		
4	Foods management	5	This User Guide applies to:		
4.1	Storing food.....	5	-	IRBd 4050	
4.2	Storage times.....	6	-	IRBd 4150	
5	Saving energy	7	-	IRBd 4151	
6	Controls	7	-	IRBb 4170	
6.1	Controls and displays.....	7	-	IRBd 4171	
6.1.1	Status display.....	7	-	IRBd 4550	
6.1.2	Navigation.....	7	-	IRBd 4570	
6.1.3	Display symbols.....	7	-	IRBd 4571	
6.2	Control concept.....	8	-	IRBe 4851	
6.2.1	Activating/deactivating the function.....	8	-	IRBd 5150	
6.2.2	Select the function value.....	8	-	IRBdi 5150	
6.2.3	Activating/deactivating settings.....	8	-	IRBd 5151	
6.2.4	Selecting the setting value.....	8	-	IRBd 5151	
6.2.5	Go to the Customer menu.....	8	-	IRBd(i) 5180	
6.3	Functions.....	9	-	IRBdi 5190	
6.3.1	Setting the temperature.....	9	-	IRBd(i) 5171	
	SuperCool.....	9	-	IRBdi 5191	
	PartyMode.....	9	-	IRBc(i) 5170	
	HolidayMode.....	9			
	EnergySaver.....	9			
	HydroBreeze*.....	9			
6.4	Settings.....	10			
	Language.....	10			
	Connecting to the WLAN.....	10			
	Entry lock.....	10			
	Display brightness.....	10			
	Door alarm.....	11			
	Info.....	11			
	SabbathMode.....	11			
	CleaningMode.....	11			
	BioFresh B-Value.....	11			
	Reminder.....	11			
	Switching the appliance off.....	12			
6.5	Warnings.....	12			
6.5.1	Message.....	12			
6.5.2	DemoMode.....	12			
7	Features	12			
7.1	4-star freezer compartment*.....	12			
7.2	Door rack.....	12			
7.3	Shelves.....	13			
7.4	Dividing shelf.....	14			
7.5	VarioSafe*.....	14			
7.6	InfinitySpring*.....	14			
7.7	Space for baking tray.....	15			
7.8	Adjustable bottle shelf.....	15			
7.9	Drawers.....	15			
7.10	Fruit & Vegetable safe cover.....	16			
7.11	Adjusting the moisture levels.....	16			
7.12	HydroBreeze*.....	16			
7.13	Accessories.....	17			
8	Maintenance	19			
8.1	FreshAir carbon filter.....	19			
8.2	Defrosting the appliance.....	19			
8.3	Cleaning the appliance.....	20			
9	Customer help	21			
9.1	Technical specifications.....	21			

1 Appliance at a glance

1.1 Scope of delivery

Check all parts for damage during transport. If you have any complaints, please contact your retailer or Customer Services (see 9.4 Customer Services) .

Your new appliance comes with the following parts:

- Built-in appliance
- Features (depending on the model)
- Installation materials (depending on the model)
- "Quick Start Guide"
- "Installation Guide"
- Service Brochure

1.2 Overview of the appliance and its equipment

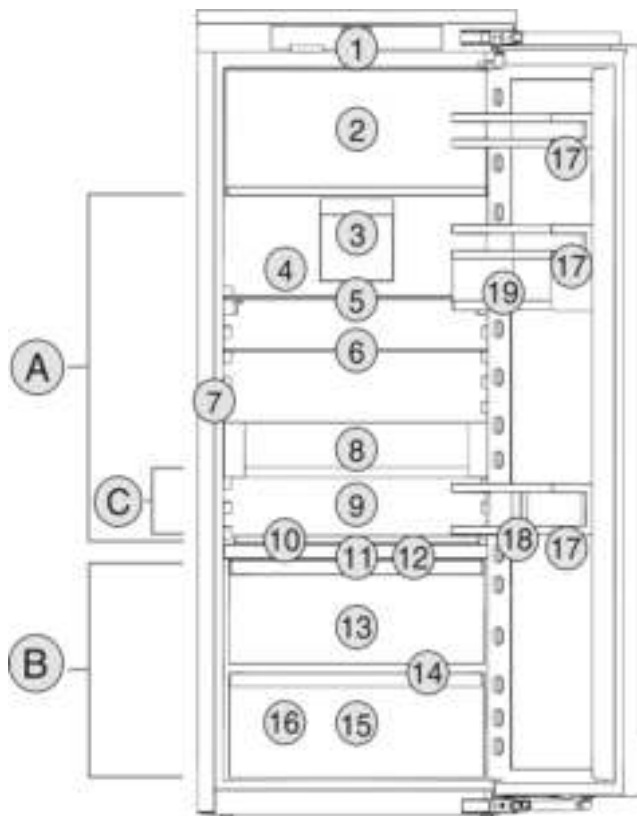

Fig. 1 Example illustration

Temperature range

- (A) Fridge section (B) BioFresh
(C) Coldest zone

Features

- (1) Controls (11) HydroBreeze*
(2) 4-star freezer* (12) Fruit & Vegetable-Safe cover
(3) Fan with FreshAir active carbon filter (13) Fruit & Vegetable-Safe
(4) Stainless steel back wall (14) Drainage outlet
(5) Split shelf (15) Meat & Dairy-Safe
(6) Shelf (16) Nameplate
(7) InfinitySpring* (17) Door rack
(8) VarioSafe* (18) Bottle rack
(9) Space for baking tray (19) VarioBoxes*
(10) Adjustable bottle shelf

Note

- The default arrangement of the shelves, drawers and baskets is best for energy efficiency.

1.3 Appliance range of use

Intended use

The appliance is only suitable for cooling food products in a domestic or household-like environment. This includes, for example, use:

- in staff kitchens, bed and breakfast establishments,
- by guests in country houses, hotels, motels and other accommodation,
- for catering and similar services in the wholesale trade.

The appliance is not suitable for freezing food;* All other types of use are not permitted.

Foreseeable misuse

The following applications are expressly forbidden:

- Storing and refrigerating medicines, blood plasma, laboratory preparations or similar substances and products based on the Medical Device Directive 2007/47/EC
- Use in areas at risk of explosions

Misusing the appliance may lead to damage to the goods stored or they may spoil.

Climate classifications

Depending on the climate classification the appliance is designed to operate in restricted ambient temperatures. The climate classification applying to your appliance is printed on the rating plate.

Note

- Keep to the specified ambient temperatures in order to guarantee that the appliance works properly.

Climate classification	for ambient temperatures of
SN	10 °C to 32 °C
N	16 °C to 32 °C
ST	16 °C to 38 °C
T	16 °C to 43 °C

1.4 Conformity

The refrigerant circuit has been tested for leaks. In installed condition, this appliance complies with the applicable safety stipulations and with directives 2014/35/EU, 2014/30/EU, 2009/125/EG, 2011/65/EU and 2010/30/EU.

The BioFresh compartment meets the requirements of a cold storage compartment as set out in DIN EN 62552:2020.

1.5 EPREL database

Details about energy labelling and ecodesign requirements will be available on the European product database (EPREL) from 1st March 2021. You can access the product database at the following link: <https://eprel.ec.europa.eu/> You will be asked to enter the model ID. You can find the model ID on the nameplate.

2 General safety instructions

Danger for the user:

- This device can be used by children and people with impaired physical, sensory or mental abilities or with a lack of experience and knowledge provided that they are supervised or have received instruction in the safe use of this device, and about the

General safety instructions

resulting hazards. Children must not play with this appliance. Cleaning and user maintenance work must not be carried out by children without adult supervision. Children aged between 3 and 8 are allowed to load and unload the appliance. Children below the age of 3 must be kept away from the appliance unless they are under continuous adult supervision.

- When disconnecting the appliance from the supply, always take hold of the plug. Do not pull the cable.
- In the event of a fault pull out the mains plug or deactivate the fuse.
- Do not damage the mains power cable. Do not operate the appliance with a defective mains power cable.
- Only customer service or other specially trained staff may repair or perform other operations on the appliance.
- Only install, connect and dispose of the appliance according to the instructions.
- Only use the appliance when it is installed.
- Please keep these instructions in a safe place and pass them on to any subsequent owners.
- The manufacturer is not liable for damage caused by a faulty fixed water connection.*

Fire hazard:

- The coolant used (information on the model plate) is eco-friendly but also flammable. Any leaking coolant may ignite.
 - Do not damage the refrigerant circuit pipes.
 - Do not handle ignition sources inside the appliance.
 - Do not use electrical appliances inside the appliance (e.g. steam cleaners, heaters, ice cream makers, etc.).
 - If the refrigerant leaks: remove any naked flames or ignition sources from the vicinity of the leakage point. Properly air the room. Inform customer services.
- Do not store explosives or sprays using combustible propellants such as butane, propane, pentane, etc. in the appliance. To identify these spray cans, look for the list of contents printed on the can, or a flame symbol. Gases possibly escaping may ignite due to electrical components.
- Please be sure to store alcoholic drinks or other packaging containing alcohol in tightly closed containers. Any alcohol that leaks out may be ignited by electrical components.

Danger of tipping and falling:

- Do not misuse the plinth, drawers, doors etc. as a step or for support. This applies particularly to children.

Danger of food poisoning:

- Do not consume food which has been stored too long.

Danger of frostbite, numbness and pain:

- Avoid prolonged skin contact with cold surfaces or refrigerated/frozen goods or take protective measures, e.g wear use gloves.

Danger of injury and damage:

- Hot steam can lead to injury. Do not use electrical heating or steam cleaning equipment, open flames or defrosting sprays to defrost.
- Do not use sharp implements to remove the ice.

Danger of crushing:

- Do not hold the hinge when opening and closing the door. Fingers may get caught.

Risk of damage to slate front:

- Please do not affix stickers to the front.

Symbols on the appliance:



The symbol can be located on the compressor. It refers to the oil in the compressor and indicates the following danger: Swallowing or inhaling can be fatal. This is only relevant for recycling. There is no danger in normal operation.



This symbol is found on the compressor and indicates the danger of flammable materials. Do not remove the sticker.



A sticker to this effect may be applied to the rear of the appliance. It refers to the foam-padded panels in the door and/or the housing. This is only relevant for recycling. Do not remove the sticker.

Please observe the specific information in the other sections:

	DANGER	identifies a situation involving direct danger which, if not obviated, may result in death or severe bodily injury.
	WARNING	identifies a dangerous situation which, if not obviated, may result in death or severe bodily injury.
	CAUTION	identifies a dangerous situation which, if not obviated, may result in minor or medium bodily injury.
	NOTICE	identifies a dangerous situation which, if not obviated, may result in damage to property.

Note	It contains useful instructions and tips.
------	---

3 Putting into operation

3.1 Switching on appliance

Ensure that the following conditions are met:

- Appliance is installed and connected according to installation instructions.
- All adhesive strips, adhesive and protective films as well as transport safety devices in and on the appliance are removed.
- All marketing leaflets are removed from the drawers.
- ▶ Switching on the appliance



Fig. 2

- ▶ After turning on the appliance, select the language.



Fig. 3

- ▶ The status screen appears.
- ▶ If DemoMode appears along with the blue screen after the appliance is switched on, you can disable DemoMode within the next 5 minutes.

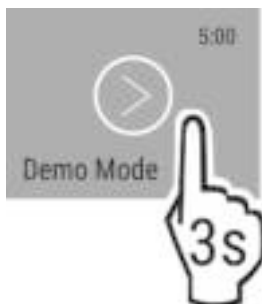

Fig. 4

- ▶ Press DemoMode for 3 seconds.
- ▷ DemoMode is off.

Note

The manufacturer recommends:

- ▶ Storing food: wait around 2 hours for the appliance to reach the set temperature.
- ▶ Store frozen produce at -18 °C or colder.*

3.2 Inserting the components

- ▶ Insert the supplied components to make the most of your appliance.
- ▶ Purchase and install the SmartDevice Box (see <https://smartdevice.liebherr.com/install>).*
- ▶ Install the SmartDevice app (see <https://apps.home.liebherr.com/>).
- ▶ Insert the water tank.*
- ▶ Insert the water filter.*

Note

You can purchase accessories from the [Liebherr household appliance store](http://home.liebherr.com) (home.liebherr.com).

4 Foods management

4.1 Storing food



WARNING

Risk of fire

- ▶ Do not use any electrical appliances in the food area of the appliance unless recommended by the manufacturer.

When storing food, always observe the following:

- Air vents on the inside rear wall are unobstructed.
- Air vents on the fan are unobstructed.
- Food is in sealed packaging.
- Foods that easily absorb or give off smell or taste are stored in sealed containers or covered.
- Raw meat and fish are in clean, sealed containers to prevent them coming into contact with or dripping onto other foods.
- Liquids are in sealed containers.
- Foods are not stored too closely together, as the air needs to circulate.

Note

Failure to follow these guidelines can lead to food perishing.

4.1.1 Fridge section

The natural air circulation creates a range of temperatures.

Arrange your food as follows:

- ▶ In the top section and in the door: butter and cheese, preserves and tubes.
- ▶ In the coldest zone Fig. 1 (C): easily perishable food such as prepared meals.

4.1.2 BioFresh

BioFresh helps certain fresh foods stay fresh for longer compared to conventional cooling methods.

In the case of foods with a minimum shelf life, the date indicated on the packaging still applies.

If the temperature drops below 0 °C, foods can freeze.

Note

Store cold-sensitive fruit and vegetables such as cucumbers, aubergines, courgettes and tropical fruit in the cooling section.

Fruit & Vegetable-Safe

This provides a fresh storage climate with the lid closed. A moist climate is suitable for storing loose foods with a high moisture content (e.g. salad, vegetables, fruit).

The air moisture in the compartment depends on the moisture content of the items being stored and the number of times the door is opened. You can adjust the air moisture.

Foods management

Arrange your food as follows:

- ▶ Store your loose fruit and vegetables.
- ▶ Excessive air moisture: Regulate the air humidity (see 7.11 Adjusting the moisture levels) .

Meat & Dairy-Safe

Here a relatively dry storage climate is set. A dry climate is great for dry or packaged foods (e.g. dairy products, meat, fish, sausage).

Arrange your food as follows:

- ▶ Place the dry or packaged foods inside.

4.1.3 Freezer compartment*

The air temperature can vary in the compartment when shown on a thermometer or other gauges. The temperature varies more when the compartment is half-full or empty and can rise to more than -18 °C.

Freezing food

You can freeze as many kilograms of fresh food within 24 hours as is indicated on the model plate .

So that the food is rapidly frozen through to the core, keep to the following quantities per pack:

- Fruit, vegetables up to 1 kg
- Meat up to 2.5 kg

Before freezing goods, please note the following:*

- For maximum freezing capacity: remove glass plate.

Arrange your food as follows:



CAUTION

Risk of injury from glass fragments!
Drink bottles and cans may explode if frozen. This applies particularly to carbonated drinks.

- ▶ Do not freeze bottles and cans of drink!
- ▶ Put the packaged food into the freezer compartment so that it is in contact with the floor or the side walls.

Defrost the food

- In the fridge
- In the microwave
- In the stove/oven
- At room temperature



WARNING

Risk of food poisoning!

- ▶ Do not re-freeze thawed food.
- ▶ Only take out the food you need at the time.
- ▶ Cook defrosted food as soon as possible.

4.2 Storage times

Refer to the specified storage times as a guide.

In the case of foods with a minimum shelf life, the date indicated on the packaging still applies.

4.2.1 Fridge section

Always follow the best-before date stated on the packaging.

4.2.2 BioFresh

Note

You can also use the guides in the BioFresh app <https://home.liebherr.com/de/deu/service/apps/landing-page-apps-emea.html> .

Recommended storage periods in the Meat & Dairy-Safe		
Butter	at 1 °C	up to 90 days
Hard cheese	at 1 °C	up to 110 days
Milk	at 1 °C	up to 12 days
Sausage, cold meats	at 1 °C	up to 8 days
Poultry	at 1 °C	up to 6 days
Pork	at 1 °C	up to 6 days
Beef	at 1 °C	up to 6 days
Game	at 1 °C	up to 6 days

Note

- ▶ Remember that high-protein foods perish quicker; shellfish and crustaceans do not last as long as fish, and fish does not last as long as meat.

Recommended storage periods in the Fruit & Vegetable-Safe		
Vegetables, salads		
Artichokes	at 1 °C	up to 14 days
Celery	at 1 °C	up to 28 days
Cauliflower	at 1 °C	up to 21 days
Broccoli	at 1 °C	up to 13 days
Chicory	at 1 °C	up to 27 days
Lettuce	at 1 °C	up to 19 days
Peas	at 1 °C	up to 14 days
Kale	at 1 °C	up to 14 days
Carrots	at 1 °C	up to 80 days
Garlic	at 1 °C	up to 160 days
Turnip	at 1 °C	up to 14 days
Lettuce	at 1 °C	up to 13 days
Herbs	at 1 °C	up to 13 days
Leeks	at 1 °C	up to 29 days
Mushrooms	at 1 °C	up to 7 days
Radishes	at 1 °C	up to 10 days
Brussels sprouts	at 1 °C	up to 20 days
Asparagus	at 1 °C	up to 18 days
Spinach	at 1 °C	up to 13 days
Savoy	at 1 °C	up to 20 days
Fruit		
Apricots	at 1 °C	up to 13 days
Apples	at 1 °C	up to 80 days
Pears	at 1 °C	up to 55 days
Blackberries	at 1 °C	up to 3 days
Dates	at 1 °C	up to 180 days

Recommended storage periods in the Fruit & Vegetable-Safe		
Strawberries	at 1 °C	up to 7 days
Figs	at 1 °C	up to 7 days
Blueberries	at 1 °C	up to 9 days
Raspberries	at 1 °C	up to 3 days
Currants	at 1 °C	up to 7 days
Sweet cherries	at 1 °C	up to 14 days
Kiwis	at 1 °C	up to 80 days
Peaches	at 1 °C	up to 13 days
Plums	at 1 °C	up to 20 days
Cranberries	at 1 °C	up to 60 days
Rhubarb	at 1 °C	up to 13 days
Gooseberries	at 1 °C	up to 13 days
Grapes	at 1 °C	up to 29 days

4.2.3 Freezer compartment*

Recommended storage period for various types of food		
Ice cream	at -18 °C	2 to 6 months
Sausages, ham	at -18 °C	2 to 3 months
Bread, baked goods	at -18 °C	2 to 6 months
Game, pork	at -18 °C	6 to 9 months
Fatty fish	at -18 °C	2 to 6 months
Lean fish	at -18 °C	6 to 8 months
Cheese	at -18 °C	2 to 6 months
Poultry, beef	at -18 °C	6 to 12 months
Vegetables, fruit	at -18 °C	6 to 12 months

5 Saving energy

- Pay attention to good ventilation. Do not cover ventilation holes or grids.
- Always keep the fan air slits clear.
- Do not install the appliance in direct sunlight, next to an oven, radiator or similar.
- Energy consumption depends on the installation conditions, e.g. the ambient temperature (see 1.3 Appliance range of use) . A warmer ambient temperature can increase the energy consumption.
- Open the appliance for as short a time as possible.
- The lower the temperature is set the higher the energy consumption.
- Sort your food: home.liebherr.com/food.
- Keep all food properly packed and covered. This prevents frost from forming.
- Only take food out for as long as necessary so that it doesn't warm up too much.
- Inserting warm food: allow to cool down to room temperature first.
- Thaw frozen food in the refrigerator.*
- If there is a thick layer of frost in the appliance: defrost the appliance.*
- For longer periods of absence, use HolidayMode .

6 Controls

6.1 Controls and displays

The display provides a quick overview of the temperature setting and the status of functions and settings. You can control the functions and settings either by deactivating/activating them or by selecting a value.

6.1.1 Status display

The Status display shows the set temperatures and is the home display. From there, you can navigate to the options and settings.

6.1.2 Navigation

Navigate in the menu to see the individual functions. An audible signal sounds after confirming a function or setting. If no selection is made after 10 s the display switches to the Status screen.

The appliance is operated by swiping and confirming in the display:



Fig. 5

Back:

- Confirm your selection in the submenu. The display returns to the menu.



. The display returns to the function/setting.

Back to Status display:

- Close and open the door.
- Wait 10 s. The display switches to the Status display.

6.1.3 Display symbols

Display symbols provide information on the current appliance status:





Symbol	Appliance status
	Standby The appliance or temperature zone is switched off.
	Flashing number Appliance is working. Temperature flashes until the set temperature is reached.
	Flashing symbol Appliance is working. Setting is made.

Controls

6.2 Control concept

6.2.1 Activating/deactivating the function

You can activate/deactivate the following functions:

Symbol	Function
	SuperCool ^x
	PartyMode ^x
	HolidayMode
	EnergySaver
	HydroBreeze [*]

^x When a function is on, the appliance works harder. This means the appliance could make louder noises and consume more energy.

- ▶ Swipe left in the display until the function appears.
- ▶ Confirm selected function with a short tap.
- ▷ You hear the confirmation tone.
- ▷ Status appears in the menu.
- ▷ Function is on/off.

6.2.2 Select the function value

With the following functions you can set a value in the submenu:

Symbol	Function
	Setting the temperature Turn on/off the temperature zone

- ▶ Swipe left in the display until the function appears.
- ▶ Confirm selected function with a short tap.
- ▶ Swipe in the display to select the setting value.

Setting the temperature



- ▶ Confirm with a short tap.
- ▷ You hear the confirmation tone.
- ▷ The display changes to blue when active.
- ▷ Display switches back to the menu.





Switching the temperature zone on/off

- ▶ To Confirm, press for 3 seconds.
- ▷ You hear the confirmation tone.
- ▷ Display returns to the Status screen.

6.2.3 Activating/deactivating settings

You can activate/deactivate the following settings:

Symbol	Setting
	WiFi ¹
	Entry lock ²
	SabbathMode ²

Symbol	Setting
	Cleaning Mode ²
	Reminders ¹
	Reset ²
	Off ²

- ▶ Swipe left in the display until Settings  appears.
- ▶ Confirm settings by tapping.
- ▶ Swipe until you see the setting you want.

¹ Activate setting (shortpress)



- ▶ Confirm with a short tap.
- ▷ You hear the confirmation tone.
- ▷ Status appears in the menu.
- ▷ Setting is activated/deactivated.

² Activate setting (longpress)

- ▶ Press the selection for 3 seconds to confirm.
- ▷ You hear the confirmation tone.
- ▷ Status appears in the menu.
- ▷ Display changes.

6.2.4 Selecting the setting value



With the following settings you can set a value in the submenu:



Symbol	Settings
	Brightness
	Door alarm
	Language

- ▶ Swipe left in the display until Settings appears.
- ▶ Confirm settings by tapping.
- ▶ Swipe until you see the setting you want.
- ▶ Confirm with a short tap.
- ▶ Swipe in the display to select the setting value.
- ▶ Confirm with a short tap.
- ▷ You hear the confirmation tone.
- ▷ Status appears briefly in the submenu.
- ▷ Display switches back to the menu.

6.2.5 Go to the Customer menu

You can see the following settings in the Customer menu:

Symbol	Function
	BioFresh B-Value ¹
	D-Value ¹

- ▶ Swipe left in the display until Settings  appears.
- ▶ Confirm settings by tapping.
- ▶ Swipe until About appliance  appears in the display.
- ▶ Confirm with a short tap.
- ▶ Go to the Customer menu: Enter the code 151.

- ▶ Swipe in the customer menu until you see the setting you want.

1 Select the value

- ▶ Confirm with a short tap.
- ▷ You hear the confirmation tone.
- ▷ Status appears briefly in the display.
- ▷ Display switches back to the menu.

2 Activate the setting



- ▶ To confirm, press the display for 3 seconds.
- ▷ You hear the confirmation tone.
- ▷ Status appears on the display.
- ▷ The symbol flashes as long as the appliance is working.

6.3 Functions

6.3.1 Setting the temperature

The temperature depends on the following factors:

- The amount of times the door is opened
- How long the door is open for
- The room temperature of the installation site
- The type, temperature and amount of food

Temperature zone	Recommended setting
 5 °C section	Fridge 5 °C
 B5 BioFresh	B5

Setting the temperature

- ▶ Set the level (see 6.2 Control concept) .
- ▷ Set temperature is shown at the bottom right of the display.
- ▷ The current temperature flashes on the display.

Switching off a temperature zone

- ▶ Set the level (see 6.2 Control concept) .
- ▷  appears.

SuperCool

This function selects the lowest cooling temperature. This gives you colder storage temperatures.

This function is relevant to the fridge section *Fig. 1 (A)*

You can also reach lower temperatures in the 4-star freezer.*

Use:

- Cool large amounts of food quickly.
- Freeze food.*

Activating/deactivating the function

- ▶ Using the 4-star freezer: activate the function 3 hours beforehand.*
- ▶ Using the fridge section: activate the function when you add the goods.
- ▶ Activating/deactivating (see 6.2 Control concept) .
- or-
- ▶ Activating/deactivating in the Liebherr SmartDevice-App.*

The function automatically turns off. The appliance goes back to normal mode. The temperature adjusts itself to the set level.

PartyMode

This option offers an assortment of special functions and settings that are useful if you are having a party.

The following functions are on:

- *SuperCool*
- *IceMaker* and *MaxIce*
- *InfinitySpring*

All the functions can be adjusted flexibly and separately. Changes are discarded when the function turns off.

Activating/deactivating the function

- ▶ Activating/deactivating (see 6.2 Control concept) .
- ▷ On: All functions are activated at the same time.
- ▷ Off: Preset temperatures are restored.

After 24 hours the function turns off automatically.

HolidayMode

This function minimises the energy consumption during an extended absence. The temperature is increased to 15 °C.

Use:

- Save energy if you plan to be away for a while.
- Avoid coming home to bad smells and mould.

Activating/deactivating the function

- ▶ Empty everything from the fridge section.
- ▶ Activate/deactivate (see 6.2 Control concept) .
- ▷ On: Fridge temperature is raised.
- ▷ Off: preset temperature is restored.

EnergySaver

This function is designed to reduce energy consumption. Higher temperatures are preset for all temperature zones, which means the appliance has to cool less frequently.

Temperature of the fridge section: 7 °C

Temperature of the freezer section: -16 °C

Use:

- Save energy.

Activating/deactivating the function

- ▶ Activating/deactivating (see 6.2 Control concept) .
- ▷ On: Higher temperatures are preset for all temperature areas.
- ▷ Off: Preset temperatures are restored.

HydroBreeze*

HydroBreeze creates a fine mist in the drawer every 90 minutes for 4 seconds when the door is closed. This function is also activated when you open the door. The function is not activated when the appliance is delivered.

Use:

- Storage of unpackaged salad, vegetables and fruit with high moisture content.

Choose from these options:

- 1
Operating time when door is opened: 4 s
- 2
Operating time when door is opened: 6 s
- 3

Controls

- Operating time when door is opened: 8 s
- Off
 - HydroBreeze is off.

Activating/deactivating the function

- ▶ Activating/deactivating (see 6.2 Control concept) .
- or-
- ▶ Activating/deactivating in the Liebherr SmartDevice-App.*

6.4 Settings



Language

This setting lets you choose the language of the display.

Choose from the following languages:

- German
- English
- French
- Spanish
- Italian
- Dutch
- Czech
- Polish
- Portuguese
- Russian
- Ukrainian
- Chinese

Activating/deactivating settings

- ▶ Activating/deactivating (see 6.2 Control concept) .



Connecting to the WLAN

This setting connects the appliance to the internet. The connection is managed in the SmartDevice-Box. You can use the SmartDevice-App to add your appliance to a SmartHome-System. Use the SmartDevice-App or other compatible partner networks to enjoy advanced options and settings.

Note

The SmartDevice Box is available from the [Liebherr home appliance store \(home.liebherr.com\)](http://home.liebherr.com).

More information about availability, requirements and the individual options, can be found online at smartdevice.liebherr.com.

Use:

- Use the appliance via the SmartDevice-App or compatible EcoSystems.
- Enjoy advanced functions and settings.
- Check the current status of the appliance in the SmartDevice-App.

- The SmartDevice Box is purchased and installed (see <https://smartdevice.liebherr.com/install>).*
- The SmartDevice app is installed (see <https://apps.home.liebherr.com/>).

Setting up the connection

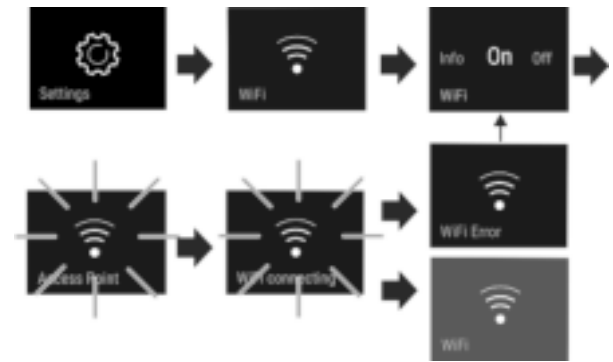

Fig. 6

- ▶ Activating the setting (see 6.2 Control concept) .
- ▷ The connection is set up: Connecting appears. The symbol flashes.
- ▷ The connection failed: WiFi Error appears.

Disconnecting the appliance

- ▶ Deactivate the setting (see 6.2 Control concept) .



Fig. 7

- ▷ There is no connection: The symbol  is displayed constantly.

Restoring the connection

- ▶ Restore settings (see 6.2 Control concept) .



Fig. 8

- ▷ Connection and other settings are restored to factory settings.



Entry lock

This setting prevents unintentional use of the appliance, e.g. by children.

Use:

- Avoid settings being changed unintentionally.
- Avoid the appliance being switched off unintentionally.
- Avoid the temperature being changed unintentionally.

Activating/deactivating settings

- ▶ Activate/deactivate (see 6.2 Control concept) .



Display brightness

Set the brightness level of the display.

You can set the following brightness levels:

- 40%
- 60%
- 80%
- 100%

Choose the setting

- ▶ Set the level (see 6.2 Control concept) .



Door alarm

Set the time before the door alarm (see Close door) sounds.

The options are as follows:

- 1 min
- 2 min
- 3 min
- Off

Choose the setting

- ▶ Set the time (see 6.5 Warnings) .



Info

This setting gives you appliance data and access to the customer menu.

It provides the following information:

- Model name
- Index
- Serial number
- Service number

Show appliance data

- ▶ Swipe in the display until Settings appears.
- ▶ Confirm the display.
- ▶ Swipe in the display until About appears.
- ▶ Read the appliance info.



SabbathMode

This setting meets the religious requirements on the Sabbath and Jewish festivals. Turn on SabbathMode to switch off certain controls. This means you can use the appliance without anyone changing the settings.

You can find a list of Star-K-certified appliances at www.star-k.org/appliances.



WARNING

Danger of food poisoning.

If there is a power cut while the appliance is in SabbathMode, this message is not saved. Once power is restored, the appliance continues in SabbathMode. When this mode is over no message about the power cut is displayed on the temperature display.

If there was a power cut during SabbathMode:

- ▶ Check the food for quality. Do not eat the food if it has thawed.

What happens on the appliance when in SabbathMode:

- The Status display permanently shows SabbathMode.
- The display is locked for all functions apart from turning off SabbathMode.
- Any functions/settings that are already on, remain active.
- The display stays bright when the door is closed.

- The reminder timings are kept.
- Reminders and warnings are not shown. There is no acoustic signal.
- The internal light is off.
- The defrost cycle only works for the specified time without taking account of fridge use.
- After a power cut the appliance automatically returns to SabbathMode.

Activating/deactivating settings

- ▶ Activating/deactivating (see 6.2 Control concept) .



CleaningMode

Use this setting to easily clean the appliance.

This setting refers to the fridge section *Fig. 1 (A)*.

Use:

- Clean the fridge section by hand.
- Clean the InfinitySpring.*

What happens on the appliance when this setting is on:

- The display permanently shows: CleaningMode.
- The fridge section is switched off.
- The internal light is on.
- Reminders and warnings are not shown. There is no acoustic signal.

Activating/deactivating settings

- ▶ Activating/deactivating the setting (see 6.2 Control concept) .

▷ On: fridge section is off. Light stays on.

▷ Off: preset temperature is restored.

After 60 min the setting turns off automatically. The appliance then continues in normal mode.



BioFresh B-Value

The temperature can be set slightly lower or higher in the BioFresh zone. The temperature can be adjusted from **B1** (lowest temperature) to **B9** (highest temperature). The default setting is **B5**. If you select a setting between **B1** and **B4**, the temperature may fall below 0 °C, causing food to become slightly frozen.

Choose the setting

- ▶ Set the size in the Customer menu (see 6.2 Control concept) .



Reminder

Reminders are displayed acoustically by a beep and visually by a symbol in the display. The signal gets louder until the alert stops.



Inserting the water tank*

This message appears when the water tank is too low.

- ▶ Fill the water tank.
- ▷ The IceMaker produces ice cubes.
- ▶ If the message still appears despite a full water tank, check if the float is stuck.
- ▶ If necessary, drain the water and release the float with a thin object such as a cotton bud.
- ▶ Contact Customer Service if the water tank is full and the message still appears (see 9.4 Customer Services) .

Features



Replace water filter*

This message appears when the water filter needs replacing.

- ▶ Change the water filter every six months
- ▶ Confirm the message to reset the maintenance interval.
- ▷ The water filter provides the best water quality.



Replace FreshAir active carbon filter

This message appears when the air filter needs replacing.

- ▶ Change the air filter every six months.
- ▶ Confirm the message to reset the maintenance interval.
- ▷ The air filter provides the best air quality in the fridge section.

Activating the setting

- ▶ Activating/deactivating (see 6.2 Control concept) .



Switching the appliance off

This setting turns off the whole appliance. The display goes dark.

Switching off the entire appliance



Fig. 9

- ▶ Activating/deactivating (see 6.2 Control concept) .

6.5 Warnings

Warnings are issued with an acoustic signal and visually with a symbol on the display. The signal gets louder until the alert stops.

6.5.1 Message



Close door

This message appears if the door is open for too long.

You can set how long it takes for this message to appear .

- ▶ Stop alarm: Confirm the message.

-or-

- ▶ Close the door.



Error

This message appears if there is a fault with the appliance. An appliance component indicates a fault.

- ▶ Open the door.
- ▶ Note down the fault code.
- ▶ Confirm the message.
- ▷ The audible signal stops.
- ▷ The display switches to the Status screen.
- ▶ Close the door.
- ▶ Contact Customer Services (see 9.4 Customer Services) .

6.5.2 DemoMode

If "D" appears on the display, demo mode is on. This option is designed for retailers, as it turns off all the cooling functions.

Stopping DemoMode

If you see the following running in the display:

- ▶ Confirm the display within the countdown.
- ▷ DemoMode is off.
- If the timer is not running:
- ▶ Unplug the appliance.
- ▶ Plug the appliance in again.
- ▷ DemoMode is off.

7 Features

7.1 4-star freezer compartment*

7.1.1 Opening/closing the freezer compartment

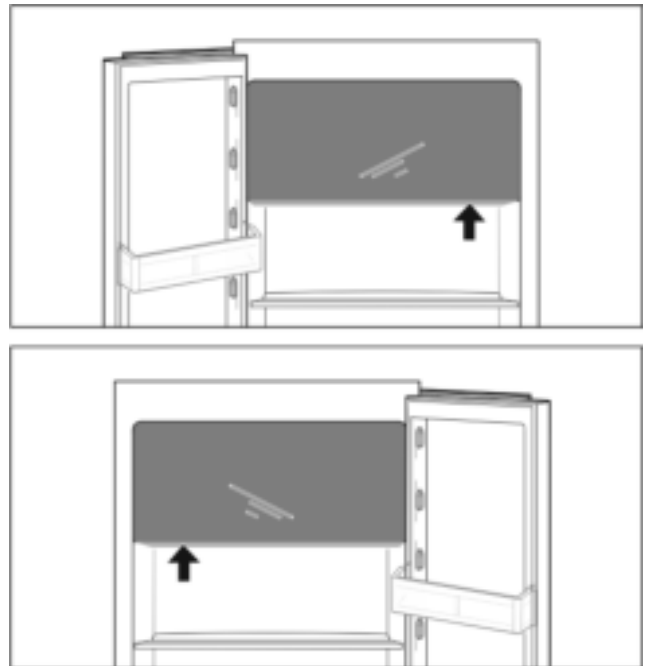

Fig. 10

Opening the freezer compartment:

- ▶ Grab the handle.
- ▶ Push the handle plate while pulling the door towards you.

Closing the freezer compartment:

- ▶ Close the door while pushing from the front.
- ▷ Door is engaged.

7.2 Door rack

7.2.1 Move/remove the door rack

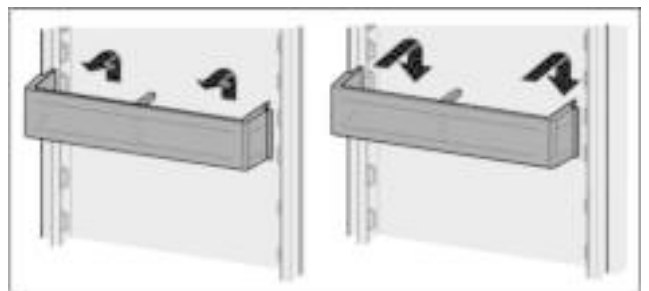

Fig. 11

- ▶ Remove the rack as per the illustration.

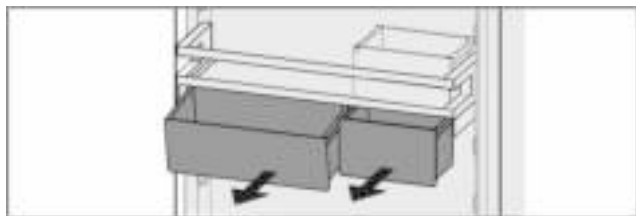

Fig. 12*

You can use just one or both VarioBoxes. To store oversized bottles, just suspend one box over the bottle rack.*

Move the VarioBox shelf:*

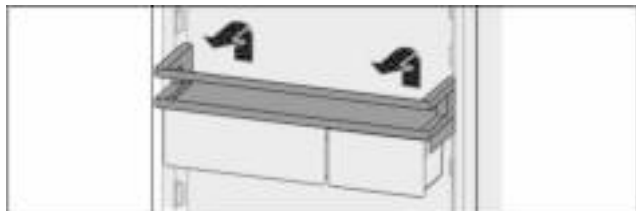

Fig. 13*

- ▶ Pull it up and out.*
- ▶ Put it back in at any position.*
- ▷ In front of 4-star freezer: Optimum air flow in the appliance is no longer guaranteed. Condensate may form on the freezer compartment.*

Note

Liebherr recommends the following:*

- ▶ Put the VarioBox shelf in its default position, anywhere below the 4-star freezer. This will provide the best air flow in the fridge section.*

Moving the VarioBoxes:*



Fig. 14*

If the door rack is removed:*

- ▶ Remove containers.*
- ▶ Move the middle holding part to where you want it.*
- ▶ Replace containers.*

7.2.2 Disassembling the door rack

The door rack can be taken apart for cleaning.

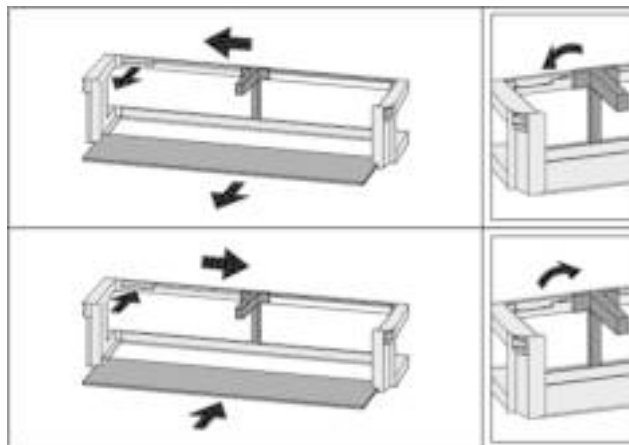

Fig. 15

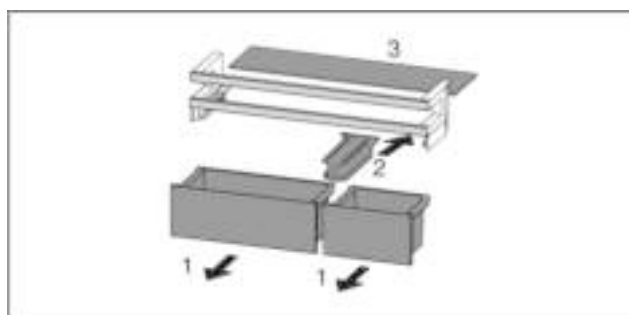

Fig. 16*

- ▶ Disassemble the door rack.

7.3 Shelves

7.3.1 Adjusting/removing the shelves

The shelves are prevented from being pulled out accidentally by pull out stops.

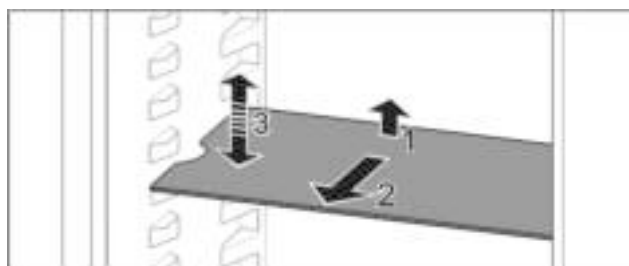

Fig. 17

- ▶ Lift the shelf and pull forward.
- ▷ Line up the side runner.
- ▶ To move a shelf: set to the position you want and slide into place.

-or-



Fig. 18

- ▶ To remove the shelf completely: pull out towards you.
- ▶ Easier removal: Set the shelf at an angle.
- ▶ To replace the shelf: push in all the way.
- ▷ The pull-out stoppers point downwards.
- ▷ The pull-out stoppers are behind the front support.

Features

7.4 Dividing shelf

7.4.1 Using the dividing shelf

The shelves are prevented from being pulled out accidentally by pull out stops.

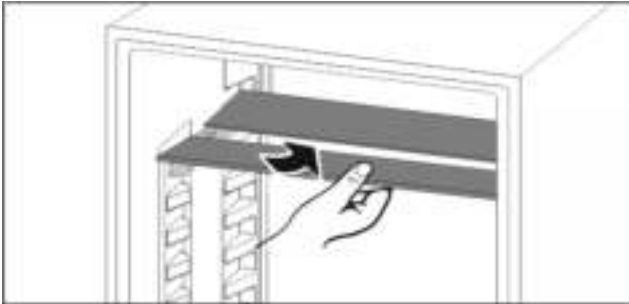

Fig. 19

- ▶ Push the dividing shelf underneath as shown.

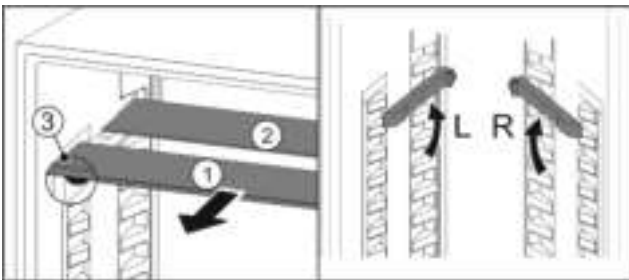

Fig. 20

Adjusting the height:

- ▶ Pull the glass panels out Fig. 20 (1) from the front, one at a time.
- ▶ Release the support rails and click in at the height you want.
- ▶ Slide in the glass panels one at a time.
- ▷ Flat pull-out stoppers at the front, right behind the support rails.
- ▷ High pull-out stoppers at the back.

Using both shelves:

- ▶ Lift the top glass plate and pull the bottom glass plate forwards.
- ▷ Glass panel Fig. 20 (1) with pull-out stoppers is at the front.
- ▷ Stoppers are pointing down Fig. 20 (3).
Appliances with freezer compartment:*
- ▶ Do not place the support rails and dividing shelf in front of the fan.*

7.5 VarioSafe*

The VarioSafe provides space for compact foodstuffs and packages, pots and glasses.

7.5.1 Using the VarioSafe

You can remove the drawer and slide it back in at 2 different heights. This is handy for storing taller items in the drawer.

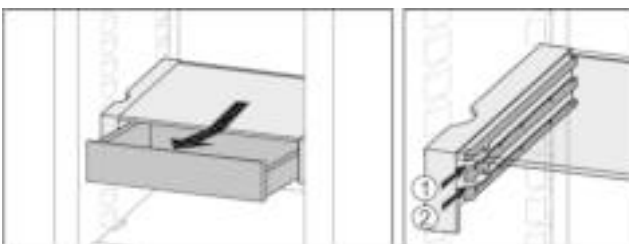

Fig. 21

- ▶ Remove the drawer.
- ▶ Slide back at the height you want Fig. 21 (1) or Fig. 21 (2).

7.5.2 Repositioning the VarioSafe

You can shift the height of the entire VarioSafe.

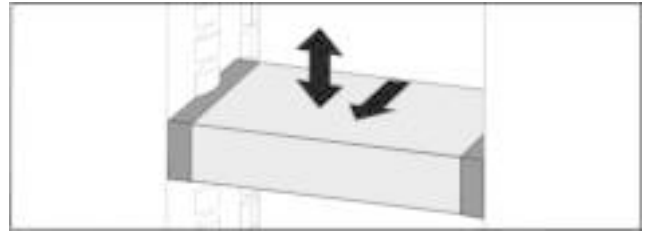

Fig. 22

- ▶ Pull forwards.
- ▷ Line up the side runner.
- ▶ Lift or lower to the height you want.
- ▶ Slide to the rear.

7.5.3 Removing the entire VarioSafe

You can remove VarioSafe as a whole unit.

- ▶ Pull forwards.
- ▷ Line up the side runner.

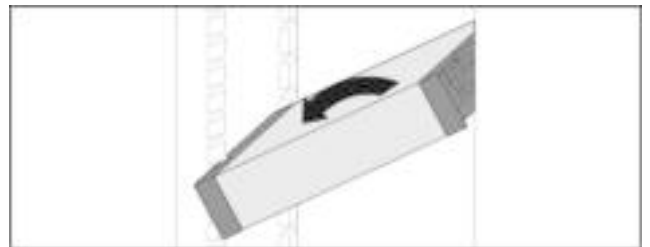

Fig. 23

- ▶ Tip to the side and pull towards you.

7.5.4 Disassembling the VarioSafe

You can take the VarioSafe apart for cleaning.

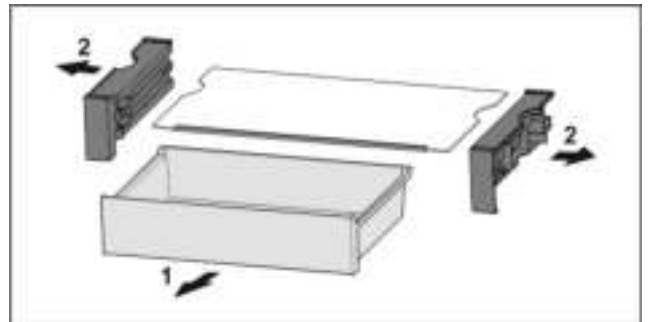

Fig. 24

- ▶ Disassembling the VarioSafe

7.6 InfinitySpring*

The built-in water dispenser is great for drinking water. The water temperature depends on the temperature in the fridge.

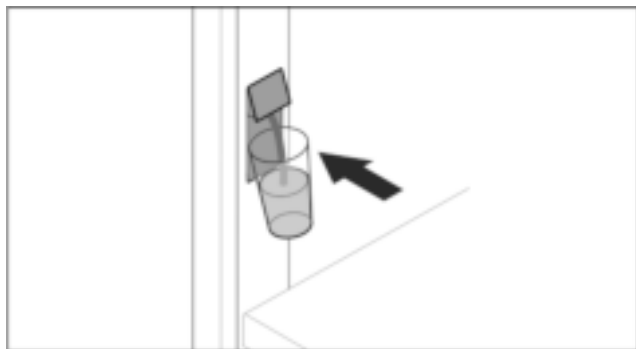

Fig. 25

- ▶ Push the glass against the bottom pushbutton of the dispenser.
- ▷ Pouring unit moves out: Water flows into the glass.
- ▶ Avoid spillages: Remove your cup slowly.
- For more water:
- ▶ If the water flow stops, remove the water tank and push your container against the bottom pushbutton of the dispenser again.

7.7 Space for baking tray

There is space for a baking tray Fig. 1 (9) above the drawers.

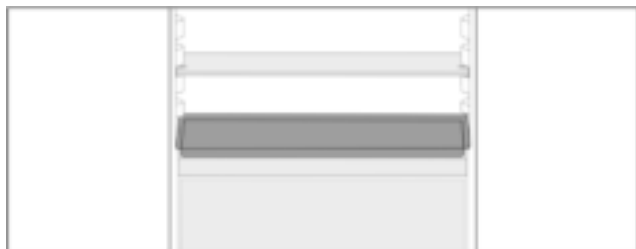

Fig. 26

Ensure that the following conditions are met:

- Max. baking tray dimensions are adhered to (see 9.1 Technical specifications).
- Baking tray is cooled to room temperature.
- The lowest door rack is set at least one position higher.

With the door open to 90°:

- ▶ Slide the baking tray onto the lower side runners.

-or-

If baking tray is uneven:

- ▶ Use the supplied support rails.

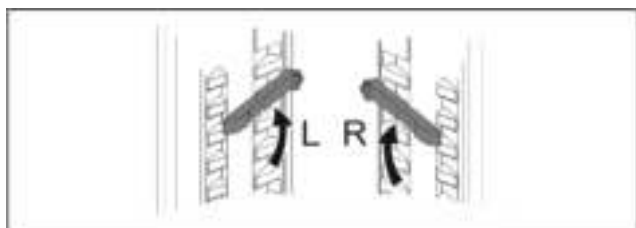

Fig. 27

- ▶ Snap support rails into the lowest runners.
- With the door open to 90°:
- ▶ Slide the baking tray in on the support rails.

7.8 Adjustable bottle shelf

7.8.1 Using the bottle shelf

In the bottom of the fridge section you can either use the variable bottle shelf or the glass panel.

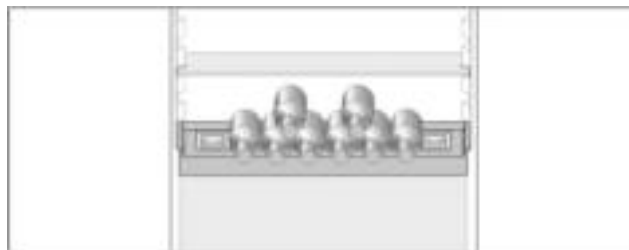

Fig. 28

- ▶ Remove the glass panel and store in a safe place.
- ▶ Lay bottles with their base towards the rear wall.

Note

- If the bottles are protruding over the front of the bottle shelf:
- ▶ Move the lower door rack up a place.

7.8.2 Removing the bottle shelf

You can remove the bottle shelf for cleaning.

- ▶ Remove the glass panel above the bottle shelf.

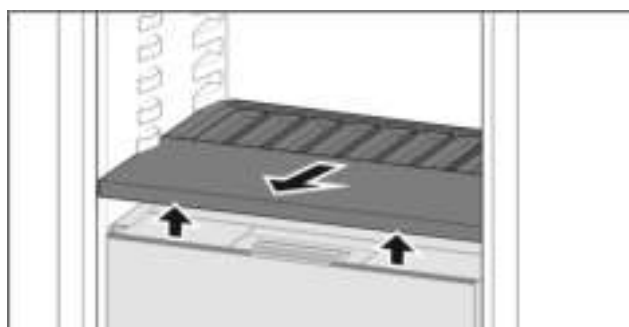

Fig. 29

- ▶ Lift the bottle shelf at the front and pull out.

Note

Liebherr recommends the following:

Do not place any goods on the drawer cover below.

7.8.3 Inserting the bottle shelf

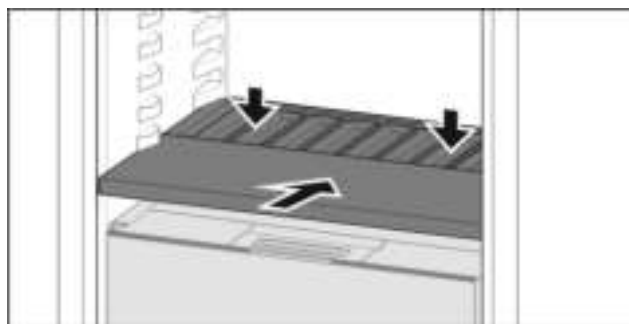

Fig. 30

- ▶ Slide in the bottle shelf until it engages and push down.
- ▷ The lugs at the back of the bottle shelf are connected automatically.
- ▷ LED comes on.

7.9 Drawers

Drawers can be removed for cleaning.

The way to remove/insert the drawers varies depending on the pull-out system. Your appliance can include various pull-out systems.

7.9.1 Removing the drawer

Drawer on retractable rails

Features

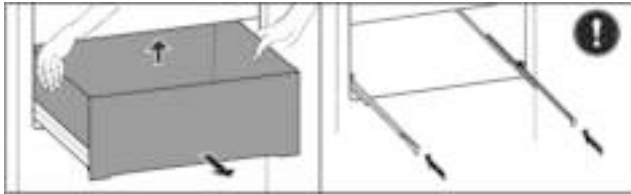

Fig. 31

- ▶ Pull out the drawer.
- ▶ Lift at the back and pull it out towards you.
- ▶ Slide the rails in.

7.9.2 Inserting the drawer

Drawer on retractable rails

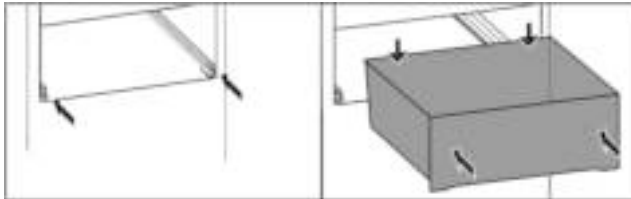

Fig. 32

The rails are inserted.:

- ▶ Slide the drawer on the rails all the way to the back.
- ▷ Clicks in at the back.

7.10 Fruit & Vegetable safe cover

You can remove the compartment cover for cleaning.

7.10.1 Removing the compartment cover

Ensure that the following conditions are met:

- Bottle shelf is removed (see 7.8 Adjustable bottle shelf) .

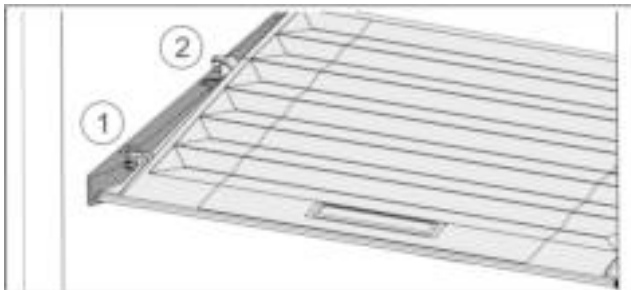

Fig. 33

When the drawers are removed:

- ▶ Pull the lid up at the front to the opening in the retaining parts Fig. 33 (1).
- ▶ Lift from the back and pull it up and out Fig. 33 (2).

7.10.2 Inserting the compartment cover

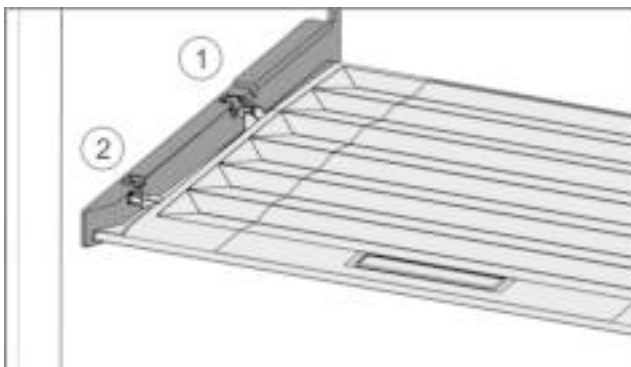

Fig. 34

- ▶ Insert the lip of the cover over the opening of the rear bracket Fig. 34 (1) and click into place Fig. 34 (2).
- ▶ Position the cover where you want it (see 7.11 Adjusting the moisture levels) .

7.11 Adjusting the moisture levels

You can adjust the moisture in the drawer yourself by adjusting the compartment cover.

The compartment lid is attached to the drawer and can be hidden by a shelf or additional drawers.

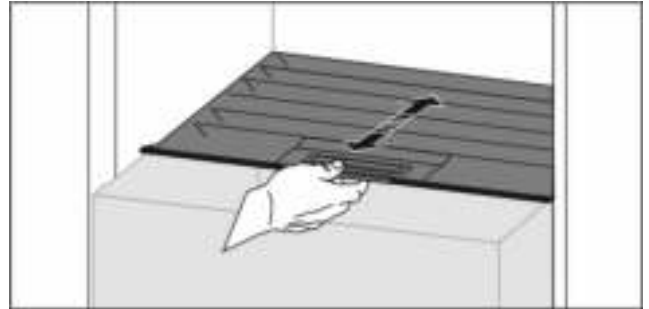

Fig. 35

Low air humidity

- ▶ Open the drawer.
- ▶ Slide the compartment cover forwards.
- ▷ With the drawer closed: Gap between the cover and the compartment.
- ▶ Switch off HydroBreeze.*
- ▷ The air moisture in the Safe decreases.

High air moisture

- ▶ Open the drawer.
- ▶ Slide the cover back.
- ▷ With the drawer closed: The cover seals the compartment.
- ▶ Activate the HydroBreeze.*
- ▷ The air moisture in the Safe increases.
- If there is too much moisture in the compartment:
- ▶ Choose the setting "low air moisture".

-or-

- ▶ Remove any excess moisture with a cloth.

Note

You can apply the "low air moisture" setting to the Fruit & Vegetable-Safe and the Meat & Dairy-Safe.

- ▶ Set the "low air moisture" option.

7.12 HydroBreeze*

HydroBreeze emits a mist over the refrigerated goods to provide moisture every time the door is opened.

The HydroBreeze and its water tank are located in the adjustable bottle shelf.

Ensure that the following conditions are met:

- The water tank is clean (see 8.3.3 Clean the components) .
- The water tank is properly engaged.
- Moisture is set to "high moisture" (see 7.11 Adjusting the moisture levels) .
- HydroBreeze is on (see HydroBreeze*) .

7.12.1 Fill the water tank



WARNING

Unclean water!
Contaminants.

- ▶ Only fill with drinking water.
- ▶ The HydroBreeze is off: empty water tank.
- ▶ The HydroBreeze is no longer in use: empty water tank.

NOTICE

Sugar-content liquids!
Damage to HydroBreeze.

- ▶ Only fill with drinking water.

Note

Only use filtered, decarbonised water for the best quality drinking water and to make the HydroBreeze, work smoothly. This water quality can be achieved using a table water filter of the kind available in trade retail outlets.

- ▶ Only ever fill the water tank with filtered, decarbonised drinking water.

The water tank is built into the adjustable bottle shelf (see 1.2 Overview of the appliance and its equipment) .

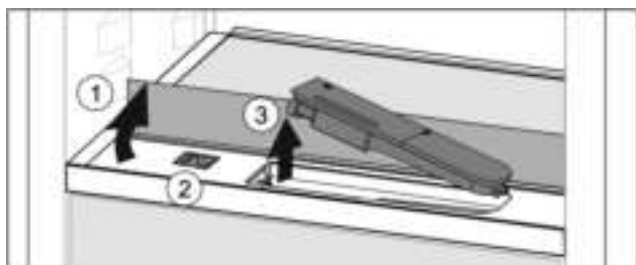

Fig. 36

- ▶ Press on the back-left corner of the front glass plate.
- ▷ The glass panel folds up at the front.
- ▶ Lift the glass panel and fold towards the rear until it clicks into place Fig. 36 (1).
- ▷ Glass panel stands upright.
- ▶ Slide the slider Fig. 36 (2) to the left.
- ▷ The water tank jumps out of its recess.
- ▶ Remove the water tank Fig. 36 (3).
- ▶ Cleaning the water tank (see 8.3.3 Clean the components) .
- Square opening:
- ▶ Fill with drinking water up to the marker.
- ▶ Insert the water tank into the recess, bottom first.
- ▶ Slowly lower the front part and push the tank in.
- ▷ The water tank is clicked into place.

7.12.2 Dismantling the water tank

You can take the water tank apart for cleaning.

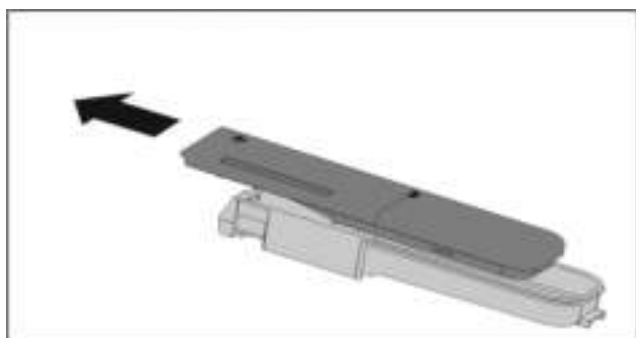

Fig. 37

- ▶ Dismantling the water tank.

7.13 Accessories

7.13.1 Butter dish

Opening/closing the butter dish

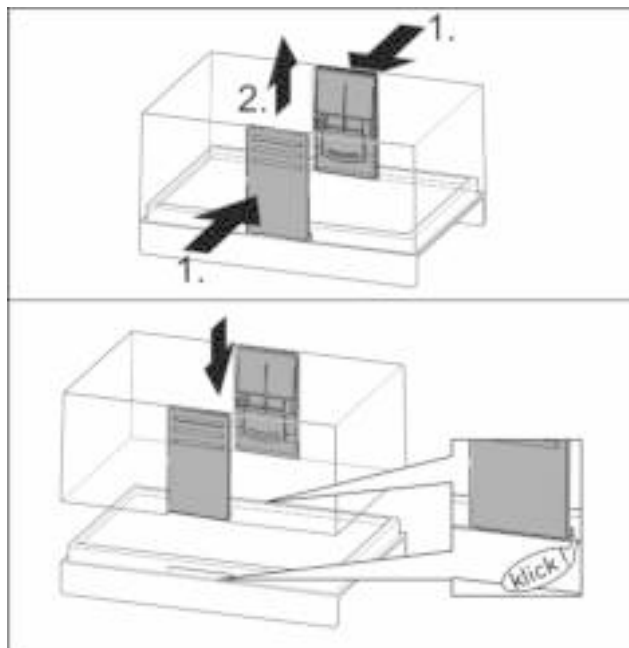

Fig. 38

Dismantling the butter dish

You can take the butter dish apart for cleaning.

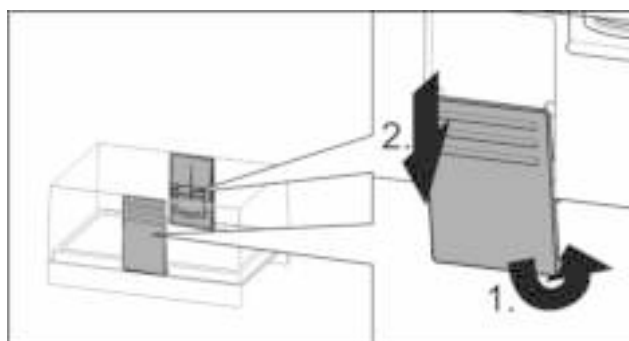

Fig. 39

- ▶ Dismantling the butter dish.

7.13.2 Egg rack

You can pull out and turn the egg rack. You can use both sides of the egg rack so you can label specifics like the purchase date.

Features

Using the egg rack

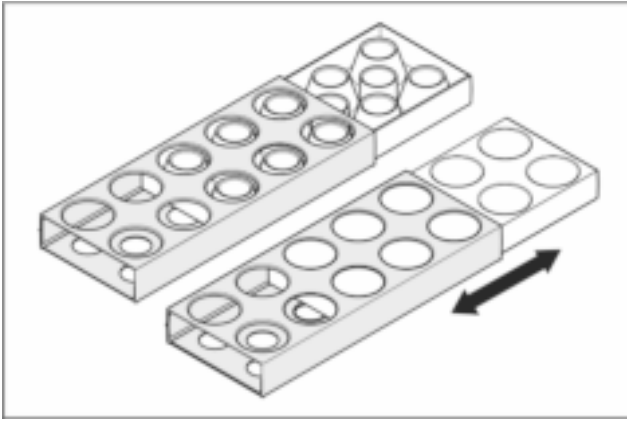

Fig. 40

- ▶ Top layer: for storing hen eggs.
- ▶ Bottom layer: for storing quail eggs.

7.13.3 Bottle holder

Using the bottle holder

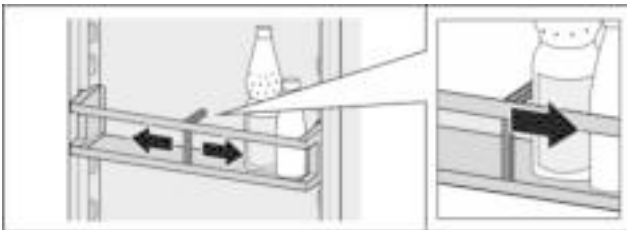

Fig. 41

- ▶ Push the bottle holder onto the bottles.
- ▷ The bottles are prevented from falling over.

Removing the bottle holder

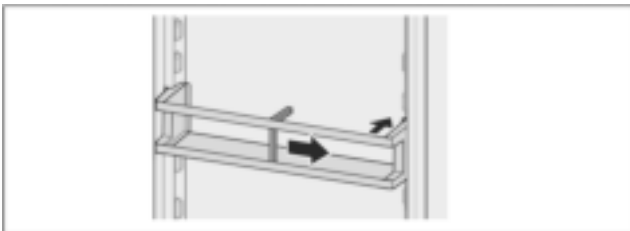

Fig. 42

- ▶ Move the bottle holder all the way to the right.
- ▶ Push the bottle holder to the back to remove.

7.13.4 FlexSystem*

Using the FlexSystem

The FlexSystem helps you store and organise your food in a clear and flexible way. It lets you clearly divide your food into fruit, vegetables or by use-by dates, for example.

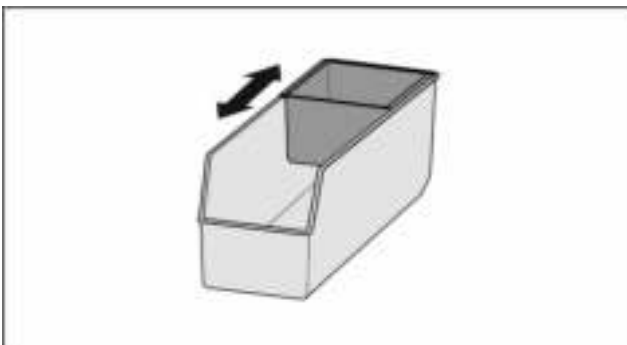

Fig. 43

- ▶ Move the inner shell.

Removing the FlexSystem

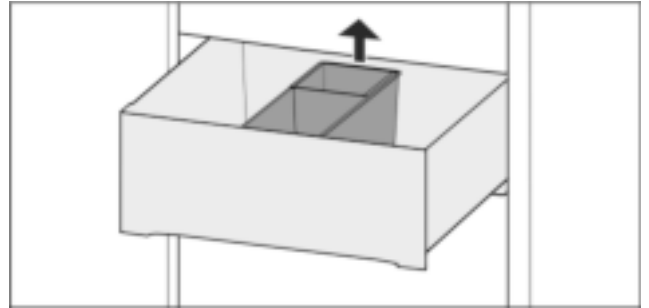

Fig. 44

- ▶ Lift the FlexSystem from the back.
- ▶ Pull up and out.

Inserting the FlexSystem

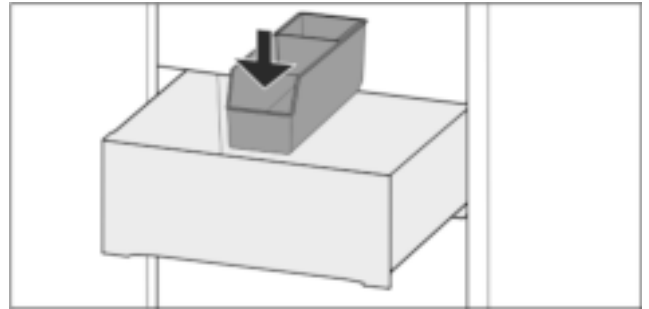

Fig. 45

- ▶ Insert the FlexSystem front-first.
- ▶ Lower the rear part.

Disassembling the FlexSystem

You can take the FlexSystem apart for cleaning.

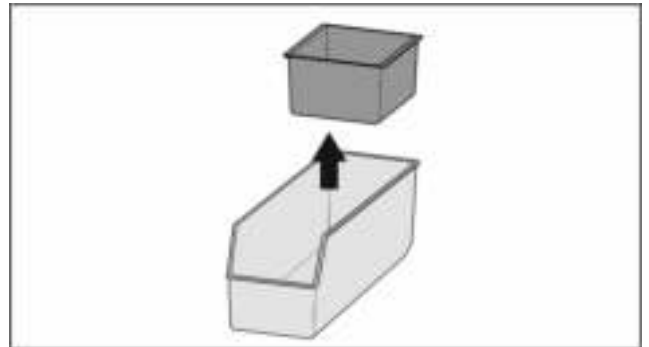

Fig. 46

- ▶ Disassembling the FlexSystem

7.13.5 Ice cube tray with cover*

Using the ice cube tray

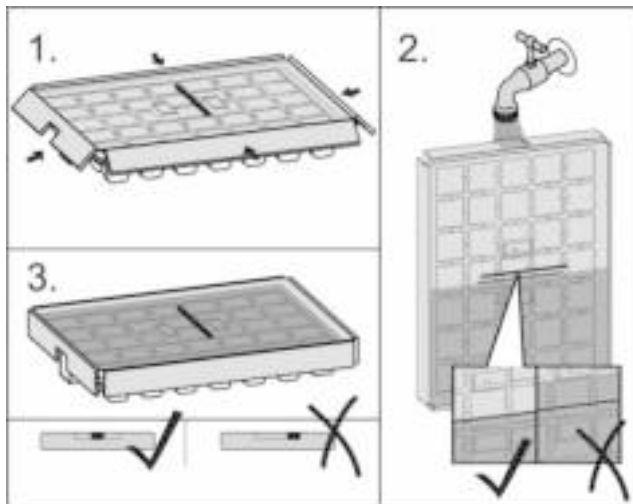

Fig. 47

When the water is frozen:

- ▶ Hold ice cube tray under hot water for a short time.
- ▶ Remove the lid.
- ▶ Gently turn the ends of the ice cube tray in opposite directions.
- ▶ Release the ice cubes.

Dismantling the ice cube tray

You can take the ice cube tray apart for cleaning.

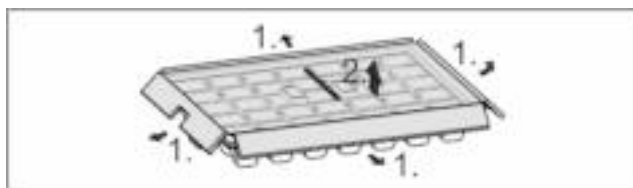

Fig. 48

- ▶ Disassembling the ice cube tray.

8 Maintenance

8.1 FreshAir carbon filter

The FreshAir carbon filter is in the compartment above the fan. It guarantees the best air quality.

- Replace the carbon filter every 6 months.
With the *Reminder* setting on, a message on the display prompts you to replace it.
- The carbon filter can be disposed of with the regular household waste.

Note

You can purchase the FreshAir carbon filter from the [Liebherr household appliance store](http://home.liebherr.com) (home.liebherr.com).

8.1.1 Removing the FreshAir carbon filter

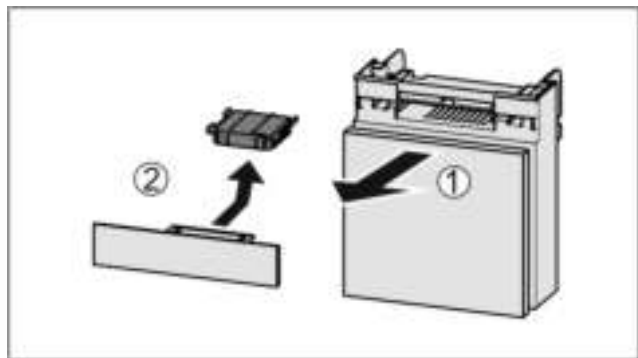

Fig. 49

- ▶ Pull out the compartment Fig. 49 (1).
- ▶ Remove the carbon filter Fig. 49 (2).

8.1.2 Inserting the FreshAir carbon filter

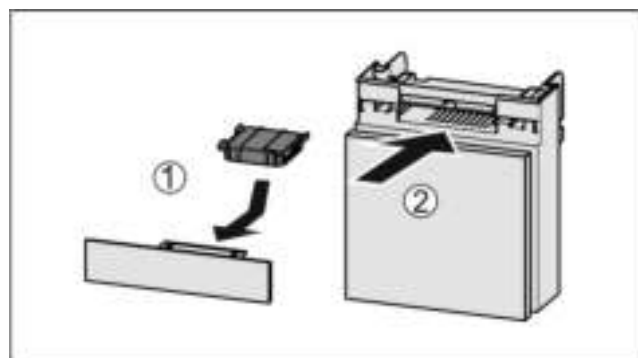

Fig. 50

- ▶ Insert the carbon filter as shown in the diagram Fig. 50 (1).
- ▷ The carbon filter clicks into place.
- If the carbon filter is pointing downwards:
 - ▶ Push the compartment in Fig. 50 (2).
 - ▷ The carbon filter is now ready for use.

8.2 Defrosting the appliance



WARNING

Improper defrosting of the appliance!
Injuries and damage.

- ▶ Never use mechanical aids or other means that have not been recommended by the manufacturer, to speed up the defrosting process.
- ▶ Do not use electrical heating or steam-cleaning appliances, naked flames or defroster sprays to defrost.
- ▶ Do not use sharp objects to remove ice.
- ▶ Do not damage the pipework in the cooling circuit.

Defrosting is automatic. The thawing water drains through the outlet and evaporates.

- ▶ Clean the outflow opening regularly (see 8.3 Cleaning the appliance).

8.2.2 Defrost the freezer compartment manually

After prolonged use, a layer of frost or ice can form.

The following factors promote the formation of frost or ice:

- Appliance is frequently opened.
- Hot food was put in.
- ▶ Turn off the appliance (see 6.4 Settings).
- ▶ Pull out the power plug or switch off the fuse.

Maintenance

- ▶ Wrap the frozen produce in newspaper or blankets and store in a cool place.
- ▶ Place a pan of hot, non-boiling water on the middle shelf.

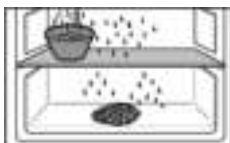

- ▷ This speeds up the defrosting process.
- ▶ Leave the compartment and appliance door open during defrosting.*
- ▶ Remove detached pieces of ice.
- ▶ Make sure that there is no thaw water in the cabinet.
- ▶ Keep absorbing the thawed water with a sponge or cloth.
- ▶ Clean the appliance (see 8.3 Cleaning the appliance) .

8.3 Cleaning the appliance

8.3.1 Ready



WARNING

Danger of electric shock!

- ▶ Remove the refrigerator connector or interrupt the power supply.



WARNING

Risk of fire

- ▶ Do not damage the refrigeration circuit.

- ▶ Empty the appliance.

8.3.2 Cleaning the interior

NOTICE

Improper cleaning!

Damage to the appliance.

- ▶ Only use soft cleaning cloths and ph-neutral all-purpose cleaners.

Plastic surfaces:

- ▶ Clean by hand with a soft, clean cloth, lukewarm water and a little detergent.

Metal surfaces:

- ▶ Clean by hand with a soft, clean cloth, lukewarm water and a little detergent.

To clean the outlet *Fig. 1 (14)*:

- ▶ Remove any deposits with a thin item such as a cotton bud.

Remove stainless steel back panel:

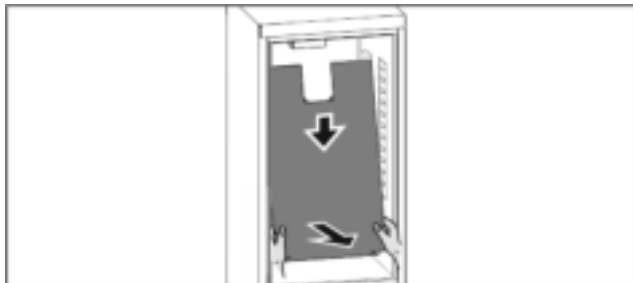

Fig. 51

You can remove the stainless steel back wall for cleaning.

With all equipment parts removed:

- ▶ Hold the back wall at the bottom with both hands and pull down forcefully at the same time.
- ▶ Pull the back wall down and out.
- ▷ The back wall is removed.
- If the appliance is still used with the rear wall removed:
- ▶ Set the *D-Value* to D2 .

Insert the stainless steel back panel:



Fig. 52

With all equipment parts removed:

- ▶ Slide the back panel from bottom to top.
- If the rear wall is inserted in the upper gap:
- ▶ Push the back panel on the left side forcefully backwards.
- ▷ Back wall snaps into place.
- ▶ Set the *D-Value* to D1 .

8.3.3 Clean the components

NOTICE

Improper cleaning!

Damage to the appliance.

- ▶ Only use soft cleaning cloths and ph-neutral all-purpose cleaners.

Clean with a soft, clean cloth, lukewarm water and some detergent:

- Water tray
- VarioSafe*
- Fruit & Vegetable safe cover
- Drawer
- Adjustable bottle shelf
- FlexSystem*

Clean with a damp cloth:

- Retractable rails
- Please note: The grease in the tracks is used for lubrication and must not be removed!

Wash in the dishwasher up to 60 °C:

- Door rack
- VarioBox*
- Bottle rack
- Shelf
- Dividing shelf
- Holder of the dividing shelf
- HydroBreeze water tank and water tank lid*
- Egg rack
- Butter dish
- Ice cube tray*

- ▶ To disassemble components: see the relevant section.

- ▶ Clean the components.

8.3.4 Cleaning the InfinitySpring*

You can clean the InfinitySpring outlet and around it without disconnecting the appliance from the mains.

Cleaning is required in the following cases:

- Initial operation
- If out of use for more than 5 days.
- ▶ Press the bottom pushbutton of the dispenser.
- ▷ The outlet unit moves out.
- ▶ Clean the water outlet and around it with a soft, clean cloth, lukewarm water and some detergent.
- ▶ Release the bottom pushbutton.
- ▶ Draw 2 l of water from the InfinitySpring and dispose of it.*

8.3.5 Cleaning the HydroBreeze*

Cleaning is required in the following cases:

- Initial operation
- HydroBreeze is off for more than 48 hours.
- Refill the water tank.

Ensure that the following conditions are met:

- HydroBreeze is off (see HydroBreeze*).
- Water tank has been removed and cleaned in the dishwasher.
- ▶ Wipe out the recess with a damp cloth.
- ▶ Insert the water tank.
- ▶ Activate the HydroBreeze.

8.3.6 After cleaning

- ▶ Wipe the appliance and the components dry.
- ▶ Connect and switch on the appliance.
The temperature is cold enough:
- ▶ Place the food inside.
- ▶ Repeat cleaning regularly.

9 Customer help

9.1 Technical specifications

Temperature range	
Cooling	3 °C to 9 °C
BioFresh	0 °C to 3 °C

Maximum freezer quantity / 24 hrs	
Freezer compartment*	See the type plate under "Freezer goods ... /24 hours**"

Maximum size baking tray	
Width	466 mm
Depth	386 mm
Height	50 mm

Lighting	
Class ¹	Light source
This product contains a light source that meets energy efficiency rating F	LED

¹ The appliance may contain light sources with different energy efficiency classes. The lowest class is given here.

9.2 Operating noises

The appliance makes different noises when it is on.

- At **higher temperatures** the appliance uses less energy but works for longer. It is **quieter**.
- At **lower temperatures** the food is cooled faster. It is **louder**.

Defect	Cause	Remedy
The appliance is not working.	→ The appliance is not switched on.	▶ Switch the appliance on.
	→ The power plug is not properly plugged into the socket.	▶ Check the power plug.
	→ There is something wrong with the power outlet fuse.	▶ Check the fuse.

Examples:

- Functions on (see 6.3 Functions)
- Fan running
- Food recently added
- High ambient temperature
- Door open for a while

Noise	Possible cause	Type of noise
Bubbling splashing and	Coolant flowing into the cooling circuit.	Normal operating noise
Hissing	Coolant sprays into the cooling circuit.	Normal operating noise
Humming	The appliance is cooling. The volume depends on the cooling output.	Normal operating noise
Suction noises	Soft-closing door is being opened and closed.	Normal operating noise
Humming rustling and	The fan is running.	Normal operating noise
Clicking	Components turning on and off	Normal switching noise
Rattling humming or	Valves or flaps are working.	Normal switching noise

Noise	Possible cause	Type of noise	Lifting
Vibration	Improper installation.	Defective noise	Check the installation. Level the appliance.
Rattling	Components, items inside the appliance	Defective noise	Secure components. Leave enough space between the items.

9.3 Technical fault

Your appliance is designed and built to ensure it works reliably and has a long service life. In the unlikely event that a fault occurs during operation, please check whether it is due to an operating error. If so, you will be charged for the callout and repair costs even if it falls within the warranty period.

You can fix the following faults yourself.



9.3.1 Appliance function

Customer help

Defect	Cause	Remedy
	→ Power cut	<ul style="list-style-type: none"> ▶ Keep the appliance closed. ▶ Protecting food: Lay freezer packs on top of the food or use another freezer if the power is off for a prolonged period. ▶ Do not re-freeze defrosted food,
	→ The appliance plug does not fit the appliance properly.	▶ Check the appliance plug.
Temperature is not cold enough.	→ The appliance door is not closed properly.	▶ Close the appliance door.
	→ Not enough ventilation.	▶ Keep ventilation grille clear, and clean it.
	→ The ambient temperature is too high.	▶ Solution: (see 1.3 Appliance range of use) .
	→ The appliance was opened too many times or for too long.	▶ Wait to see if the required temperature corrects itself. If not, contact Customer Service (see 9.4 Customer Services) .
	→ The appliance is too close to a heat source (oven, radiator, etc).	▶ Move the appliance or the heat source.
	→ The appliance was not correctly installed in the recess.	▶ Check if the appliance was installed correctly and that the door closes properly.
The door seal is defective or needs to be replaced for another reason.	→ The door seal can be replaced. It can be replaced without the need for special tools.	▶ Contact Customer Services (see 9.4 Customer Services) .
The appliance builds up too much ice or condensation.	→ The door seal may have slipped out of its groove.	▶ Check that the door seal is well fitted in the groove.

9.3.2 Features

Defect	Cause	Remedy
The InfinitySpring is not working.*	→ There is air in the water system.	▶ Vent the water system (see the Installation Instructions, Water Connection).
	→ The water connection is not open.	▶ Open the water connection.*
The water flow through the InfinitySpring is irregular.*	→ The aerator is dirty.	▶ Replace the aerator. Contact Customer Services (see 9.4 Customer Services) .
HydroBreeze is not keeping refrigerated goods moist.*	→ The HydroBreeze is not on.	▶ Activate the HydroBreeze.
	→ There is not enough water in the water tank.	▶ Fill the water tank.
	→ There is dirt in front of the concentrator.	▶ Clean the HydroBreeze.
	→ The water tank is not clicked into place properly.	▶ Click the water tank into place.
	→ The cover of the Fruit & Vegetable-Safe is in "low air moisture" mode.	▶ Set the Fruit & Vegetable-Safe to the "high air moisture" mode.
The internal light does not come on.	→ The appliance is not switched on.	▶ Switch the appliance on.
	→ The door was open for longer than 15 minutes.	▶ Interior lighting turns off automatically after approx. 15 min. with the door open.

Defect	Cause	Remedy
	→ The LED light is faulty or the cover is damaged:	 WARNING Risk of injury due to electric shock! There are live electrical parts under the cover. ► Only ever have the inside LED light replaced or repaired by customer service or trained personnel.
		 WARNING Risk of injury from LED bulb! The light intensity of the LED light corresponds to hazard group RG 2. If the cover is defective: ► Do not look directly into the light from close range. It cause injury to the eyes.
The freezer compartment cannot be closed.*	→ The lock is on when the door is open.	► Use the handle again.

9.4 Customer Services

First check if you can fix the error yourself (see 9 Customer help) . If you can't, contact Customer Services.

Please refer to the enclosed "Liebherr-Service" brochure for the address.



WARNING

Risk of injury if repair work is not carried out professionally!

- Have any repairs and action - not expressly specified - on the appliance and mains cable carried out by service personnel only. (see 8 Maintenance)

9.4.1 Contact Customer Services

Make sure you have the following appliance data at the ready:

- Appliance name (model and index)
- Service no. (Service)
- Serial no. (S no.)
- Look up the appliance information on the display (see Info) .
- or-**
- Referring to appliance info on the nameplate (see 9.5 Model plate) .
- Note down the appliance information.
- Notify Customer Services of the following: Give us the appliance data.
- ▷ This will help us to provide you with a faster, more accurate service.
- Follow any further instructions given by Customer Services.

9.5 Model plate

The model plate is behind the drawers on the inside of the appliance.



Fig. 53

- (1) Appliance description
- (2) Service no.
- (3) Serial no.
- Note the data on the model plate.

10 Shutting down

- Empty the appliance.
- Turn off the appliance (see 6.4 Settings) .
- Remove mains connector.
- Remove appliance connector if required: Remove and move from left to right at the same time.
- Clean the appliance (see 8.3 Cleaning the appliance) .
- Leave the door open to avoid bad smells building up.

11 Disposing of the appliance

The appliance contains some reusable materials and should be disposed of properly - not simply with unsorted household refuse. Appliances which are no longer needed must be disposed of in a professional and appropriate way, in accordance with the current local regulations and laws.



Do not damage the disused appliance while removing it from the cooling circuit, in case the coolant (information on the model plate)) or oil inside leaks out.

For Germany:

The appliance can be disposed of free of charge in Class 1 collection containers at your local recycling centre. When purchasing a new fridge/freezer and if your sales area is > 400 m², the retailer will also take back the old appliance free of charge.

Decommission the appliance:

- Pull out the plug.

Disposing of the appliance

- ▶ Remove the connection cable from the appliance.



home.liebherr.com/fridge-manuals

EN integrated fridge with BioFresh

Issue date: 20210309
Part number index: 7088276-00

Liebherr-Hausgeräte Ochsenhausen GmbH
Memminger Straße 77-79
88416 Ochsenhausen
Deutschland