

4. Select size

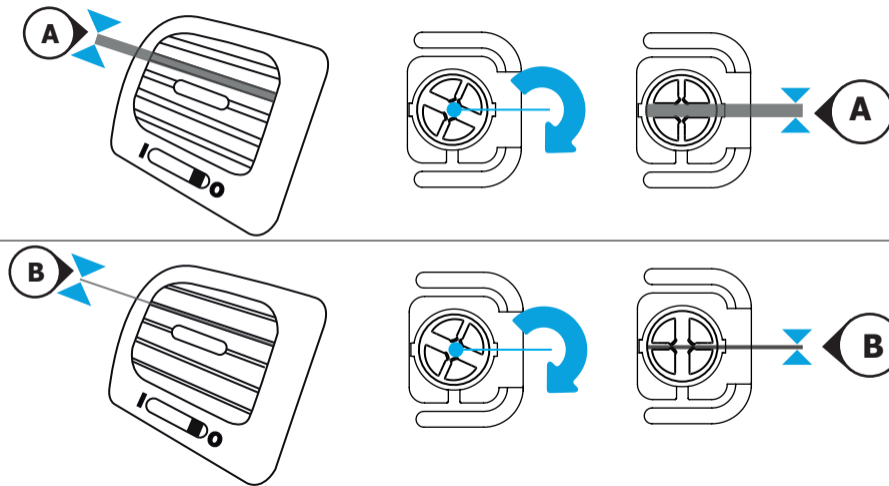

5. Plug in

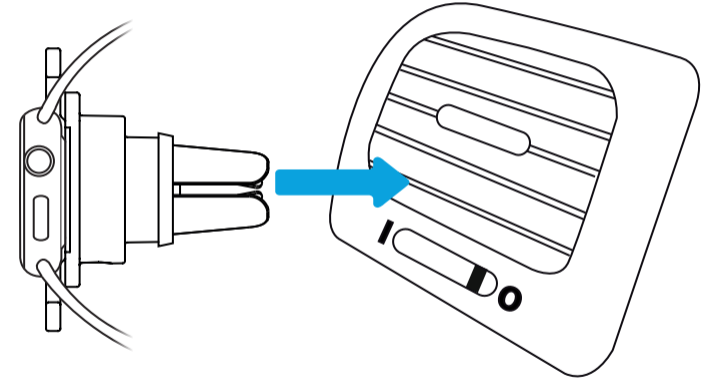

6. Remove charge cable

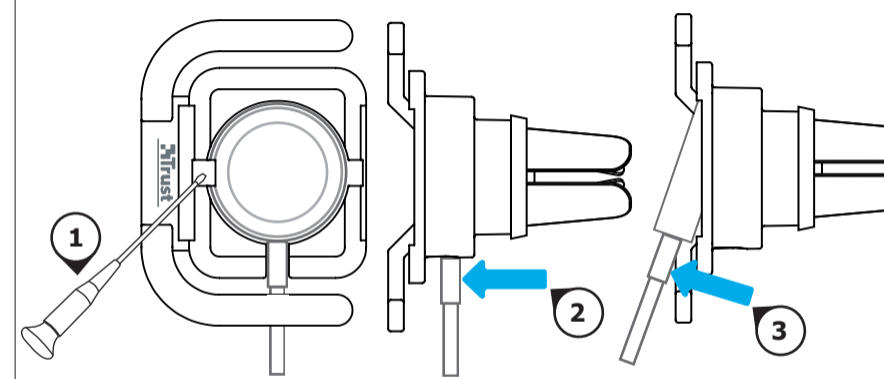

Frequently Asked Questions

<http://www.trust.com/20921/faq> (38 mm)

<http://www.trust.com/20935/faq> (42 mm)

© 2016 Trust International B.V. - All rights reserved
Laan van Barcelona 600
3317DD, Dordrecht, NL

Trust
URBAN

Quick Installation Guide

Charging Car Holder for Apple Watch 38/42mm



1A. Apple Watch Sport



*Apple wireless charger not included

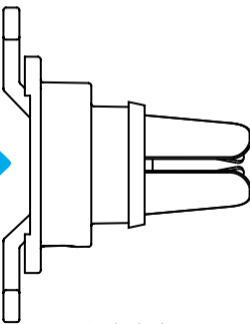

1B. Apple Watch



*Apple wireless charger not included

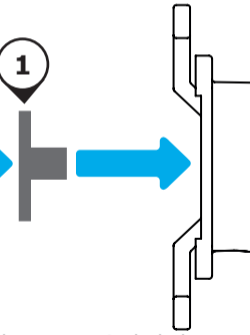

1

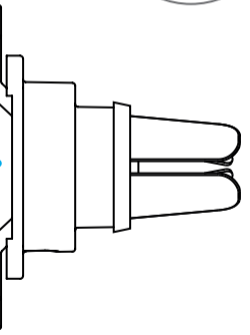

2



2. Insert charge cable & watch

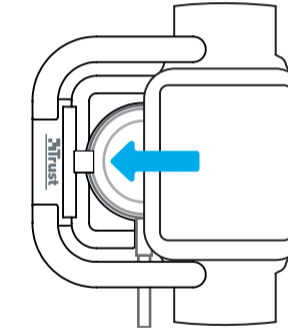
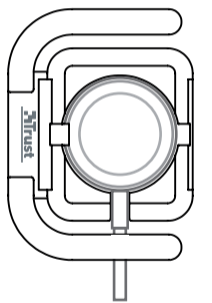
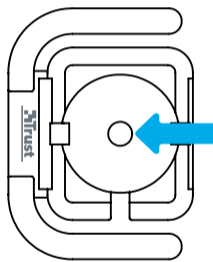

3. Air vent off

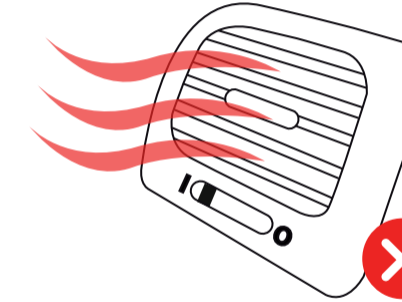

OFF