

Nikon

with **WARRANTY**

DIGITAL CAMERA

Z 50

User's Manual (with Warranty)

- Read this manual thoroughly before using the camera.
- To ensure proper use of the camera, be sure to read "For Your Safety" (page x).
- After reading this manual, keep it in a readily accessible place for future reference.

En

Package Contents

Be sure all items listed here were included with your camera.



BF-N1 body cap



*DK-30 rubber eyecup
(comes attached to
camera)*

Camera

*EN-EL25 rechargeable Li-ion
battery with terminal cover*

*MH-32 battery charger (plug
adapter supplied in countries or
regions where required; shape
depends on country of sale)*

AN-DC20 strap (□ 9)

*Warranty (printed on the back
cover of this manual)*

User's Manual

UC-E21 USB cable

Memory cards are sold separately. Purchasers of the lens kit option should confirm that the package also includes a lens (manuals for the lens may also be provided).

The Nikon Download Center

A pdf version of this manual is available from the Nikon Download Center, together with an English-language reference manual with detailed operating instructions, which can be downloaded in pdf format or viewed online in html. Visit the Nikon Download Center to download firmware updates, ViewNX-i and other Nikon computer software, and manuals for other Nikon products including cameras, NIKKOR lenses, and flash units.

<https://downloadcenter.nikonimglib.com/>

Z 50 Model Name: N1912

About This Manual

Symbols and Conventions

To make it easier to find the information you need, the following symbols and conventions are used:



This icon marks notes, information that should be read before using this product.



This icon marks tips, additional information you may find helpful when using this product.



This icon marks references to other sections in this manual.

Menu items, options, and messages that appear in the camera displays are shown in **bold**. Throughout this manual, the display in camera monitor and viewfinder during shooting is referred to as the “shooting display”; in most cases, the illustrations show the monitor.

This camera uses SD, SDHC, and SDXC memory cards, referred to throughout this manual as “memory cards”.

Throughout this manual, smartphones and tablets are referred to as “smart devices”.

Camera Settings

The explanations in this manual assume that default settings are used.

For Your Safety

Before using the camera for the first time, read the safety instructions in “For Your Safety” (□ x).

Nikon User Support

Visit the site below to register your camera and keep up-to-date with the latest product information. You will find answers to frequently asked questions (FAQs) and can contact us for technical assistance.

<https://www.europe-nikon.com/support>

Table of Contents

Package Contents	ii
Menu List	vi
For Your Safety	x
Notices.....	xiv
Getting to Know the Camera	1
<hr/>	
Parts of the Camera	1
Camera Body	1
The Monitor and Viewfinder.....	5
The MENU Button.....	7
First Steps	9
<hr/>	
Attach the Camera Strap	9
Charge the Battery.....	10
The Battery Charger.....	10
Insert the Battery and a Memory Card.....	11
Attach a Lens.....	15
Turn the Camera On	17
Basic Photography and Playback	18
<hr/>	
Taking Photographs (AUTO Mode)	18
Shooting Movies (AUTO Mode).....	22
Basic Playback.....	24
Viewing Movies	24
Deleting Unwanted Pictures	26

Caring for the Camera and Battery: Cautions.....	27
Specifications.....	32
Approved Memory Cards	43
Battery Endurance	44
NIKKOR Z DX 16–50mm f/3.5–6.3 VR Lens	45
NIKKOR Z DX 50–250mm f/4.5–6.3 VR Lens	47
Notices.....	50
Bluetooth and Wi-Fi (Wireless LAN).....	51
Trademarks and Licenses	56
Warranty Terms - Nikon Europe Service Warranty	61

Menu List

The camera offers the following menus. For a more complete description of individual menu items, refer to the “Menu Guide” chapter in the *Reference Manual*.

PLAYBACK MENU

- Delete
- Playback folder
- Playback display options
- Image review
- After delete
- Rotate tall
- Slide show
- Rating

PHOTO SHOOTING MENU

- Reset photo shooting menu
- Storage folder
- File naming
- Choose image area
- Image quality
- Image size
- NEF (RAW) recording
- ISO sensitivity settings
- White balance
- Set Picture Control
- Manage Picture Control
- Color space

PHOTO SHOOTING MENU

- Active D-Lighting
- Long exposure NR
- High ISO NR
- Vignette control
- Diffraction compensation
- Auto distortion control
- Flicker reduction shooting
- Metering
- Flash control
- Flash mode
- Flash compensation
- Release mode
- Focus mode
- AF-area mode
- Optical VR
- Auto bracketing
- Multiple exposure
- HDR (high dynamic range)
- Interval timer shooting
- Time-lapse movie
- Silent photography

MOVIE SHOOTING MENU

Reset movie shooting menu

File naming

Frame size/frame rate

Movie quality

Movie file type

ISO sensitivity settings

White balance

Set Picture Control

Manage Picture Control

Active D-Lighting

High ISO NR

Vignette control

Diffraction compensation

Auto distortion control

Flicker reduction

Metering

Release mode (save frame)

Focus mode

AF-area mode

Optical VR

Electronic VR

Microphone sensitivity

Attenuator

Frequency response

Wind noise reduction

CUSTOM SETTING MENU

Reset custom settings

a Autofocus

a1 AF-C priority selection

a2 Auto-area AF face/eye
detection

a3 Focus points used

a4 AF activation

a5 Focus point wrap-around

a6 Focus point options

a7 Low-light AF

a8 Built-in AF-assist
illuminatora9 Manual focus ring in AF
mode

b Metering/exposure

b1 EV steps for exposure cntrl

b2 Easy exposure
compensation

b3 Center-weighted area

b4 Fine-tune optimal
exposure

c Timers/AE lock

c1 Shutter-release button
AE-L

c2 Self-timer

c3 Power off delay

CUSTOM SETTING MENU

d Shooting/display

- | | |
|-----|-----------------------------|
| d1 | CL mode shooting speed |
| d2 | Max. continuous release |
| d3 | Exposure delay mode |
| d4 | Shutter type |
| d5 | Limit selectable image area |
| d6 | File number sequence |
| d7 | Apply settings to live view |
| d8 | Framing grid display |
| d9 | Peaking highlights |
| d10 | View all in continuous mode |

e Bracketing/flash

- | | |
|----|--|
| e1 | Flash sync speed |
| e2 | Flash shutter speed |
| e3 | Exposure comp. for flash |
| e4 | Auto  ISO sensitivity control |
| e5 | Bracketing order |

CUSTOM SETTING MENU

f Controls

- | | |
|----|--|
| f1 | Customize  menu |
| f2 | Custom controls (shooting) |
| f3 | Custom controls (playback) |
| f4 | Customize command dials |
| f5 | Release button to use dial |
| f6 | Reverse indicators |

g Movie

- | | |
|----|--|
| g1 | Customize  menu |
| g2 | Custom controls |
| g3 | AF speed |
| g4 | AF tracking sensitivity |
| g5 | Highlight display |

SETUP MENU

Format memory card
Save user settings
Reset user settings
Language
Time zone and date
Monitor brightness
Viewfinder brightness
Viewfinder color balance
Information display
AF fine-tune
Image Dust Off ref photo
Image comment
Copyright information
Beep options
Touch controls
Self-portrait mode
HDMI
Location data display
Airplane mode
Connect to smart device
Connect to PC
Wireless remote (ML-L7) options
Conformity marking
Energy saving
Slot empty release lock
Reset all settings
Firmware version

RETOUCH MENU

NEF (RAW) processing
Trim
Resize
D-Lighting
Quick retouch
Red-eye correction
Straighten
Distortion control
Perspective control
Image overlay
Trim movie
Side-by-side comparison*

MY MENU

Add items
Remove items
Rank items
Choose tab

* Can only be displayed by pressing **i** and selecting **Retouch** when a retouched image or original is displayed.

For Your Safety

To prevent damage to property or injury to yourself or to others, read "For Your Safety" in its entirety before using this product.

Keep these safety instructions where all those who use this product will read them.

⚠ DANGER: Failure to observe the precautions marked with this icon carries a high risk of death or severe injury.

⚠ WARNING: Failure to observe the precautions marked with this icon could result in death or severe injury.

⚠ CAUTION: Failure to observe the precautions marked with this icon could result in injury or property damage.



WARNING

- **Do not use while walking or operating a vehicle.**

Failure to observe this precaution could result in accidents or other injury.

- **Do not disassemble or modify this product. Do not touch internal parts that become exposed as the result of a fall or other accident.**

Failure to observe these precautions could result in electric shock or other injury.

- **Should you notice any abnormalities such as the product producing smoke, heat, or unusual odors, immediately disconnect the battery or power source.**

Continued operation could result in fire, burns or other injury.

- **Keep dry. Do not handle with wet hands. Do not handle the plug with wet hands.**

Failure to observe these precautions could result in fire or electric shock.

- **Do not let your skin remain in prolonged contact with this product while it is on or plugged in.**

Failure to observe this precaution could result in low-temperature burns.

- **Do not use this product in the presence of flammable dust or gas such as propane, gasoline or aerosols.**

Failure to observe this precaution could result in explosion or fire.

- **Do not directly view the sun or other bright light source through the lens.**

Failure to observe this precaution could result in visual impairment.

- **Do not aim the flash or AF-assist illuminator at the operator of a motor vehicle.**

Failure to observe this precaution could result in accidents.

- **Keep this product out of reach of children.**

Failure to observe this precaution could result in injury or product malfunction. In addition, note that small parts constitute a choking hazard. Should a child swallow any part of this product, seek immediate medical attention.

- **Do not entangle, wrap or twist the straps around your neck.**

Failure to observe this precaution could result in accidents.

- **Do not use batteries, chargers, AC adapters, or USB cables not specifically designated for use with this product. When using batteries, chargers, AC adapters, and USB cables designated for use with this product, do not:**

- **Damage, modify, forcibly tug or bend the cords or cables, place them under heavy objects, or expose them to heat or flame.**
- **Use travel converters or adapters designed to convert from one voltage to another or with DC-to-AC inverters.**

Failure to observe these precautions could result in fire or electric shock.

- **Do not handle the plug when charging the product or using the AC adapter during thunderstorms.**

Failure to observe this precaution could result in electric shock.

- **Do not handle with bare hands in locations exposed to extremely high or low temperatures.**

Failure to observe this precaution could result in burns, or frostbite.



CAUTION

- **Do not leave the lens pointed at the sun or other strong light sources.**

Light focused by the lens could cause fire or damage to product's internal parts. When shooting backlit subjects, keep the sun well out of the frame. Sunlight focused into the camera when the sun is close to the frame could cause fire.

- **Turn this product off when its use is prohibited. Disable wireless features when the use of wireless equipment is prohibited.**

The radio-frequency emissions produced by this product could interfere with equipment onboard aircraft or in hospitals or other medical facilities.

- **Remove the battery and disconnect the AC adapter if this product will not be used for an extended period.**

Failure to observe this precaution could result in fire or product malfunction.

- **Do not fire the flash in contact with or in close proximity to the skin or objects.**

Failure to observe this precaution could result in burns or fire.

- **Do not leave the product where it will be exposed to extremely high temperatures, for an extended period such as in an enclosed automobile or in direct sunlight.**

Failure to observe this precaution could result in fire or product malfunction.

- **Do not look directly at the AF-assist illuminator.**

Failure to observe this precaution could have adverse effects on vision.

- **Do not transport cameras or lenses with tripods or similar accessories attached.**

Failure to observe this precaution could result in injury or product malfunction.



DANGER (Batteries)

- **Do not mishandle batteries.**

Failure to observe the following precautions could result in the batteries leaking, overheating, rupturing, or catching fire:

- Use only rechargeable batteries approved for use in this product.
 - Do not expose batteries to flame or excessive heat.
 - Do not disassemble.
 - Do not short-circuit the terminals by touching them to necklaces, hairpins, or other metal objects.
 - Do not expose batteries or the products in which they are inserted to powerful physical shocks.
 - Do not step on batteries, pierce them with nails, or strike them with hammers.
-

- **Charge only as indicated.**

Failure to observe this precaution could result in the batteries leaking, overheating, rupturing, or catching fire.

- **If battery liquid comes into contact with the eyes, rinse with plenty of clean water and seek immediate medical attention.**

Delaying action could result in eye injuries.



WARNING (Batteries)

- **Keep batteries out of reach of children.**

Should a child swallow a battery, seek immediate medical attention.

- **Keep batteries out of reach of household pets and other animals.**

The batteries could leak, overheat, rupture, or catch fire if bitten, chewed, or otherwise damaged by animals.

- **Do not immerse batteries in water or expose to rain.**

Failure to observe this precaution could result in fire or product malfunction. Immediately dry the product with a towel or similar object should it become wet.

- **Discontinue use immediately should you notice any changes in the batteries, such as discoloration or deformation. Cease charging EN-EL25 rechargeable batteries if they do not charge in the specified period of time.**

Failure to observe these precautions could result in the batteries leaking, overheating, rupturing, or catching fire.

- **When batteries are no longer needed, insulate the terminals with tape.**

Overheating, rupture, or fire may result should metal objects come into contact with the terminals.

- **If battery liquid comes into contact with a person's skin or clothing, immediately rinse the affected area with plenty of clean water.**

Failure to observe this precaution could result in skin irritation.

Notices

- No part of the manuals included with this product may be reproduced, transmitted, transcribed, stored in a retrieval system, or translated into any language in any form, by any means, without Nikon's prior written permission.
- Nikon reserves the right to change the appearance and specifications of the hardware and software described in these manuals at any time and without prior notice.
- Nikon will not be held liable for any damages resulting from the use of this product.
- While every effort has been made to ensure that the information in these manuals is accurate and complete, we would appreciate it were you to bring any errors or omissions to the attention of the Nikon representative in your area (address provided separately).

Notice Concerning Prohibition of Copying or Reproduction

Note that simply being in possession of material that has been digitally copied or reproduced by means of a scanner, digital camera, or other device may be punishable by law.

• Items prohibited by law from being copied or reproduced

Do not copy or reproduce paper money, coins, securities, government bonds, or local government bonds, even if such copies or reproductions are stamped "Sample."

The copying or reproduction of paper money, coins, or securities which are circulated in a foreign country is prohibited.

Unless the prior permission of the government has been obtained, the copying or reproduction of unused postage stamps or post cards issued by the government is prohibited.

The copying or reproduction of stamps issued by the government and of certified documents stipulated by law is prohibited.

• Cautions on certain copies and reproductions

The government has issued cautions on copies or reproductions of securities issued by private companies (shares, bills, checks, gift certificates, etc.), commuter passes, or coupon tickets, except when a minimum of necessary copies are to be provided for business use by a company. Also, do not copy or reproduce passports issued by the government, licenses issued by public agencies and private groups, ID cards, and tickets, such as passes and meal coupons.

• Comply with copyright notices

Under copyright law, photographs or recordings of copyrighted works made with the camera cannot be used without the permission of the copyright holder. Exceptions apply to personal use, but note that even personal use may be restricted in the case of photographs or recordings of exhibits or live performances.

Use Only Nikon Brand Electronic Accessories

Nikon cameras are designed to the highest standards and include complex electronic circuitry. Only Nikon brand electronic accessories (including lenses, chargers, batteries, charging AC adapters, and flash accessories) certified by Nikon specifically for use with this Nikon digital camera are engineered and proven to operate within the operational and safety requirements of this electronic circuitry.

The use of non-Nikon electronic accessories could damage the camera and may void your Nikon warranty. The use of third-party rechargeable Li-ion batteries not bearing the Nikon holographic seal shown at right could interfere with normal operation of the camera or result in the batteries overheating, igniting, rupturing, or leaking.

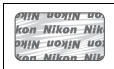

For more information about Nikon brand accessories, contact a local authorized Nikon dealer.

✔ Before Taking Important Pictures

Before taking pictures on important occasions (such as at weddings or before taking the camera on a trip), take a test shot to ensure that the camera is functioning normally. Nikon will not be held liable for damages or lost profits that may result from product malfunction.

✔ Life-Long Learning

As part of Nikon's "Life-Long Learning" commitment to ongoing product support and education, continually-updated information is available on-line at the following sites:

- **For users in the U.S.A.:** <https://www.nikonusa.com/>
 - **For users in Europe and Africa:** <https://www.europe-nikon.com/support/>
 - **For users in Asia, Oceania, and the Middle East:** <https://www.nikon-asia.com/>
- Visit these sites to keep up-to-date with the latest product information, tips, answers to frequently-asked questions (FAQs), and general advice on digital imaging and photography. Additional information may be available from the Nikon representative in your area. See the following URL for contact information: <https://imaging.nikon.com/>

Getting to Know the Camera

Take a few minutes to familiarize yourself with the names and functions of camera controls and displays. You may find it helpful to bookmark this section and refer to it as you read through the rest of the manual.

Parts of the Camera

Refer to this section for the names and locations of camera controls and displays.

Camera Body

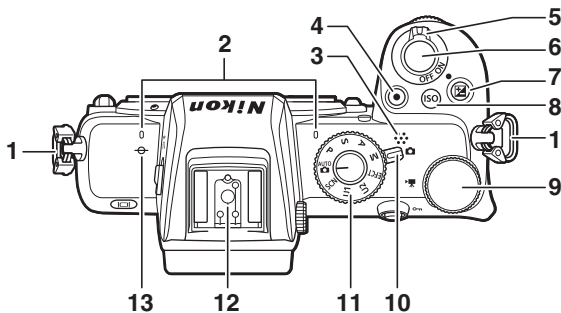

1	Eyelet for camera strap.....	9	ISO button
2	Stereo microphone.....	23	9 Main command dial
3	Speaker.....	25	10 Photo/movie selector 18, 22
4	Movie-record button	22	11 Mode dial
5	Power switch.....	17, 18	12 Accessory shoe (for optional flash unit)
6	Shutter-release button	18	13 Focal plane mark (⊖)
7	☒ button		

The Camera Body (Continued)

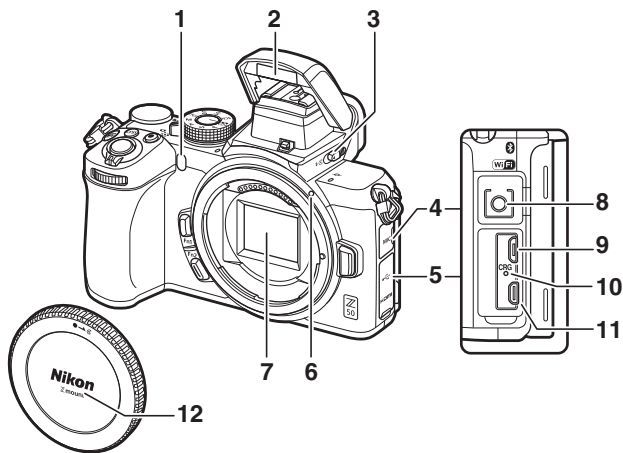

- | | |
|--|--|
| 1 AF-assist illuminator20 | 6 Lens mounting mark 15 |
| Red-eye reduction lamp | 7 Image sensor |
| Self-timer lamp | 8 Connector for external microphone |
| 2 Built-in flash | 9 USB connector |
| 3 Flash pop-up control | 10 Charge lamp |
| 4 Cover for microphone connector | 11 HDMI connector |
| 5 Cover for USB and HDMI connectors | 12 Body cap..... 15 |

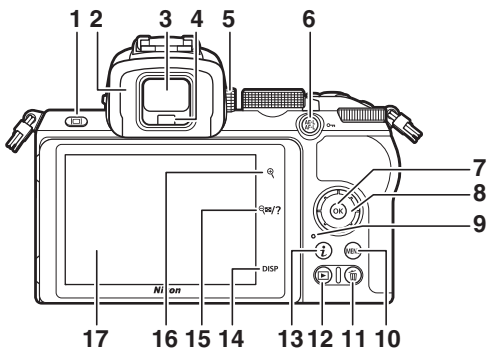

1 Monitor mode button	10 MENU button.....vi, 7
2 Viewfinder eyepiece	11 button 26
3 Viewfinder	12 button 24
4 Eye sensor	13 i button
5 Diopter adjustment control	14 DISP button
6 button	15 button..... 25
7 button8	16 button 25
8 Multi selector8	17 Monitor
9 Memory card access lamp 21	

The Camera Body (Continued)

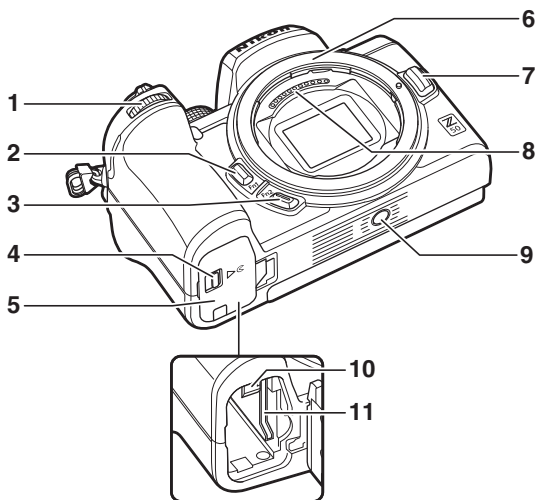

1 Sub-command dial	7 Lens release button 16
2 Fn1 button	8 CPU contacts
3 Fn2 button	9 Tripod socket
4 Battery-chamber cover latch 11	10 Battery latch 11
5 Battery-chamber cover 11	11 Memory card slot 11
6 Lens mount 15	

The Monitor and Viewfinder

At default settings, the following indicators appear in the monitor and viewfinder in photo mode.

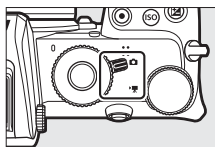

Monitor



Viewfinder

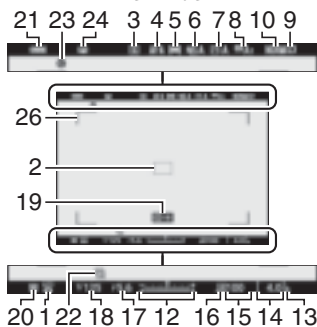

- 1** Shooting mode
- 2** Focus point..... 20
- 3** Release mode
- 4** Focus mode
- 5** AF-area mode
- 6** Active D-Lighting
- 7** Picture Control
- 8** White balance
- 9** Image size
- 10** Image quality
- 11**  icon

- 12** Exposure indicator
- Exposure compensation display
- 13** "k" (appears when memory remains for over 1000 exposures) 13
- 14** Number of exposures remaining 13
- 15** ISO sensitivity
- 16** ISO sensitivity indicator
- Auto ISO sensitivity indicator

17 Aperture	22 Shutter type
18 Shutter speed	23 “Clock not set” indicator
19 Subject tracking	24 Optical VR indicator
20 Metering	25 Touch shooting
21 Battery indicator13	26 AF-area brackets

The following items appear in movie mode.

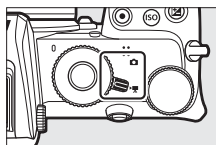

Monitor

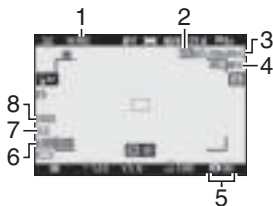

Viewfinder

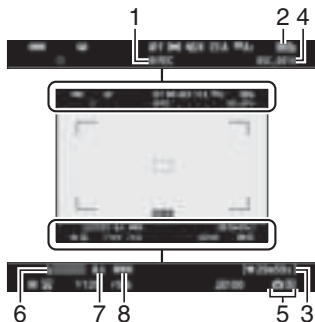

1 Recording indicator22 Recording disabled23	5 Release mode (still photography)
2 Frame size and rate/ image quality	6 Sound level
3 Time remaining22	7 Microphone sensitivity
4 File name	8 Frequency response

The MENU Button

Press the MENU button to view the menus.

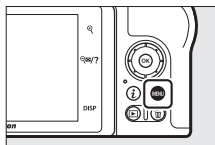

- 1 : Playback menu vi
- 2 : Photo shooting menu vi
- 3 : Movie shooting menu vii
- 4 : Custom Settings menu vii
- 5 : Setup menu ix
- 6 : Retouch menu ix
- 7 : My Menu or recent settings (defaults to My Menu) ix
- 8 : Help icon
- 9 : Current settings

■ Using the Menus

You can navigate the menus using the multi selector and **OK** button.

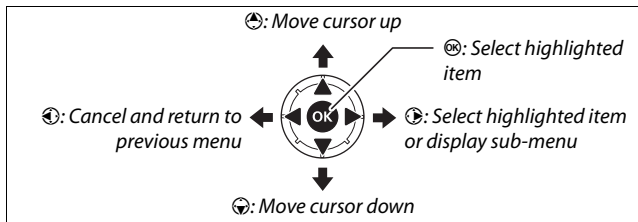

1 Highlight the icon for the current menu.

Press **⬅** to highlight the icon for the current menu.



2 Select a menu.

Press **⬆** or **⬇** to select the desired menu.

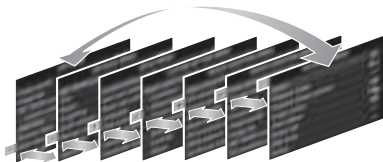

3 Position the cursor in the selected menu.

Press **➡** to position the cursor in the selected menu.



First Steps

Complete the steps in this chapter before taking pictures for the first time.

Attach the Camera Strap

A strap is supplied with the camera; additional straps are available separately. Attach the strap securely to the camera eyelets.

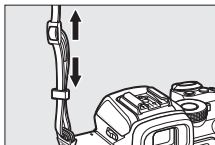
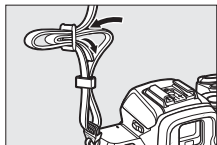
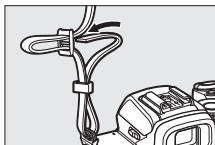
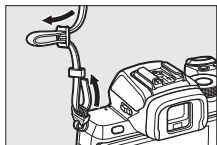

Charge the Battery

The battery can be charged using the supplied battery charger.

✔ The Battery and Charger

Read and follow the warnings and cautions in "For Your Safety" (☐ x) and "Caring for the Camera and Battery: Cautions" (☐ 27).

The Battery Charger

Insert the battery and plug the charger in. An exhausted battery will fully charge in about 2 hours and 30 minutes.

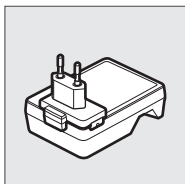

In some countries or regions, charger may be supplied with adapter connected.

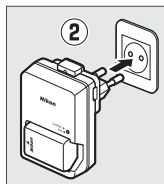
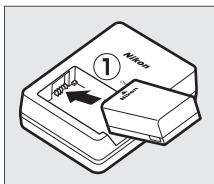

The **CHARGE** lamp will flash while the battery charges.

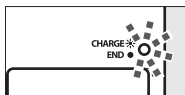

*Battery charging
(flashing)*

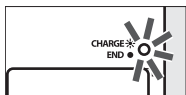

*Charging complete
(steady)*

Insert the Battery and a Memory Card

Before inserting or removing the battery or memory cards, confirm that the camera power switch is in the **OFF** position. Insert the battery in the orientation shown, using the battery to keep the orange battery latch pressed to one side. The latch locks the battery in place when the battery is fully inserted. Holding the memory card in the orientation shown, slide it straight into the slot until it clicks into place.

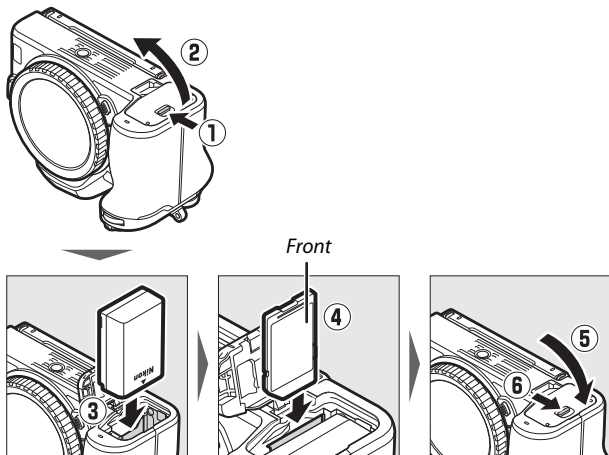

✔ Removing the Battery

To remove the battery, turn the camera off and open the battery-chamber cover. Press the battery latch in the direction shown by the arrow to release the battery and then remove the battery by hand.

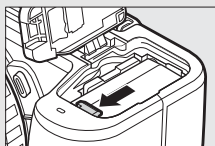

✔ Removing Memory Cards



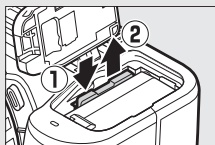

After confirming that the memory card access lamp is off, turn the camera off, open the battery-chamber cover, and press the card in to eject it (①). The card can then be removed by hand (②).

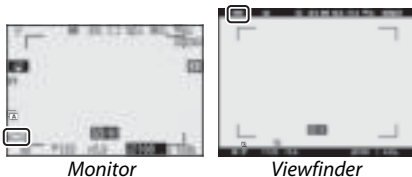

Battery Level

The battery level is shown in the shooting display while the camera is on.



The battery level display changes as the battery level diminishes, from  through  and finally to . When the battery level falls to , suspend shooting and charge the battery or ready a spare battery. When the battery is exhausted, the  icon will flash; charge the battery or insert a fully-charged spare battery.

Number of Exposures Remaining

When the camera is on, the shooting display show the number of photographs that can be taken at current settings (values over 1000 are rounded down to the nearest hundred; e.g., values between 1400 and 1499 are shown as 1.4 k).

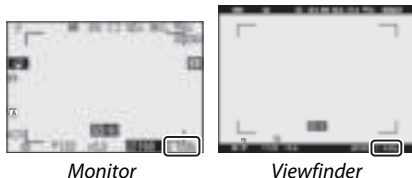

✔ Memory Cards

- Memory cards may be hot after use. Observe due caution when removing memory cards from the camera.
- Turn the power off before inserting or removing memory cards. Do not remove memory cards from the camera, turn the camera off, or remove the battery during formatting or while data are being recorded, deleted, or copied to a computer or other device. Failure to observe these precautions could result in loss of data or in damage to the camera or card.
- Do not touch the card terminals with your fingers or metal objects.
- Do not apply force to the card casing. Failure to observe this precaution could damage the card.
- Do not bend, drop, or subject to strong physical shocks.
- Do not expose to water, heat, high levels of humidity, or direct sunlight.
- Do not format memory cards in a computer.

✔ No Memory Card

If no memory card is inserted, a “no memory card” indicator and [-E-] will appear in the shooting display.

✔ The Write Protect Switch

SD memory cards are equipped with a write protect switch to prevent accidental loss of data. When this switch is in the “lock” position, the memory card cannot be formatted and photos cannot be deleted or recorded (a warning will be displayed in the monitor if you attempt to release the shutter). To unlock the memory card, slide the switch to the “write” position.

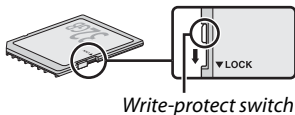

Attach a Lens

The camera can be used with Z mount lenses. Before attaching or removing lenses, confirm that the camera power switch is in the **OFF** position. Be careful to prevent dust from entering the camera when the lens or body cap is removed, and be sure to remove the lens cap before taking pictures. The lens generally used in this manual for illustrative purposes is a NIKKOR Z DX 16–50mm f/3.5–6.3 VR.

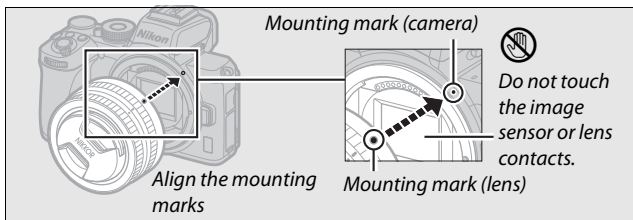
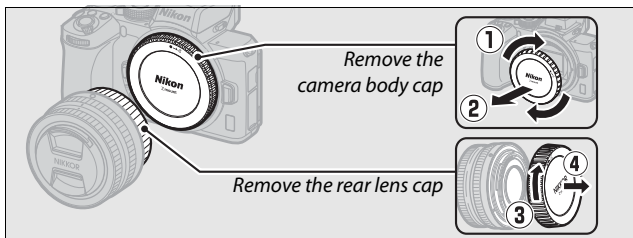

✓ F Mount Lenses

Be sure to attach the FTZ mount adapter (available separately) before using F mount lenses. Attempting to attach F mount lenses directly to the camera could damage the lens or image sensor.

✓ Detaching Lenses

Be sure the camera is off when removing or exchanging lenses. To remove the lens, press and hold the lens release button (1) while turning the lens clockwise (2). After removing the lens, replace the lens caps and camera body cap.

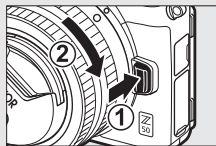

Turn the Camera On

When you first turn the camera on, you will be prompted to choose a language using the multi selector and **OK** button.

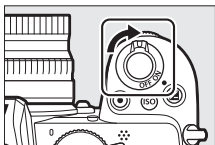

Press **MENU** and use the multi selector and **OK** button to set the camera clock. No other operations can be performed until the clock is set.

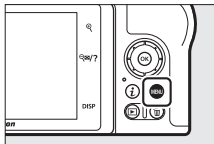

Select time zone



Select date format



Select daylight saving time option



Set time and date (note that camera uses a 24-hour clock)

Basic Photography and Playback

This chapter explains the basics of taking and viewing photos.

Taking Photographs (AUTO Mode)

Follow the steps below to take photographs in ^{AUTO} (auto) mode, an automatic “point-and-shoot” mode in which the majority of settings are controlled by the camera in response to shooting conditions.

- 1 Turn the camera on.**
The monitor will light.

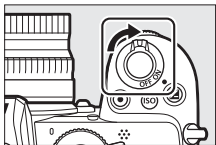

- 2 Select photo mode.**
Rotate the photo/movie selector to .

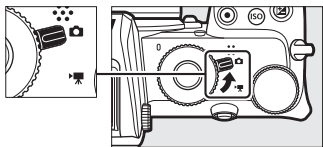

Lenses with Retractable Barrels

Lenses with retractable barrels must be extended before use. Rotate the lens zoom as shown until the lens clicks into the extended position.

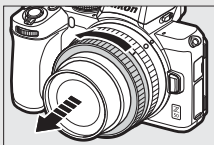

3 Select ^{AUTO} mode.

Rotate the mode dial to ^{AUTO}.

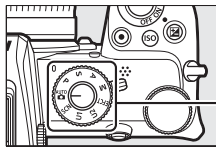

Mode dial

4 Ready the camera.

Hold the handgrip in your right hand and cradle the camera body or lens with your left. Bring your elbows in against the sides of your chest.

Framing photos in the viewfinder



Landscape (wide) orientation



Portrait (tall) orientation

Framing photos in the monitor



Landscape (wide) orientation



Portrait (tall) orientation

5 Frame the photograph.

Frame the shot with your subject in the AF-area brackets.



AF-area brackets

6 Press the shutter-release button halfway to focus.

- If the subject is stationary, the focus point will be displayed in green when the camera focuses. If the camera is unable to focus, the AF-area brackets will flash. If the subject is in motion, the camera will continue to adjust focus in response to changes in the distance to the subject while the shutter-release button is pressed halfway; focus will not lock.
- The AF-assist illuminator may light to assist the focus operation if the subject is poorly lit.



Focus point

The AF-Assist Illuminator

Do not obstruct the AF-assist illuminator while it is lit.

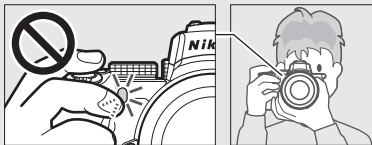

7 Shoot.

Smoothly press the shutter-release button the rest of the way down to take the photograph (you can also take a photograph by touching the monitor: touch your subject to focus and lift your finger to release the shutter). The memory card access lamp will light while the photo is recorded to the memory card. *Do not eject the memory card or remove the battery until the lamp has gone out and recording is complete.*

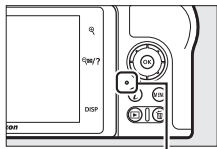

Memory card access lamp

The Standby Timer

If no operations are performed for about 30 seconds, the display will dim before the monitor and viewfinder turn off to reduce the drain on the battery. Press the shutter-release button halfway to reactivate the display. The length of time before the standby timer expires automatically can be selected using Custom Setting c3 (**Power off delay**) > **Standby timer**.



Shooting Movies (AUTO Mode)

^{AUTO} (auto) mode can also be used for simple, “point-and-shoot” movie recording.

- 1 Turn the camera on.**
The monitor will light.

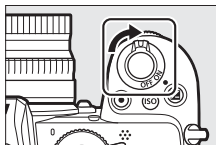

- 2 Select movie mode.**
Rotate the photo/movie selector to . Note that the built-in flash and optional flash units cannot be used when the camera is in movie mode.

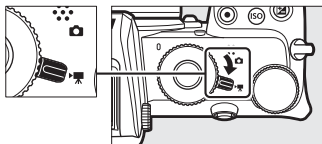

- 3 Select ^{AUTO} mode.**
Rotate the mode dial to ^{AUTO} .

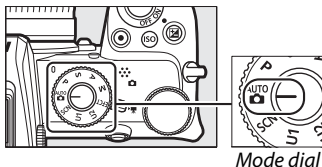

4 Start recording.

Press the movie-record button to start recording. While recording is in progress, the camera will display a recording indicator and the time remaining. The camera can be refocused at any time during recording by tapping your subject in the display. Sound is recorded via the built-in microphone; do not cover the microphone during recording.

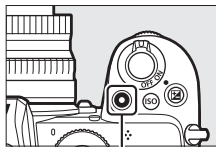

Movie-record button

Recording indicator



Time remaining

5 End recording.

Press the movie-record button again to end recording. The memory card access lamp will light while the camera finishes saving the movie to the memory card. *Do not eject the memory card or remove the battery until the lamp has gone out and recording is complete.*

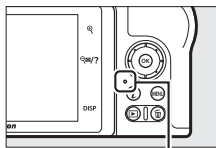
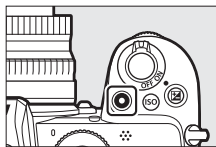

Memory card
access lamp

✓ The Icon



A  icon indicates that movies cannot be recorded.

Basic Playback

Photographs and movies can be viewed on the camera.

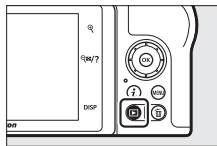

- 1 Press the  button.
A picture will appear in the display.



- 2 View additional pictures.
Press  or  to view additional pictures. When pictures are displayed in the monitor, you can view other pictures by flicking a finger left or right over the display. To end playback and return to shooting mode, press the shutter-release button halfway.







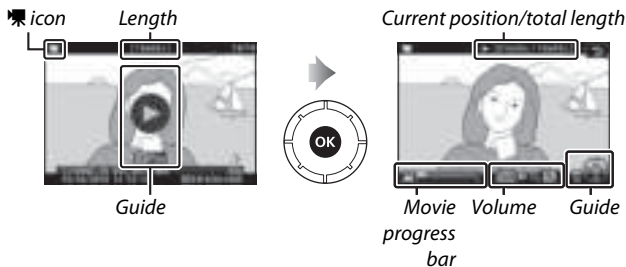







Viewing Movies

Movies are indicated by a  icon. Tap the on-screen guide or press  to start playback; your current position is shown on the movie progress bar.



The following operations can be performed:

Operation	Description
Pause	Press  to pause playback.
Play	Press  to resume playback when playback is paused or during rewind/advance.
Rewind/advance	Press  to rewind,  to advance. Speed increases with each press, from 2x to 4x to 8x to 16x; keep the control pressed to skip to the beginning or end of the movie (the first frame is indicated by a  in the top right corner of the display, the last frame by a ). If playback is paused, the movie rewinds or advances one frame at a time; keep the control pressed for continuous rewind or advance.
Start slow-motion playback	Press  while the movie is paused to start slow-motion playback.
Skip 10 s	Rotate the main command dial one stop to skip ahead or back 10 s.
Skip to last or first frame	Rotate the sub-command dial to skip to the last or first frame.
Adjust volume	Tap  to increase volume,  to decrease.
Trim movie	To view movie editing options, pause playback and press the  button.
Exit	Press  or  to exit to full-frame playback.
Return to shooting mode	Press the shutter-release button halfway to end playback.

Deleting Unwanted Pictures



Press the  button to delete the current picture. *Note that pictures cannot be recovered once deleted.*

1 Display a picture you wish to delete.

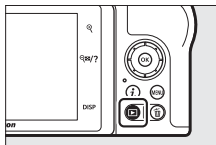
Display a photo or movie you wish to delete as described in “Basic Playback” (📖 24).



2 Delete the picture.

Press the  button. A confirmation dialog will be displayed; press the  button again to delete the picture and return to playback. To exit without deleting the picture, press .

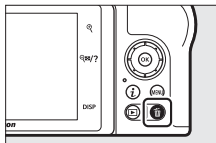

Delete

To delete selected pictures, all pictures taken on selected dates, or all pictures in a chosen location on the memory card, use the **Delete** option in the playback menu.

Technical Notes

Caring for the Camera and Battery: Cautions

Do not drop: The product may malfunction if subjected to strong shocks or vibration.

Keep dry: This product is not waterproof, and may malfunction if immersed in water or exposed to high levels of humidity. Rusting of the internal mechanism can cause irreparable damage.

Avoid sudden changes in temperature: Sudden changes in temperature, such as those that occur when entering or leaving a heated building on a cold day, can cause condensation inside the device. To prevent condensation, place the device in a carrying case or plastic bag before exposing it to sudden changes in temperature.

Keep away from strong magnetic fields: Do not use or store this device in the vicinity of equipment that generates strong electromagnetic radiation or magnetic fields. Static charges or the magnetic fields produced by equipment such as radio transmitters could interfere with the display, damage data stored on the memory card, or affect the product's internal circuitry.

Do not leave the lens pointed at the sun: Do not leave the lens pointed at the sun or other strong light source for an extended period. Intense light may cause the image sensor to deteriorate or produce a white blur effect in photographs.

Lasers and other bright light sources: Do not direct lasers or other extremely bright light sources toward the lens, as this could damage the camera's image sensor.

Turn the product off before removing the battery: Do not remove the battery while the product is on or while images are being recorded or deleted. Forcibly cutting power in these circumstances could result in loss of data or in damage to product memory or internal circuitry.

Cleaning: When cleaning the camera body, use a blower to gently remove dust and lint, then wipe gently with a soft, dry cloth. After using the camera at the beach or seaside, wipe off any sand or salt using a cloth lightly dampened in pure water and then dry the camera thoroughly.

Lenses, viewfinders, and other glass elements are easily damaged. Dust and lint should be gently removed with a blower. When using an aerosol blower, keep the can vertical to prevent discharge of liquid. To remove fingerprints and other stains from glass surfaces, apply a small amount of lens cleaner to a soft cloth and wipe the glass carefully.

Do not touch the image sensor: Under no circumstances should you exert pressure on the image sensor, poke it with cleaning tools, or subject it to powerful air currents from a blower. These actions could scratch or otherwise damage the sensor.

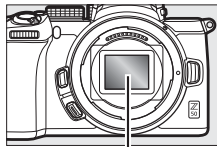

Image sensor

Lens contacts: Keep the lens contacts clean and be careful not to touch them with your fingers or with tools or other objects.

Storage: To prevent mold or mildew, store the camera in a dry, well-ventilated area. If the product will not be used for an extended period, remove the battery to prevent leakage and store the camera in a plastic bag containing a desiccant. Do not, however, store the camera case in a plastic bag, as this may cause the material to deteriorate. Note that desiccant gradually loses its capacity to absorb moisture and should be replaced at regular intervals.

To prevent mold or mildew, take the camera out of storage at least once a month. Turn the camera on and release the shutter a few times before putting it away.

Store the battery in a cool, dry place. Replace the terminal cover before putting the battery away.

Notes on the monitor and viewfinder: These displays are constructed with extremely high precision; at least 99.99% of pixels are effective, with no more than 0.01% being missing or defective. Hence while these displays may contain pixels that are always lit (white, red, blue, or green) or always off (black), this is not a malfunction and has no effect on images recorded with the device.

Images in the monitor may be difficult to see in a bright light. Do not apply pressure to the monitor, as this could cause damage or malfunction. Dust or lint can be removed with a blower. Stains can be removed by wiping lightly with a soft cloth or chamois leather. Should the monitor break, care should be taken to avoid injury from broken glass and to prevent liquid crystal from the monitor touching the skin or entering the eyes and mouth.

Should you feel unwell or experience any of the following symptoms while framing shots in the viewfinder, discontinue use until your condition improves: nausea, eye pain, eye fatigue, dizziness, headache, stiffness in your neck or shoulders, carsickness, or loss of hand-eye coordination. The same applies should you start to feel unwell when watching the shooting display flicker rapidly on and off during burst photography.

Noise in the form of lines may in rare cases appear in pictures that include bright lights or back-lit subjects.

The battery and charger: Batteries may leak or explode if improperly handled. Observe the following precautions when handling batteries and chargers:

- Use only batteries approved for use in this equipment.
- Do not expose the battery to flame or excessive heat.
- Keep the battery terminals clean.
- Turn the product off before replacing the battery.
- The battery may become hot while in use. Observe caution when handling the battery immediately after use.

- Remove the battery from the camera or charger when not in use and replace the terminal cover. These devices draw minute amounts of charge even when off and could draw the battery down to the point that it will no longer function. If the battery will not be used for some time, insert it in the camera and run it flat before removing it from the camera for storage. The battery should be stored in a cool location with an ambient temperature of 15 °C to 25 °C (59 °F to 77 °F; avoid hot or extremely cold locations). Repeat this process at least once every six months.
- Turning the camera on or off repeatedly when the battery is fully discharged will shorten battery life. Batteries that have been fully discharged must be charged before use.
- The internal temperature of the battery may rise while the battery is in use. Attempting to charge the battery while the internal temperature is elevated will impair battery performance, and the battery may not charge or charge only partially. Wait for the battery to cool before charging.
- Charge the battery indoors at ambient temperatures of 5 °C to 35 °C (41 °F to 95 °F). Do not use the battery at ambient temperatures below 0 °C (32 °F) or above 40 °C (104 °F); failure to observe this precaution could damage the battery or impair its performance. Capacity may be reduced and charging times increase at battery temperatures from 0 °C (32 °F) to 15 °C (59 °F) and from 45 °C (113 °F) to 60 °C (140 °F). The battery will not charge if its temperature is below 0 °C (32 °F) or above 60 °C (140 °F).
- If the charge lamp flashes quickly (about eight times a second) during charging, confirm that the temperature is in the correct range and then unplug the charger and remove and reinsert the battery. If the problem persists, cease use immediately and take battery and charger to your retailer or a Nikon-authorized service representative.
- Do not move the charger or touch the battery during charging. Failure to observe this precaution could in very rare instances result in the charger showing that charging is complete when the battery is only partially charged. Remove and reinsert the battery to begin charging again.

- Battery capacity may temporarily drop if the battery is charged at low temperatures or used at a temperature below the temperature at which it was charged.
- Continuing to charge the battery after it is fully charged can impair battery performance.
- A marked drop in the time a fully charged battery retains its charge when used at room temperature indicates that it requires replacement. Purchase a new battery.
- Use the charger with compatible batteries only. Unplug when not in use.
- Do not short the charger terminals. Failure to observe this precaution could result in overheating and damage to the charger.
- Charge the battery before use. When taking photographs on important occasions, ready a spare battery and keep it fully charged. Depending on your location, it may be difficult to purchase replacement batteries on short notice. Note that on cold days, the capacity of batteries tends to decrease. Be sure the battery is fully charged before taking photographs outside in cold weather. Keep a spare battery in a warm place and exchange the two as necessary. Once warmed, a cold battery may recover some of its charge.
- Recycle rechargeable batteries in accord with local regulations, being sure to first insulate the terminals with tape.
- Do not use chargers with damage that leaves the interior exposed or that produce unusual sounds when used.

The charging AC adapter: Observe the precautions below when using the charging AC adapter.

- Do not move the camera during charging. Failure to observe this precaution could in very rare instances result in the camera showing that charging is complete when the battery is only partially charged. Disconnect and reconnect the adapter to begin charging again.
- Do not short the adapter terminals. Failure to observe this precaution could result in overheating and damage to the adapter.
- Unplug the adapter when it is not in use.
- Do not use adapters with damage that leaves the interior exposed or that produce unusual sounds when used.

Specifications

Nikon Z 50 Digital Camera

Type	
Type	Digital camera with support for interchangeable lenses
Lens mount	Nikon Z mount
Lens	
Compatible lenses	<ul style="list-style-type: none">• Z mount NIKKOR lenses• F mount NIKKOR lenses with mount adapter; restrictions may apply
Effective pixels	
Effective pixels	20.9 million
Image sensor	
Image sensor	23.5 × 15.7 mm CMOS sensor (Nikon DX format)
Total pixels	21.51 million
Dust-Reduction System	Image Dust Off reference data (requires Capture NX-D)
Storage	
Image size (pixels)	<ul style="list-style-type: none">• DX (24×16) image area 5568 × 3712 (Large: 20.7 M) 4176 × 2784 (Medium: 11.6 M) 2784 × 1856 (Small: 5.2 M)• 1 : 1 (16×16) image area 3712 × 3712 (Large: 13.8 M) 2784 × 2784 (Medium: 7.8 M) 1856 × 1856 (Small: 3.4 M)• 16 : 9 (24×14) image area 5568 × 3128 (Large: 17.4 M) 4176 × 2344 (Medium: 9.8 M) 2784 × 1560 (Small: 4.3 M)• Photographs taken during movie recording at a frame size of 3840 × 2160: 3840 × 2160• Photographs taken during movie recording at a frame size of 1920 × 1080: 1920 × 1080

Storage	
File format	<ul style="list-style-type: none"> • NEF (RAW): 12 or 14 bit • JPEG: JPEG-Baseline compliant with fine (approx. 1 : 4), normal (approx. 1 : 8), or basic (approx. 1 : 16) compression • NEF (RAW)+JPEG: Single photograph recorded in both NEF (RAW) and JPEG formats
Picture Control System	Auto, Standard, Neutral, Vivid, Monochrome, Portrait, Landscape, Flat, Creative Picture Controls (Dream, Morning, Pop, Sunday, Somber, Dramatic, Silence, Bleached, Melancholic, Pure, Denim, Toy, Sepia, Blue, Red, Pink, Charcoal, Graphite, Binary, Carbon); selected Picture Control can be modified; storage for custom Picture Controls
Media	SD (Secure Digital) and UHS-I compliant SDHC and SDXC memory cards
File system	DCF 2.0, Exif 2.31, PictBridge
Viewfinder	
Viewfinder	0.99-cm/0.39-in. approx. 2360k-dot (XGA) OLED electronic viewfinder with color balance and auto and 7-level manual brightness controls
Frame coverage	Approx. 100% horizontal and 100% vertical
Magnification	Approx. 1.02× (50 mm lens at infinity, -1.0 m^{-1})
Eyepoint	19.5 mm (-1.0 m^{-1} ; from center surface of viewfinder eyepiece lens)
Diopter adjustment	$-3 - +3 \text{ m}^{-1}$
Eye sensor	Automatically switches between monitor and viewfinder displays
Monitor	
Monitor	8-cm/3.2-in., approx. 1040k-dot tilting TFT touch-sensitive LCD with 170° viewing angle, approximately 100% frame coverage, and 11-level manual brightness controls

Shutter	
Type	Electronically-controlled vertical-travel focal-plane mechanical shutter; electronic front-curtain shutter; electronic shutter
Speed	$\frac{1}{4000}$ – 30 s (choose from step sizes of $\frac{1}{3}$ and $\frac{1}{2}$ EV), bulb, time
Flash sync speed	$X = \frac{1}{200}$ s; synchronizes with shutter at $\frac{1}{200}$ s or slower; Auto FP High-Speed sync supported
Release	
Release mode	Single frame, low-speed continuous, high-speed continuous, high-speed continuous (extended), self-timer
Approximate maximum frame advance rate (measured under Nikon-specified test conditions)	<ul style="list-style-type: none"> • Low-speed continuous: 1–4 fps • High-speed continuous: 5 fps • High-speed continuous (extended): 11 fps
Self-timer	2 s, 5 s, 10 s, 20 s; 1–9 exposures at intervals of 0.5, 1, 2, or 3 s
Exposure	
Metering system	TTL metering using camera image sensor
Metering mode	<ul style="list-style-type: none"> • Matrix metering • Center-weighted metering: Weight of 75% given to 8 mm circle in center of frame; weighting can instead be based on average of entire frame • Spot metering: Meters 3.5 mm circle (about 2.5% of frame) centered on selected focus point • Highlight-weighted metering
Range (ISO 100, f/2.0 lens, 20 °C/68 °F)	–4 – +17 EV

Exposure	
Mode	<ul style="list-style-type: none"> • AUTO: Auto, P: programmed auto with flexible program, S: shutter-priority auto, A: aperture-priority auto, M: manual • Scene modes: 🧑 portrait; 🌄 landscape; 👶 child; 🏀 sports; 🌸 close up; 🌃 night portrait; 🌃 night landscape; 🎉 party/indoor; 🏖️ beach/snow; 🌅 sunset; 🌄 dusk/dawn; 🐾 pet portrait; 🕯️ candlelight; 🌸 blossom; 🍂 autumn colors; 🍴 food • Special effect modes: 🌃 night vision; 🌈 VI super vivid; 🎨 POP pop; 🖼️ photo illustration; 📷 toy camera effect; 🏠 miniature effect; 🖌️ selective color; 🖋️ silhouette; 📈 high key; 📉 low key • U1 and U2: user settings
Exposure compensation	-5 – +5 EV (choose from step sizes of 1/3 and 1/2 EV) available in P, S, A, M, SCN, and EFCT modes
Exposure lock	Luminosity locked at detected value
ISO sensitivity (Recommended Exposure Index)	ISO 100 – 51200 (choose from step sizes of 1/3 and 1/2 EV); can also be set to approx. 1 or 2 EV (ISO 204800 equivalent) above ISO 51200; auto ISO sensitivity control available
Active D-Lighting	Can be selected from Auto, Extra high, High, Normal, Low, or Off
Multiple exposure	Add, average, lighten, darken
Other options	HDR (high dynamic range), photo mode flicker reduction
Focus	
Autofocus	Hybrid phase-detection/contrast AF with AF assist
Detection range (single-servo AF, photo mode, ISO 100, f/2.0 lens, 20 °C/68 °F)	-4 – +19 EV <ul style="list-style-type: none"> • Without low-light AF: -2 – +19 EV

Focus	
Lens servo	<ul style="list-style-type: none"> • Autofocus (AF): Single-servo AF (AF-S); continuous-servo AF (AF-C); AF mode auto-switch (AF-A; available only in photo mode); full-time AF (AF-F; available only in movie mode); predictive focus tracking • Manual focus (M): Electronic rangefinder can be used
Focus points (single-point AF, photo mode, DX image area)	209
AF-area mode	Pinpoint, single-point, and dynamic-area AF (pinpoint and dynamic-area AF available in photo mode only); wide-area AF (S); wide-area AF (L); auto-area AF
Focus lock	Focus can be locked by pressing shutter-release button halfway (single-servo AF) or by pressing <small>AE-L</small> <small>AF-L</small> (O-n) button
Flash	
Built-in flash	Manual pop-up flash raised via flash pop-up control Guide Number: Approx. 7/22, 7/22 with manual flash (m/ft, ISO 100, 20 °C/68 °F)
Charging time	Approx. 3 s
Flash control	TTL: i-TTL flash control; i-TTL balanced fill-flash is used with matrix, center-weighted, and highlight-weighted metering, standard i-TTL fill-flash with spot metering
Flash mode	Fill flash, red-eye reduction, slow sync, slow sync + red-eye, rear-curtain sync, auto, auto + red-eye reduction, auto slow sync, auto slow sync + red-eye, flash off
Flash compensation	-3 – +1 EV (choose from step sizes of 1/3 and 1/2 EV) available in P , S , A , M , and SCN modes

Flash	
Flash-ready indicator	Lights when built-in flash or optional flash unit is fully charged; flashes as underexposure warning after flash is fired at full output
Accessory shoe	ISO 518 hot-shoe with sync and data contacts and safety lock
Nikon Creative Lighting System (CLS)	i-TTL flash control, optical Advanced Wireless Lighting, FV lock, Color Information Communication, Auto FP High-Speed Sync
White balance	
White balance	Auto (3 types), natural light auto, direct sunlight, cloudy, shade, incandescent, fluorescent (7 types), flash, choose color temperature (2500 K–10,000 K), preset manual (up to 6 values can be stored), all except choose color temperature with fine-tuning
Bracketing	
Bracketing types	Exposure, white balance, and ADL
Movie	
Metering system	TTL metering using camera image sensor
Metering mode	Matrix, center-weighted, or highlight-weighted
Frame size (pixels) and frame rate	<ul style="list-style-type: none"> • 3840 × 2160 (4K UHD); 30p (progressive), 25p, 24p • 1920 × 1080; 120p, 100p, 60p, 50p, 30p, 25p, 24p • 1920 × 1080 (slow-motion); 30p × 4, 25p × 4, 24p × 5 <p>Actual frame rates for 120p, 100p, 60p, 50p, 30p, 25p, and 24p are 119.88, 100, 59.94, 50, 29.97, 25, and 23.976 fps respectively; quality selection available except at sizes of 3840 × 2160, 1920 × 1080 120p/100p, and 1920 × 1080 slow-motion, in which case quality is fixed at ★ (high)</p>

Movie	
File format	MOV, MP4
Video compression	H.264/MPEG-4 Advanced Video Coding
Audio recording format	Linear PCM, AAC
Audio recording device	Built-in stereo or external microphone with attenuator option; sensitivity adjustable
Exposure compensation	-3 – +3 EV (choose from step sizes of 1/3 and 1/2 EV) available in P, S, A, M, SCN , and EFCT modes
ISO sensitivity (Recommended Exposure Index)	<ul style="list-style-type: none"> • M: Manual selection (ISO 100 to 25600; choose from step sizes of 1/3 and 1/2 EV); auto ISO sensitivity control (ISO 100 to 25600) available with selectable upper limit • P, S, A: Auto ISO sensitivity control (ISO 100 to 25600) with selectable upper limit • AUTO, SCN, EFCT (excluding : Auto ISO sensitivity control (ISO 100 to Hi 4)
Active D-Lighting	Can be selected from Same as photo settings , Extra high , High , Normal , Low , or Off
Other options	Time-lapse movies, electronic vibration reduction
Playback	
Playback	Full-frame and thumbnail (4, 9, or 72 images) playback with playback zoom, playback zoom cropping, movie playback, photo and/or movie slide shows, histogram display, highlights, photo information, location data display, auto image rotation, and picture rating
Interface	
USB	Hi-Speed USB with Micro-B connector; connection to built-in USB port is recommended
HDMI output	Type D HDMI connector
Audio input	Stereo mini-pin jack (3.5 mm diameter; plug-in power supported)

Wi-Fi/Bluetooth

Wi-Fi	<ul style="list-style-type: none">• Standards:<ul style="list-style-type: none">- IEEE 802.11b/g/n (Africa, Asia, Oceania, and the following European countries: Albania, Armenia, Georgia, Kyrgyzstan, Moldova, and Tajikistan)- IEEE 802.11b/g/n/a/ac (other European countries, Uzbekistan, U.S.A., Canada, Mexico)- IEEE 802.11b/g/n/a (other countries in the Americas)• Operating frequency:<ul style="list-style-type: none">- 2412–2462 MHz (channel 11) (Africa, Asia, Oceania, and the following European countries: Albania, Armenia, Georgia, Kyrgyzstan, Moldova, and Tajikistan)- 2412–2462 MHz (channel 11) and 5180–5320 MHz (other European countries, Uzbekistan)- 2412–2462 MHz (channel 11) and 5180–5825 MHz (U.S.A., Canada, Mexico)- 2412–2462 MHz (channel 11) and 5180–5805 MHz (other countries in the Americas)• Maximum output power (EIRP):<ul style="list-style-type: none">2.4 GHz band: 6.9 dBm5 GHz band: 10.2 dBm• Authentication: Open system, WPA2-PSK
Bluetooth	<ul style="list-style-type: none">• Communication protocols: Bluetooth Specification Version 4.2• Operating frequency:<ul style="list-style-type: none">Bluetooth: 2402–2480 MHzBluetooth Low Energy: 2402–2480 MHz• Maximum output power (EIRP):<ul style="list-style-type: none">Bluetooth: 1.4 dBmBluetooth Low Energy: –0.1 dBm
Range (line of sight)	Approximately 10 m (32 ft) without interference; range may vary with signal strength and presence or absence of obstacles

Power source	
Battery	One EN-EL25 rechargeable Li-ion battery
Charging AC adapter	EH-73P charging AC adapter
Tripod socket	
Tripod socket	1/4 in. (ISO 1222)
Dimensions/weight	
Dimensions (W × H × D)	Approx. 126.5 × 93.5 × 60 mm (5 × 3.7 × 2.4 in.)
Weight	Approx. 450 g (15.9 oz.) with battery and memory card but without body cap; approx. 395 g/14 oz. (camera body only)
Operating environment	
Temperature	0 °C–40 °C (+32 °F–104 °F)
Humidity	85% or less (no condensation)

- Unless otherwise stated, all measurements are performed in conformity with Camera and Imaging Products Association (CIPA) standards or guidelines.
- All figures are for a camera with a fully-charged battery.
- The sample images displayed on the camera and the images and illustrations in the manuals are for expository purposes only.
- Nikon reserves the right to change the appearance and specifications of the hardware and software described in this manual at any time and without prior notice. Nikon will not be held liable for damages that may result from any mistakes that this manual may contain.

■ ■ MH-32 Battery Charger

Rated input	AC 100–240 V, 50/60 Hz, 0.21 A
Rated output	DC 8.4 V/1.12 A (MAX)
Supported batteries	Nikon EN-EL25 rechargeable Li-ion batteries
Charging time	Approx. 2 hours and 30 minutes at an ambient temperature of 25 °C (77 °F) when no charge remains
Operating temperature	0 °C–40 °C (+32 °F–104 °F)
Dimensions (W × H × D)	Approx. 67 × 94 × 28 mm (2.7 × 3.8 × 1.2 in.), excluding plug adapter
Weight	Approx. 99 g (3.5 oz), excluding plug adapter

The symbols on this product represent the following:

~ AC, --- DC,  Class II equipment (The construction of the product is double-insulated.)

■ ■ EN-EL25 Rechargeable Li-ion Battery

Type	Rechargeable lithium-ion battery
Rated capacity	7.6 V/1120 mAh
Operating temperature	0 °C–40 °C (+32 °F–104 °F)
Dimensions (W × H × D)	Approx. 34 × 50.5 × 18 mm (1.4 × 2.0 × 0.8 in.)
Weight	Approx. 53 g (1.9 oz), excluding terminal cover

Nikon reserves the right to change the appearance and specifications of the hardware and software described in this manual at any time and without prior notice. Nikon will not be held liable for damages that may result from any mistakes that this manual may contain.

✎ Disposing of Data Storage Devices

Please note that deleting images or formatting memory cards or other data storage devices does not completely erase the original image data. Deleted files can sometimes be recovered from discarded storage devices using commercially available software, potentially resulting in the malicious use of personal image data. Ensuring the privacy of such data is the user's responsibility.

Before discarding a data storage device or transferring ownership to another person, erase all data using commercial deletion software, or format the device and then completely refill it with images containing no private information (for example, pictures of empty sky). Care should be taken to avoid injury when physically destroying data storage devices.

Before discarding the camera or transferring ownership to another person, you should also use the **Reset all settings** option in the camera setup menu to delete network settings and other personal information.

✎ Supported Standards

- **DCF Version 2.0:** The Design Rule for Camera File System (DCF) is a standard widely used in the digital camera industry to ensure compatibility among different makes of camera.
- **Exif version 2.31:** The camera supports Exif (Exchangeable Image File Format for Digital Still Cameras) version 2.31, a standard in which information stored with photographs is used for optimal color reproduction when the images are output on Exif-compliant printers.
- **PictBridge:** A standard developed through cooperation with the digital camera and printer industries, allowing photographs to be output directly to a printer without first transferring them to a computer.
- **HDMI:** High-Definition Multimedia Interface is a standard for multimedia interfaces used in consumer electronics and AV devices capable of transmitting audiovisual data and control signals to HDMI-compliant devices via a single cable connection.

Approved Memory Cards

The camera supports SD, SDHC, and SDXC memory cards, including SDHC and SDXC cards compliant with UHS-I. Cards rated UHS Speed Class 3 or better are recommended for movie recording and playback; using slower cards may result in recording or playback being interrupted. When choosing cards for use in card readers, be sure they are compatible with the device. Contact the manufacturer for information on features, operation, and limitations on use.



Battery Endurance

The approximate length of footage or number of shots that can be recorded with a fully-charged EN-EL25 battery varies with the monitor mode.¹ The figures for photographs² are as follows:

- **Viewfinder only:** 280 shots
- **Monitor only:** 320 shots

The figures for movies³ are:

- **Viewfinder only:** 75 minutes
- **Monitor only:** 75 minutes

Actions such as the following can reduce battery endurance:

- Keeping the shutter-release button pressed halfway
- Repeated autofocus operations
- Taking NEF (RAW) photographs
- Slow shutter speeds
- Using camera Wi-Fi (wireless LAN) and Bluetooth features
- Using the camera with optional accessories connected
- Repeatedly zooming in and out
- Taking pictures at low ambient temperatures

To ensure that you get the most from rechargeable Nikon EN-EL25 batteries:

- Keep the battery contacts clean. Soiled contacts can reduce battery performance.
- Use batteries immediately after charging. Batteries will lose their charge if left unused.

- 1 Endurance varies with the condition of the battery, the temperature, the interval between shots, and the length of time menus are displayed.
- 2 CIPA standard. Measured at 23 °C/73.4 °F (± 2 °C/3.6 °F) with a NIKKOR Z DX 16–50mm f/3.5–6.3 VR lens under the following test conditions: one photograph taken at default settings once every 30 s.
- 3 Measured at 23 °C/73.4 °F (± 2 °C/3.6 °F) with the camera at default settings and a NIKKOR Z DX 16–50mm f/3.5–6.3 VR lens under conditions specified by the Camera and Imaging Products Association (CIPA). Individual movies can be up to 29 minutes 59 seconds in length; recording may end before these limits are reached if the camera temperature rises.

NIKKOR Z DX 16–50mm f/3.5–6.3 VR Lens

Note that lens kits may not be available in some countries or regions.

Using the Lens

■ Parts of the Lens: Names and Functions

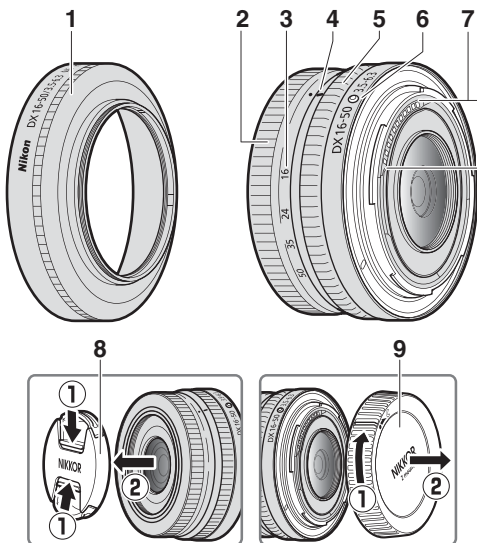

Note: The rear cap included with the lens that comes with the lens kit may differ from that shown, in which case it can be removed without performing Step ①.

- 1 Lens hood*
- 2 Zoom ring
- 3 Focal length scale
- 4 Focal length mark
- 5 Control ring

- 6 Lens mounting mark
- 7 CPU contacts
- 8 Front lens cap
- 9 Rear lens cap

* Available separately.

Specifications

Mount	Nikon Z mount
Focal length	16 – 50 mm
Maximum aperture	f/3.5 – 6.3
Lens construction	9 elements in 7 groups (including 1 ED element and 4 aspherical elements)
Angle of view	83°–31° 30' (DX image area)
Focal length scale	Graduated in millimeters (16, 24, 35, 50)
Focusing system	Internal focusing system
Vibration reduction	Lens shift using voice coil motors (VCMs)
Minimum focus distance (measured from focal plane)	<ul style="list-style-type: none"> • 16 mm zoom position: 0.25 m (0.82 ft) • 24 mm zoom position: 0.2 m (0.66 ft) • 35 mm zoom position: 0.23 m (0.76 ft) • 50 mm zoom position: 0.3 m (0.99 ft)
Maximum reproduction ratio	0.2×
Diaphragm blades	7 (rounded diaphragm opening)
Aperture range	<ul style="list-style-type: none"> • 16 mm zoom position: f/3.5 – 22 • 50 mm zoom position: f/6.3 – 40
Filter-attachment size	46 mm (P = 0.75 mm)
Dimensions	Approx. 70 mm/2.8 in. maximum diameter × 32 mm/1.3 in. (distance from camera lens mount flange when lens is retracted)
Weight	Approx. 135 g (4.8 oz)

Nikon reserves the right to change the appearance, specifications, and performance of this product at any time and without prior notice.

NIKKOR Z DX 50–250mm f/4.5–6.3 VR Lens

Note that lens kits may not be available in some countries or regions.

Using the Lens

■ Parts of the Lens: Names and Functions

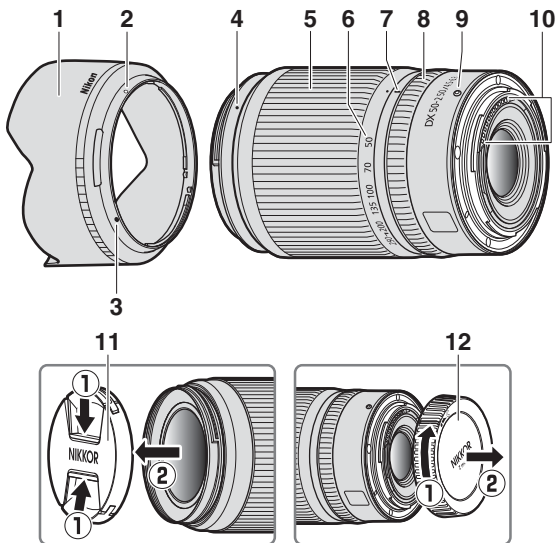

Note: The rear cap included with the lens that comes with the lens kit may differ from that shown, in which case it can be removed without performing Step ①.

- 1 Lens hood*
- 2 Lens hood lock mark
- 3 Lens hood alignment mark
- 4 Lens hood mounting mark
- 5 Zoom ring
- 6 Focal length scale

- 7 Focal length mark
- 8 Control ring
- 9 Lens mounting mark
- 10 CPU contacts
- 11 Front lens cap
- 12 Rear lens cap

* Available separately.

Specifications

Mount	Nikon Z mount
Focal length	50 – 250 mm
Maximum aperture	f/4.5 – 6.3
Lens construction	16 elements in 12 groups (including 1 ED element)
Angle of view	31° 30'–6° 30' (DX image area)
Focal length scale	Graduated in millimeters (50, 70, 100, 135, 200, 250)
Focusing system	Internal focusing system
Vibration reduction	Lens shift using voice coil motors (VCMs)
Minimum focus distance (measured from focal plane)	<ul style="list-style-type: none">• 50 mm zoom position: 0.5 m (1.64 ft)• 70 mm zoom position: 0.52 m (1.71 ft)• 100 mm zoom position: 0.58 m (1.91 ft)• 135 mm zoom position: 0.65 m (2.14 ft)• 200 mm zoom position: 0.83 m (2.73 ft)• 250 mm zoom position: 1.0 m (3.29 ft)
Maximum reproduction ratio	0.23×
Diaphragm blades	7 (rounded diaphragm opening)
Aperture range	<ul style="list-style-type: none">• 50 mm zoom position: f/4.5 – 22• 250 mm zoom position: f/6.3 – 32
Filter-attachment size	62 mm (P = 0.75 mm)
Dimensions	Approx. 74 mm/3 in. maximum diameter × 110 mm/4.4 in. (distance from camera lens mount flange when lens is retracted)
Weight	Approx. 405 g (14.3 oz)

Nikon reserves the right to change the appearance, specifications, and performance of this product at any time and without prior notice.

Notices

Notices for Customers in the U.S.A.

The Battery Charger

IMPORTANT SAFETY INSTRUCTIONS—SAVE THESE INSTRUCTIONS

DANGER—TO REDUCE THE RISK OF FIRE OR ELECTRIC SHOCK, CAREFULLY FOLLOW THESE INSTRUCTIONS

For connection to a supply not in the U.S.A., use an attachment plug adapter of the proper configuration for the power outlet if needed. This power unit is intended to be correctly oriented in a vertical or floor mount position.

Federal Communications Commission (FCC) Radio Frequency Interference Statement

This equipment has been tested and found to comply with the limits for a Class B digital device, pursuant to Part 15 of the FCC rules. These limits are designed to provide reasonable protection against harmful interference in a residential installation. This equipment generates, uses, and can radiate radio frequency energy and, if not installed and used in accordance with the instructions, may cause harmful interference to radio communications. However, there is no guarantee that interference will not occur in a particular installation. If this equipment does cause harmful interference to radio or television reception, which can be determined by turning the equipment off and on, the user is encouraged to try to correct the interference by one or more of the following measures:

- Reorient or relocate the receiving antenna.
- Increase the separation between the equipment and receiver.
- Connect the equipment into an outlet on a circuit different from that to which the receiver is connected.
- Consult the dealer or an experienced radio/television technician for help.



Nikon
Z 50

CAUTIONS

Modifications

The FCC requires the user to be notified that any changes or modifications made to this device that are not expressly approved by Nikon Corporation may void the user's authority to operate the equipment.

Interface Cables

Use the interface cables sold or provided by Nikon for your equipment. Using other interface cables may exceed the limits of Class B Part 15 of the FCC rules.

Nikon Inc., 1300 Walt Whitman Road, Melville, New York 11747-3064, U.S.A.
Tel.: 631-547-4200

Notice for Customers in Canada

CAN ICES-3 B / NMB-3 B

Notices for Customers in Europe

CAUTION: RISK OF EXPLOSION IF BATTERY IS REPLACED BY AN INCORRECT TYPE. DISPOSE OF USED BATTERIES ACCORDING TO THE INSTRUCTIONS.

This symbol indicates that electrical and electronic equipment is to be collected separately.



This symbol on the battery indicates that the battery is to be collected separately.



The following apply only to users in European countries:

- This product is designated for separate collection at an appropriate collection point. Do not dispose of as household waste.
- Separate collection and recycling helps conserve natural resources and prevent negative consequences for human health and the environment that might result from incorrect disposal.
- For more information, contact the retailer or the local authorities in charge of waste management.

The following apply only to users in European countries:

- All batteries, whether marked with this symbol or not, are designated for separate collection at an appropriate collection point. Do not dispose of as household waste.
- For more information, contact the retailer or the local authorities in charge of waste management.

Bluetooth and Wi-Fi (Wireless LAN)

This product is controlled by the United States Export Administration Regulations (EAR). The permission of the United States government is not required for export to countries other than the following, which as of this writing are subject to embargo or special controls: Cuba, Iran, North Korea, Sudan, and Syria (list subject to change).

The use of wireless devices may be prohibited in some countries or regions. Contact a Nikon-authorized service representative before using the wireless features of this product outside the country of purchase.

The Bluetooth transmitter in this device operates in the 2.4 GHz band.

Notice for Customers in the U.S.A. and Canada

This device complies with part 15 of FCC Rules and Innovation, Science and Economic Development Canada's licence-exempt RSSs. Operation is subject to the following two conditions: (1) this device may not cause harmful interference, and (2) this device must accept any interference received, including interference that may cause undesired operation.

FCC WARNING

The FCC requires the user to be notified that any changes or modifications made to this device that are not expressly approved by Nikon Corporation may void the user's authority to operate the equipment.

Compliance with FCC requirement 15.407(c)

Data transmission is always initiated by software, which is then passed down through the MAC, through the digital and analog baseband, and finally to the RF chip. Several special packets are initiated by the MAC. These are the only ways the digital baseband portion will turn on the RF transmitter, which it then turns off at the end of the packet. Therefore, the transmitter will be on only while one of the aforementioned packets is being transmitted. In other words, this device automatically discontinues transmission in case of either absence of information to transmit or operational failure.

Frequency Tolerance: ± 20 ppm

FCC Radio Frequency Interference Statement

Note: This equipment has been tested and found to comply with the limits for a Class B digital device, pursuant to part 15 of the FCC Rules. These limits are designed to provide reasonable protection against harmful interference in a residential installation. This equipment generates, uses and can radiate radio frequency energy and, if not installed and used in accordance with the instructions, may cause harmful interference to radio communications. However, there is no guarantee that interference will not occur in a particular installation. If this equipment does cause harmful interference to radio or television reception, which can be determined by turning the equipment off and on, the user is encouraged to try to correct the interference by one or more of the following measures:

- Reorient or relocate the receiving antenna.
- Increase the separation between the equipment and receiver.
- Connect the equipment into an outlet on a circuit different from that to which the receiver is connected.
- Consult the dealer or an experienced radio/TV technician for help.

Co-location

This transmitter must not be co-located or operated in conjunction with any other antenna or transmitter.

Nikon Inc., 1300 Walt Whitman Road, Melville, New York 11747-3064, U.S.A.
Tel.: 631-547-4200

FCC/ISED RF Exposure Statement

The available scientific evidence does not show that any health problems are associated with using low power wireless devices. There is no proof, however, that these low power wireless devices are absolutely safe. Low power Wireless devices emit low levels of radio frequency energy (RF) in the microwave range while being used. Whereas high levels of RF can produce health effects (by heating tissue), exposure of low-level RF that does not produce heating effects causes no known adverse health effects. Many studies of low-level RF exposures have not found any biological effects. Some studies have suggested that some biological effects might occur, but such findings have not been confirmed by additional research. This product has been tested and found to comply with FCC/ISED radiation exposure limits set forth for an uncontrolled environment and meets the FCC radio frequency (RF) Exposure Guidelines and RSS-102 of the ISED radio frequency (RF) Exposure rules. Please refer to the SAR test report that was uploaded to FCC website.

Compliance with RSS-247 Issue 2 §6.4

Data transmission is always initiated by software, which is the passed down through the MAC, through the digital and analog baseband, and finally to the RF chip. Several special packets are initiated by the MAC. These are the only ways the digital baseband portion will turn on the RF transmitter, which it then turns off at the end of the packet. Therefore, the transmitter will be on only while one of the aforementioned packets is being transmitted. In other words, this device automatically discontinues transmission in case of either absence of information to transmit or operational failure.

Notice for Customers in Canada

For indoor use only (5150-5350MHz).

Notice for Customers in Europe and in Countries Complying with the Radio Equipment Directive

Hereby, Nikon Corporation declares that the radio equipment type Z 50 is in compliance with Directive 2014/53/EU.



The full texts of the EU declarations of conformity are available at the following internet addresses:

https://imaging.nikon.com/support/pdf/DoC_N1912.pdf

Notice for Customers in Singapore

Trade Name: **Nikon**
Model: Z 50

This device complies with radio-frequency regulations. The content of certification labels not affixed to the device is given below.

Complies with
IMDA Standards
DA103423

Notice for Customers in Nigeria

Connection and use of this communications
equipment is permitted by the Nigerian
Communications Commission

Security

Although one of the benefits of this product is that it allows others to freely connect for the wireless exchange of data anywhere within its range, the following may occur if security is not enabled:

- **Data theft:** Malicious third-parties may intercept wireless transmissions to steal user IDs, passwords, and other personal information.
- **Unauthorized access:** Unauthorized users may gain access to the network and alter data or perform other malicious actions. Note that due to the design of wireless networks, specialized attacks may allow unauthorized access even when security is enabled.
- **Unsecured networks:** Connecting to open networks may result in unauthorized access. Use secure networks only.

Conformity Marking

The standards with which the camera complies can be viewed using the **Conformity marking** option in the setup menu.

Certificates

• ประเทศไทย

เครื่อง โทรคมนาคมและอุปกรณ์นี้ มีความสอดคล้องตาม
ข้อกำหนดของ กสทช

• Maroc/

المغرب

AGREE PAR L'ANRT MAROC
Numéro d'agrément : MR 20136 ANRT 2019

• México

IFETEL: RCPMU1M18-0171
1MW

La operación de este equipo está sujeta a las siguientes
dos condiciones:

- (1) es posible que este equipo o dispositivo no cause
interferencia perjudicial y
- (2) este equipo o dispositivo debe aceptar cualquier
interferencia, incluyendo la que pueda causar su
operación no deseada.

• Paraguay



CONATEL

Emap S.A. (Casa Nissei)

Avda Adrian Jara, Esq. Regimiento Piribebuy, Ciudad
del Este, Paraguay.

Tel: 595 61 500 115

Fax: 595 61 500 115

• عمان

Oman-TRA
D090024
R/7832/19

• الإمارات العربية المتحدة

TRA
REGISTERED No:
ER61596/18
DEALER No:
DA39487/15

Trademarks and Licenses

Trademark Information

IOS is a trademark or registered trademark of Cisco Systems, Inc., in the United States and/or other countries and is used under license. Windows is either a registered trademark or a trademark of Microsoft Corporation in the United States and/or other countries. Mac, macOS, OS X, Apple®, App Store®, the Apple logos, iPhone®, iPad®, and iPod touch® are trademarks of Apple Inc. registered in the U.S. and/or other countries. Android, Google Play and the Google Play logo are trademarks of Google LLC. The Android robot is reproduced or modified from work created and shared by Google and used according to terms described in the Creative Commons 3.0 Attribution License. PictBridge is a trademark of the Camera and Imaging Products Association (CIPA). The SD, SDHC, and SDXC logos are trademarks of the SD-3C, LLC. HDMI, the HDMI logo and High-Definition Multimedia Interface are trademarks or registered trademarks of HDMI Licensing, LLC.

HDMI

Wi-Fi and the Wi-Fi logo are trademarks or registered trademarks of the Wi-Fi Alliance. The Bluetooth® word mark and logos are registered trademarks owned by Bluetooth SIG, Inc. and any use of such marks by Nikon Corporation is under license.

All other trade names mentioned in this manual or the other documentation provided with your Nikon product are trademarks or registered trademarks of their respective holders.

Use of the Made for Apple badge means that an accessory has been designed to connect specifically to the Apple products identified in the badge, and has been certified by the developer to meet Apple performance standards. Apple is not responsible for the operation of this device or its compliance with safety and regulatory standards. Please note that the use of this accessory with an Apple product may affect wireless performance.

FreeType License (FreeType2)

Portions of this software are copyright © 2012 The FreeType Project (<https://www.freetype.org>). All rights reserved.

MIT License (HarfBuzz)

Portions of this software are copyright © 2018 The HarfBuzz Project (<https://www.freedesktop.org/wiki/Software/HarfBuzz>). All rights reserved.

AVC Patent Portfolio License

THIS PRODUCT IS LICENSED UNDER THE AVC PATENT PORTFOLIO LICENSE FOR THE PERSONAL AND NON-COMMERCIAL USE OF A CONSUMER TO (i) ENCODE VIDEO IN COMPLIANCE WITH THE AVC STANDARD (“AVC VIDEO”) AND/OR (ii) DECODE AVC VIDEO THAT WAS ENCODED BY A CONSUMER ENGAGED IN A PERSONAL AND NON-COMMERCIAL ACTIVITY AND/OR WAS OBTAINED FROM A VIDEO PROVIDER LICENSED TO PROVIDE AVC VIDEO. NO LICENSE IS GRANTED OR SHALL BE IMPLIED FOR ANY OTHER USE. ADDITIONAL INFORMATION MAY BE OBTAINED FROM MPEG LA, L.L.C. SEE <https://www.mpegla.com>

Unicode® Character Database License (Unicode® Character Database)

This software incorporates Unicode® Character Database open-source code. The license for this open-source code is given below.

COPYRIGHT AND PERMISSION NOTICE

Copyright © 1991-2019 Unicode, Inc. All rights reserved.

Distributed under the Terms of Use in

<https://www.unicode.org/copyright.html>.

Permission is hereby granted, free of charge, to any person obtaining a copy of the Unicode data files and any associated documentation (the "Data Files") or Unicode software and any associated documentation (the "Software") to deal in the Data Files or Software without restriction, including without limitation the rights to use, copy, modify, merge, publish, distribute, and/or sell copies of the Data Files or Software, and to permit persons to whom the Data Files or Software are furnished to do so, provided that either

- (a) this copyright and permission notice appear with all copies of the Data Files or Software, or
- (b) this copyright and permission notice appear in associated Documentation.

THE DATA FILES AND SOFTWARE ARE PROVIDED "AS IS", WITHOUT WARRANTY OF ANY KIND, EXPRESS OR IMPLIED, INCLUDING BUT NOT LIMITED TO THE WARRANTIES OF MERCHANTABILITY, FITNESS FOR A PARTICULAR PURPOSE AND NONINFRINGEMENT OF THIRD PARTY RIGHTS.

IN NO EVENT SHALL THE COPYRIGHT HOLDER OR HOLDERS INCLUDED IN THIS NOTICE BE LIABLE FOR ANY CLAIM, OR ANY SPECIAL INDIRECT OR CONSEQUENTIAL DAMAGES, OR ANY DAMAGES WHATSOEVER RESULTING FROM LOSS OF USE, DATA OR PROFITS, WHETHER IN AN ACTION OF CONTRACT, NEGLIGENCE OR OTHER TORTIOUS ACTION, ARISING OUT OF OR IN CONNECTION WITH THE USE OR PERFORMANCE OF THE DATA FILES OR SOFTWARE.

Except as contained in this notice, the name of a copyright holder shall not be used in advertising or otherwise to promote the sale, use or other dealings in these Data Files or Software without prior written authorization of the copyright holder.

Warranty Terms - Nikon Europe Service Warranty

Dear Nikon Customer,

We thank you for your purchasing this Nikon product. Should your Nikon product require warranty service, please contact the dealer from whom it was purchased or a member of our authorized service network within the sales territory of Nikon Europe B.V. (e.g. Europe/Russia/others). See details under: <https://www.europe-nikon.com/support>

In order to avoid any unnecessary inconvenience, we advise you to read the user manuals carefully before contacting the dealer or our authorized service network.

Your Nikon equipment is guaranteed against any manufacturing defects for one full year from the date of original purchase. If during this period of guarantee the product proves defective due to improper material or workmanship, our authorized service network within the sales territory of Nikon Europe B.V. will, without charge for labor and parts, repair the product in the terms and conditions set as below. Nikon reserves the right (at its sole discretion) to replace or repair the product.

1. This warranty is only provided upon presentation of the completed warranty card and original invoice or purchase receipt indicating the date of purchase, product type and dealer's name, together with the product. Nikon reserves the right to refuse free-of-charge warranty service if the above documents cannot be presented or if the information contained in it is incomplete or illegible.

2. This warranty will not cover:

- necessary maintenance and repair or replacement of parts due to normal wear and tear.
- modifications to upgrade the product from its normal purpose as described in user manuals, without the prior written consent of Nikon.
- transport costs and all risks of transport relating directly or indirectly to the warranty of the products.
- any damage resulting from modifications or adjustments which may be made to the product, without the prior written consent of Nikon, in order to comply with local or national technical standards in force in any other country than the ones for which the product was originally designed and/or manufactured.

3. The warranty will not be applicable in the case of:

- damage caused by misuse including but not limited to failure to use the product for its normal purpose or according to the user instructions on the proper use and maintenance, and to installation or use of the product inconsistent with the safety standards in force in the country where it is used.
- damage caused by accidents including but not limited to lightning, water, fire, misuse or neglect.
- defacing, illegibility or removal of the model or serial number on the product.
- damage resulting from repairs or adjustments which have been conducted by unauthorized service organizations or persons.
- defects in any system into which the product is incorporated or with which it is used.

4. This service warranty does not affect the consumer's statutory rights under applicable national laws in force, nor the consumer's right against the dealer arising from their sales/ purchase contract.

Notice: An overview of all authorized Nikon Service Stations can be found online by following this Link
(URL = <https://www.europe-nikon.com/service/>).

Nikon Europe Service Warranty Card

Model name

Nikon Z 50

Serial No.

Purchase date

■ Name and address of customer

■ Dealer

■ Distributor

Nikon Europe B.V.
Tripolis 100, Burgerweeshuispad 101,
1076 ER Amsterdam, The Netherlands

■ Manufacturer

NIKON CORPORATION
Shinagawa Intercity Tower C, 2-15-3, Konan,
Minato-ku, Tokyo 108-6290 Japan

No reproduction in any form of this manual, in whole or in part (except for brief quotation in critical articles or reviews), may be made without written authorization from NIKON CORPORATION.

NIKON CORPORATION

© 2019 Nikon Corporation

AMA16997

Printed in Europe



SB9101(11)
6MOA3611-01