

- Montageanleitung -
- Assembly instructions -
- Notice de montage -
- Montagehandleiding -
- Návod na montáž -
- Instrucțiune de montaj -
- Navodila za namestitev -
- Installationstruktioneer -

V1116-20-21, V1116-20-30, V1117-20-21
V1116-20-04, V1117-20-04, V1117-20-30

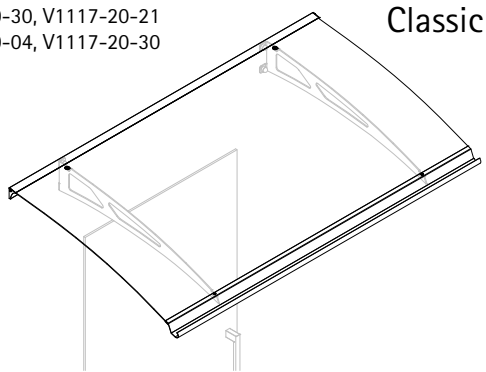

Classic

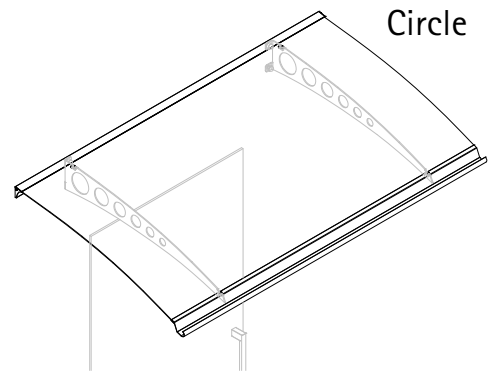

Circle

1600mm

V1120-20-21, V1121-20-21, V1120-20-30
V1120-20-04, V1121-20-04, V1121-20-30

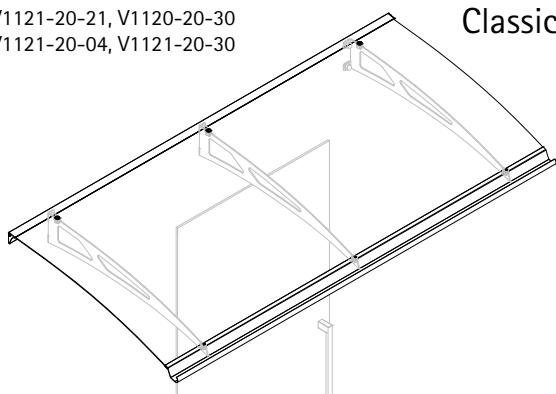

Classic

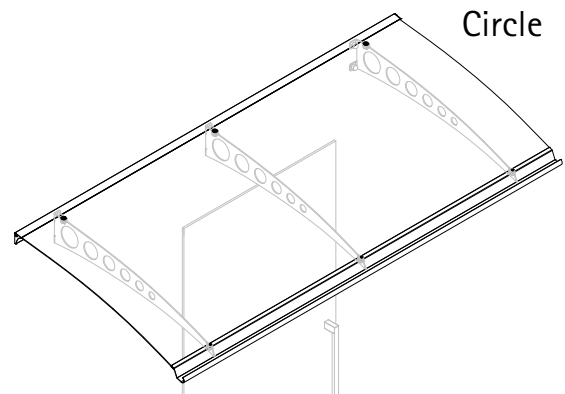

Circle

2000mm

V1124-20-21, V1124-20-30, V1125-20-04
V1124-20-04, V1125-20-21, V1125-20-30

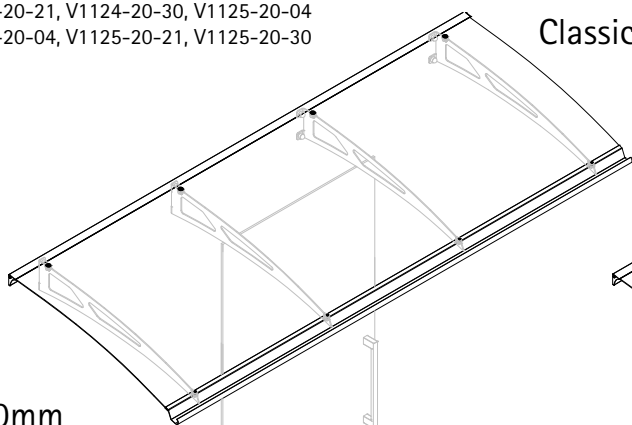

Classic

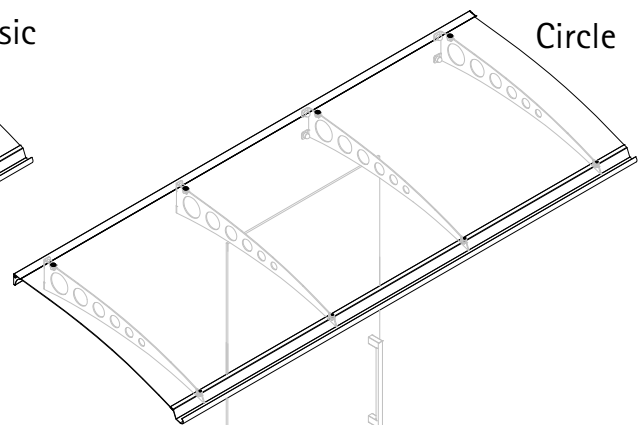

Circle

2400mm

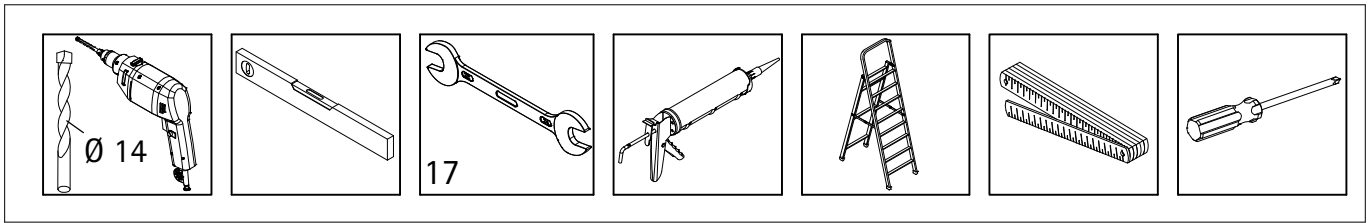

1600 mm

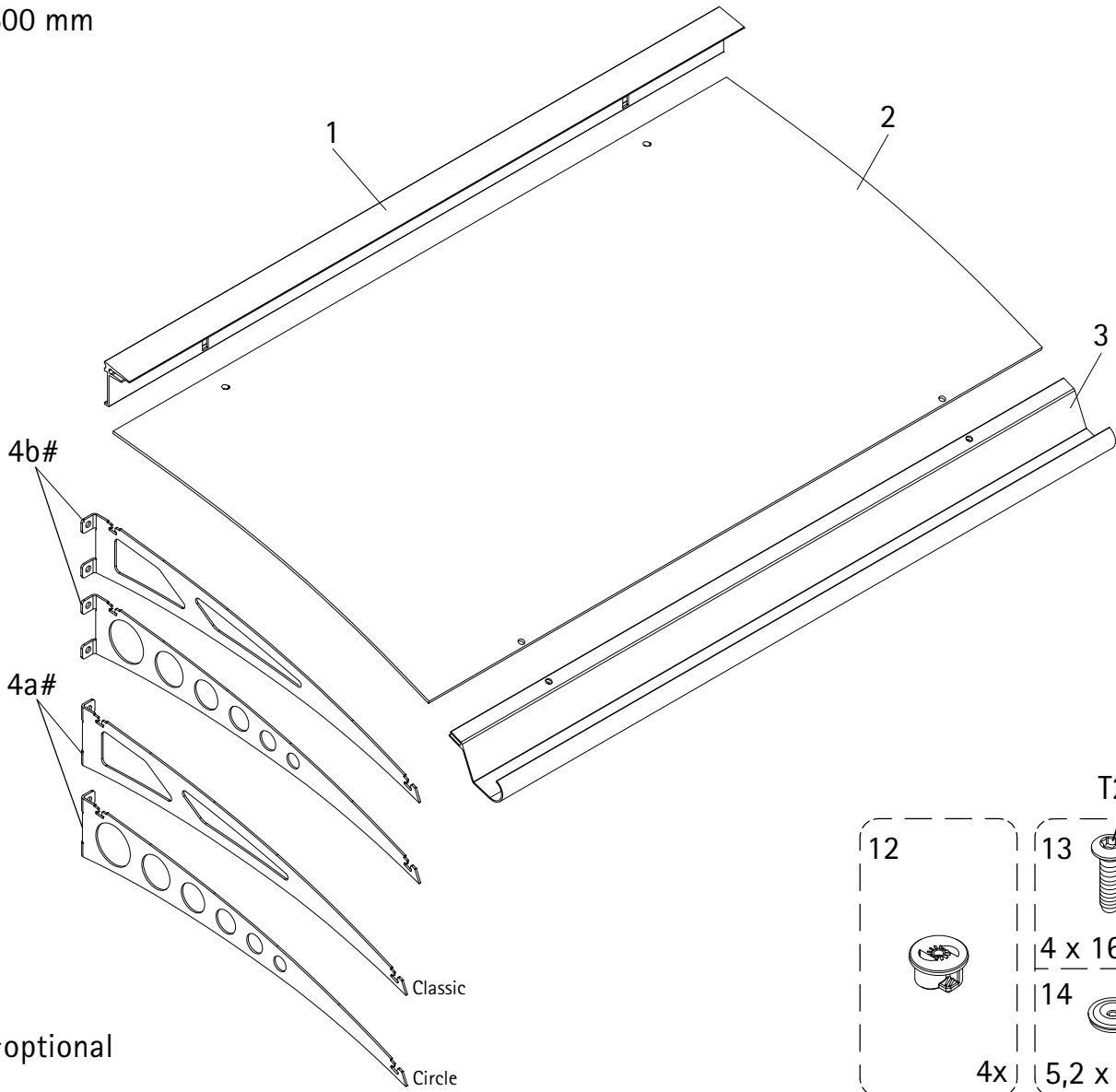

#optional

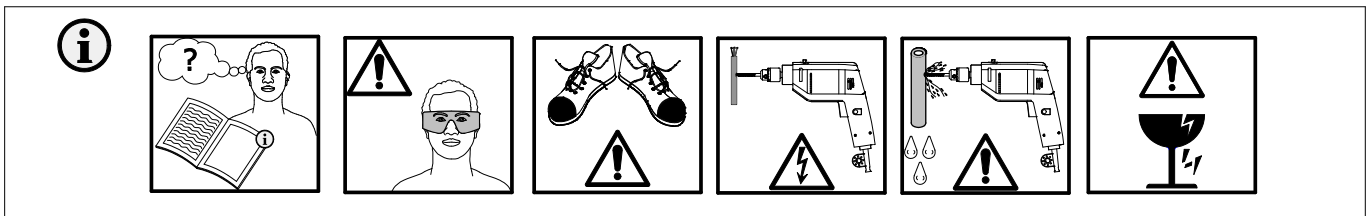
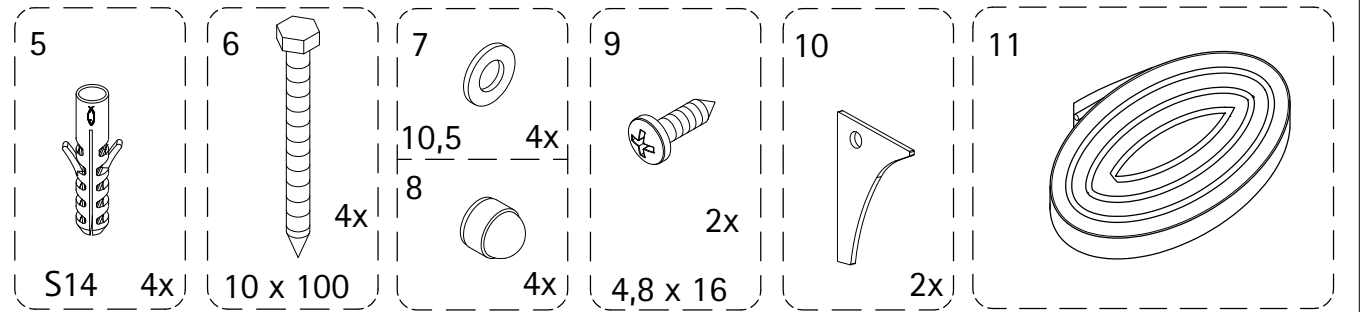

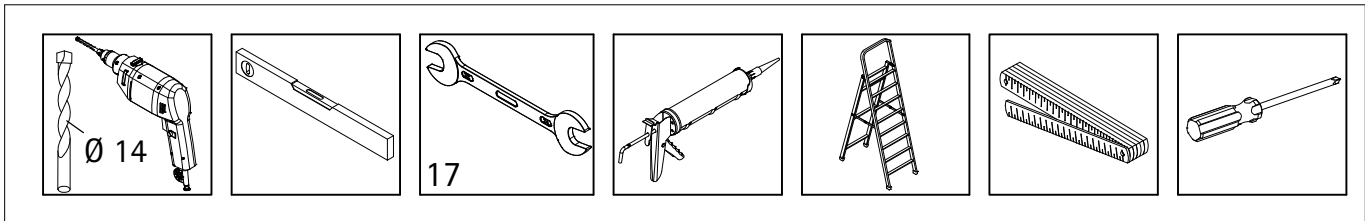

2000 mm

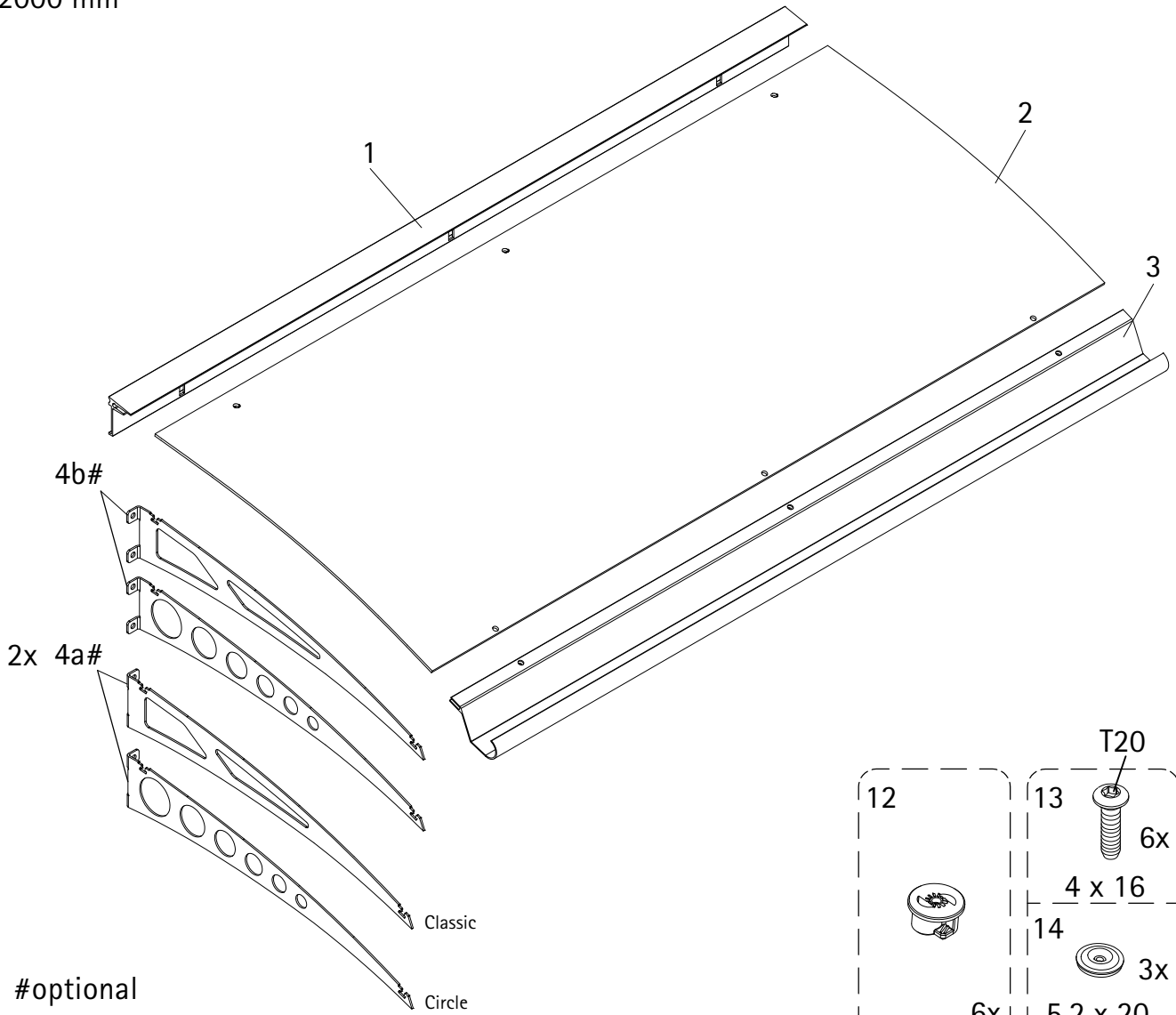

#optional

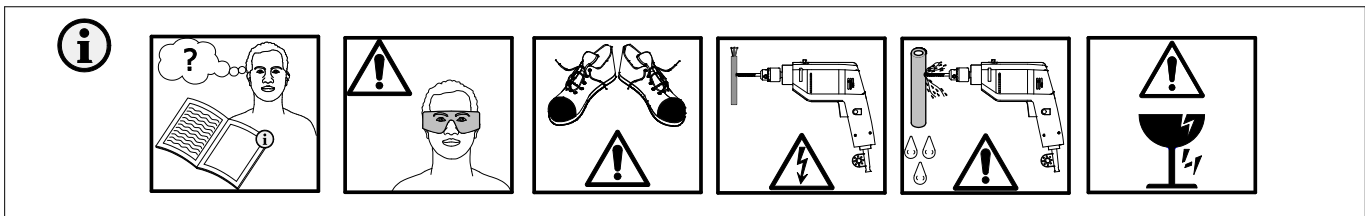
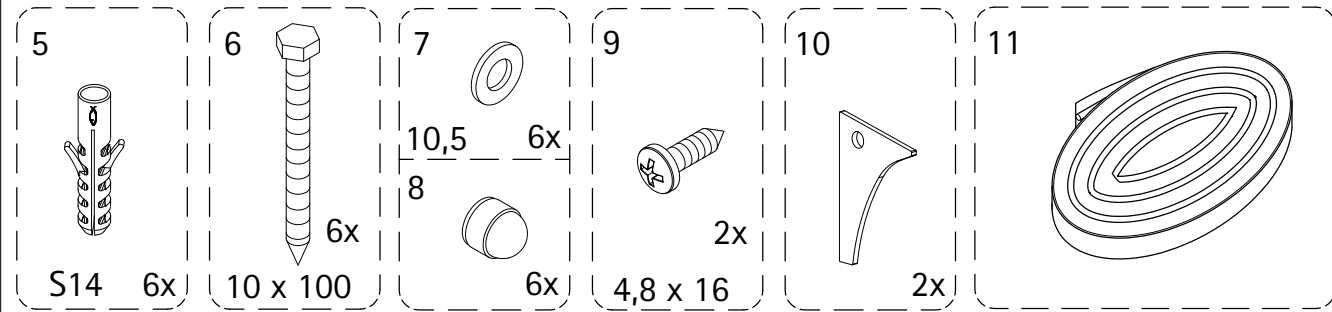

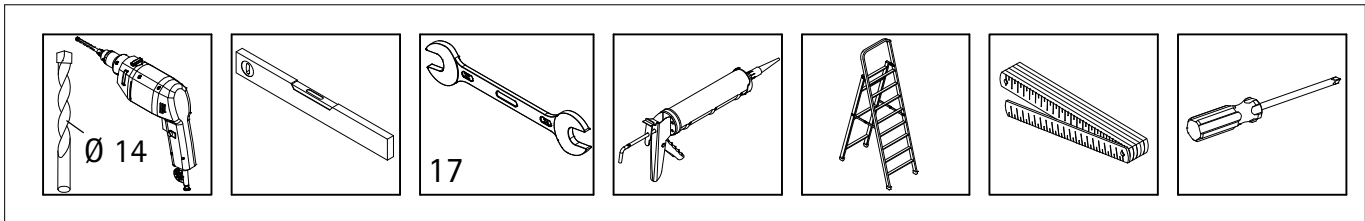

2400 mm

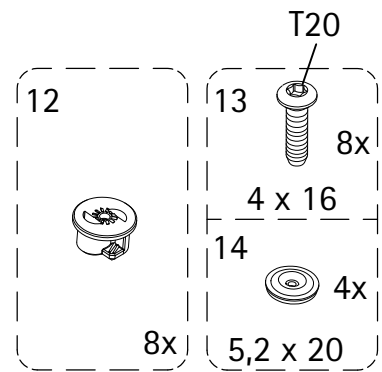
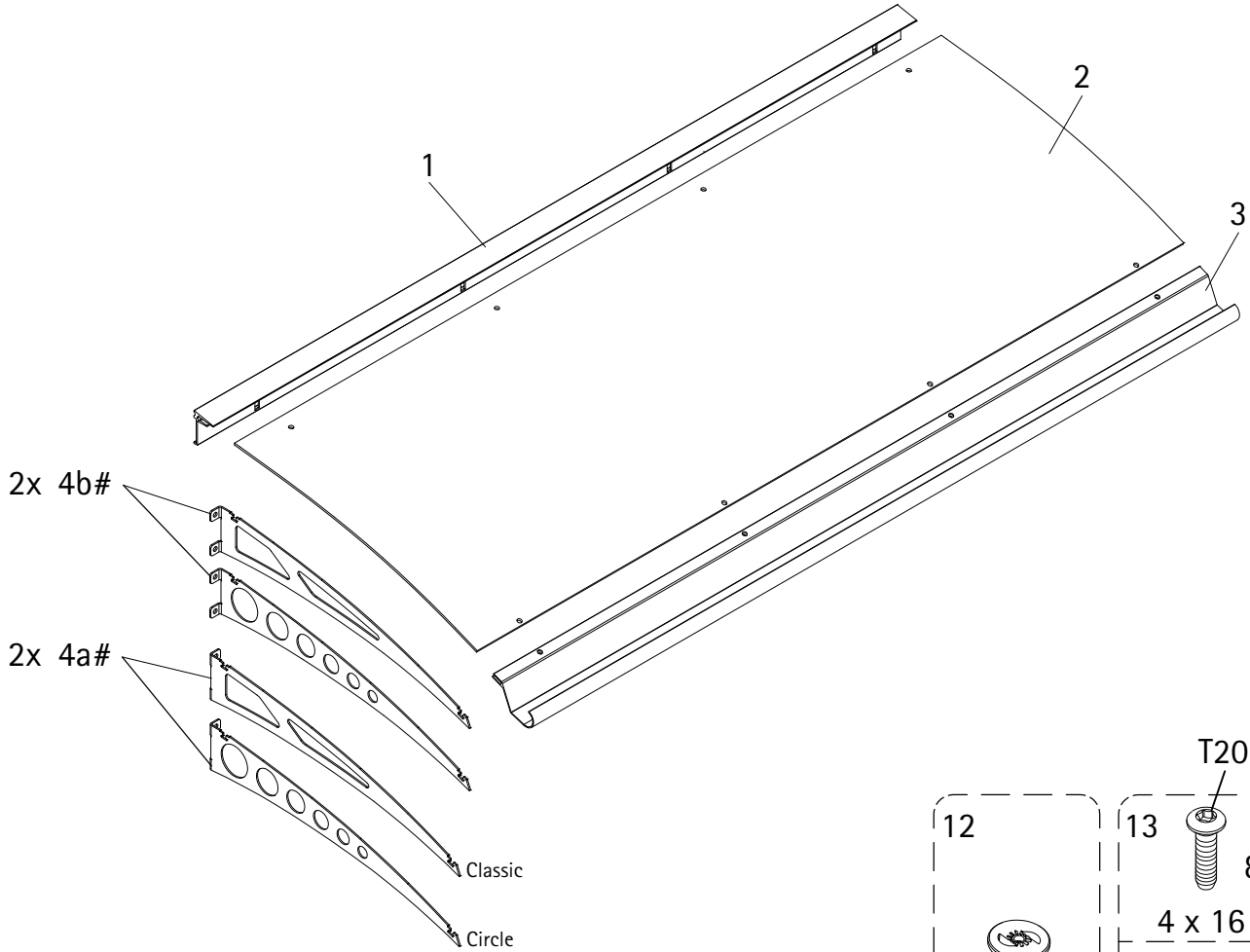

#optional

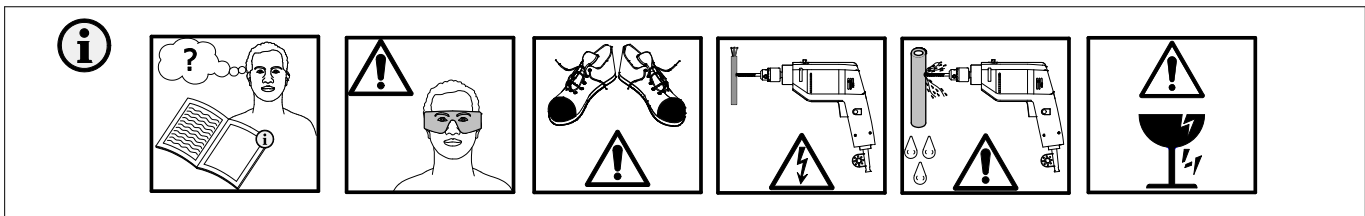
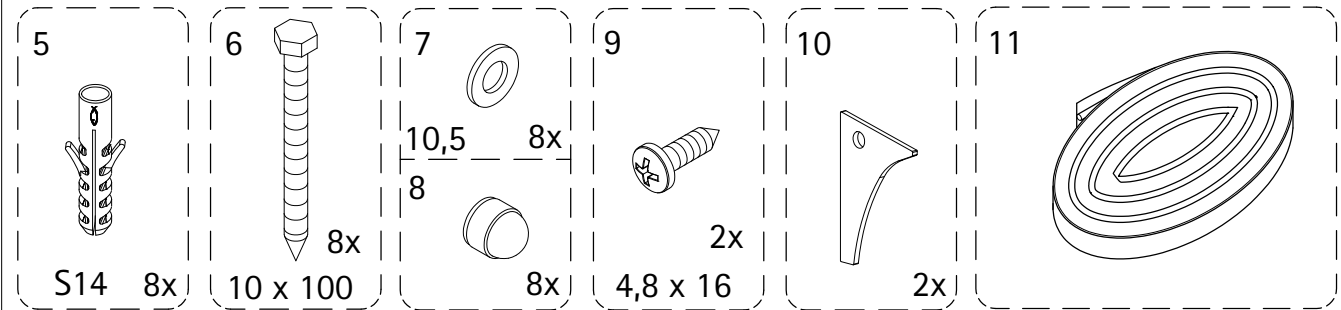

Deutsch

Achtung!

Vor Montage des Daches bitte die Beschaffenheit Ihres Mauerwerks überprüfen. Ggf. müssen andere Schrauben und Dübel verwendet werden, als im beigefügten Montage-Set enthalten sind (z.B. Hohlraumdübel o.ä.).

Reinigungshinweis:

Acrylglas/Polycarbonat und Metall nicht mit lösungsmittelhaltigen oder scheuernden Reinigungsmitteln bearbeiten. Verwenden Sie nur eine milde Seifenlauge mit einem weichen, nicht scheuernden Tuch.

Français

Attention!

Avant de fixer votre auvent, veillez à contrôler la maçonnerie pour chaque cas particulier. Vous pouvez éventuellement être amené à utiliser des chevilles et vis autres que celles fournies dans le set de montage ci-joint (par exemple des chevilles pour matériaux creux).

Conseil de nettoyage:

Pour l'entretien des parties métalliques ou du verre acrylique/polycarbonate, ne pas utiliser de produit contenant un agent à base de solvant ou décapant. Veuillez seulement utiliser un produit nettoyant non agressif et frotter avec un chiffon doux.

Svenska

Observera!

Kontrollera murverkets beskaffenhet innan panelen monteras. Eventuellt måste andra skruvar och pluggar (till exempel hålrumsplogg) än de som ingår i monteringsseten användas.

Rengöringsanvisning:

Rengör inte akrylglas/polycarbonat et och metallerna med lösningsmedels haltiga eller slipande rengöringsmedel. Använd bara en mild såplösning tillsammans med en mjuk trasa som inte repar materialet.

Česky

Pozor!

Před montáží clony nebo postranné části zkontrolujte kvalitu Vašeho zdiva. Popřípadě je nutné použít jiné šrouby a hmoždíky (např. dutinové hmoždíky), než byly přiloženy montážní soupravě.

Pokyny pro čištění:

Pro acrylové sklo/polykarbonátový a kov nepoužívejte čisticí prostředky obsahující ředidlo nebo prostředky nadřhnutí. Používejte jen jemný mýdlový roztok a měkkou, nedřhnoucí hadru.

English

Warning!

Please verify what type of wall you are dealing with before installing the canopy. If necessary, you may need to use other screws and anchors (e.g. drywall anchors or similar) than those included in the enclosed installation kit.

Cleaning instructions:

Do not use cleaners containing solvents or abrasive cleaners on acrylic glass/polycarbonate and metal. Please only use a mild soap solution with a soft, non-abrasive cloth.

Nederlands

Waarschuwing!

Controleer met wat voor type muur u te maken heeft voor u begint met de montage van het afdak. Het kan mogelijk zijn dat u andere schroeven en pluggen moet gebruiken dan die geleverd zijn in de montageset (bijvoorbeeld speciale pluggen voor een gipsen wand).

Schoonmaak advies:

Acrylglas/polycarbonaat en metaal niet behandelen met oplosmiddelen of schuurmiddelen. Gebruik slechts een milde zeepoplossing met een zachte doek.

Slovenščina

Pozor!

Pred montažo strehe elementa preverite kakovost vaših zidov. V nekaterih primerih moramo uporabiti drugačne vijake in elemente za pritrdjevanje (npr. pritrdjevalne elemente za razpoke in podobno) od pribora, vsebovanega v montažnem setu.

Opomba glede čiščenja:

Akrilno steklo/polykarbonátový in kovine ne smemo obdelovati s čistilnimi sredstvi, ki vsebujejo razredčila ali razjedajoče tekočine. Uporabljamo lahko samo blage milnice in mehko, neribajočo krpo.

România

Atenție!

Înainte de montaj a acoperișului sau membrul lateral controlați constituția zidului. Probabil este necesar să folosiți alte șuruburi și dibluri, ca acele care sînt în set de montaj.

Instrucțiuni de curățare:

Sticla acrilică, policarbonat și metal nu se curăță cu detergenți pe bază de solvenți sau abrazive. Folosiți numai apă și săpun, cu o cârpă moale, frisoane.

1

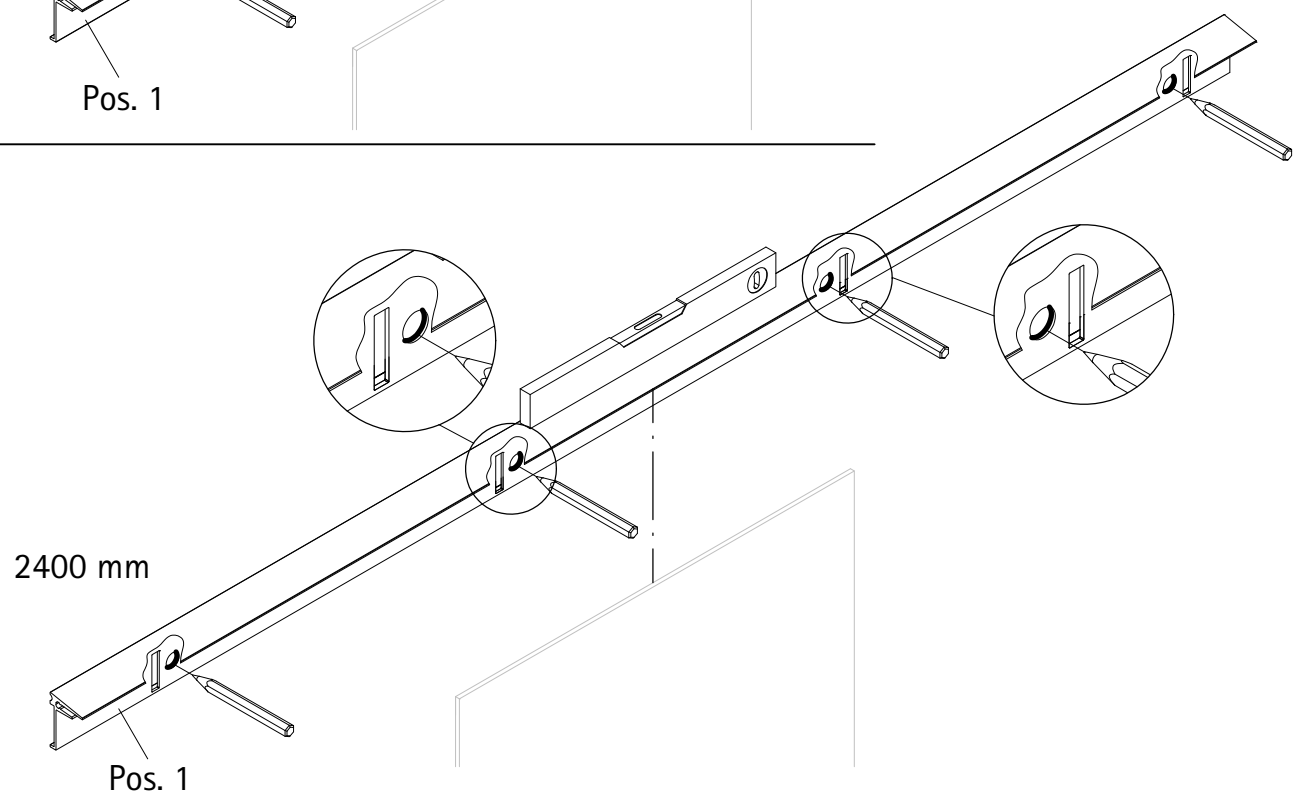
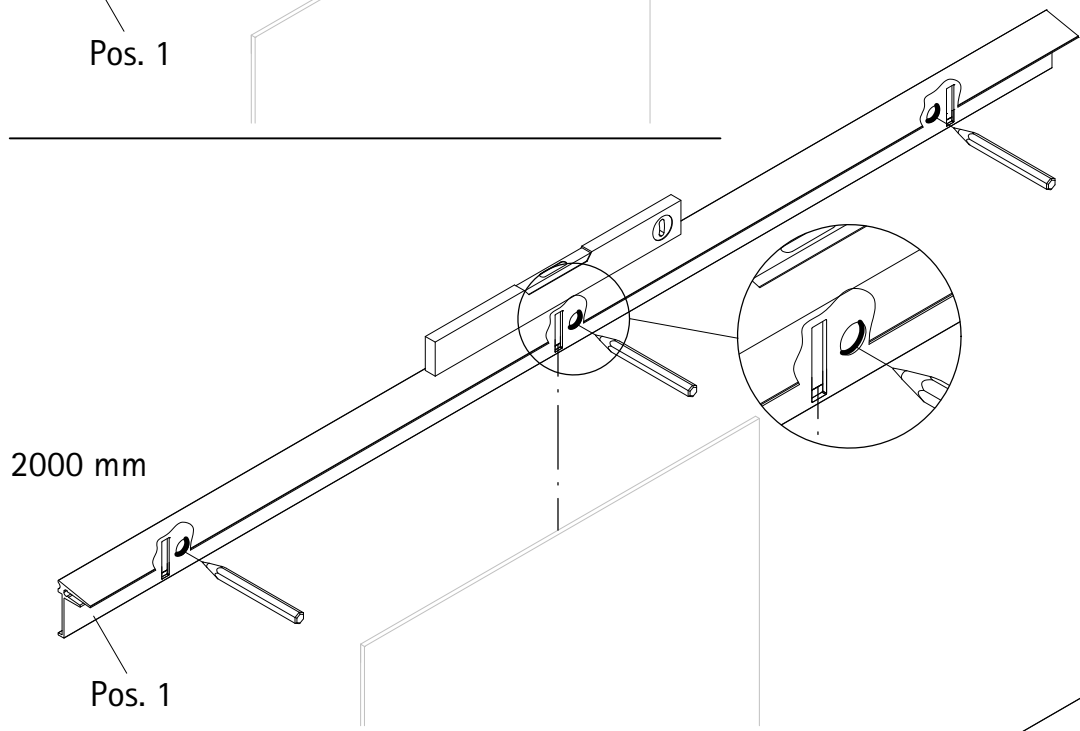
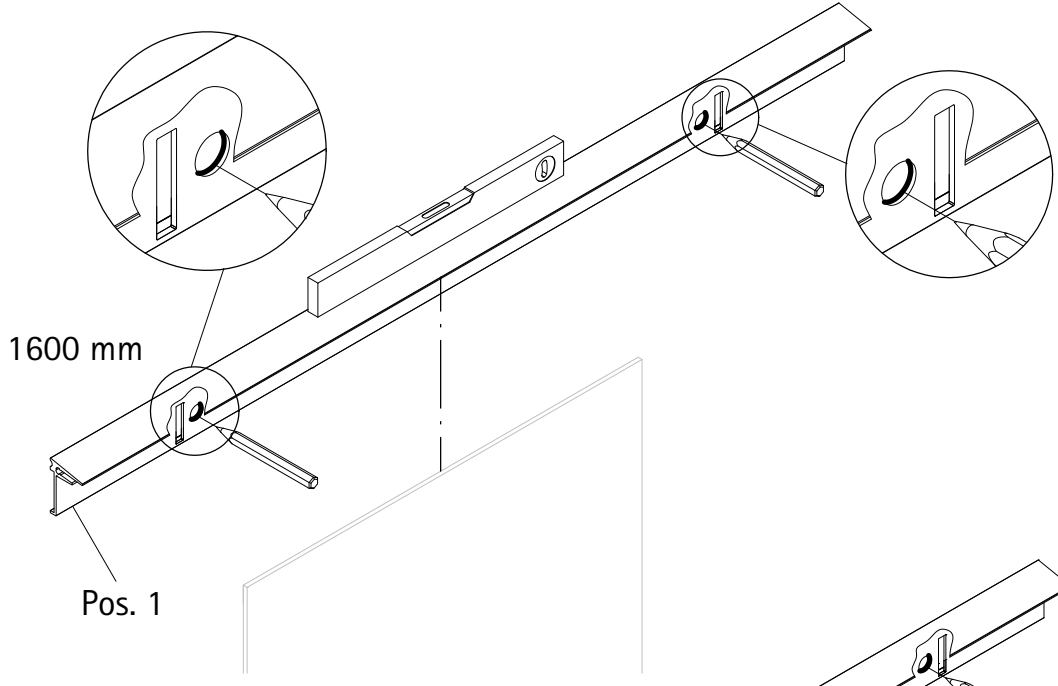

2

1600 mm

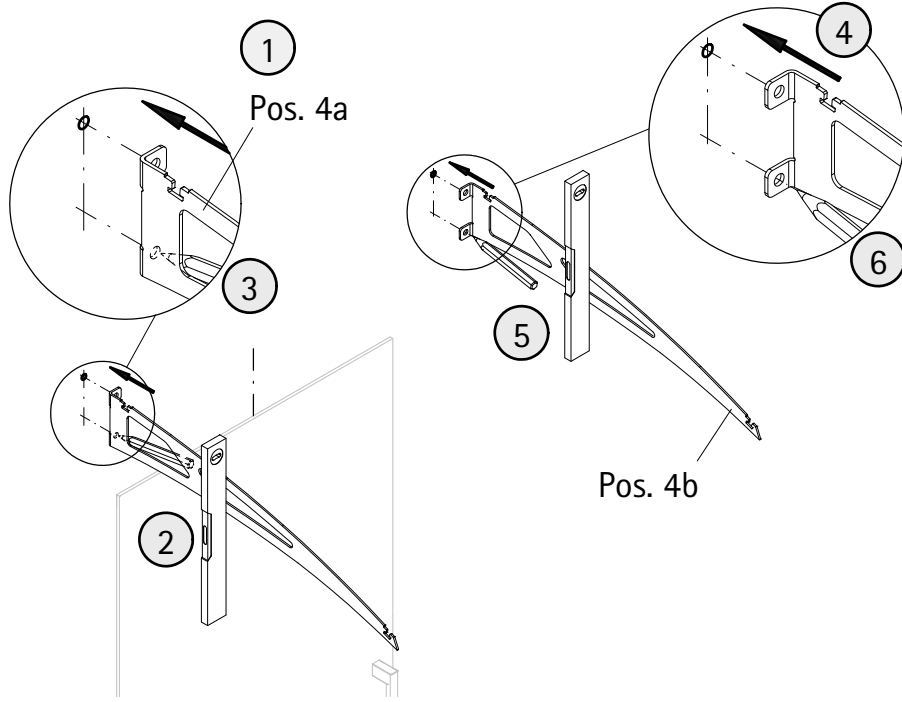

2000 mm

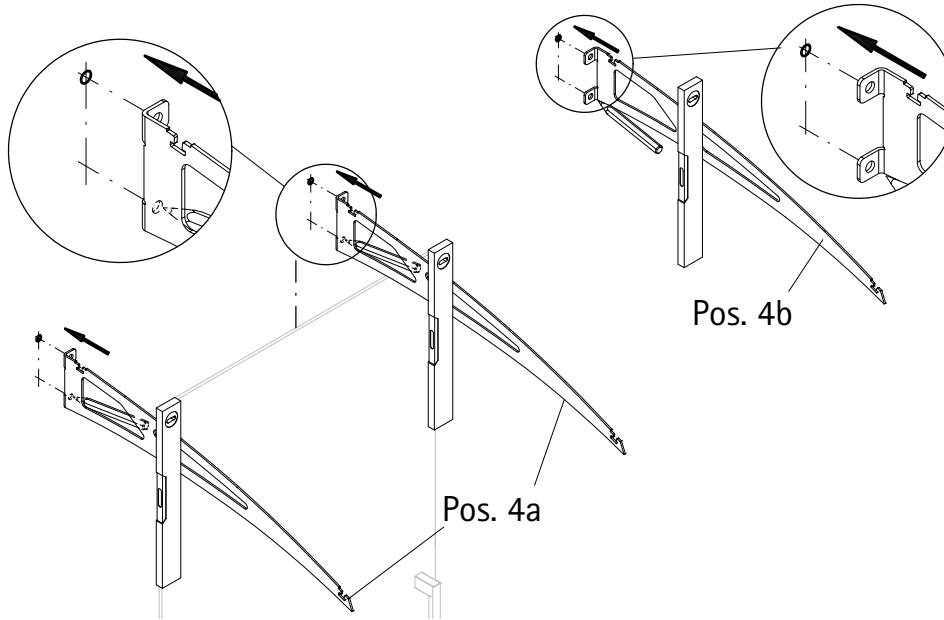

2400 mm

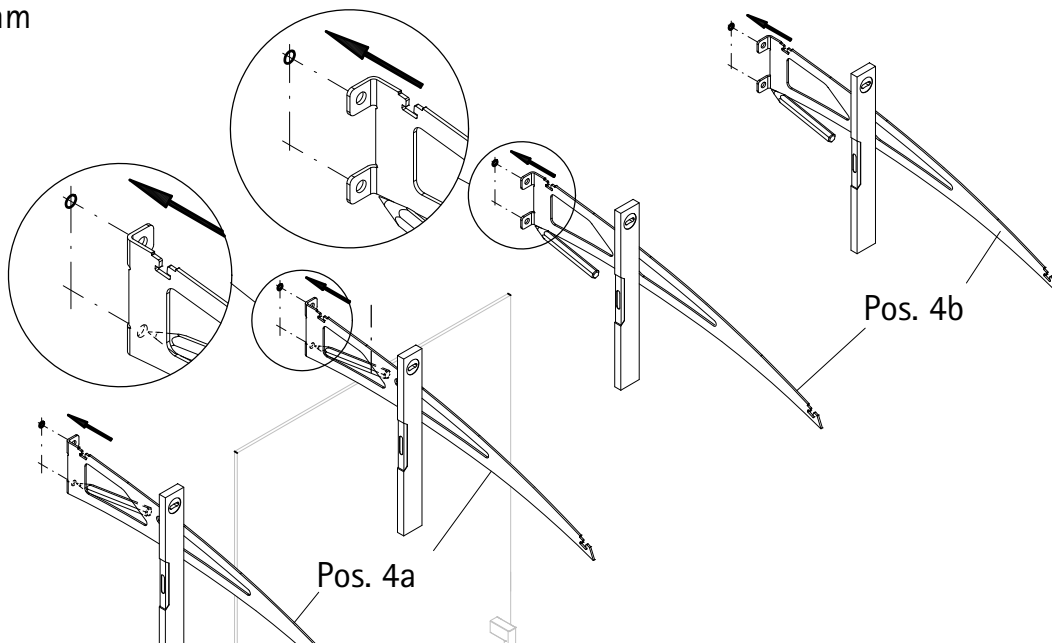

3

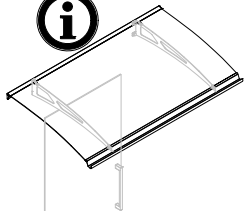

1

Ø 14 mm

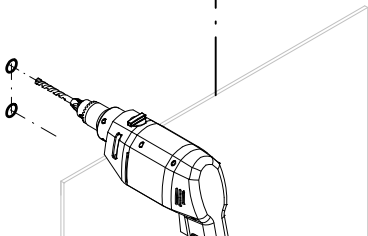
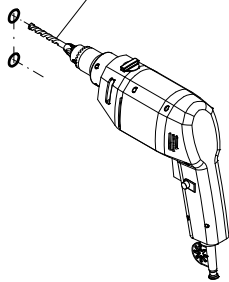

2

Pos. 5

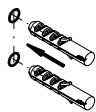
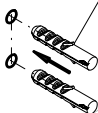
**Achtung!**

Das im Lieferumfang erhaltene Befestigungsmaterial ist ausschließlich für ungerissene Betonwände geeignet.

Let op!

Het bij de levering inbegrepen bevestigingsmateriaal is uitsluitend geschikt voor niet gescheurde betonwanden.

Pazar!

Pripevňovací materiál, jež je součástí dodávky, je vhodný pouze pro betonové stěny bez prasklin.

Attention!

Les pièces de fixation incluses dans ce colis sont uniquement destinées à des murs en béton non fissurés.

Opozorilo!

Pripevňovací materiál, jež je součástí dodávky, je vhodný pouze pro betonové stěny bez prasklin.

Atenție!

Materialul de fixare, care este inclus în pachet, este potrivit doar pentru pereți din beton fără crăpături.

Attention!

The delivered fixing materials is exclusively to be used for intact concrete walls.

OBS!

Fastställandet material som tillhandahålls är endast avsedd för osprucken betongväggar.

4

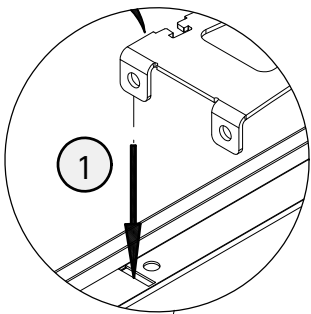

1

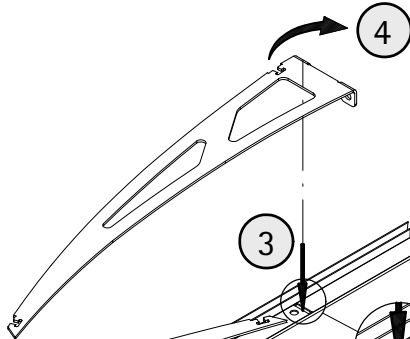

4

3

2

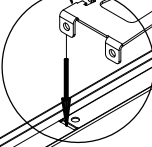

4

5

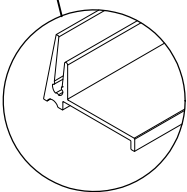

5

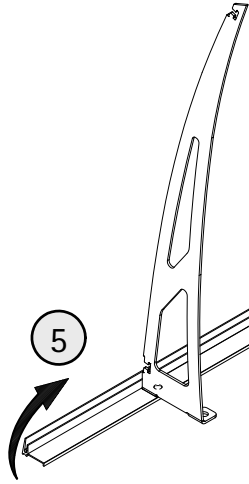

5

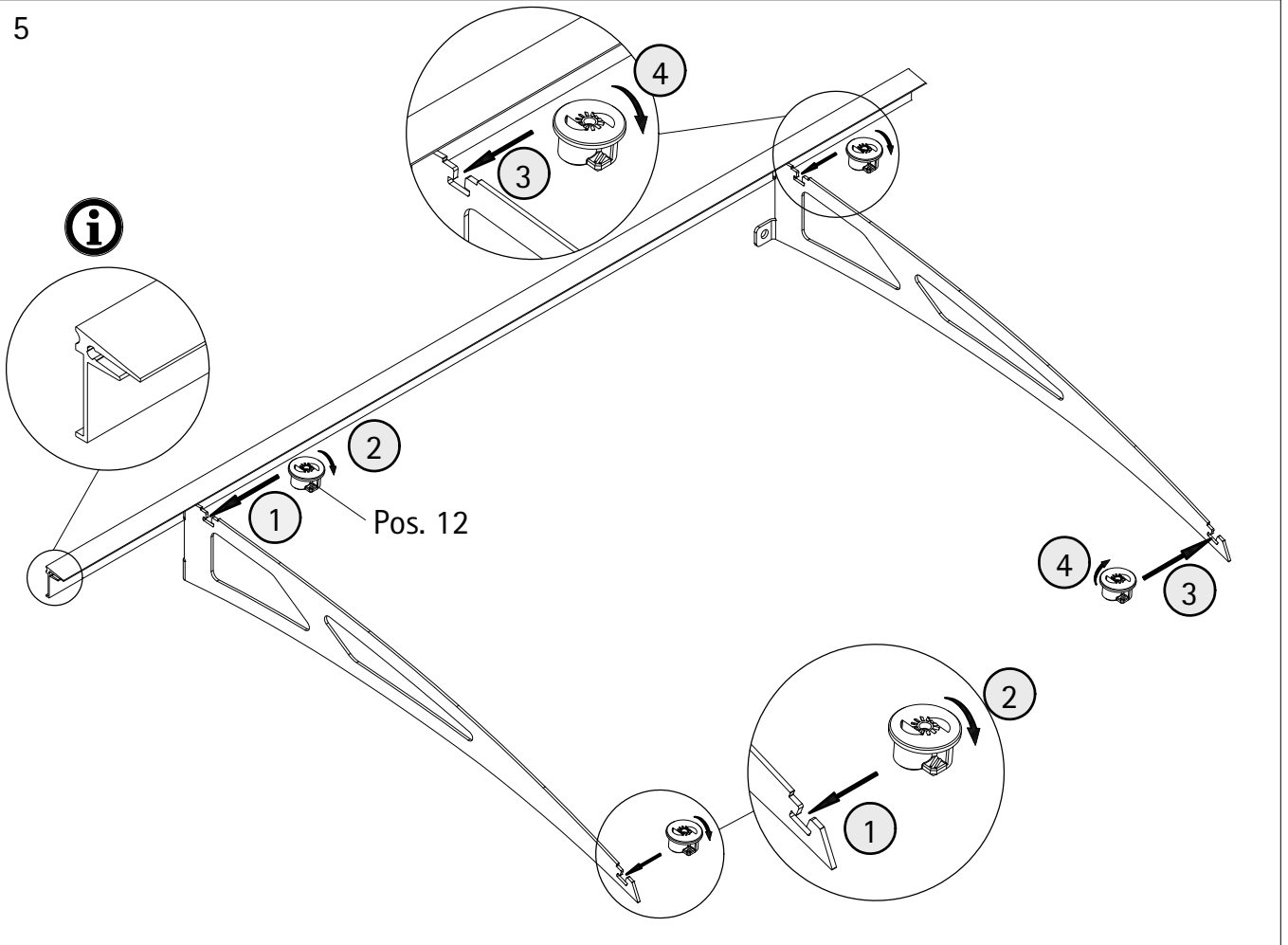

6

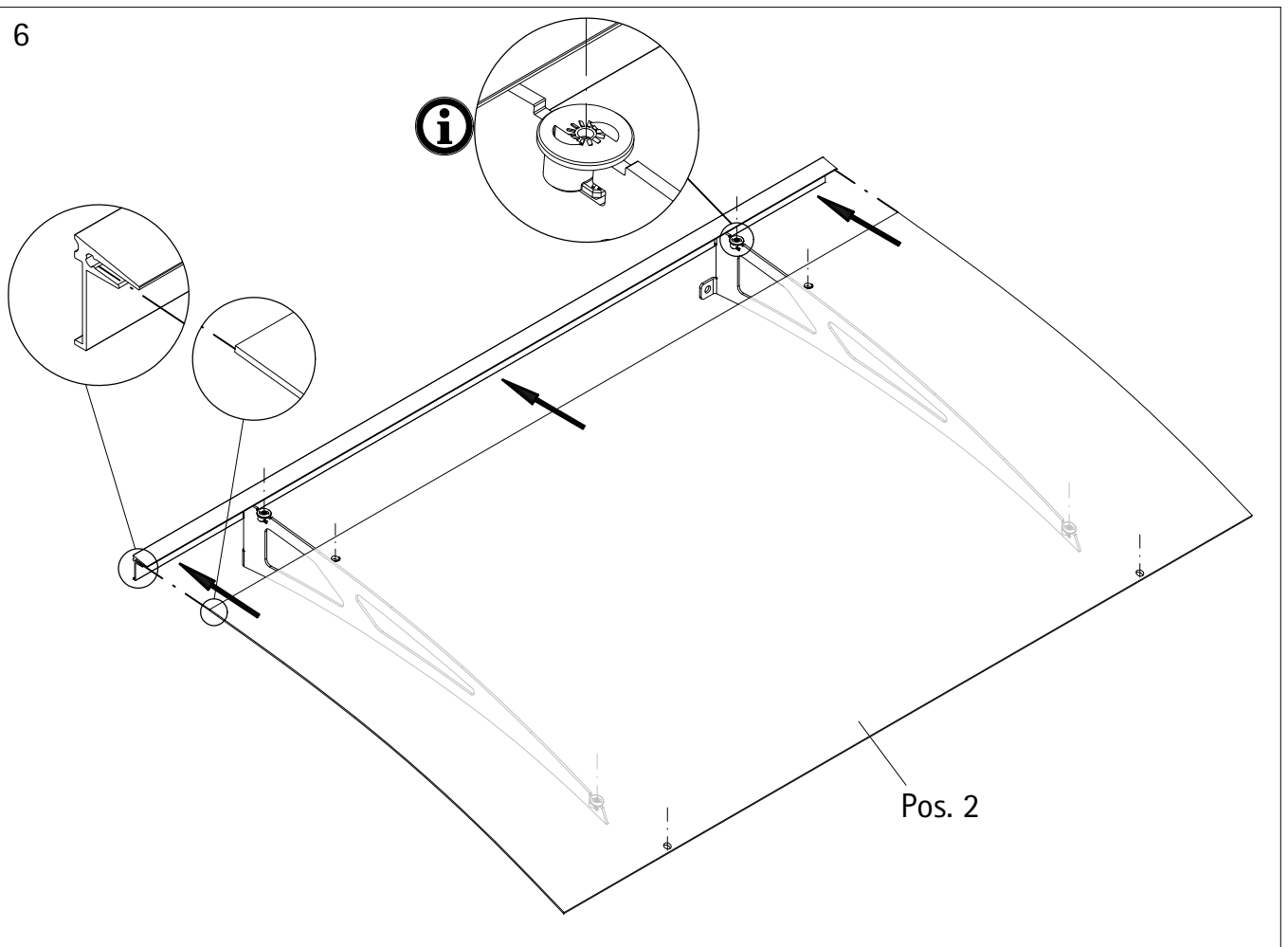

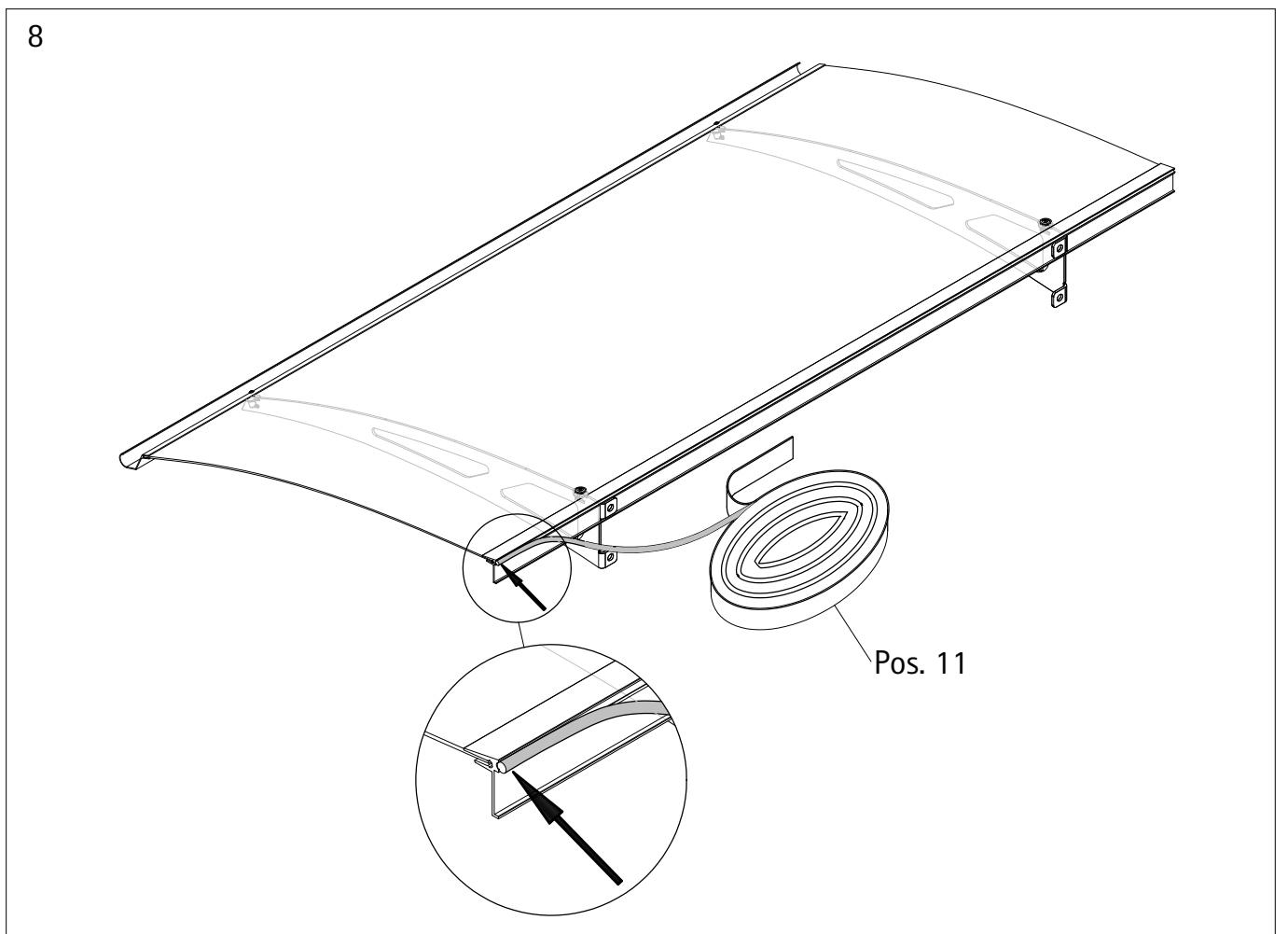
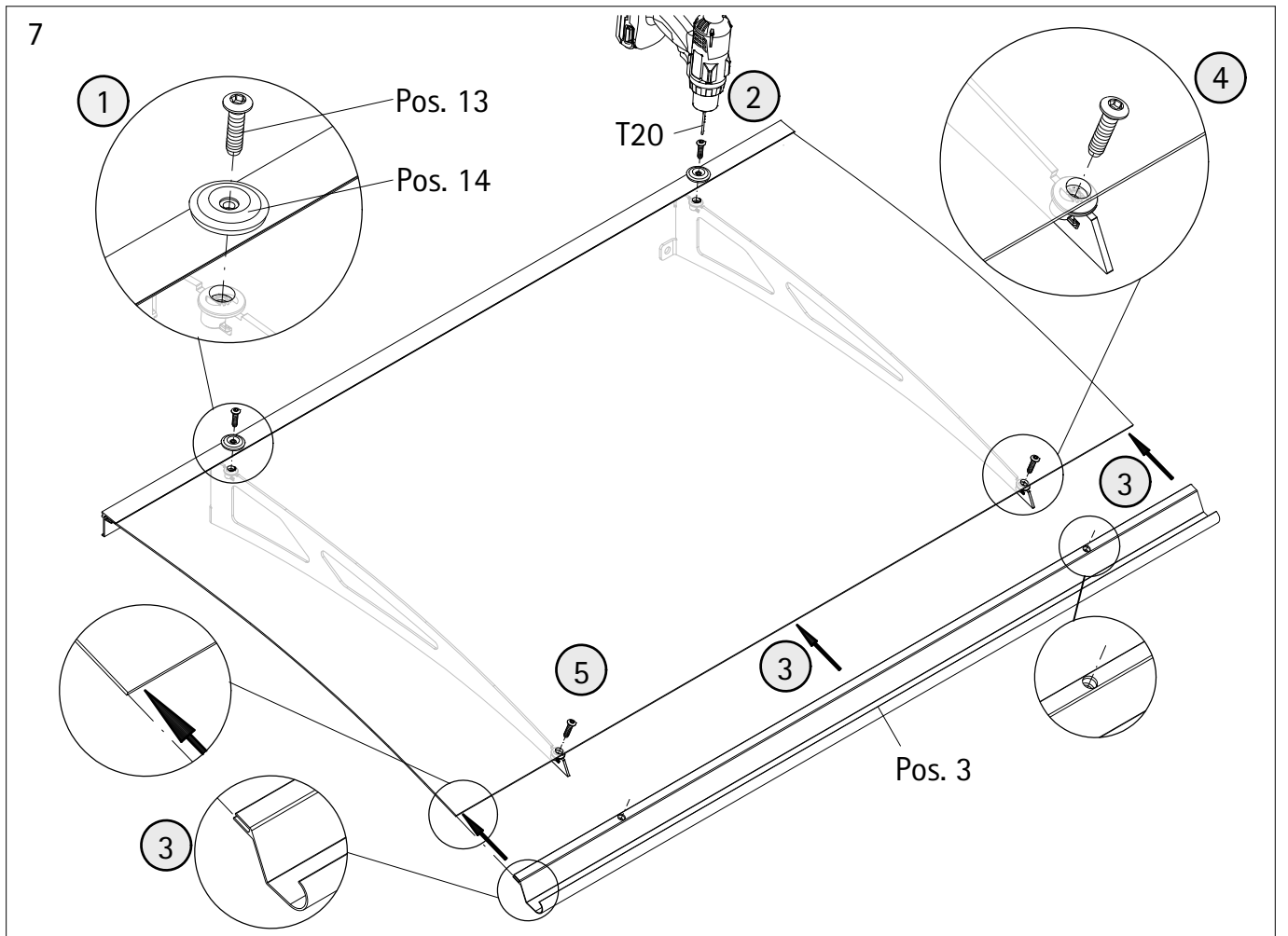

9

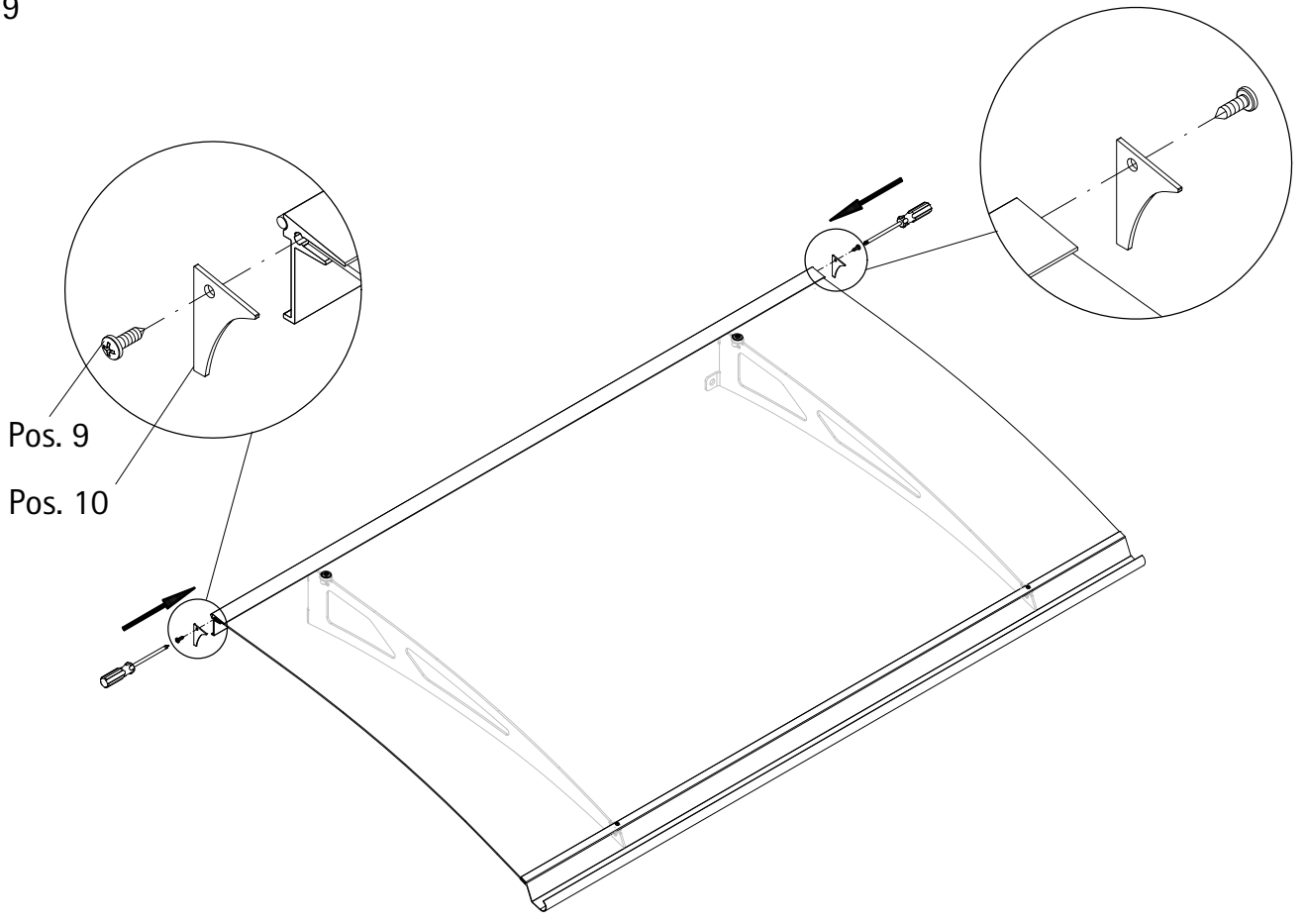

10

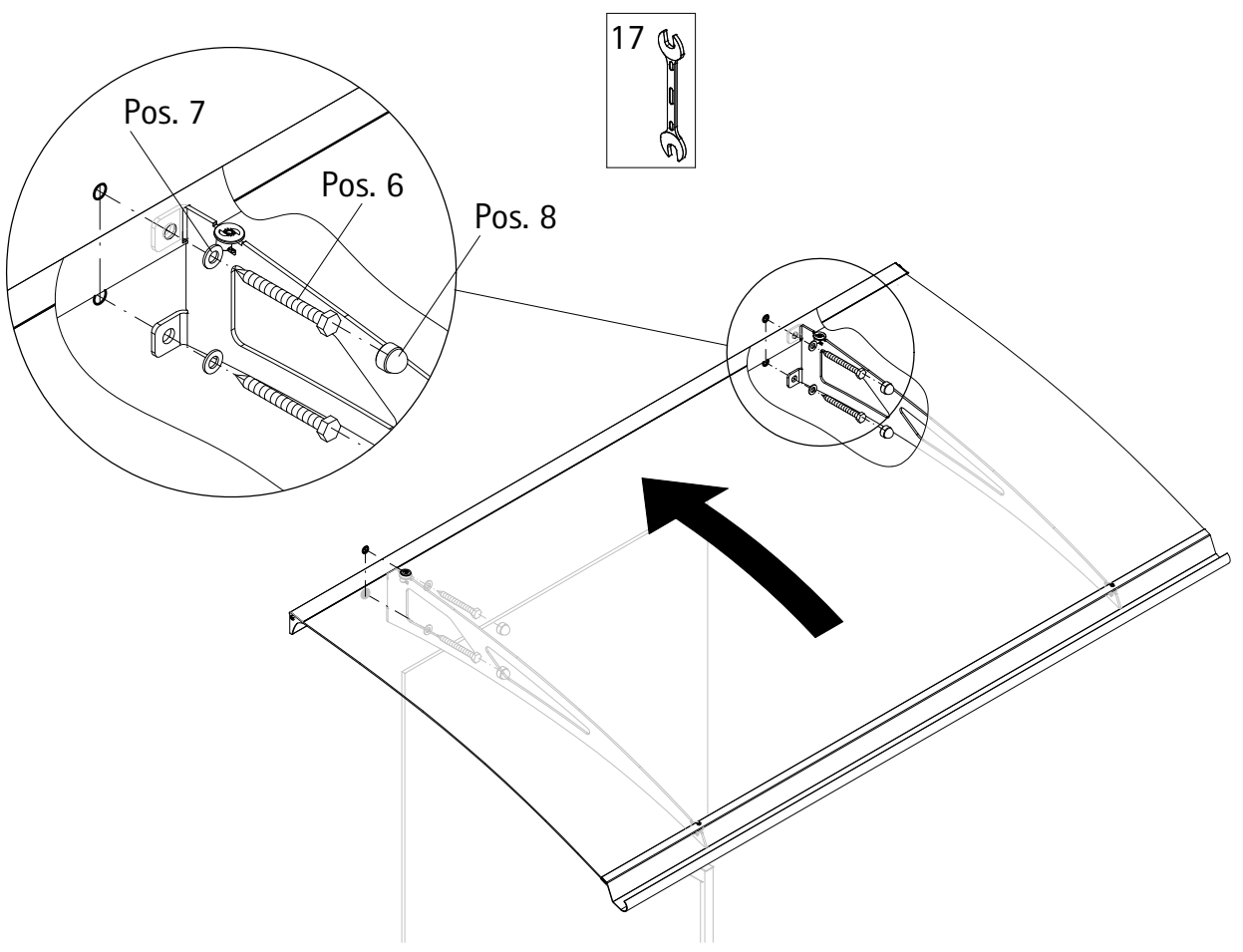

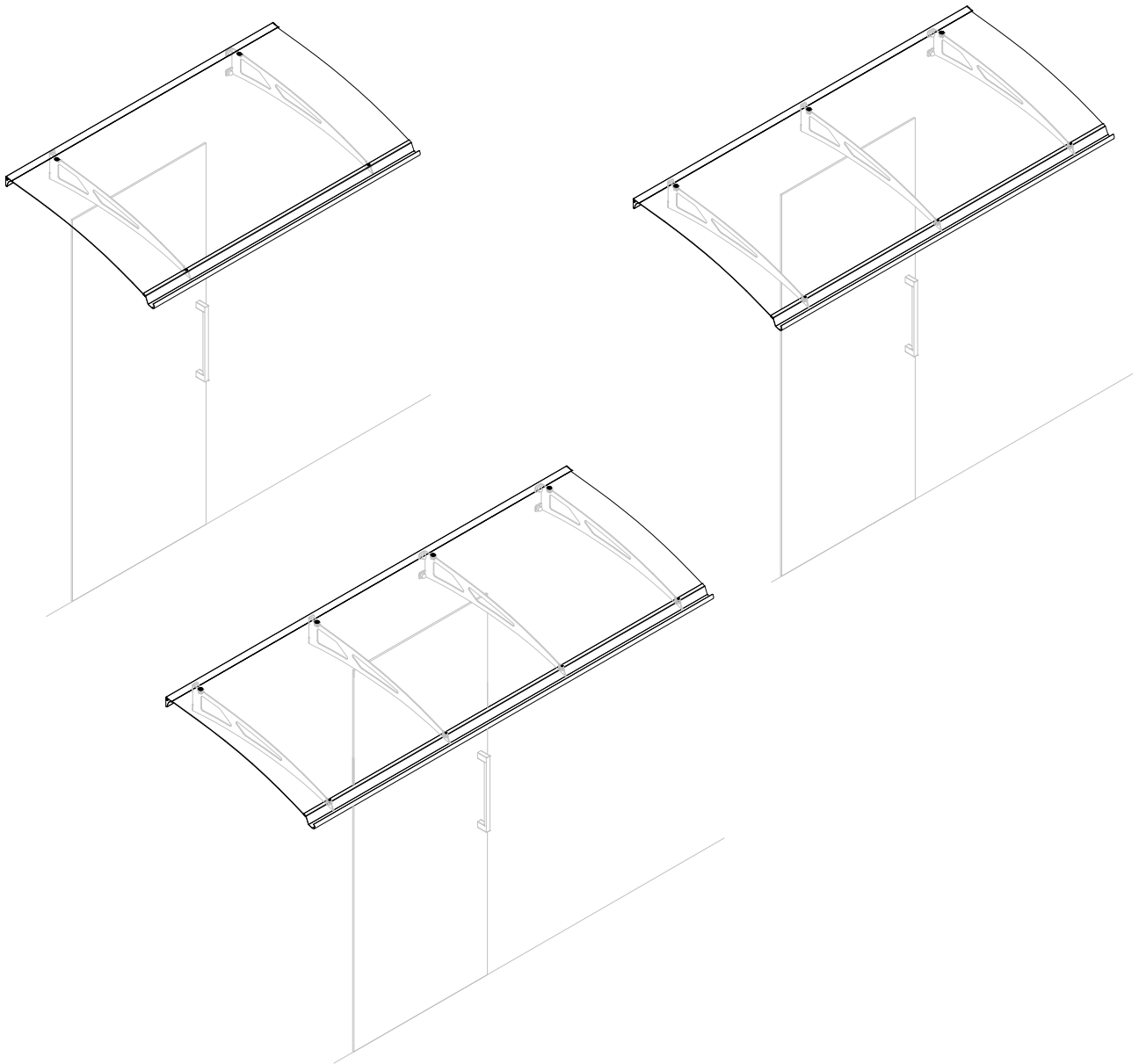

Qualitätsprüfung/ Quality check/ Contrôle de la qualité



Schulte Home GmbH & Co. KG
Am Lindhövel 1
59846 Sundern



info@schulte.de



+49 2935 9653 0



export@schulte.de



+49 2935 9653 278