



ENGLISH

# OWNER'S MANUAL

# MUSIC IN STYLE

## DOCKING SPEAKER

Please read this manual carefully before operating your set and retain it for future reference.

FOR THE WARRANTY TERMS & CONDITIONS,  
PLEASE REFER TO BACK COVER OF THIS MANUAL.

ND4520



7 45000 000000

## Safety Information



**CAUTION:** TO REDUCE THE RISK OF ELECTRIC SHOCK DO NOT REMOVE COVER (OR BACK) NO USER-SERVICEABLE PARTS INSIDE REFER SERVICING TO QUALIFIED SERVICE PERSONNEL.



This lightning flash with arrowhead symbol within an equilateral triangle is intended to alert the user to the presence of uninsulated dangerous voltage within the product's enclosure that may be of sufficient magnitude to constitute a risk of electric shock to persons.



The exclamation point within an equilateral triangle is intended to alert the user to the presence of important operating and maintenance (servicing) instructions in the literature accompanying the product.

**WARNING:** TO PREVENT FIRE OR ELECTRIC SHOCK HAZARD, DO NOT EXPOSE THIS PRODUCT TO RAIN OR MOISTURE.

**WARNING :** Do not install this equipment in a confined space such as a book case or similar unit.

**NOTICE :** For safety marking information including product identification and supply ratings, please refer to the main label on the bottom of the apparatus.

### CAUTION concerning the Power Cord

Most appliances recommend they be placed upon a dedicated circuit;

That is, a single outlet circuit which powers only that appliance and has no additional outlets or branch circuits. Check the specification page of this owner's manual to be certain. Do not overload wall outlets. Overloaded wall outlets, loose or damaged wall outlets, extension cords, frayed power cords, or damaged or cracked wire insulation are dangerous. Any of these conditions could result in electric shock or fire. Periodically examine the cord of your appliance, and if its appearance indicates damage or deterioration, unplug it, discontinue use of the appliance, and have the cord replaced with an exact replacement part by an authorized service center. Protect the power cord from physical or mechanical abuse, such as being twisted, kinked, pinched, closed in a door, or walked upon. Pay particular attention to plugs, wall outlets, and the point where the cord exits the appliance. To disconnect power from the mains, pull out the mains cord plug. When installing the product, ensure that the plug is easily accessible.

This device is equipped with a portable battery or accumulator.

**Safety way to remove the battery or the battery from the equipment:** Remove the old battery or battery pack, follow the steps in reverse order than the assembly. To prevent contamination of the environment and bring on possible threat to human and animal health, the old battery or the battery put it in the appropriate container at designated collection points. Do not dispose of batteries or battery together with other waste. It is recommended that you use local, free reimbursement systems batteries and accumulators. The battery shall not be exposed to excessive heat such as sunshine, fire or the like.

**CAUTION:** The apparatus shall not be exposed to water (dripping or splashing) and no objects filled with liquids, such as vases, shall be placed on the apparatus.

**Disposal of your old appliance**

1. When this crossed-out wheeled bin symbol is attached to a product it means the product is covered by the European Directive 2002/96/EC.
2. All electrical and electronic products should be disposed of separately from the municipal waste stream via designated collection facilities appointed by the government or the local authorities.
3. The correct disposal of your old appliance will help prevent potential negative consequences for the environment and human health.
4. For more detailed information about disposal of your old appliance, please contact your city office, waste disposal service or the shop where you purchased the product.

**Disposal of waste batteries/accumulators**

1. When this crossed-out wheeled bin symbol is attached to batteries/accumulators of Your product it means they are covered by European Directive 2006/66/EC.
2. This symbol may be combined with chemical symbols for mercury(Hg), cadmium(Cd) or lead(Pb) if the battery Contains more that 0.0005% of mercury,0.002% of cadmium or 0.004% of lead.
3. All batteries/accumulators should be disposed separately from the municipal waste stream via designated collection facilities appointed by the government or the local authorities.
4. The correct disposal of Your old batteries/accumulators will help to prevent potential negative consequences for the environment, animal and human health.
5. For more detailed information about disposal of Your old batteries/accumulators, please contact Your city office, waste disposal service or the shop where You purchased the product.

**For Wireless product European Union Notice**

LG Electronics hereby declares that this/ these product(s) is/are in compliance with the essential requirements and other relevant provisions of Directive 1999/5/EC, 2004/108/EC, 2006/95/EC and 2009/125/EC.

Please contact to the following address for obtaining a copy of the DoC (Declaration of Conformity).

**European Standards Centre:**

Krijgsman 1, 1186 DM Amstelveen, The Netherlands

- Please note that this is NOT a Customer Service contact point. For Customer Service Information, see Warranty Card or contact the dealer that you purchased this product.

Indoor use only.

**RF Radiation Exposure Statement**

This equipment should be installed and operated with minimum distance 20cm between the radiator and your body.

## 4 Getting Started

**POWER:** This unit operates on a mains supply of 200-240V~, 50/60Hz.

**Wiring:** This unit is supplied with a BS 1363 approved main plug. When replacing the fuse, always use of the same rating approved to BS 1362. Never use this plug with the fuse cover omitted. To obtain a replacement fuse cover contact your dealer. If the type of plug supplied is not suitable for the mains sockets in your home, then the plug should be removed and a suitable type fitted. Please refer to the wiring instructions below:

**Warning:** A mains plug removed from the mains lead of this unit must be destroyed. A mains plug with bared wires is hazardous if inserted in a mains socket. Do not connect either wire to the earth pin, marked with the letter E or with the earth symbol  $\perp$  or coloured green or green and yellow. If any other plug is fitted, use same rating of fuse in the plug.

**Important:** The wires in this mains lead are coloured in accordance with the following codes:

**- BLUE: NEUTRAL, BROWN: LIVE** - As the colours of the wires in the mains lead of this unit may not correspond with the coloured marking identifying the terminals in your plug, proceed as follows: The wire which is coloured blue must be connected to the terminal which is marked with the letter N or coloured black. The wire which is coloured brown must be connected to the terminal which is marked with the letter L or coloured red.

# Table of Contents

## 1 Getting Started

---

- 2 Safety Information
- 6 Unique Features
  - 6 – Made for iPod/iPhone/iPad
  - 6 – Portable In
  - 6 – USB playback
- 6 Accessories
- 6 Introduction
  - 6 – Symbol Used in this Manual
- 7 Playable file Requirement
  - 7 – MP3/ WMA music file requirement
  - 7 – Compatible USB Devices
  - 7 – USB device requirement
- 8 Remote Control
  - 8 – Battery Installation
- 9 Front Panel
- 9 Back Panel
- 10 Top Panel
- 11 Connecting the AC adapter
- 11 Battery Installation

## 2 Operating

---

- 12 Overall Operation
- 13 Basic Operations
  - 13 – iPod/iPhone/iPad Operations
  - 14 – USB Operation
  - 15 – Turn off the sound temporarily
  - 15 – Resume playback
- 16 Advanced Operation
  - 16 – Listening to music from your external device
- 17 Using a Bluetooth wireless technology
  - 17 – Listening to music stored on the Bluetooth devices
  - 19 – Using Bluetooth Apps.

## 3 Troubleshooting

---

- 21 Troubleshooting

## 4 Appendix

---

- 22 Trademarks and Licenses
- 23 Specifications
- 24 Handling the Unit

## 5 Warranty

---

- 25 Warranty

## Unique Features

### Made for iPod/iPhone/iPad

Enjoys music from iPod/iPhone/iPad with simple connection.

### Portable In

Listens to music from your portable device.

### USB playback

Enjoys music from USB with simple connection.

## Accessories

Please check and identify the supplied accessories.

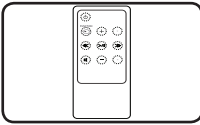

Remote control (1)

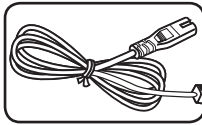

Power cord(1)

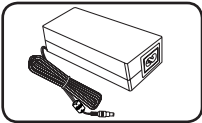

AC adapter(1)

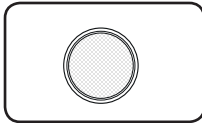

Battery (1)

## Introduction

### Symbol Used in this Manual

#### ! Note

Indicates special notes and operating features.

#### ⚠ Caution

Indicates cautions for preventing possible damages from abuse.

## LG Bluetooth Remote

You can control this player with your iPhone or Android phone via Bluetooth. This player and your phone must be connected to Bluetooth. Visit "Apple App Store" or "Google Android Market (Google Play Store)". And use this QR code to search for "LG Bluetooth Remote" app. For detailed information, refer to the 19 page.



(Android OS)



(Apple iOS)

# Playable file Requirement

## MP3/ WMA music file requirement

MP3/ WMA file compatibility with this unit is limited as follows :

- Sampling frequency : within 32 to 48 kHz (MP3), within 32 to 48 kHz (WMA)
- Bit rate : within 32 to 320 kbps (MP3), 40 to 192 kbps (WMA)
- Maximum files : Under 999
- File extensions : ".mp3"/ ".wma"

## Compatible USB Devices

- MP3 Player : Flash type MP3 player.
- USB Flash Drive : Devices that support USB1.1.
- The USB function of this unit does not support all USB devices.

## USB device requirement

- Devices which require additional program installation when you have connected it to a computer, are not supported.
- Do not extract the USB device while in operation.
- For a large capacity USB, it may take longer than a few minutes to be searched.
- To prevent data loss, back up all data.
- If you use a USB extension cable or USB hub, the USB device is not recognized.
- Using NTFS file system is not supported. (Only FAT(16/ 32) file system is supported.)
- This unit is not supported when the total number of files is 1 000 or more.
- External HDD, Card readers, Locked devices, or hard type USB devices, mobile phone are not supported.
- USB port of the unit cannot be connected to PC. The unit cannot be used as a storage device.
- Some USB may not work with this unit.
- In power on state, you can't charge a iPad via USB port.
- In power on state, you can charge a iPod/ iPhone/smart phone via USB port.
- When you connect smart phone to USB port, you can only charge it in power on state. (Some smart phone may not be charged)

## Remote Control

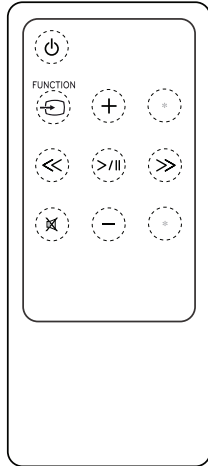

(POWER) : Switches the unit ON or OFF.

**FUNCTION** : Selects the function and input source.

(VOL) : Adjusts speaker volume.

(Skip/Search) :

- Skips Fast backward or Forward.
- Searches for a section within a file.

(Play/Pause) : Starts or pauses playback.

: Mutes the sound.

: This button is not available.

### Caution

The battery used in this device may present a fire or chemical burn hazard if mistreated. Do not recharge, disassemble, incinerate, or heat above 100 °C (212 °F). Replace the battery part no. CR2025 only. Use of another battery may present a risk of fire or explosion. Dispose of the used battery. Keep the battery away from children. Do not disassemble the battery or dispose of it in fire.

## Battery Installation

You have two ways to open the battery compartment.

1. Turn the battery compartment counterclockwise by using a coin or your finger. Then take the battery compartment out.

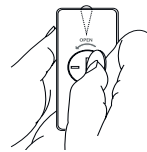

Coin

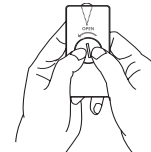

Finger

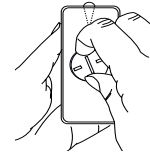

2. Insert and fix the battery with the plus(+) facing in the same direction as the plus(+) on the battery compartment.

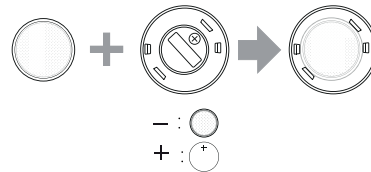

3. Put the battery compartment on the remote control and turn it clockwise to close.

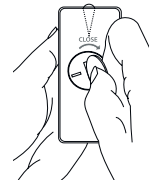

Coin

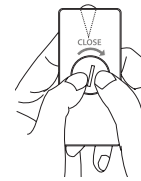

Finger

### Caution

If you have long nail, do not open the battery compartment by using your finger. Or else, your nail would be broken.



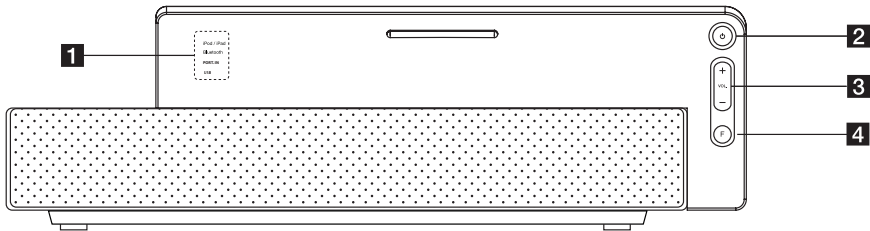

## Front Panel

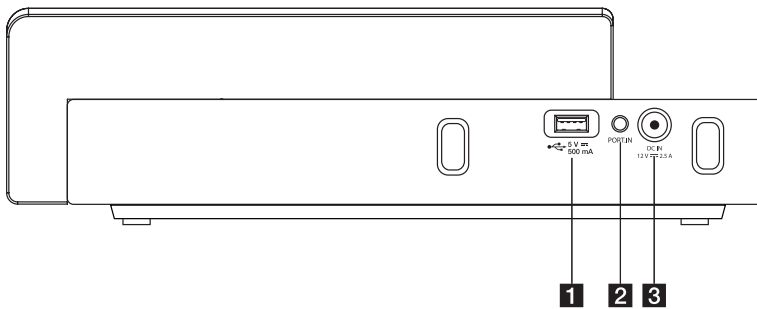

- 1** Indicator
- 2**  (POWER)  
Switches the unit ON or OFF.
- 3** **VOL (+/-)**  
Adjusts speaker volume.
- 4** **F (FUNCTION)**  
Selects the function and input source.  
(iPod/iPad, Bluetooth, PORT.IN, USB)

## Back Panel



- 1** USB Port  
Plays music file by connecting the USB device.
- 2** **PORT. IN (3.5mm)**  
Listens to music from your portable device.
- 3** DC IN12V  2.5A (AC adapter input)

## Top Panel

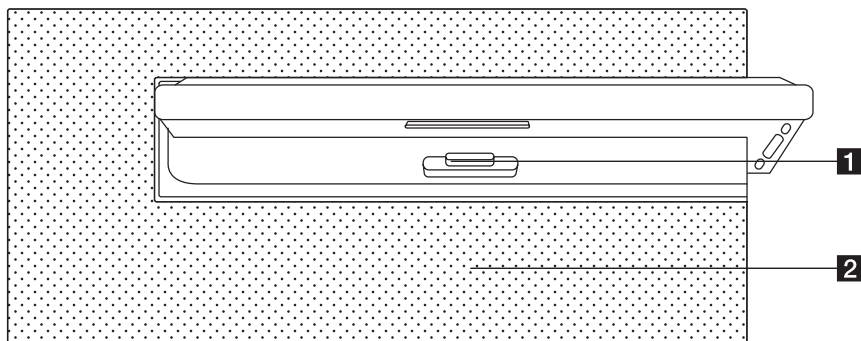

- 1** iPod/iPhone/iPad Dock  
Connects an iPod/iPhone/iPad.
- 2** Speaker

## Connecting the AC adapter

1. Connect the supplied AC power cord to the AC adapter.
2. Connect the AC adapter cable to DC IN adapter input.
3. Plug the AC power cord into an AC outlet.

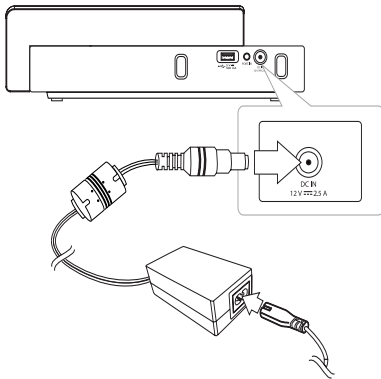

### ! Caution

Only use the AC adapter supplied with this device. Do not use a power supply from another device or manufacturer. Using any other power cable or power supply may cause damage to the device and void your warranty.

## Battery Installation

1. Press and open the battery cover.
2. Put six "AA size batteries" (not supplied) into the compartment making sure the  $\oplus$  and  $\ominus$  should be correctly positioned.
3. Close the battery cover.

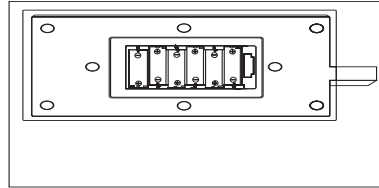

### ! Caution









- Keep the batteries out of the unit when you do not use them for a long time.
- Replace the batteries with new ones when they need changing.
- Alkaline or NiMH battery is recommended to use.

### ! Note

- Charging via this unit is only available when the unit's power cord is inserted in the outlet.

## Overall Operation

You can operate the unit by using these button. To get more information, refer to the table below.

Mode Button	IPOD / IPAD	PORT.IN	USB	BLUETOOTH
- / +	VOL -/+	VOL -/+	VOL -/+	VOL -/+
	Power on/off	Power on/off	Power on/off	Power on/off
press  	Skip -/+	-	Skip -/+	-
press and hold  	Back scan Forward scan	-	Back scan Forward scan	-
 / 	Play/Pause	-	Play/Pause	-
 <b>FUNCTION</b> <b>F</b>	Changes each of function	Changes each of function	Changes each of function	Changes each of function
	Mute/Unmute the sound	Mute/Unmute the sound	Mute/Unmute the sound	Mute/Unmute the sound

# Basic Operations

## iPod/iPhone/iPad Operations

You can enjoy the sound with your iPod/iPhone/iPad. For details about iPod/iPhone/iPad, refer to the iPod/iPhone/iPad User Guide.

1. Connect the iPod/iPhone/iPad firmly. If you turn this unit on, your iPod/iPhone/iPad is automatically turned on and starts recharging .

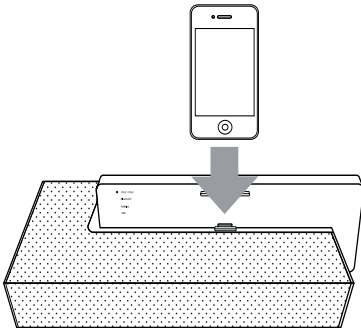

2. Press **FUNCTION** or **F** to select iPod/iPad function.

To	Do this
Pauses or restart	Press <b>&gt;  </b>
Skip	During playback, press <b>&lt;&lt;/&gt;&gt;</b> to go to the next file or to return to the beginning of the current file. During playback, Press <b>&lt;&lt;&lt;</b> twice briefly to step back to the previous file.
Search	Press and hold <b>&lt;&lt;/&gt;&gt;</b> during playback and release it at the point you want to listen to.

## Compatible iPod/iPhone/iPad

The unit supports the models as follows.

- iPod touch
- iPod nano
- iPhone 4 S
- iPhone 4
- iPhone 3GS
- iPhone 3 G
- iPad 2
- iPad

Depending on your iPod/iPhone/iPad's software version, you may not control your iPod/iPhone/iPad from the unit.

Depending on your iPod/iPhone/iPad device, you may not control your iPod/iPhone/iPad from the unit.

**Note**

- Depending on your iPod/iPhone/iPad's software version, it may not be possible to control your iPod/iPhone/iPad from this unit. We recommend installing the latest software version.
- If you use an application, make a call, or send and receive SMS text message, etc. on iPod touch, iPhone or iPad disconnect it from iPod/iPhone/iPad dock of this unit and then use it.
- If you have a problem with your iPod/iPhone/iPad, please visit [www.apple.com/support](http://www.apple.com/support).
- In power on/off state, you can charge your iPod/iPhone/iPad by connecting it to iPod/iPhone/iPad Dock.
- You may need additional operation for iPod touch or iPhone, for example "unlock" by dragging the slider.
- Your iPod/iPhone/iPad is not charged when the power cord of the unit is off, though your batteries are in the unit.

**USB Operation**

1. Connect the USB device to the USB port.
2. Select the USB function by pressing **FUNCTION** or **F**.

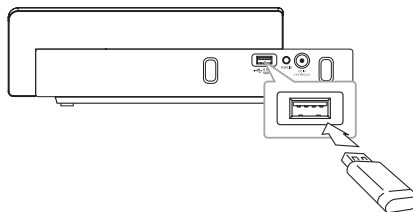
**Note**

Removing the USB Device from the unit

1. Choose a different function/mode.
2. Remove the USB device from the unit.

To	Do this
Play	Press <b>&gt;  </b>
Pause	During playback, press <b>&gt;  </b>
Skipping to the next/previous file	During playback, press <b>&lt;&lt; / &gt;&gt;</b> to go to the next file or to return to the beginning of the current file. During playback, press <b>&lt;&lt;</b> twice briefly to step back to the previous file.
Searching for a section within a file	Press and hold <b>&lt;&lt; / &gt;&gt;</b> during playback and release it at the point you want to listen to.

**Note**

- During playback, if you turn the unit off and on, the last file you listened to plays normally.
- During playback, if you change the function mode, and return back to the previous function mode, the last file you listened to play normally.
- USB Folders/Files are recognized as below

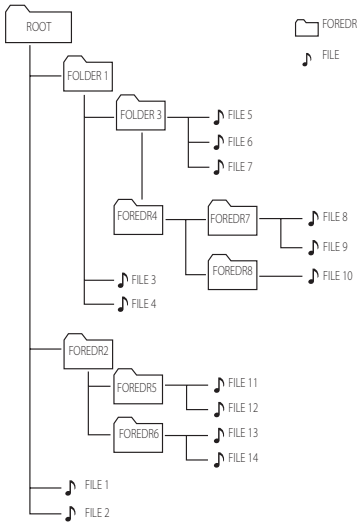

- File will be played from 🎵 file No.1 to 🎵 file No.14 one by one.
- \*ROOT : The first screen you can see when a computer recognize the USB is called "ROOT"

**Turn off the sound temporarily**

Press on the remote control to mute your unit.

You can mute the sound in order, for example, to answer the telephone. To cancel mute function, press again or VOL up and down.

**Resume playback**



The unit memorizes the point where you pressed the . Press to resume playback.

## Advanced Operation

### Listening to music from your external device

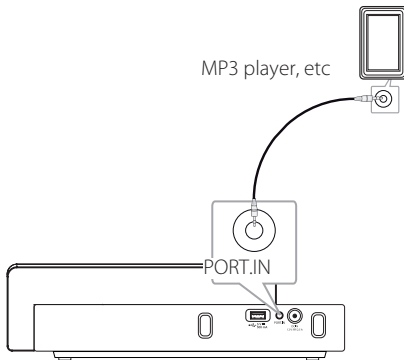
The unit can be used to play the music from many types of external device. (Portable cable is not supplied as an accessory with this unit.)



1. Connect the external device to the **PORT.IN** connector of the unit.
2. Turn the power on by pressing .
3. Select the PORT. IN function by pressing  **FUNCTION** or **F**.
4. Turn the external device on and start playing it.



## Using a Bluetooth wireless technology

### About Bluetooth

Bluetooth® is wireless communication technology for short range connection.

The available range is within 10 meters.

(The sound may be interrupted when the connection interfered by the other electronic wave or you connect the bluetooth in the other rooms.) Connecting individual devices under Bluetooth® wireless technology does not incur any charges. A mobile phone with Bluetooth® wireless technology can be operated via the Cascade if the connection was made via Bluetooth® wireless technology. Available Devices : Mobile phone, MP3, Laptop, PDA.

### Bluetooth Profiles

In order to use Bluetooth wireless technology, devices must be able to interpret certain profiles. This unit is compatible with following profile.

A2DP (Advanced Audio Distribution Profile)

## Listening to music stored on the Bluetooth devices

Before you start the pairing procedure, make sure the Bluetooth feature is turned on in to your Bluetooth device. Refer to your Bluetooth device's user guide. Once a pairing operation is performed, it does not need to be performed again.

1. Select the Bluetooth function by using the  **FUNCTION** or **F**. Then Bluetooth LED of this unit will light up and blink.
2. Operate the Bluetooth device and perform the pairing operation. When searching for this unit with the Bluetooth device, a list of the devices found may appear in the Bluetooth device display depending on the type of Bluetooth device. Your unit appears as "LG AUDIO ND4520".
3. Enter the PIN code.  
PIN code : 0000
4. When this unit successfully is connected with your Bluetooth device, Bluetooth LED of this unit lights up without blinking.

#### Note

Depending on the Bluetooth device type, some device have a different pairing way.

5. Listen to music.  
To play a music stored on your Bluetooth device, refer to your Bluetooth device's user guide.

#### Note

- Sound from the main set can be distorted if you raise the volume of the device up to two-thirds or more
- When you use the bluetooth function, adjust the volume of a bluetooth device to a proper level to listen to.

- After searching for this unit on your Bluetooth device, pair the Bluetooth device with this unit. Then play the file you want.
- The sound may be interrupted when the connection is interfered by the other electronic wave.
- You cannot control the Bluetooth device with this unit.
- Pairing is limited one Bluetooth device per one unit and multi-pairing is not supported.
- Although the distance between your Bluetooth and the set is less than 10m, there are obstacles between both, your Bluetooth device cannot be connected.
- Depending on the type of the device, you may not be able to use the Bluetooth function.
- You can enjoy wireless system using phone, MP3, Notebook, etc..
- The Electrical malfunction due to devices using same frequency such as Medical equipment, Microwaves or wireless LAN devices, the connection will be disconnected.
- When someone stands and interrupts communication between Bluetooth device and the player, the connection will be disconnected.
- If the gotten away of the distance between Bluetooth and the unit, the sound quality is lower and the connection will be disconnected when the space between the Bluetooth and the unit gets out of the operating range of Bluetooth.
- The device with Bluetooth wireless technology is disconnected, if you turn off the unit or put the device away from the unit more than 10m.
- If the Bluetooth device is disconnected, you should connect the Bluetooth device to your unit.

## Using Bluetooth Apps.

### About LG Bluetooth Remote App

LG Bluetooth Remote App bring a suit of new features to your unit.  
To enjoy more features, you are recommended to download and install free "LG Bluetooth Remote".

### Install " LG Bluetooth app" onto your Bluetooth device

1. Install " LG Bluetooth app" by using QR code.  
Use the scanning software to scan the QR code.
2. Tap an icon for installation.
3. Tap an icon for downloading.

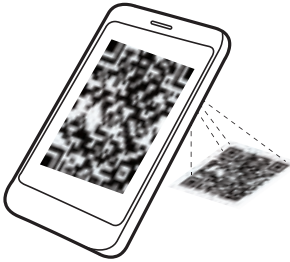

(Android OS)



(Apple iOS)

#### ! Note

- Make sure that your powered Bluetooth device is connected to the Internet.
- Make sure that your Bluetooth device has a scanning software application. If you don't have one, download one from "Apple App Store" or "Google Android Market (Google Play Store)".

### Install " LG Bluetooth Remote app " by docking your iPhone/iPad/iPod onto your player.

1. Connect your iPhone/iPad /iPod to iPod/iPhone/iPad Dock. The display for downloading "LG Bluetooth Remote" will be linked automatically. (iOS O/S only)
2. Tap an icon for installation.
3. Tap an icon for downloading.

### Install " LG Bluetooth Remote app" through " Apple App Store" or "Google Android Market"

1. Tap the Apple App Store icon or Google Android Market(Google Play Store)icon.
2. In the search bar, type in the "LG Bluetooth Remote"and search it.
3. In the search result list, find and tap"LG Bluetooth Remote" to start downloading Bluetooth app.
4. Tap an icon for installation.
5. Tap an icon for downloading.

#### ! Note

- Make sure that your powered Bluetooth device is connected to the Internet.
- Make sure that your powered Bluetooth device is equipped with " Apple App Store" or "Google Android Market(Google Play Store)".

## Activate Bluetooth with LG Bluetooth Remote app

LG Bluetooth app helps to connect your powered bluetooth device to the unit.

1. Tap LG Bluetooth app icon on the screen to open LG Bluetooth app application, and go to the main menu.
2. Tap [Setting] and select the unit you want.
3. If you want to get more information to operate, tap [Setting] and [Help].

### ! Note

- After connecting Bluetooth device to the unit by using iOS BT app, connect iPod/iPhone/iPad to the unit. Then the function will be switched to IPOD/IPAD function automatically. If you disconnect the iPod/iPhone/iPad from the unit, the Bluetooth device will be connected to your player automatically.
- While using Bluetooth, you may not operate BT App. Disconnect Bluetooth device you have connected before to use BT App properly.
- If you use Bluetooth App for operation, there would be some differences between Bluetooth App and the supplied remote control. Use the supplied remote control as necessary.
- If you operate BT app with Bluetooth device connected, the Bluetooth connection you have connected before may be disconnected. (Depending on the smartphone's O/S, this process has a difference.)
- Depending on the Bluetooth device, BT.App may not work.
- In Bluetooth function, if you use BT app, the supplied remote control may not work.
- When using BT app for remote control, the operation may differ from the supplied remote control.
- According to the smartphone's operating system, you have some differences for BT app's operation.

### ! Note

- When your Bluetooth device have been already connected with other unit, disconnect the Bluetooth connection first. Then you can control your player through BT app.
- The connection you've made may be disconnected if you select other application or change the setting of the connected device via BT app. In such case, please check the connection status.
- If you place your iPod/iPhone/iPad into the dock of this unit while your iPod/iPhone/iPad is connected to this unit by Bluetooth connection, the Bluetooth connection is deactivated.
- The Bluetooth connection of iPod/iPhone/iPad is not activated while iPod/iPhone/iPad is placed into the dock of this unit.

# Troubleshooting

Problem	Correction
No Power.	<ul style="list-style-type: none"> <li>• Plug in the power cord.</li> <li>• Check the condition by operating other electronic devices.</li> <li>• Replace exhausted batteries with new ones.</li> </ul>
No sound.	<ul style="list-style-type: none"> <li>• Press  <b>FUNCTION</b> or <b>F</b> and check the selected function.</li> </ul>
The remote control does not work properly.	<ul style="list-style-type: none"> <li>• Operate the remote control within about 23 ft (7 m).</li> <li>• Remove the obstacle in the path of the remote control and the unit..</li> <li>• Replace the battery with new one.</li> </ul>
iPod/iPhone/iPad does not work.	<ul style="list-style-type: none"> <li>• Connect it to the unit correctly.</li> </ul>

## Trademarks and Licenses



“Made for iPod,” “Made for iPhone,” and “Made for iPad” mean that an electronic accessory has been designed to connect specifically to iPod, iPhone, or iPad, respectively, and has been certified by the developer to meet Apple performance standards. Apple is not responsible for the operation of this device or its compliance with safety and regulatory standards. Please note that the use of this accessory with iPod, iPhone, or iPad may affect wireless performance.

4

Appendix





Bluetooth® wireless technology is a system which allows radio contact between electronic devices within a max. range of 10 meters.

Connecting individual devices under Bluetooth® wireless technology does not incur any charges. A mobile phone with Bluetooth® wireless technology can be operated via the Cascade if the connection was made via Bluetooth® wireless technology.

The Bluetooth® word mark and logos are owned by the Bluetooth® SIG, Inc. and any use of such marks by LG Electronics is under license.

Other trademarks and trade names are those of their respective owners.

## Specifications

General	
AC adapter requirements	DC 12 V  2.5 A, 100 - 240V, 50/60 Hz
Power consumption	30 W
Dimensions (W x H x D)	320(348) X 60(90) X 150 mm
Net Weight (Approx.)	1.54 Kg
Operating temperature	5 °C to 35 °C (41 °F to 95 °F)
Operating humidity	5 % to 90 %
Bus Power Supply	DC 5 V  500 mA,
iPod/iPhone/iPad	DC 5 V  2.1 A

Inputs	
PORT. IN	0.5 Vrms (3.5 mm stereo jack)

Amplifier	
Output Power	5 W + 5 W (8Ω at 1kHz)
T.H.D	10 %

Speakers	
Type	built-in
Impedance Rated	8 Ω
Rated Input Power	5 W
Max. Input Power	10 W

- Design and specifications are subject to change without notice.

## Handling the Unit

### When shipping the unit

Please save the original shipping carton and packing materials. If you need to ship the unit, for maximum protection, re-pack the unit as it was originally packed at the factory.

### Keeping the exterior surfaces clean

Do not use volatile liquids such as insecticide spray near the unit.

Wiping with strong pressure may damage the surface.

Do not leave rubber or plastic products in contact with the unit for a long period of time.

### Cleaning the unit

To clean the player, use a soft, dry cloth. If the surfaces are extremely dirty, use a soft cloth lightly moistened with a mild detergent solution. Do not use strong solvents such as alcohol, benzine, or thinner, as these might damage the surface of the unit.





### Technology with the human touch GUARANTEE

- LG Electronics U.K. Ltd. will provide the following services in order to expedite this Guarantee.
- 1. All faulty components which fail due to defective manufacture will be replaced free of charge for a period of 12 months from the original date of purchase.
- 2. The dealer (or his service agent) who sold the product will be reimbursed for any labour provided in the repair of this LG equipment, for a period of 12 months from the original date of purchase. These claims must be made in accordance with the published scale of service charges and relevant claims procedure.

#### PLEASE NOTE:

- A. The dealer may restrict the guarantee to the original purchaser.
- B. The dealer is not obliged to carry out service under guarantee if unauthorized modifications are made to the apparatus, or if non standard components are used or if the serial number of the apparatus is removed, defaced, misused, or altered.
- C. Any claims made under guarantee must be directed to the dealer from whom the equipment was originally purchased. The dealer may, before carrying out service under guarantee, require a receipted account as evidence of the date of purchase.
- D. We respectfully point out that your dealer is not obligated to replace batteries if they become exhausted or worn in use.
- E. Aerial alignment and consumer control adjustments are not covered by this guarantee.

This guarantee does not affect your statutory rights.

- REQUIREMENTS TO MAINTAIN WARRANTY COVERAGE:  
RETAIN YOUR RECEIPT TO PROVE DATE OF PURCHASE. A COPY OF YOUR RECEIPT MUST BE SURRENDERED AT THE TIME GUARANTEE SERVICE IS PROVIDED.
- Product Registration Card :  
It is helpful to complete at least your name, address, phone, model & serial numbers and return it. This will enable LG to assist you in the future should you lose your receipt, your units be stolen, or should modifications be necessary.
- To obtain information or assistance: Call 0870 873 5454 Monday-Friday 9.00am-4.30pm

MODEL NO.*	SERIAL NO.*	DATE OF PURCHASE.*

**In all cases of difficulty - consult your LG dealer from whom the product was purchased**

LGEUK Website : [www.lge.co.uk](http://www.lge.co.uk)  
( service website : [www.lgelectronics.co.uk](http://www.lgelectronics.co.uk) )

