

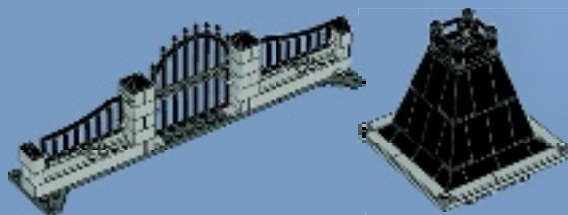

MONSTER FIGHTERS

10228

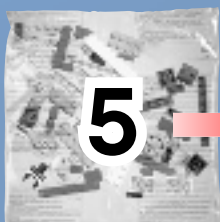

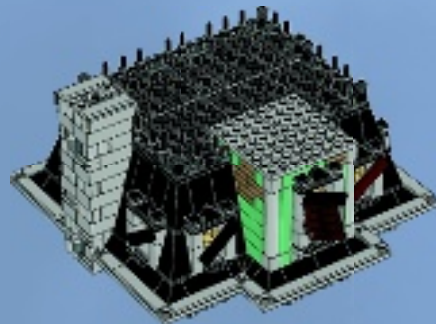
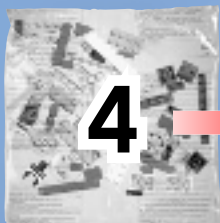
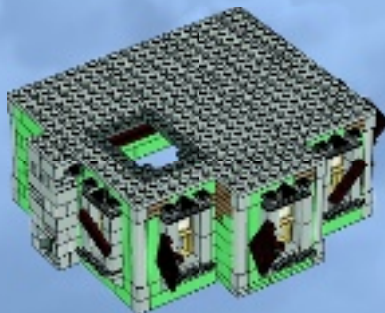
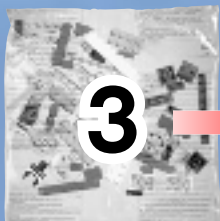
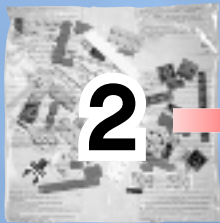
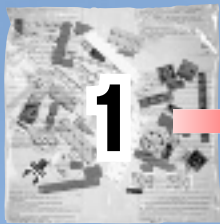

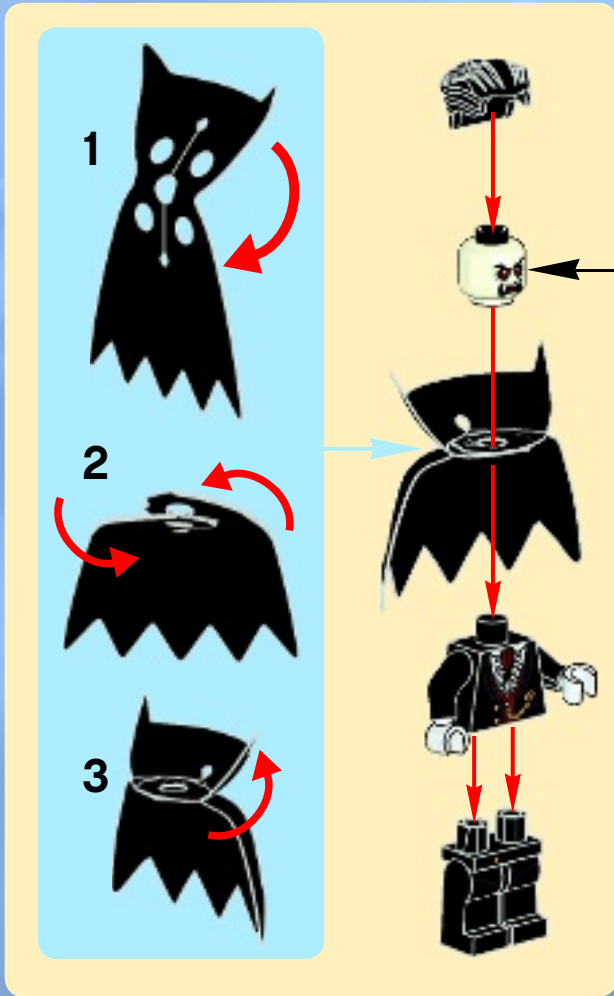

<http://lego.com/brickseparator>

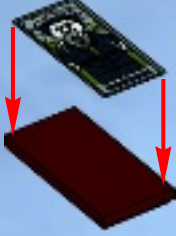
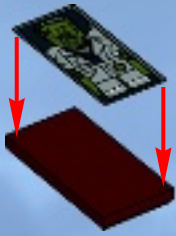
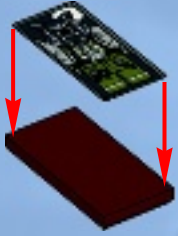
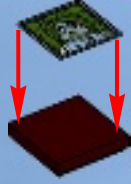
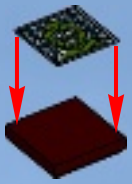

2

1



2



3

1



2



2x



1



4

1



2



4x  2x  1x  1x 

5

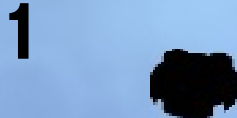

1x  4x  1x  1x 

6





7

1



2



3



4



8

1

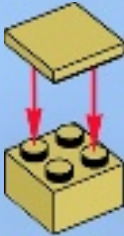

2

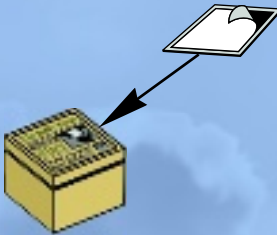

3

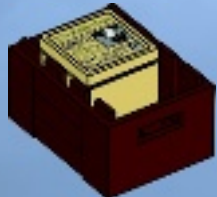

4

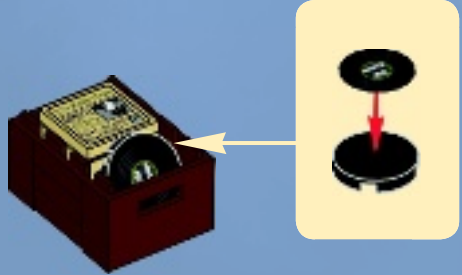



9



10

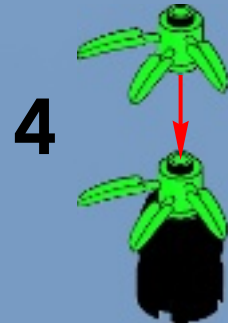
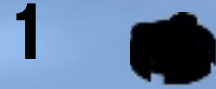



1x



1x

11

1

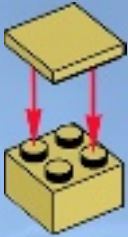

2

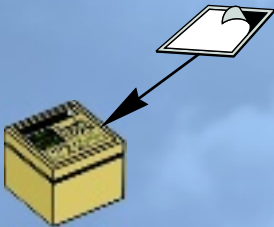

1x



1x



1x

12

1



2



2x

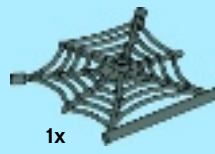

1x

13

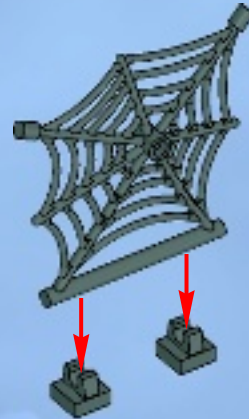

1x



1x



1x

14

1

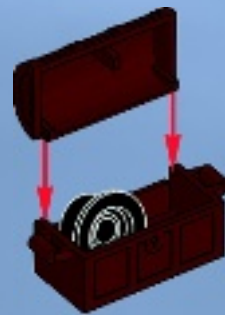

2



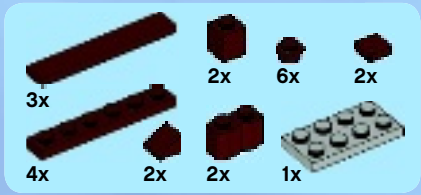

15

1



2

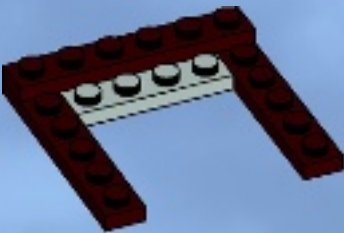

3



4

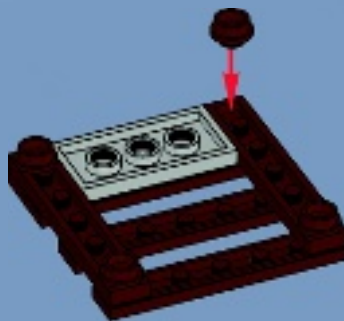

5

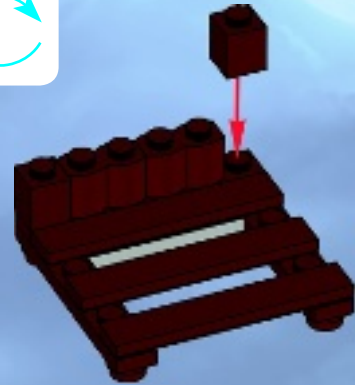

6



7



8



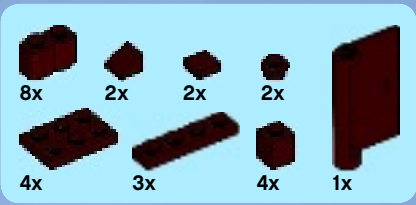

16

1



2

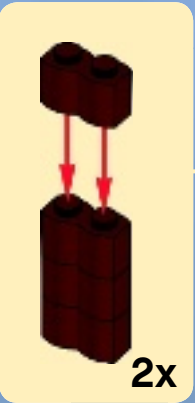

3

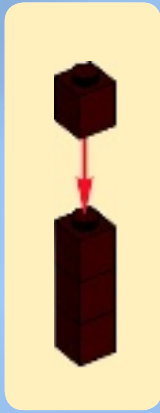
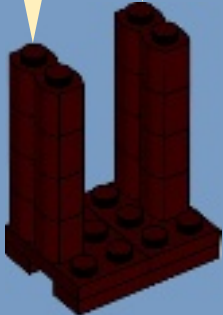

4

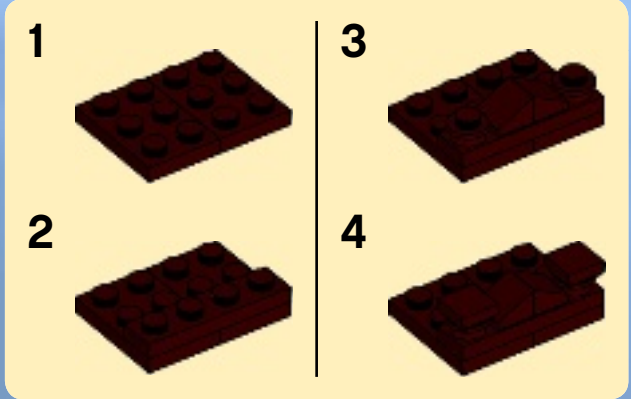
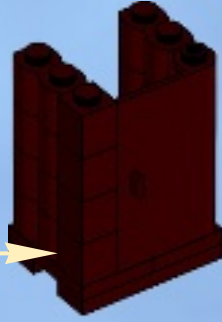

5

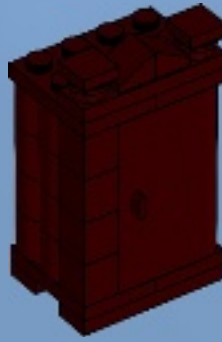



1x



1x



2x



2x



1x



1x



1x



3x



2x



2x



1x



1x

17

1

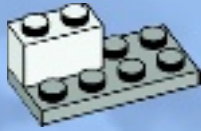

2

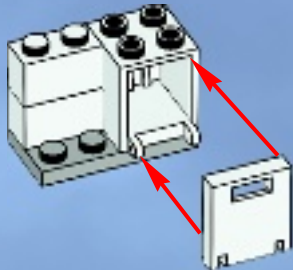

3



4



5



6



7



8



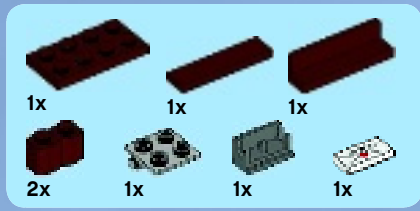

18

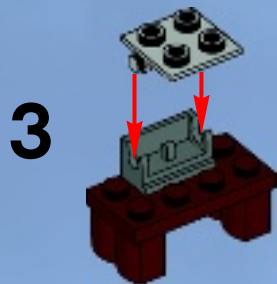

19



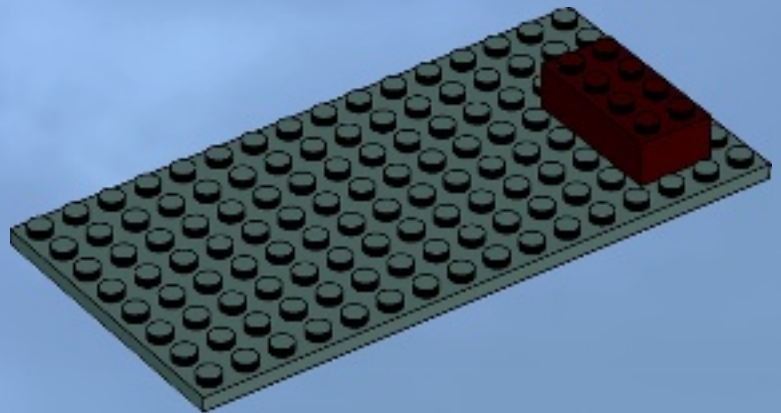
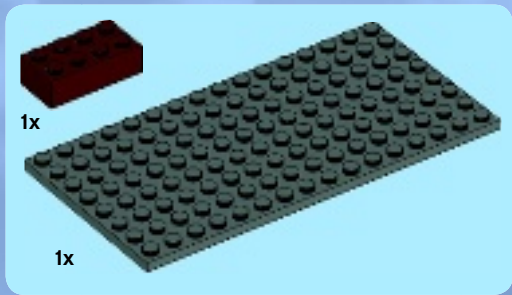
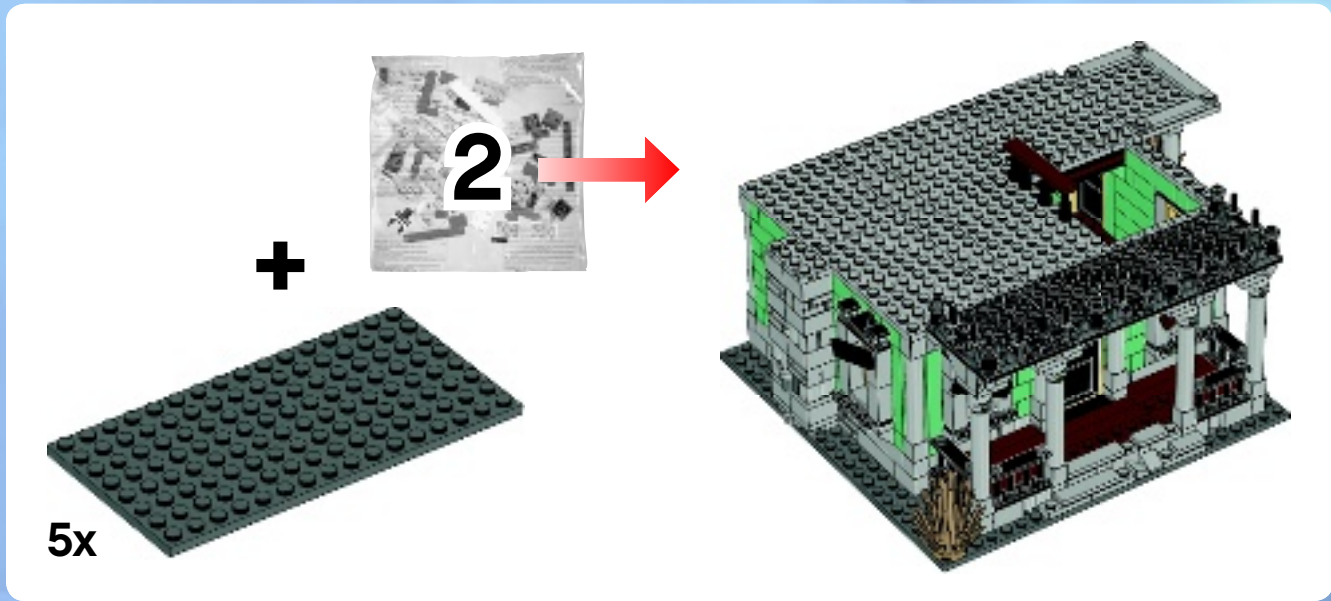

1

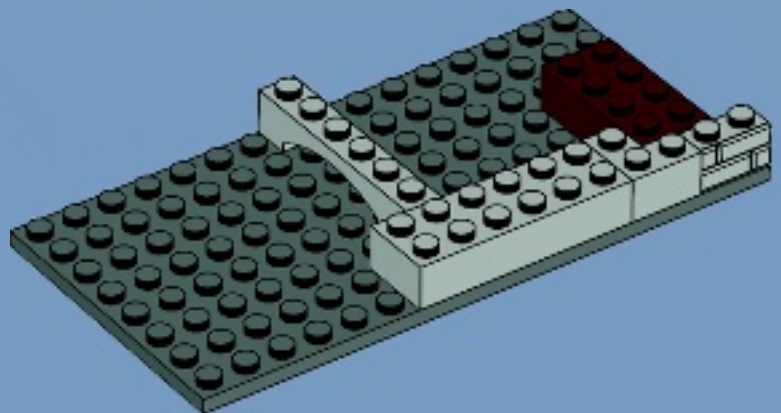
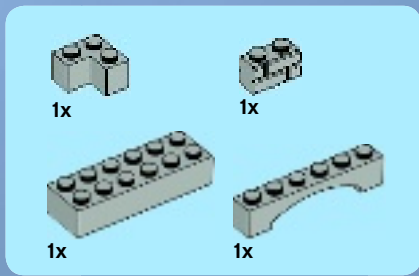

2

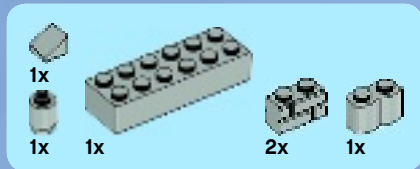

3

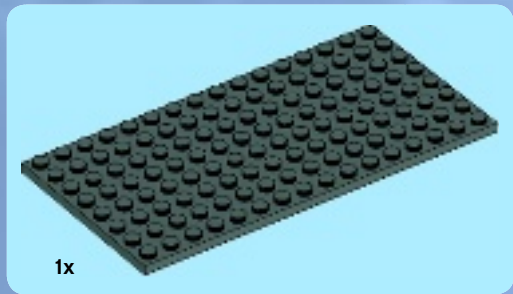
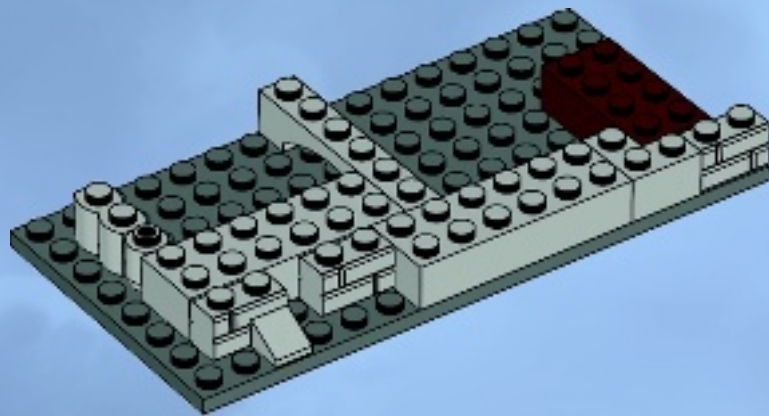

4

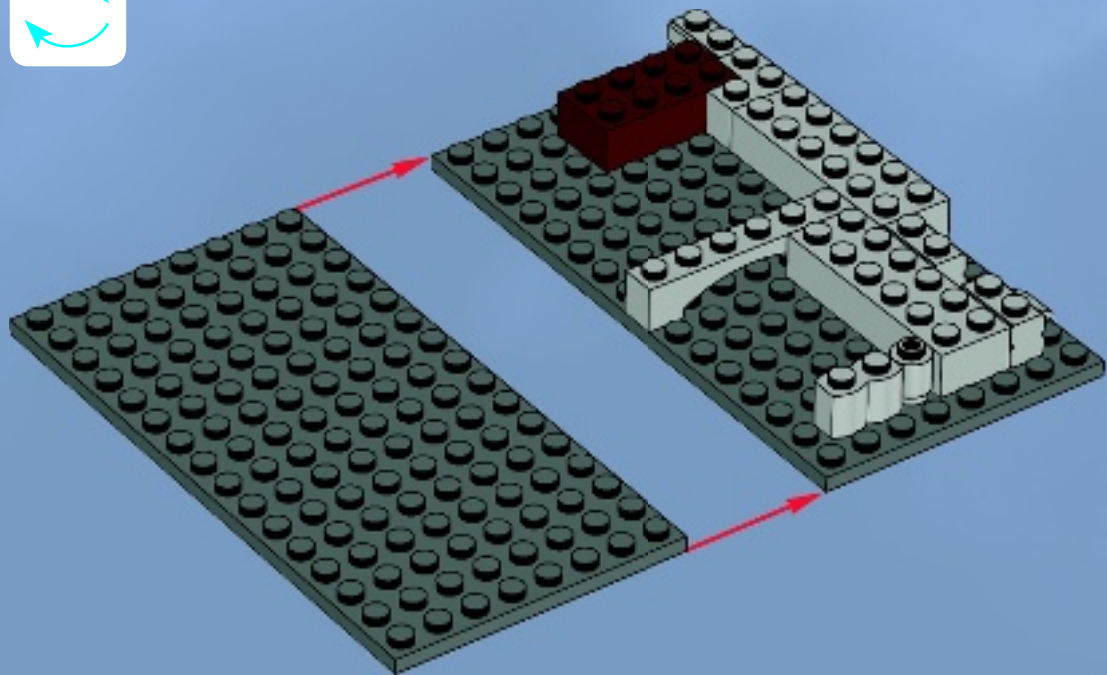

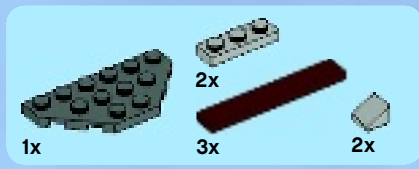

5

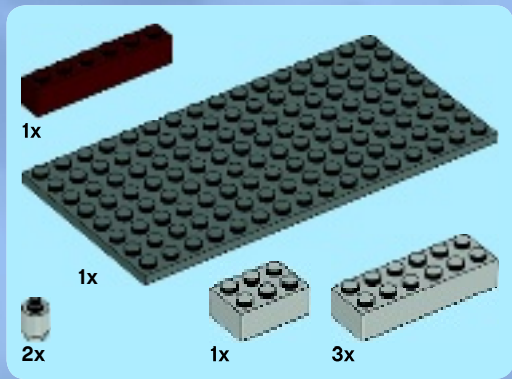
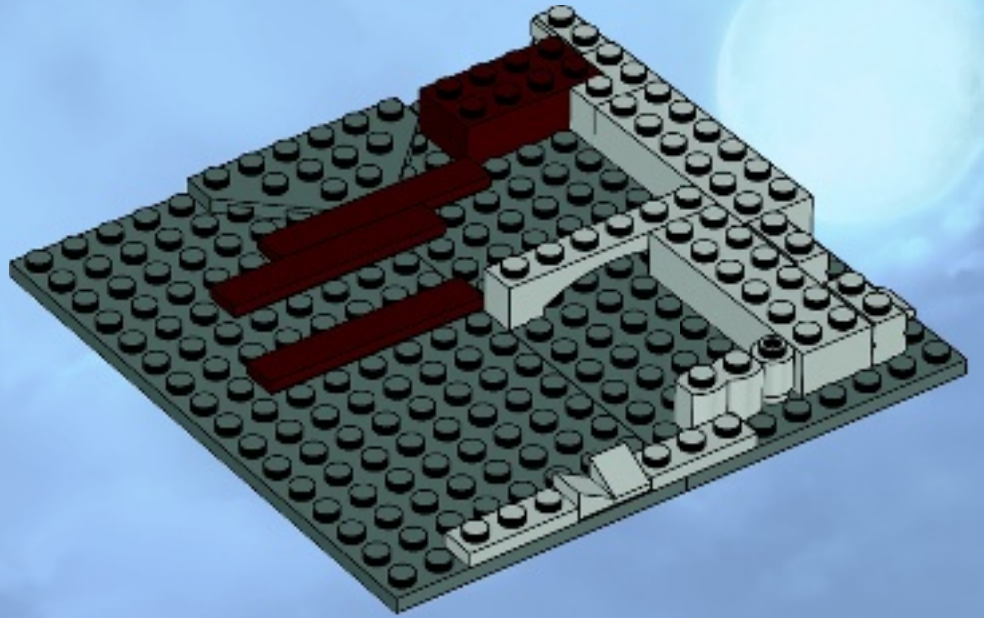

6

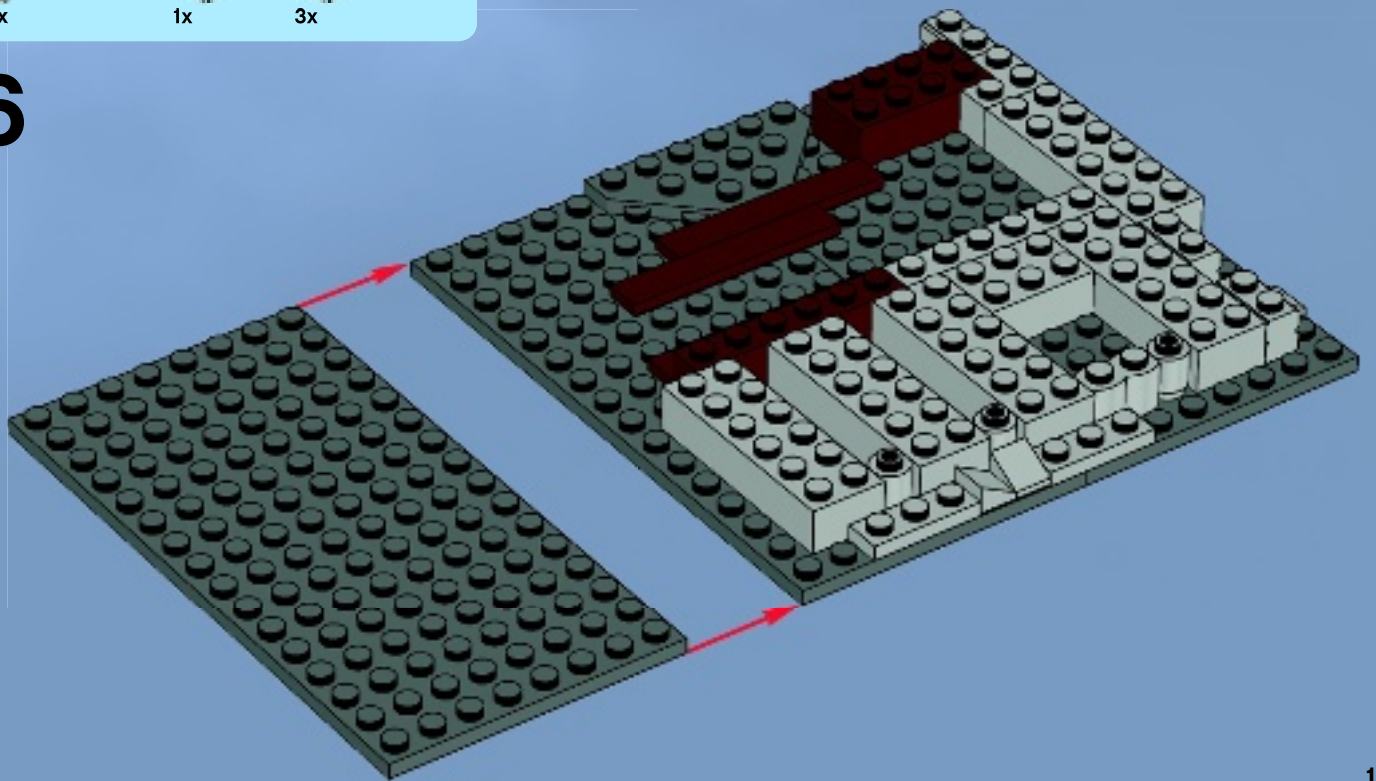

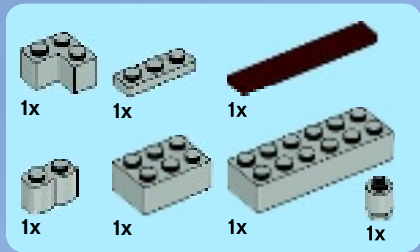

7

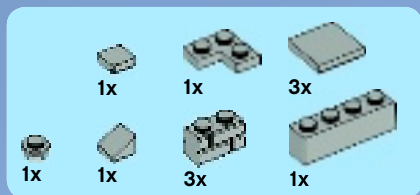
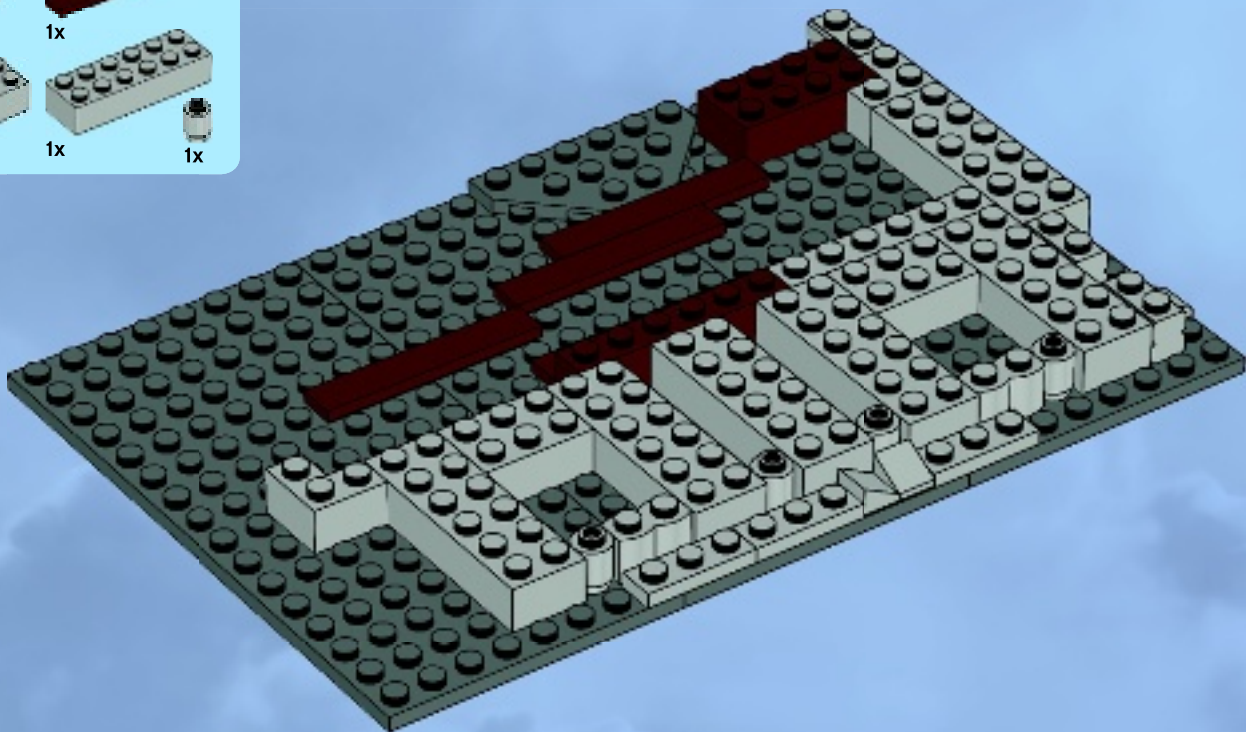

8

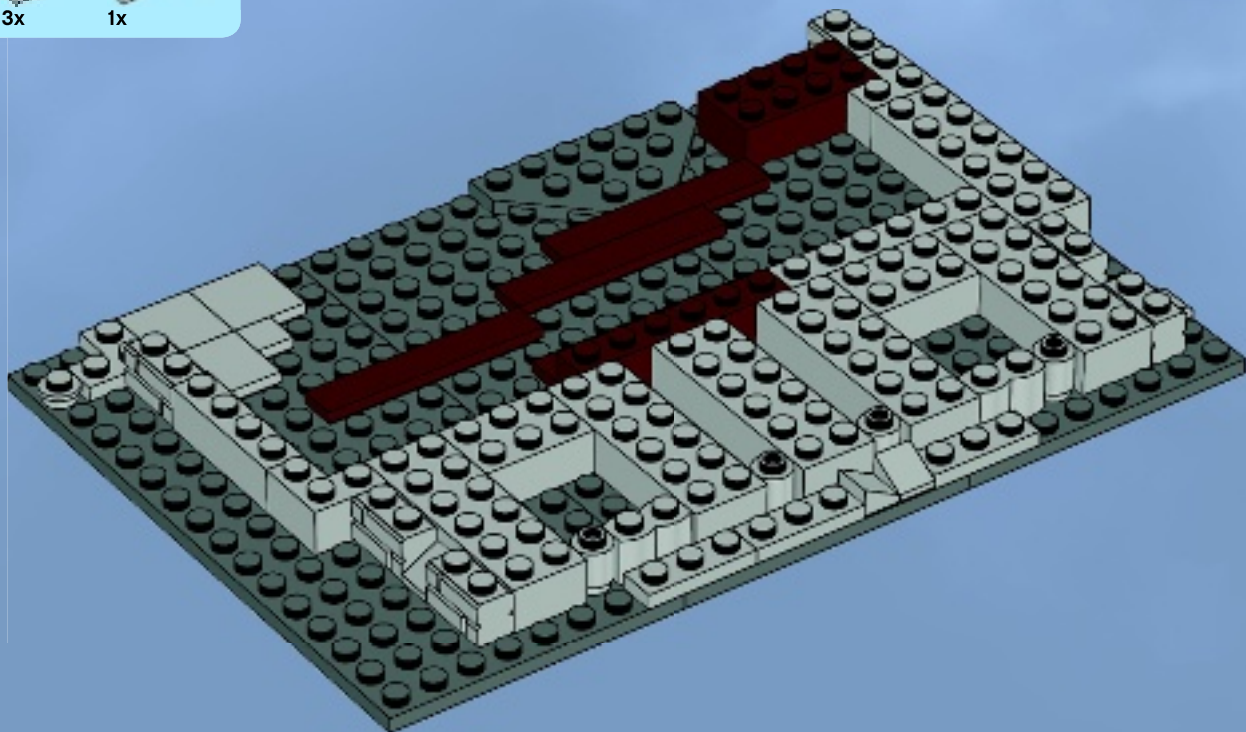

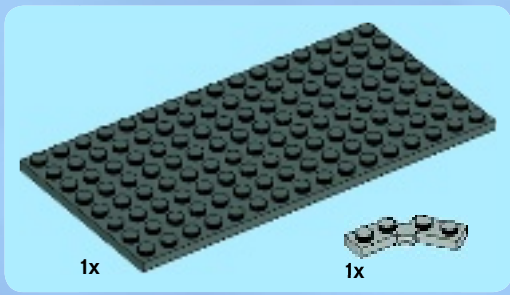

9

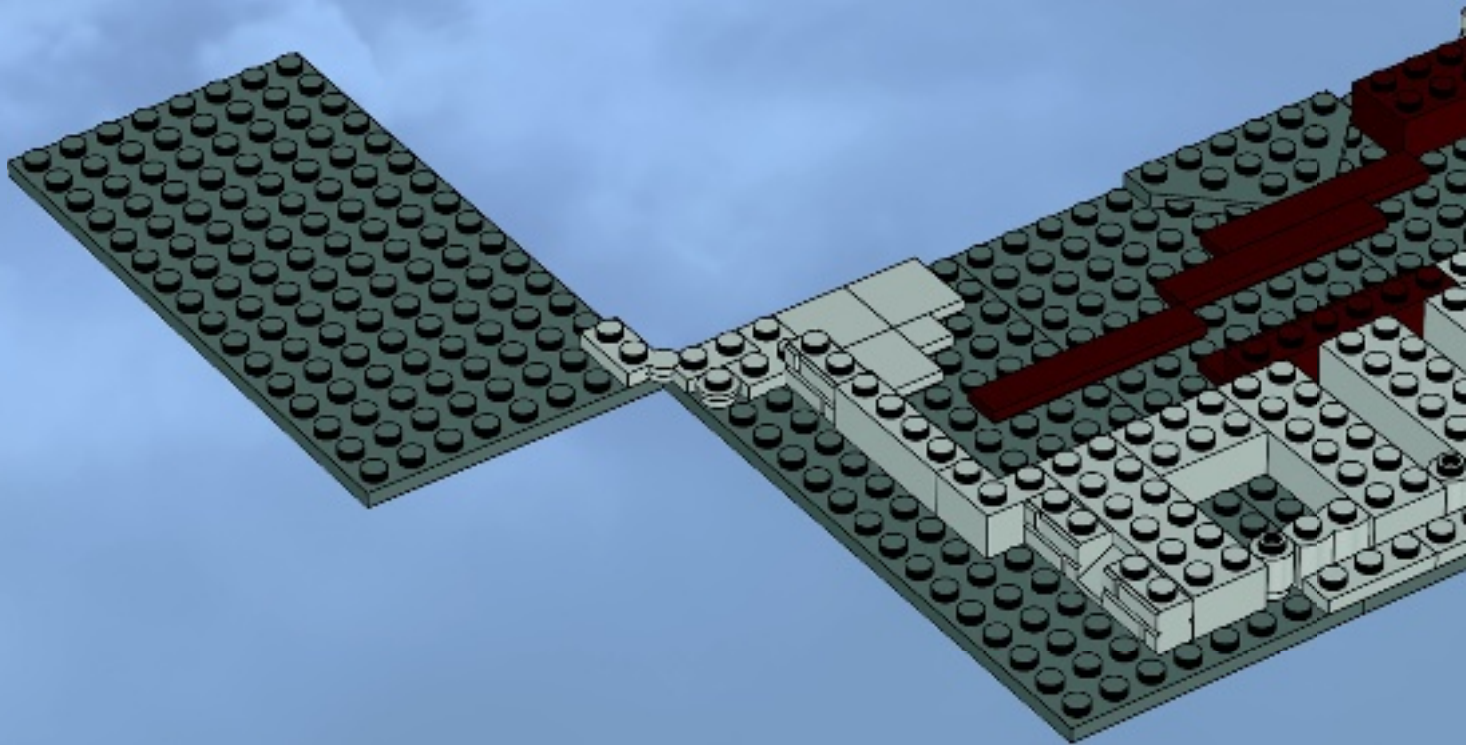



1x



1x



1x



3x

10

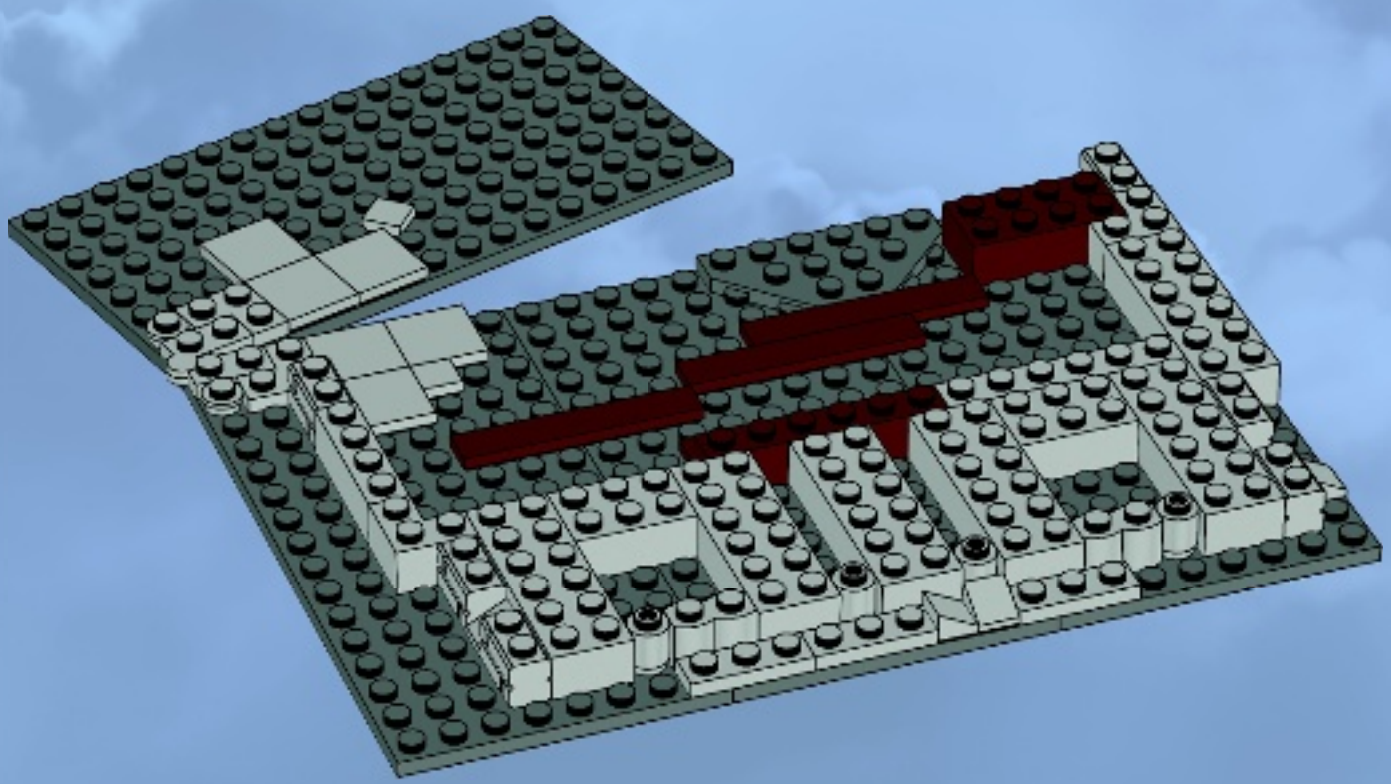

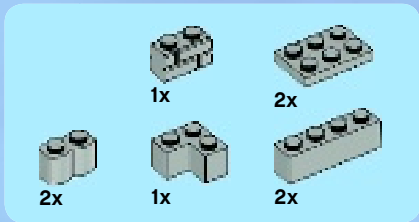

11

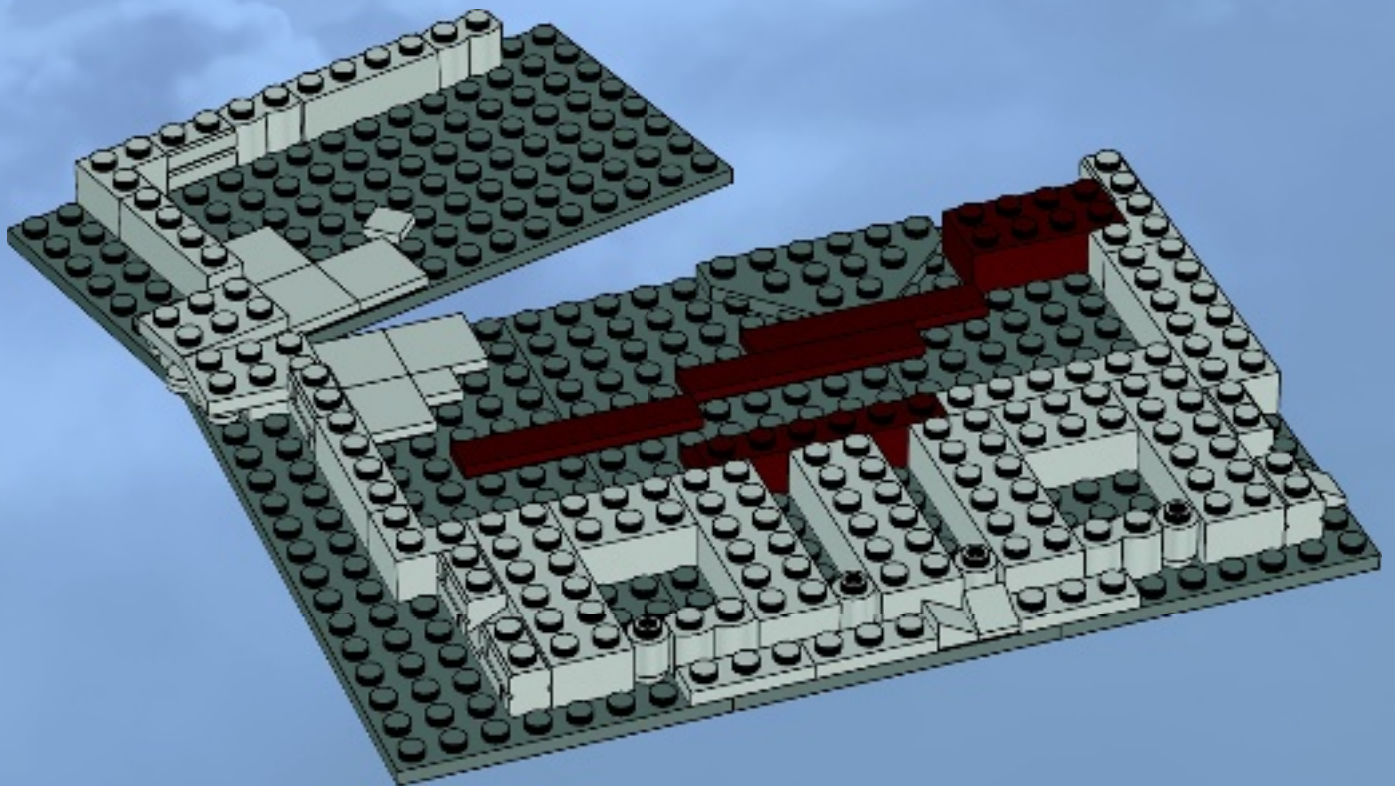



12

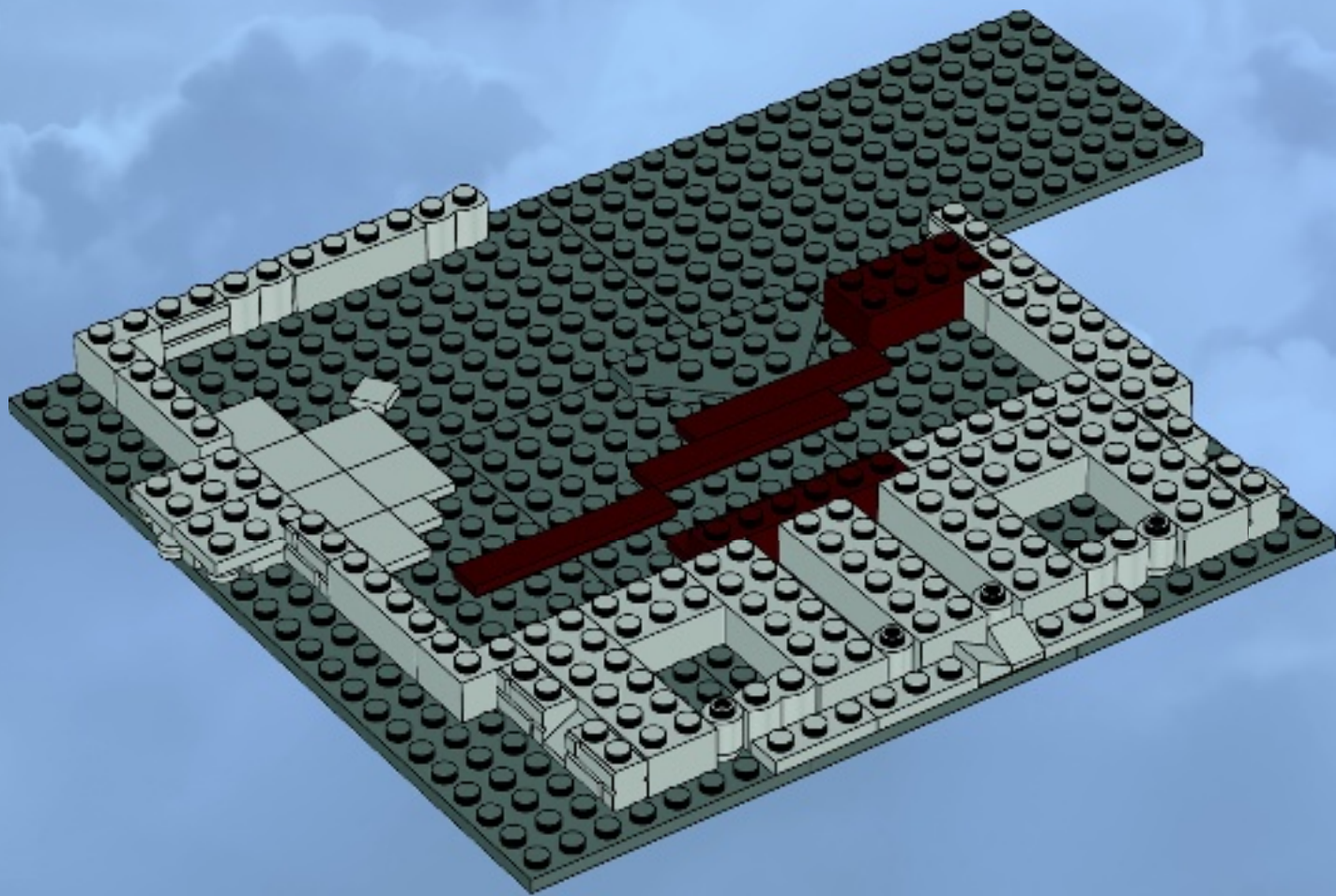

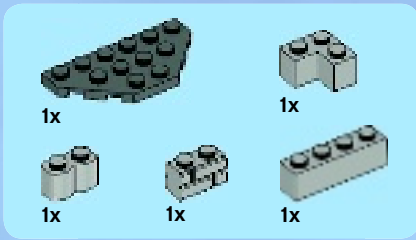

13

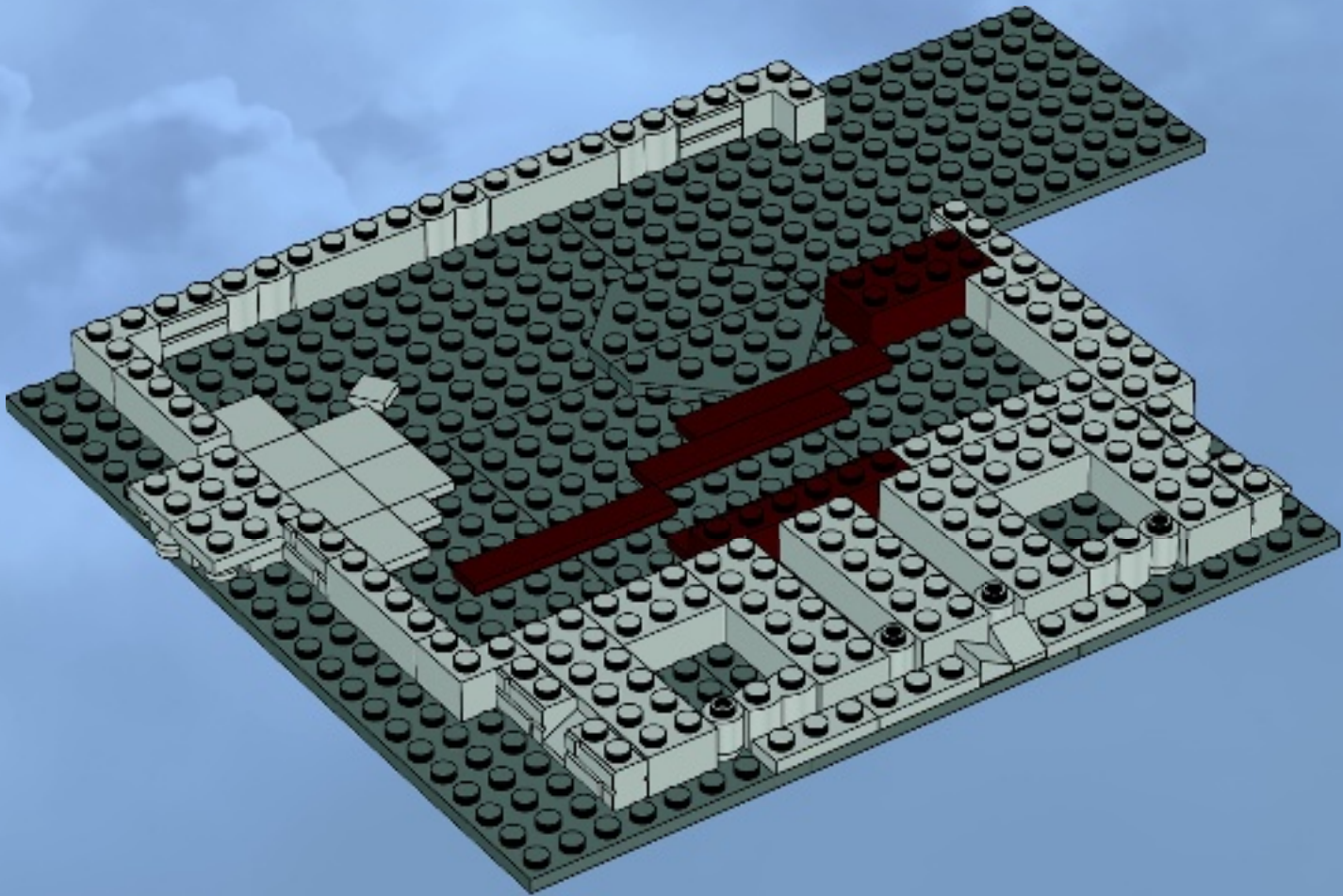

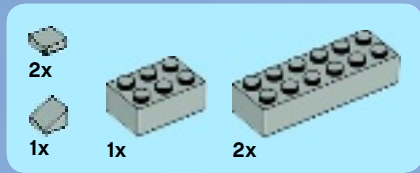

14

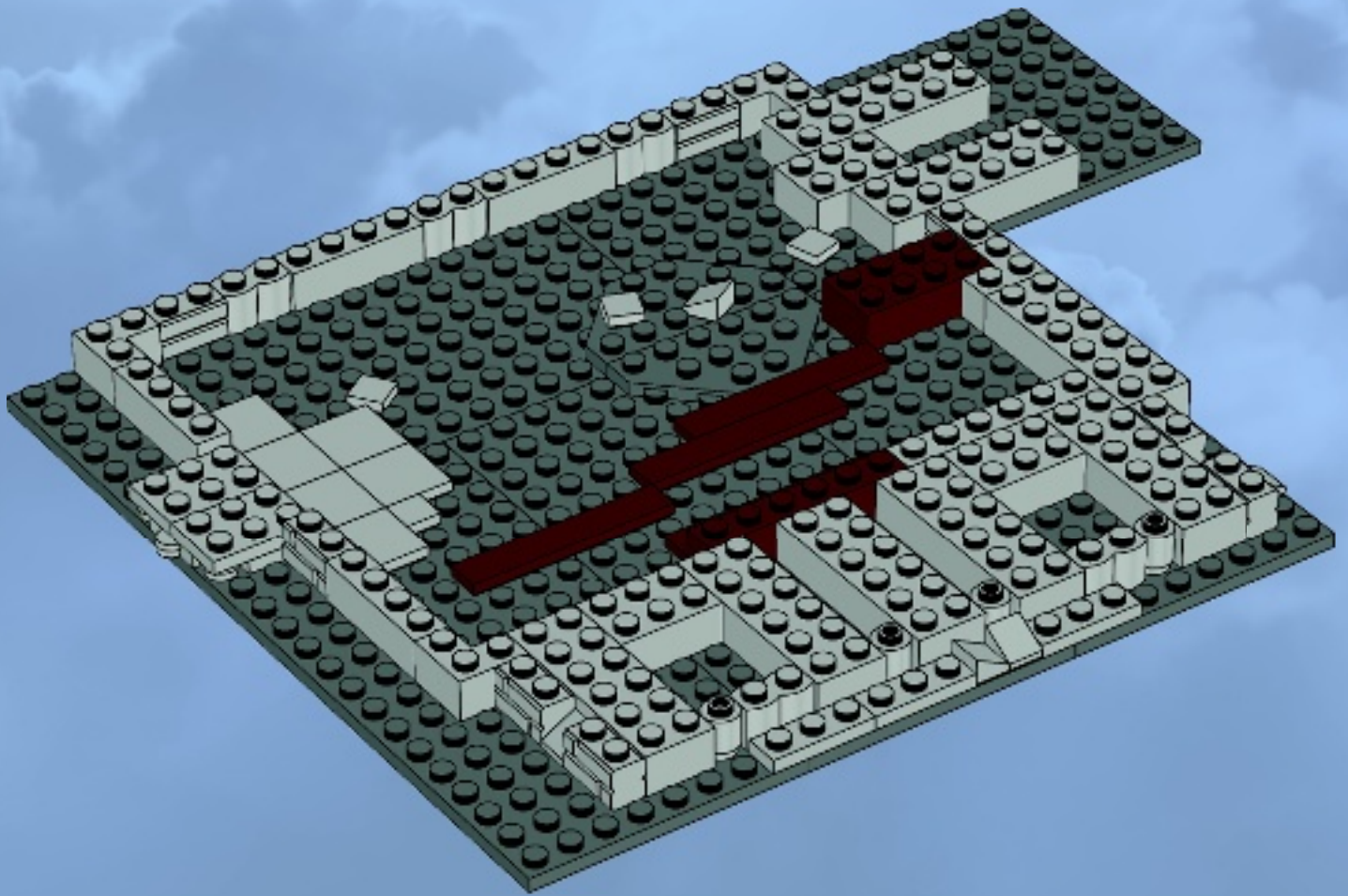

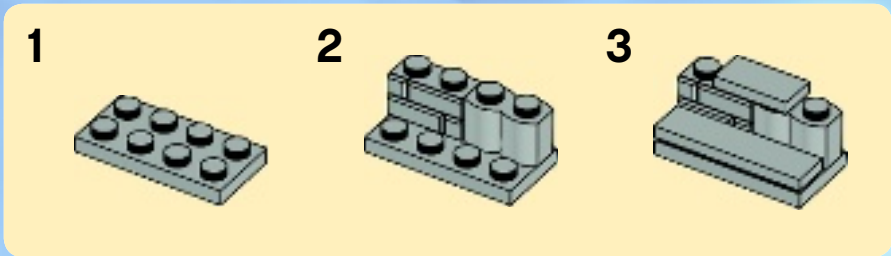
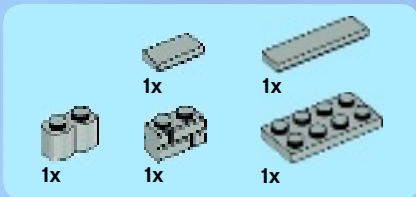

15

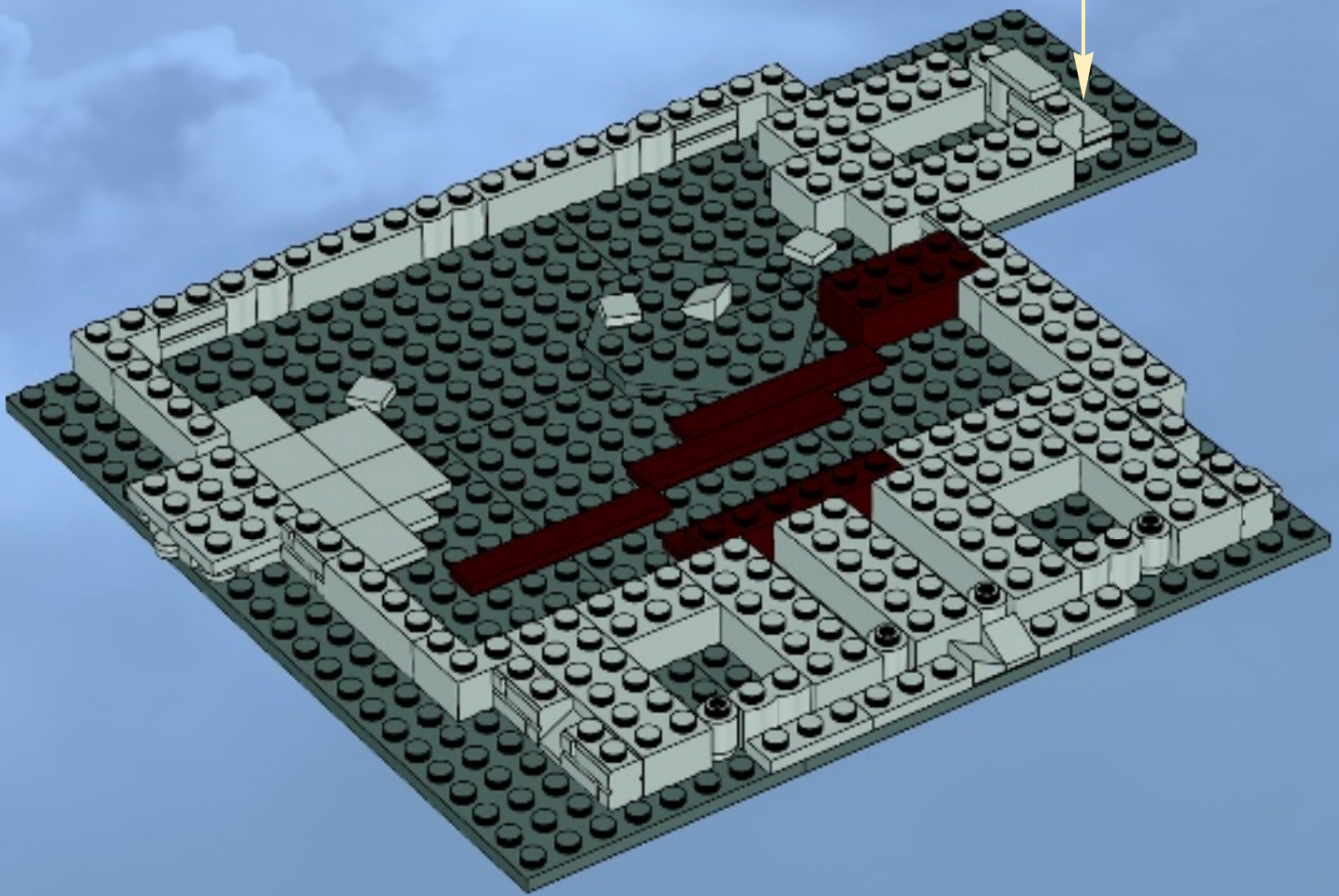

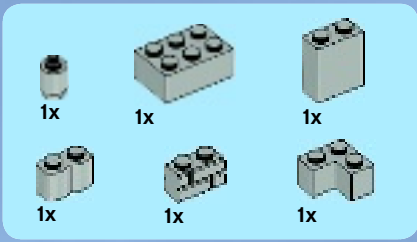

16

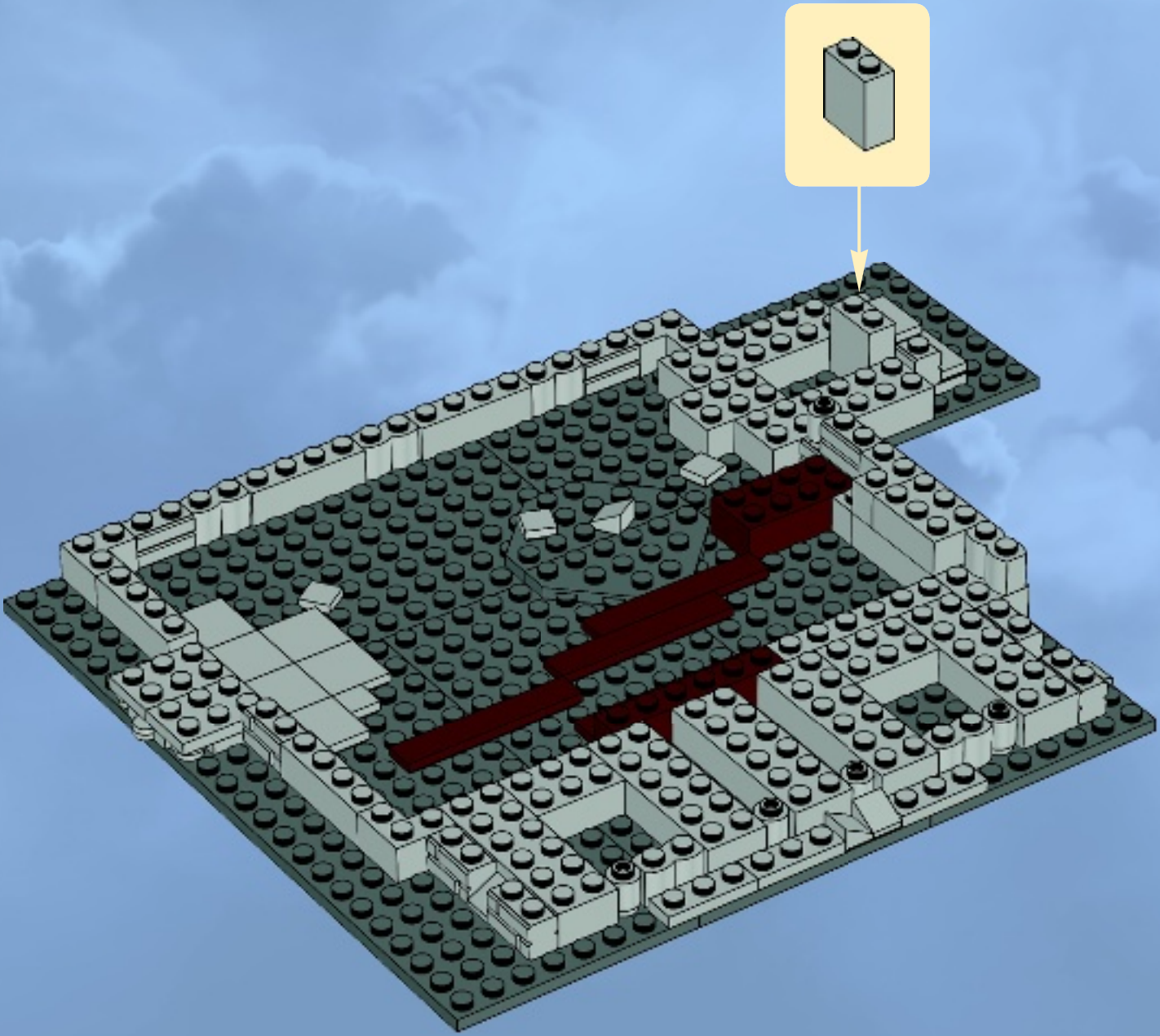

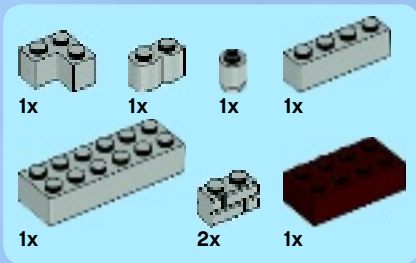

17

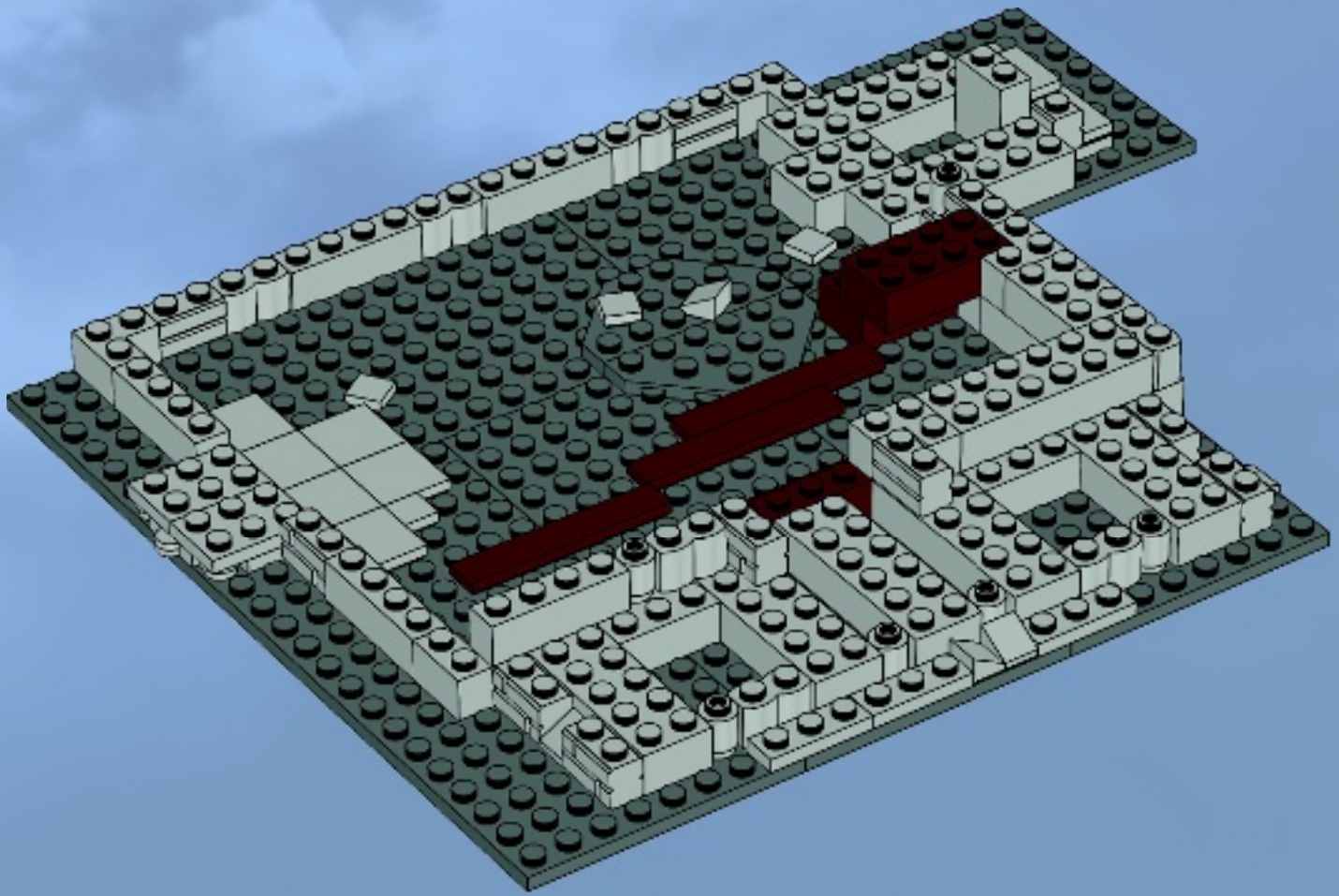

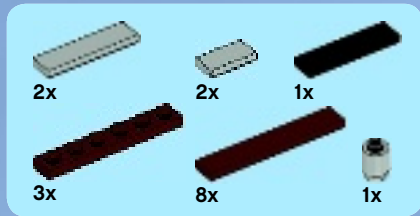

18

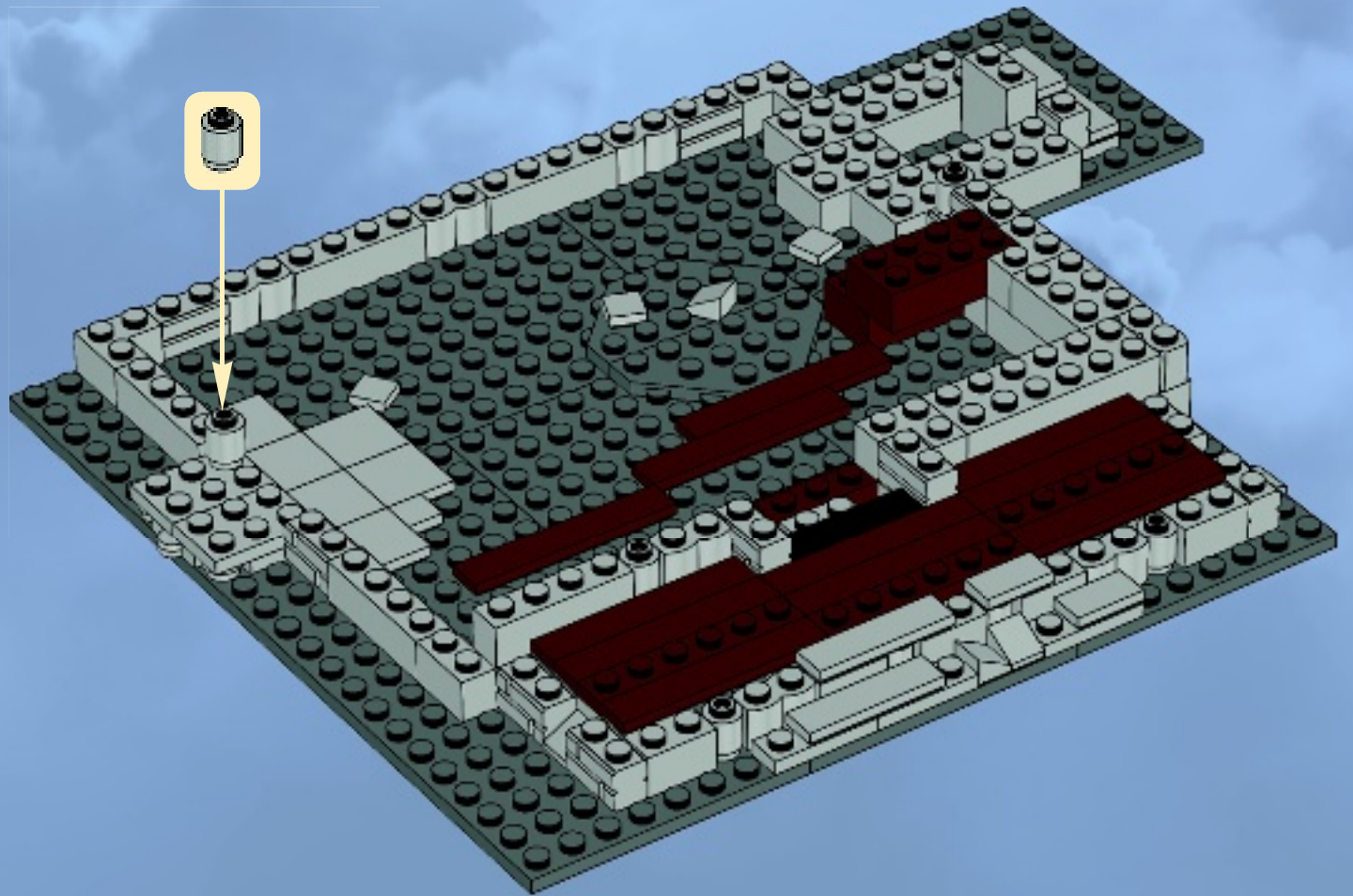



1x

1



1x



1x

2

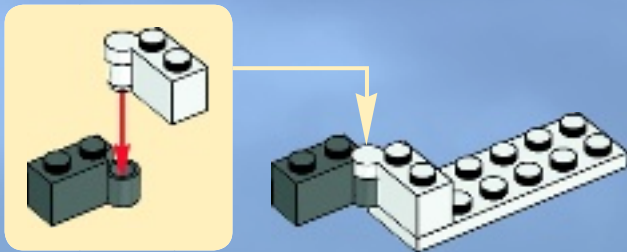

1x



1x



2x

3

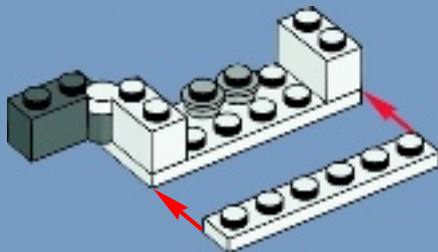

2x



2x

4

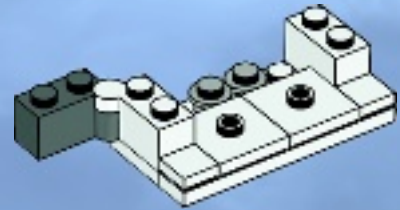

1x



1x

5

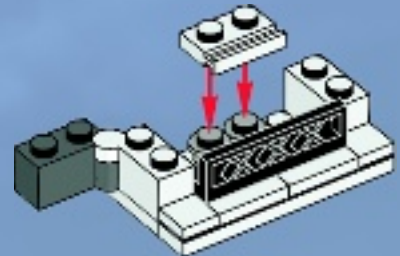

2x

6





2x



1x



2x

7

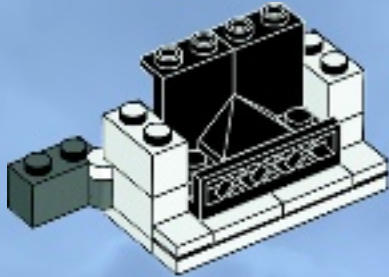

2x



1x

8

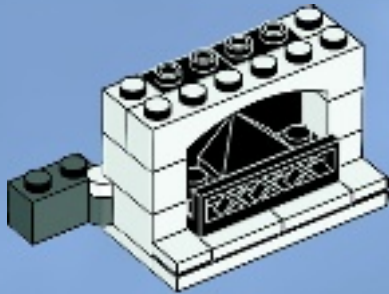

1x



3x

9

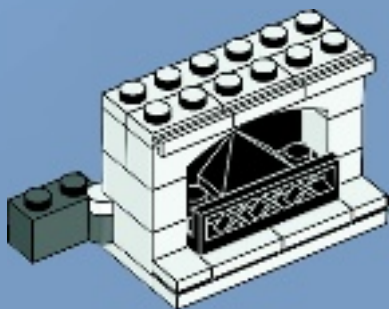

4x

10

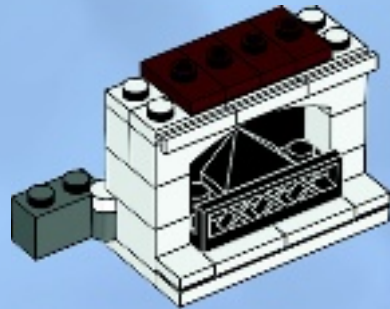

1x



2x

11

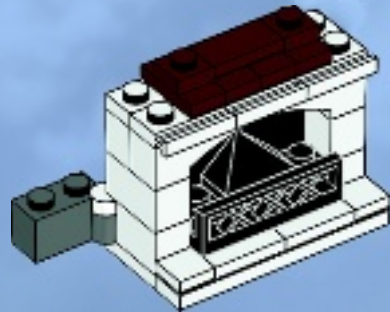

1x



1x

12

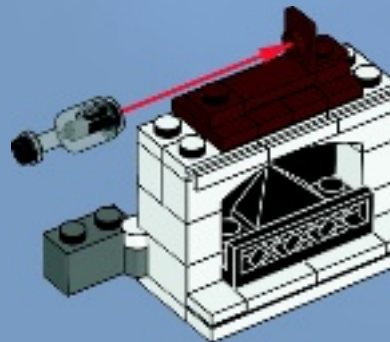

19

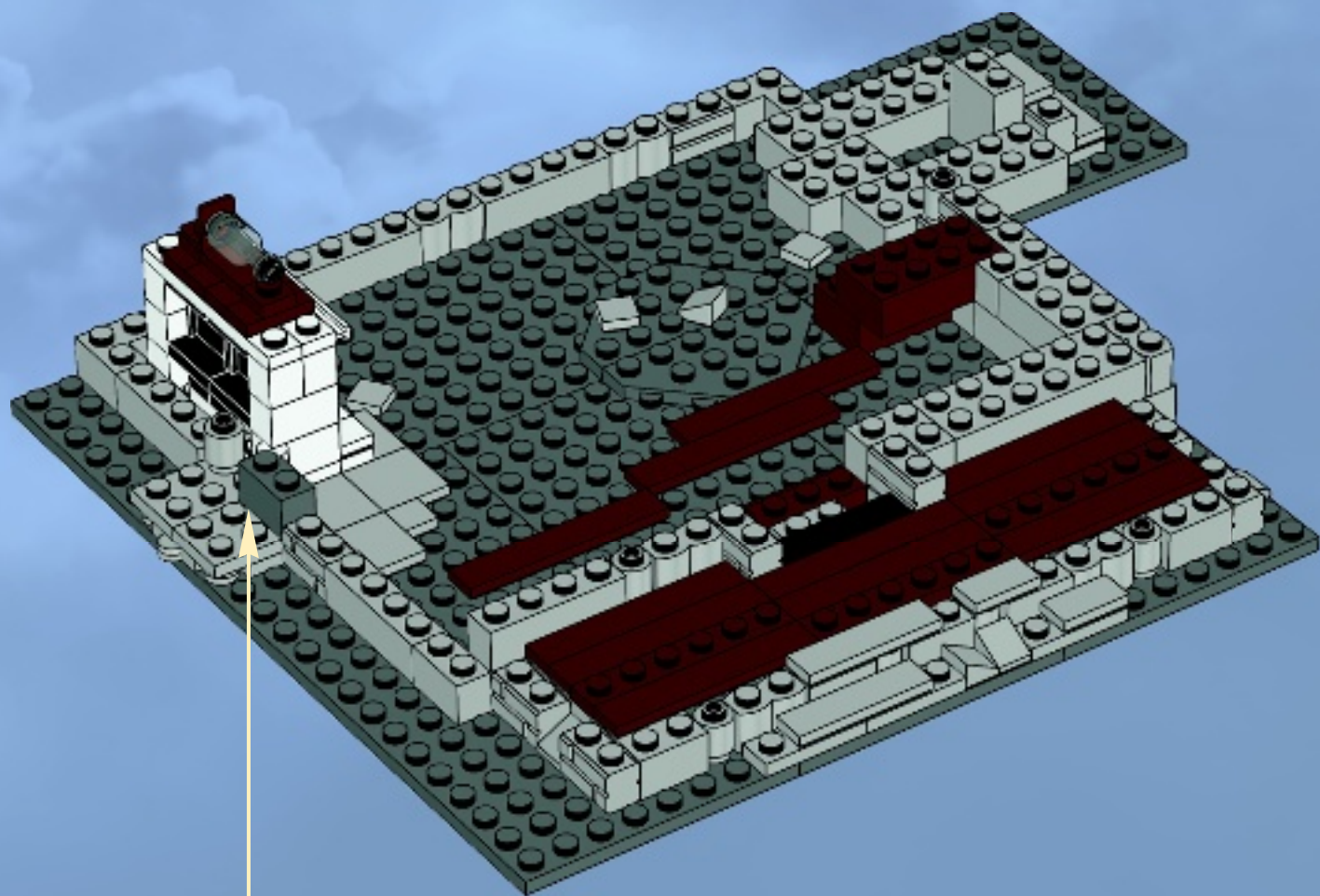

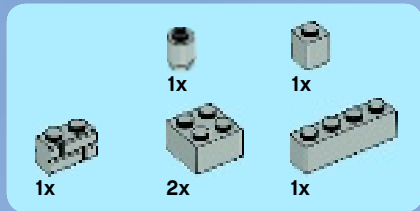

20

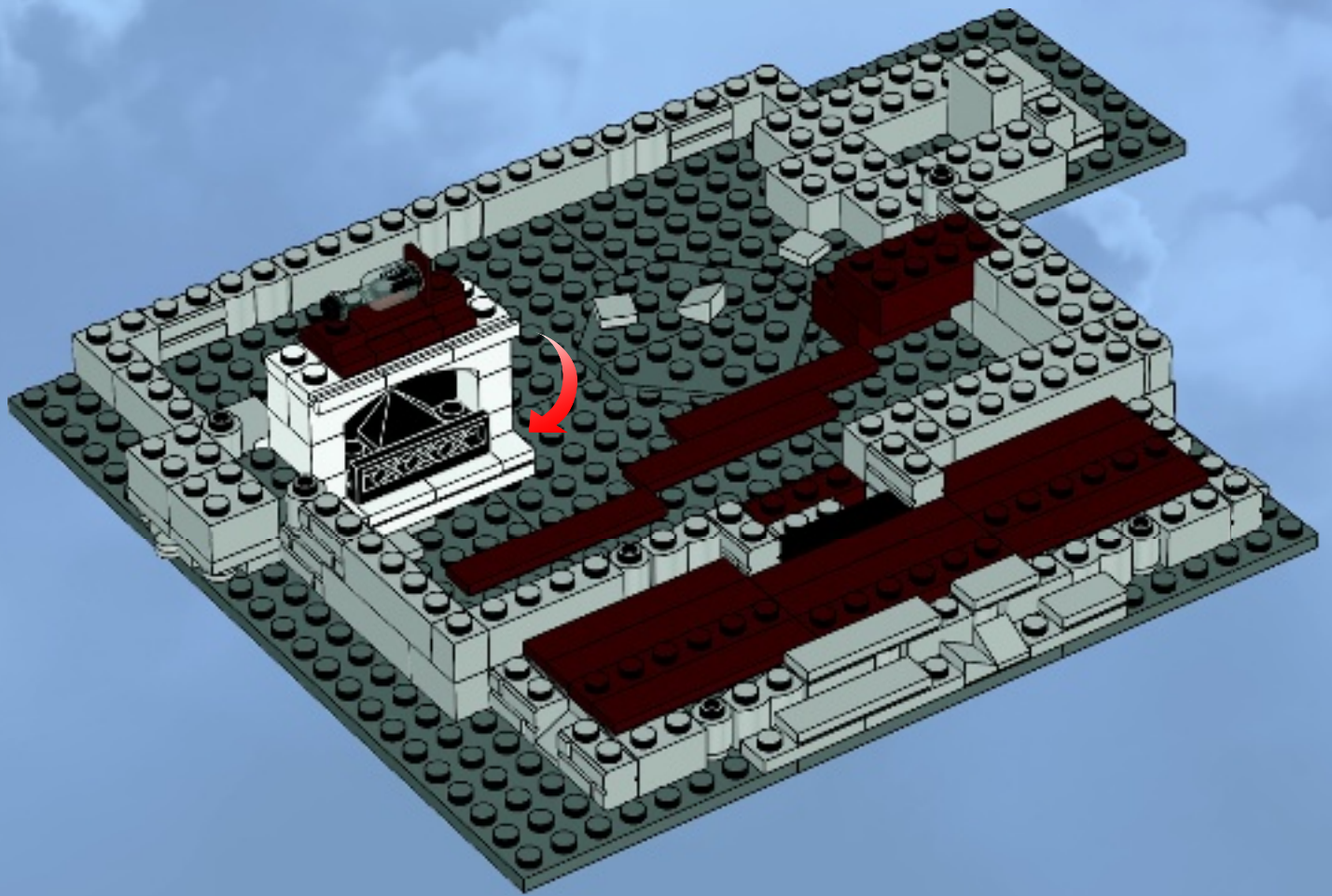

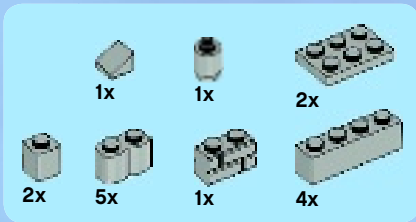

21

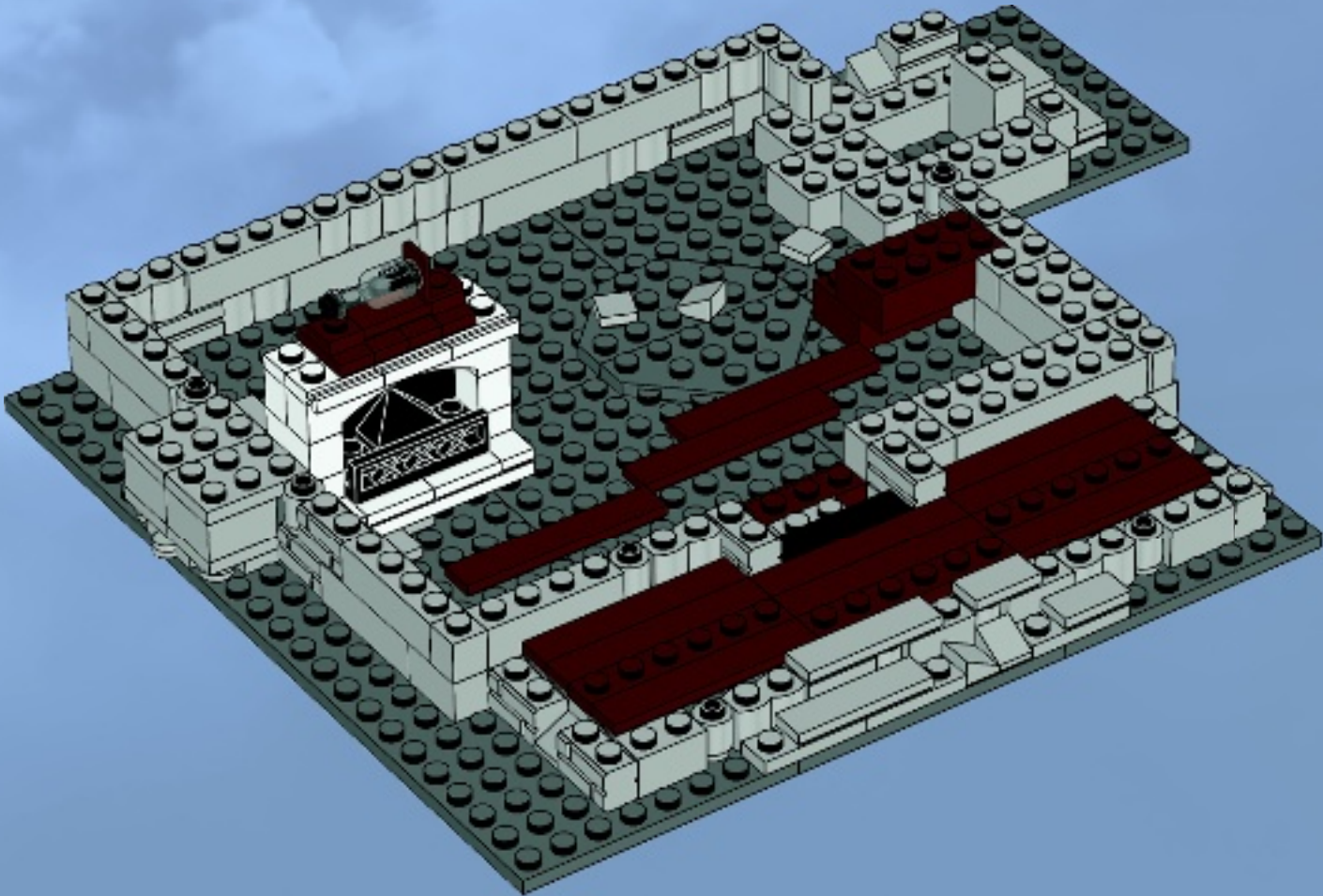

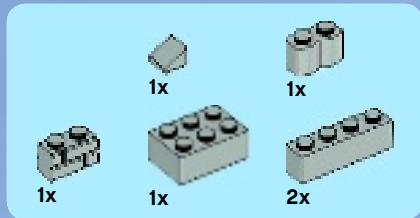

22

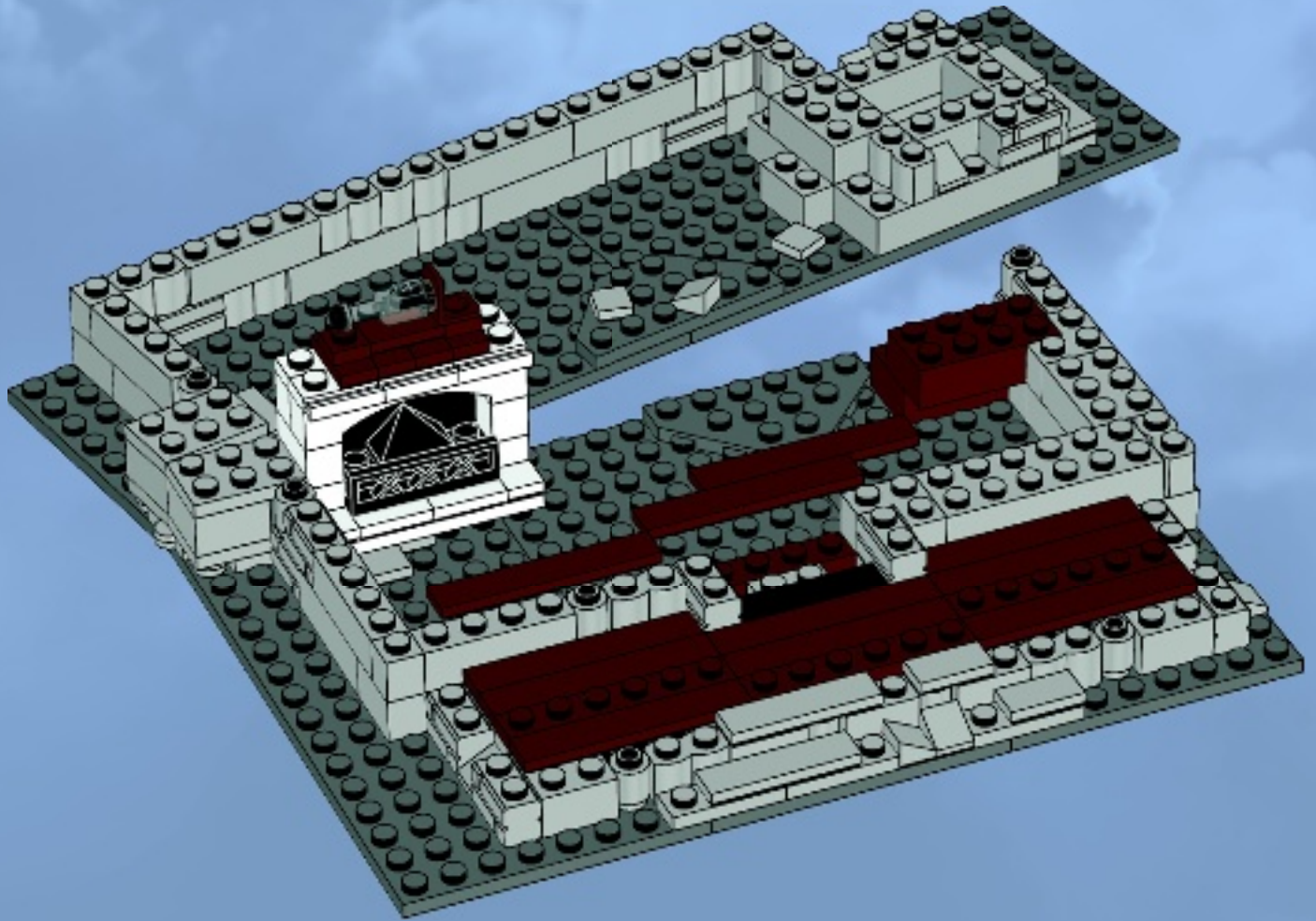

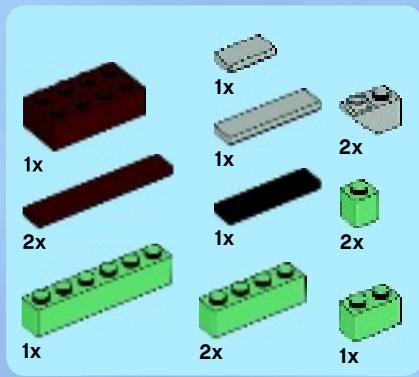

23

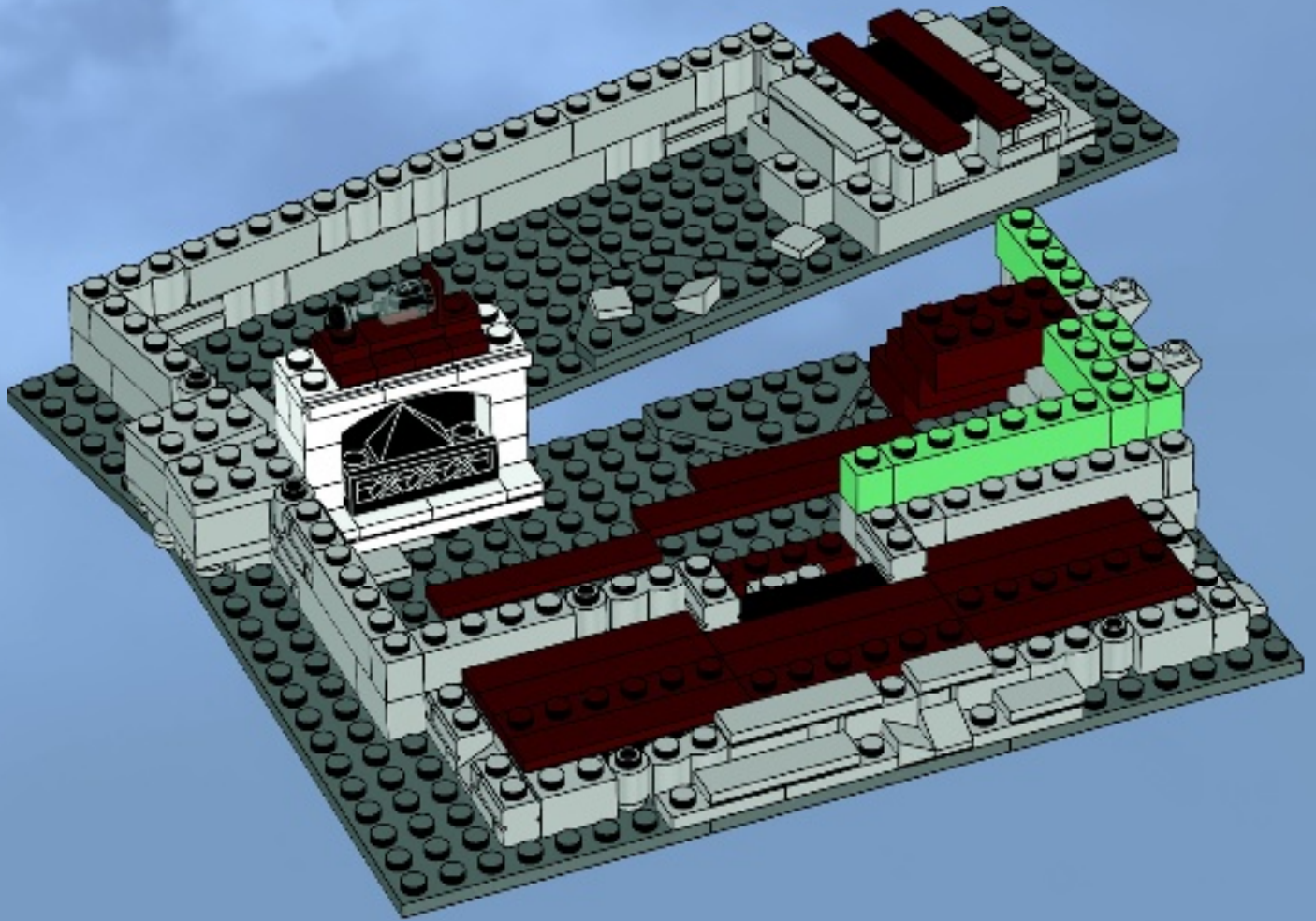

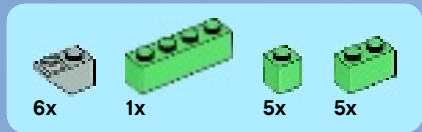

24

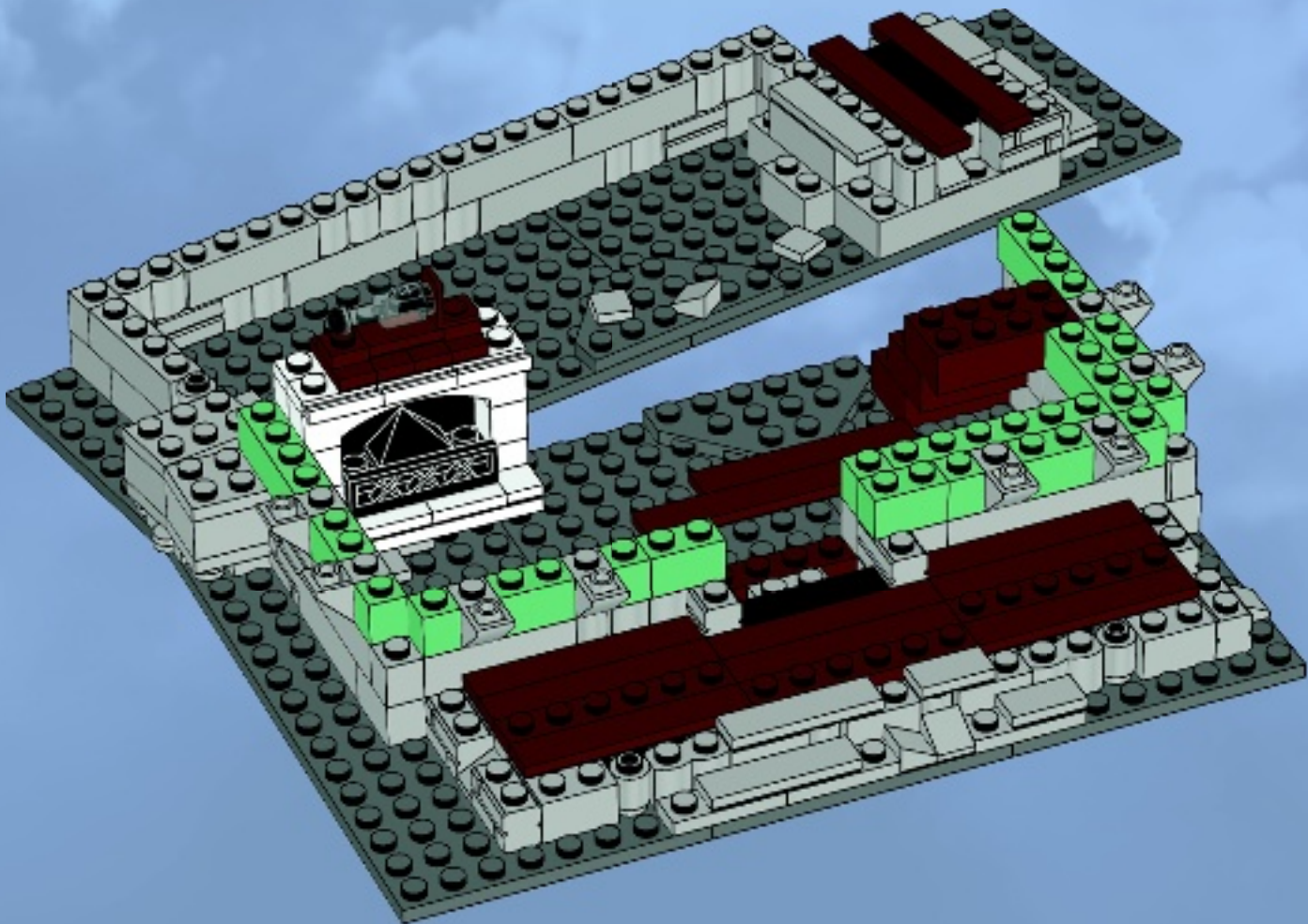

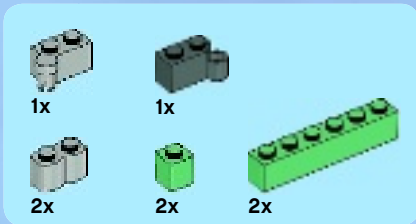

25

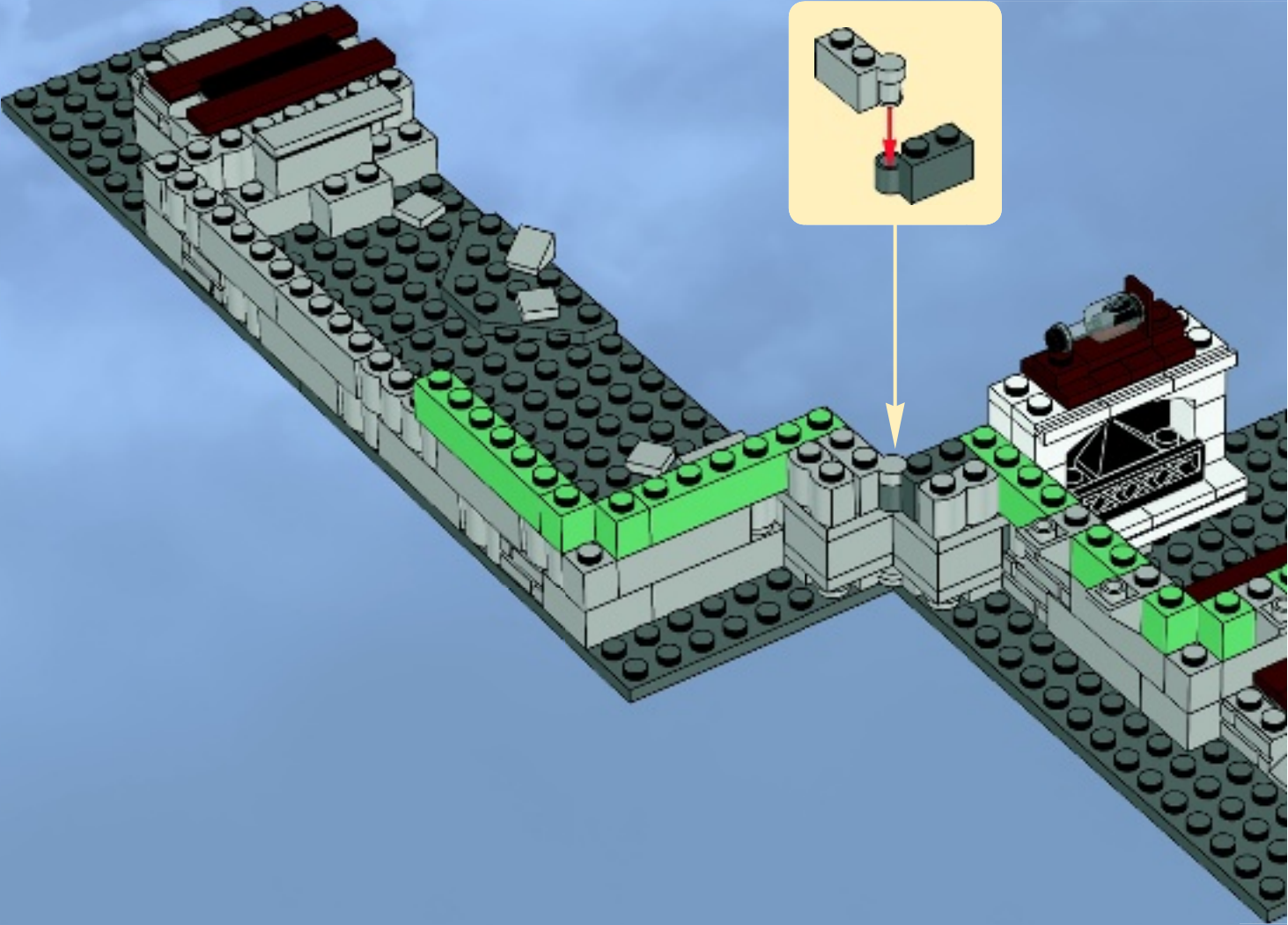

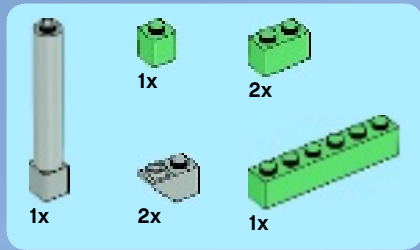

26

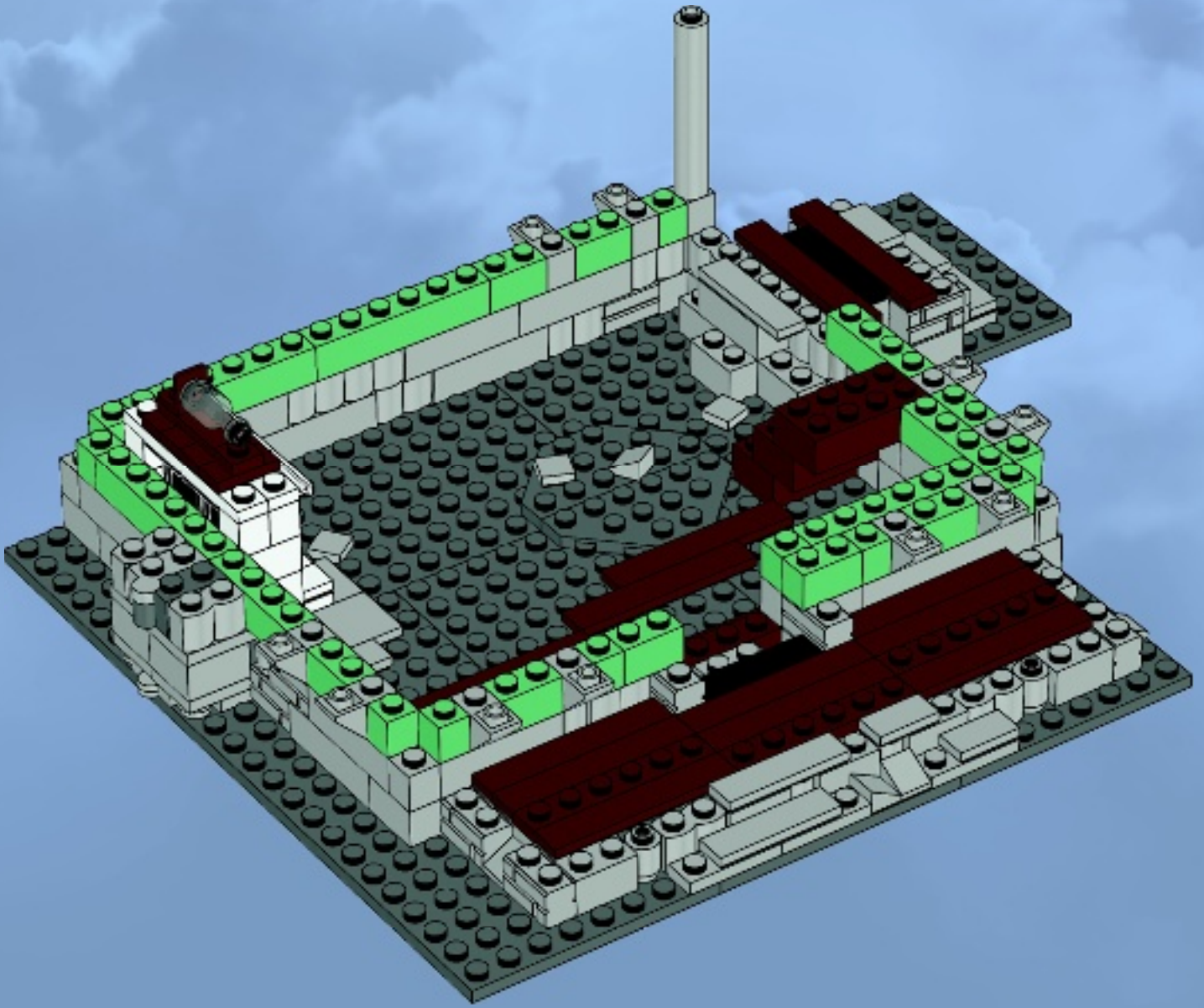

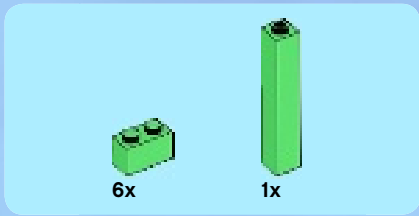

27

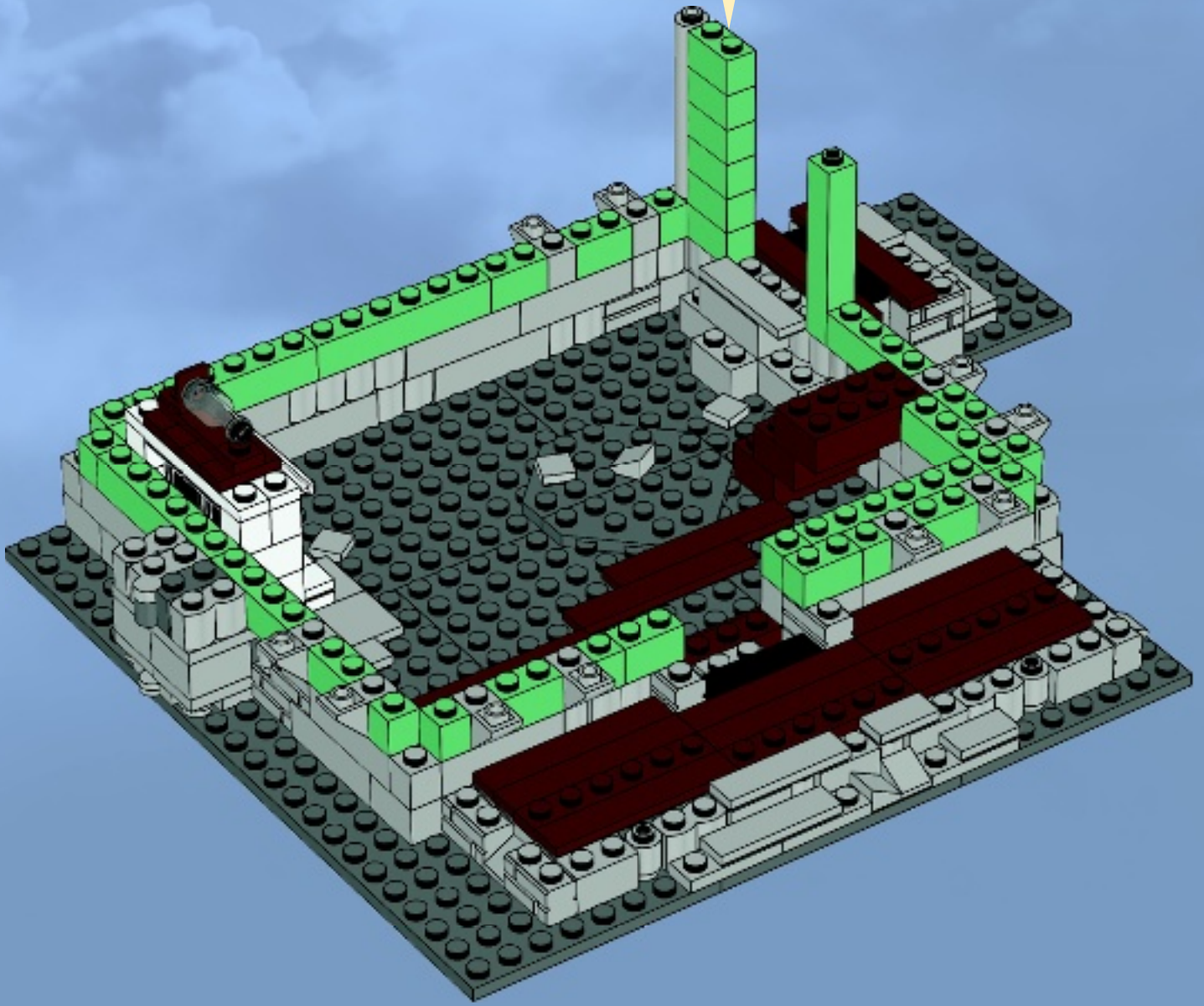
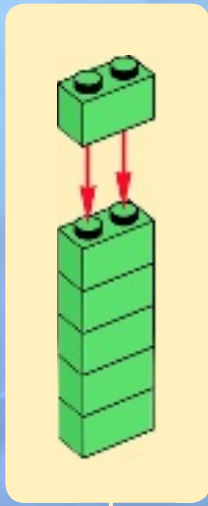

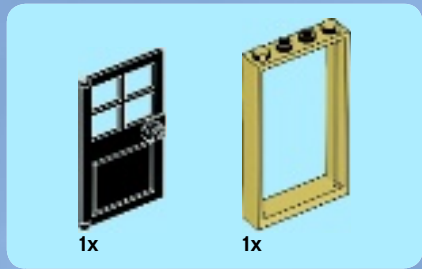

28

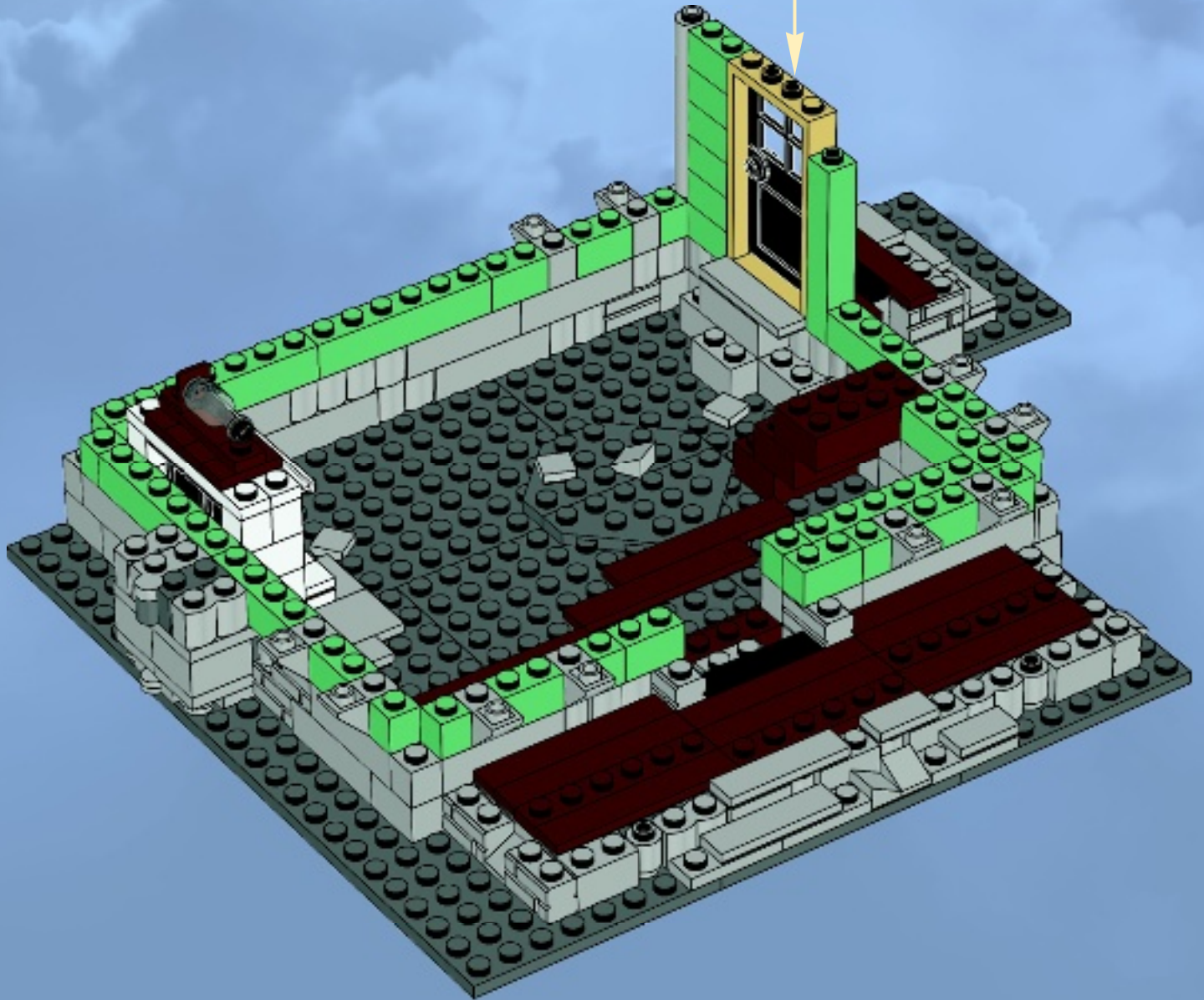
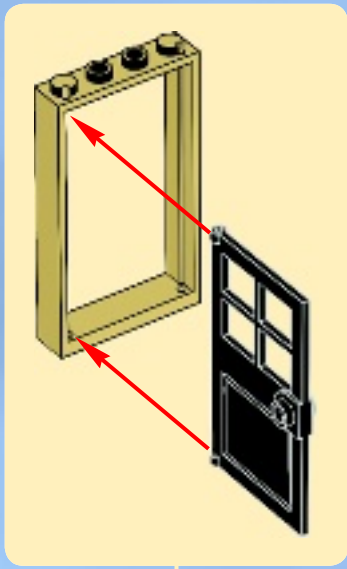

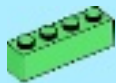

4x

29

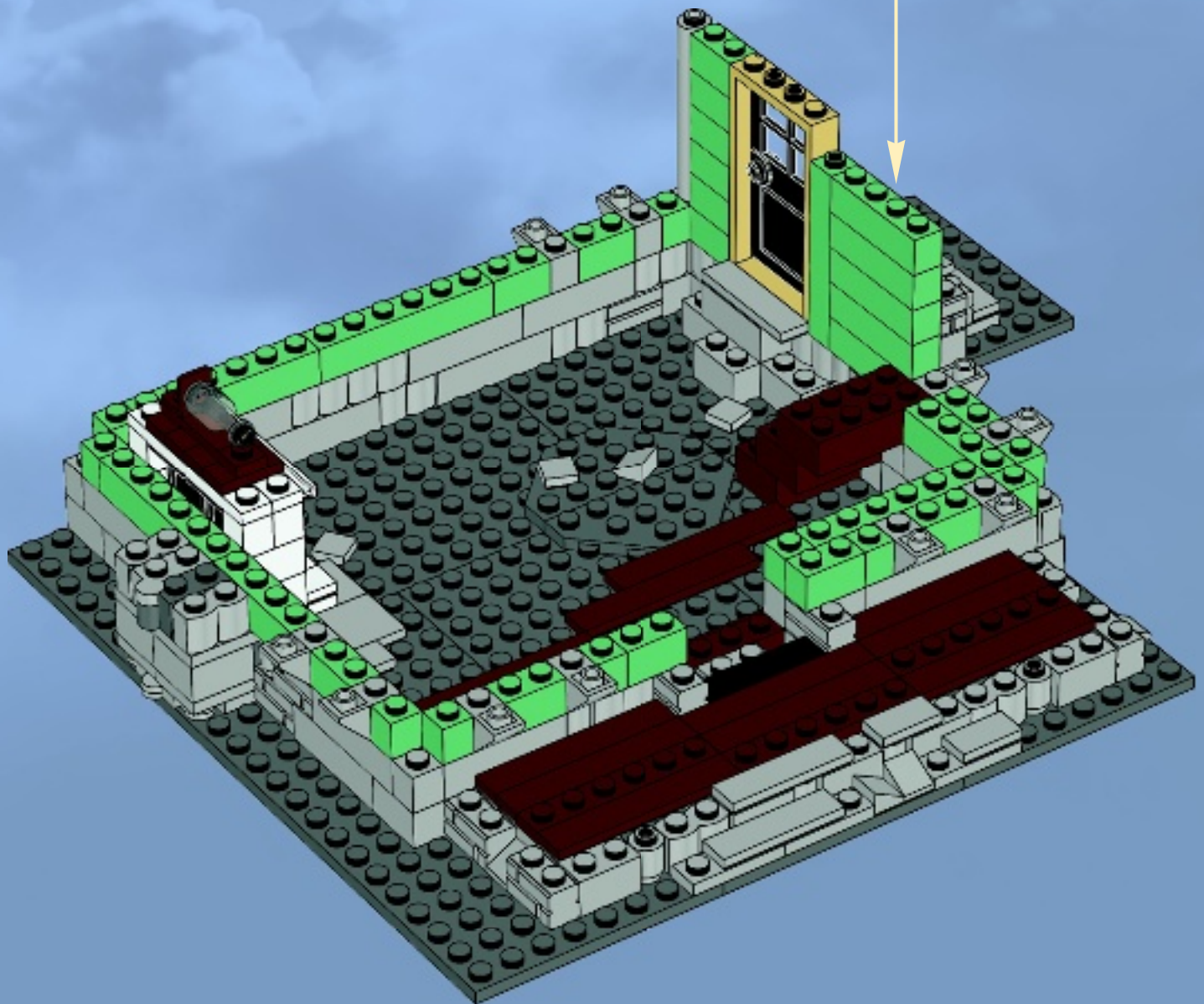
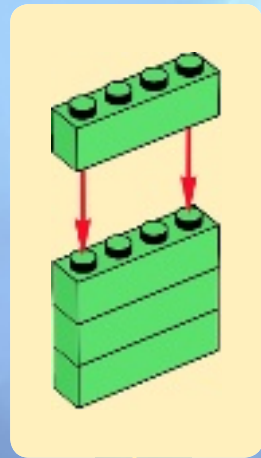

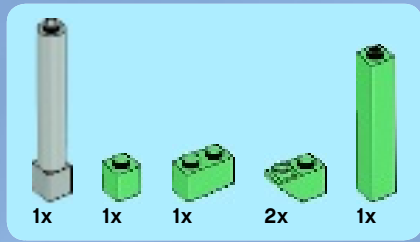

30

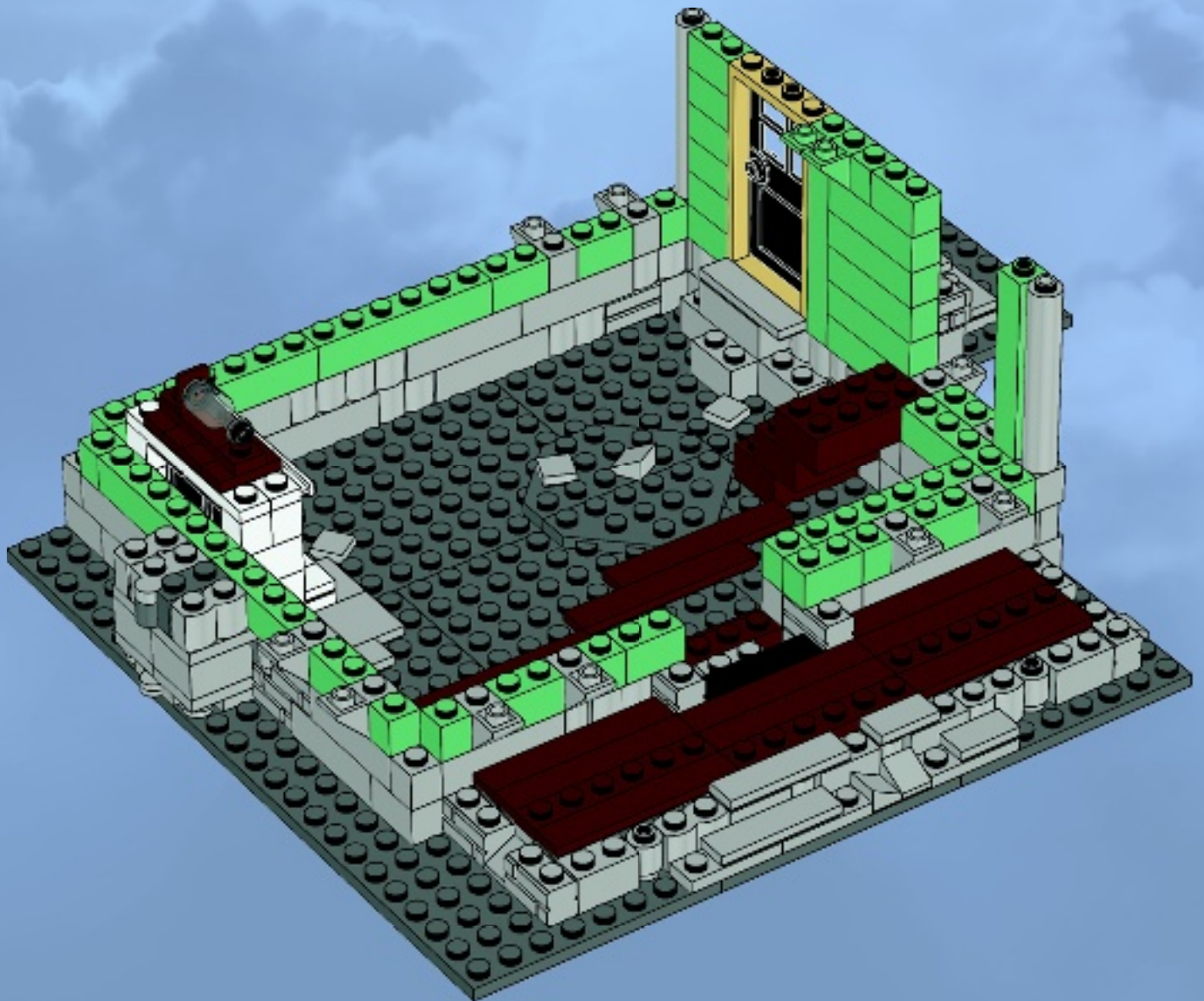



1x

1

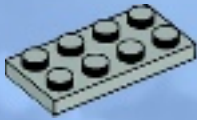

1x



2x

2



1x



2x



1x

3

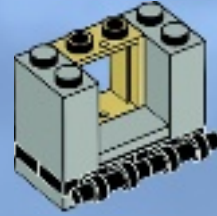

1x



1x



1x



1x

4

1

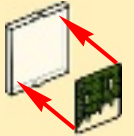

2

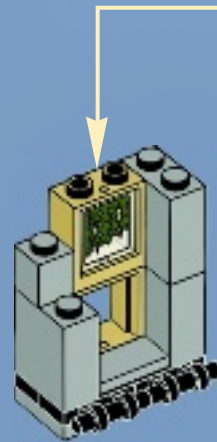



1x

5

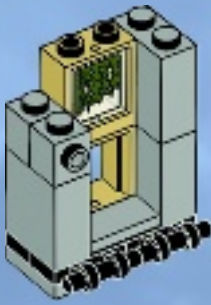

1x



1x

6

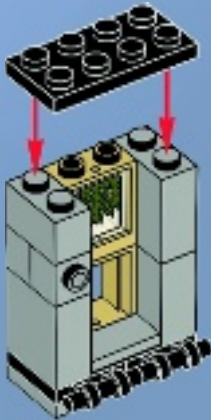

1x



2x

7

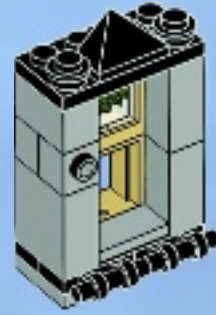

2x



1x

8



31

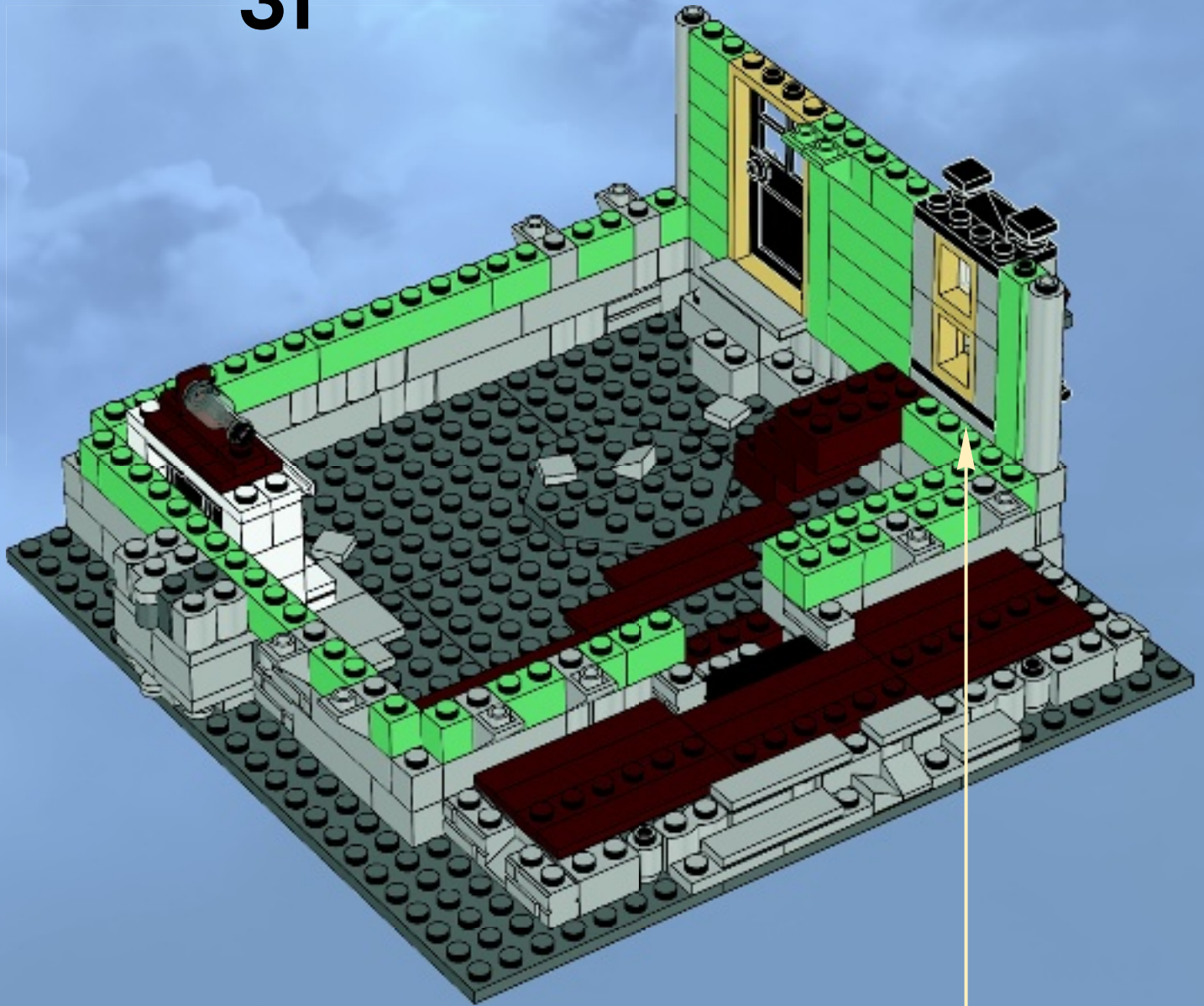

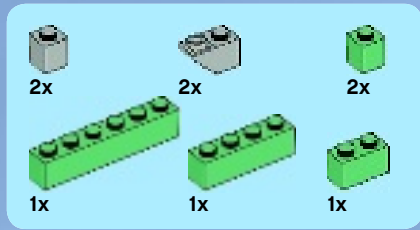

32

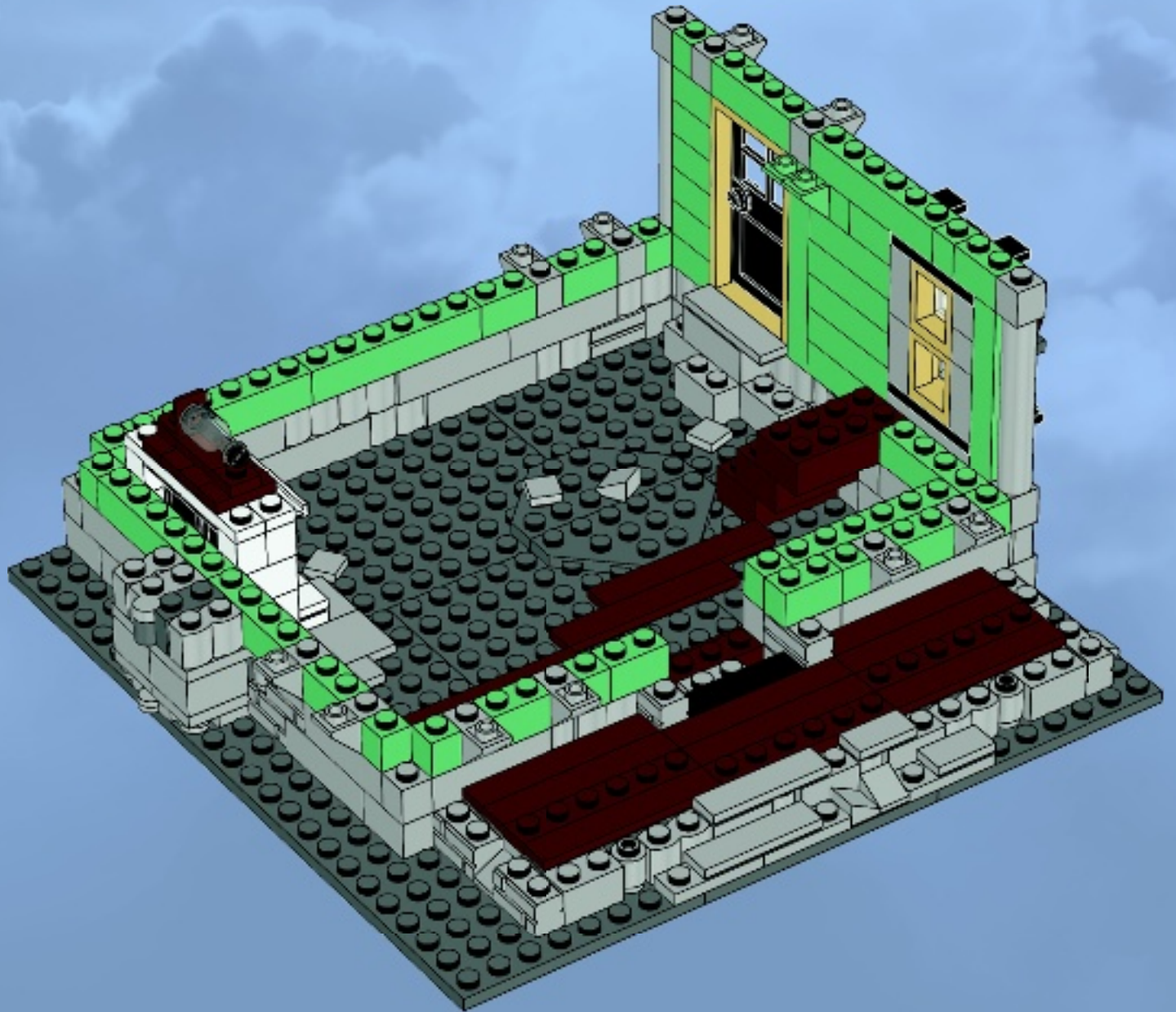

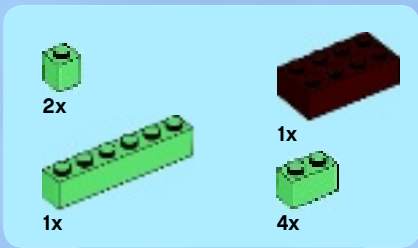

33

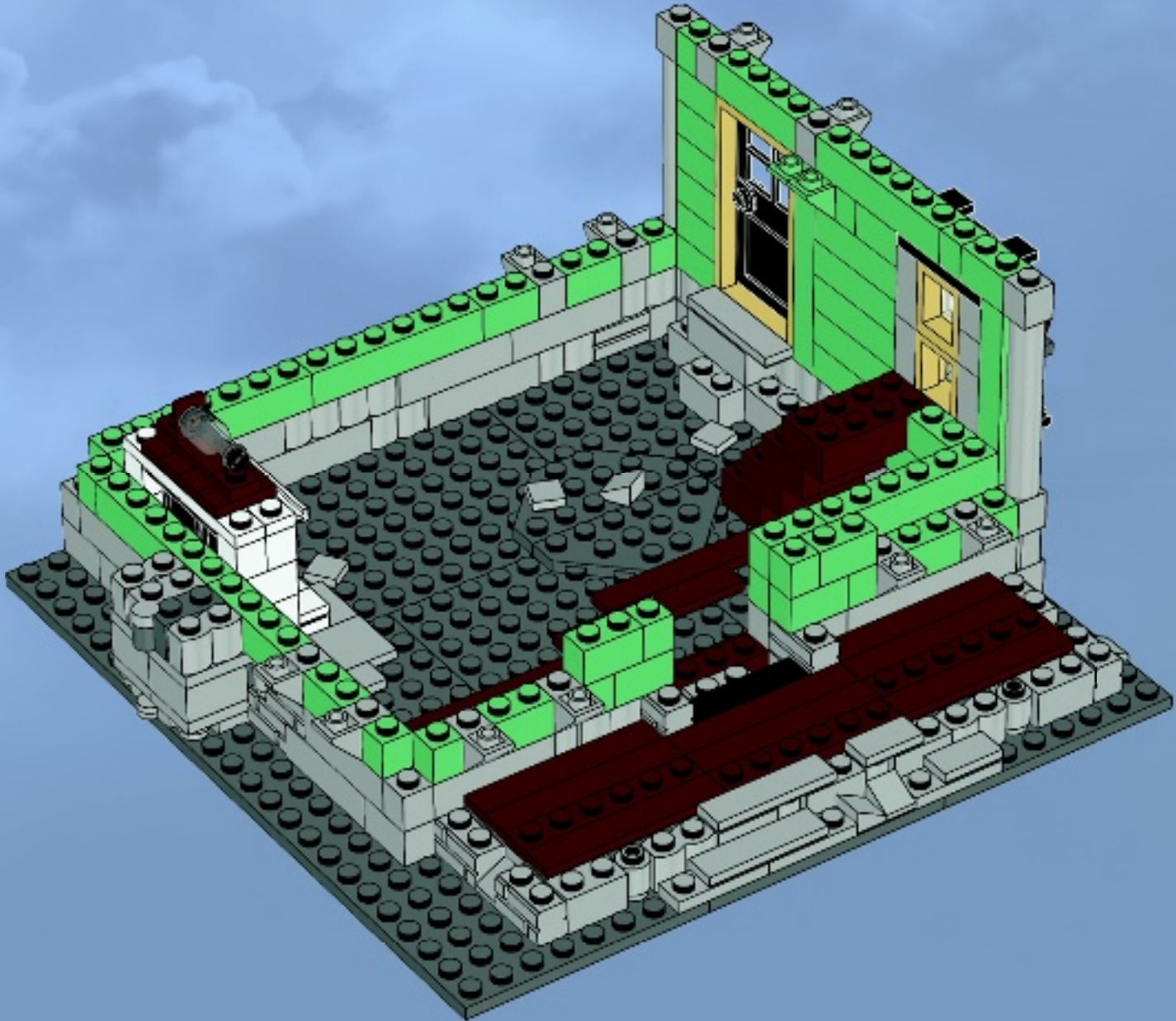

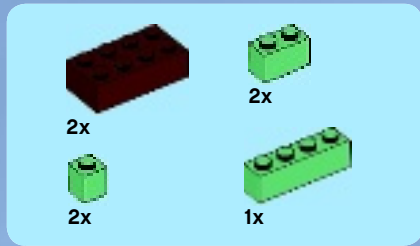

34

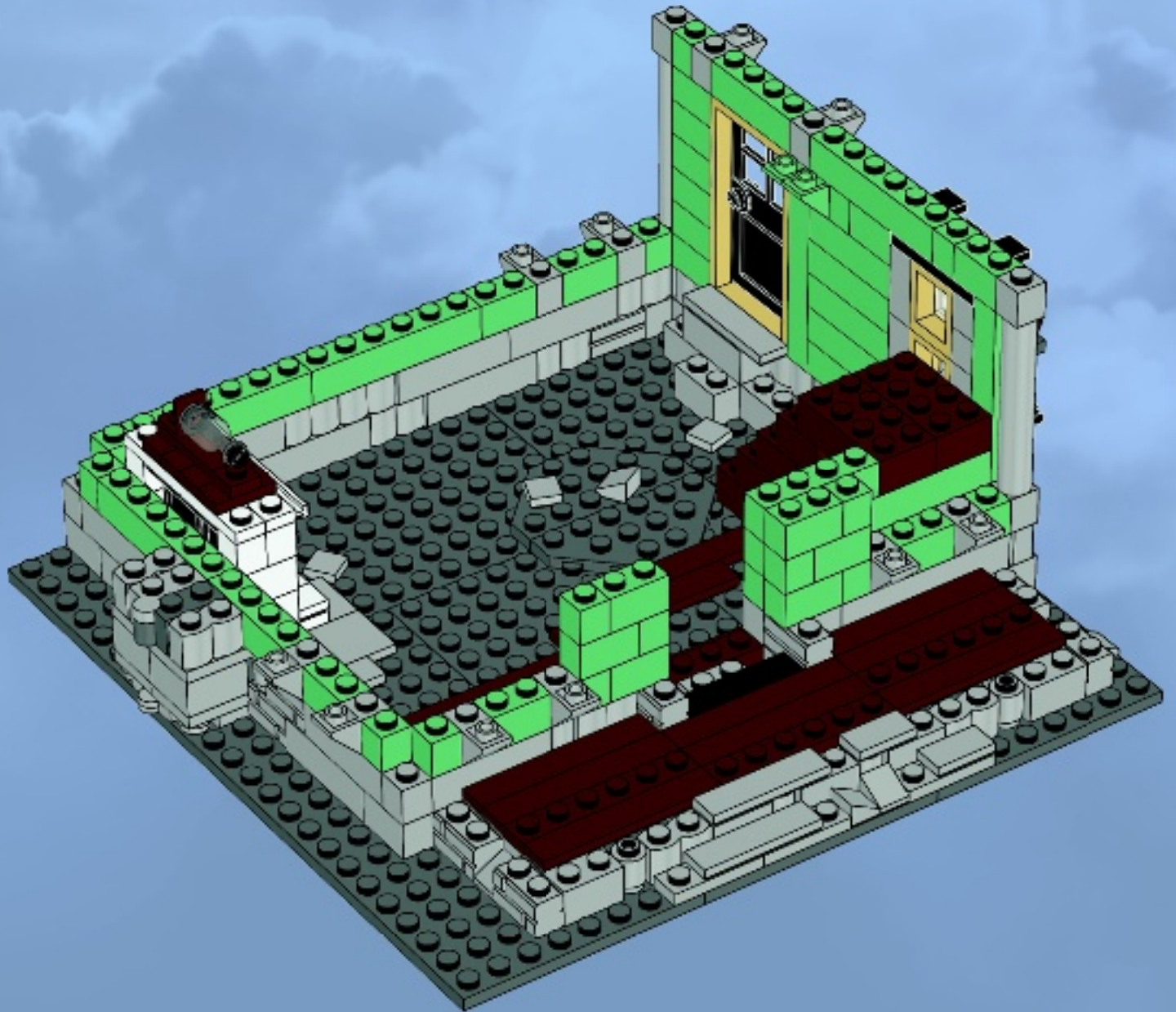



35

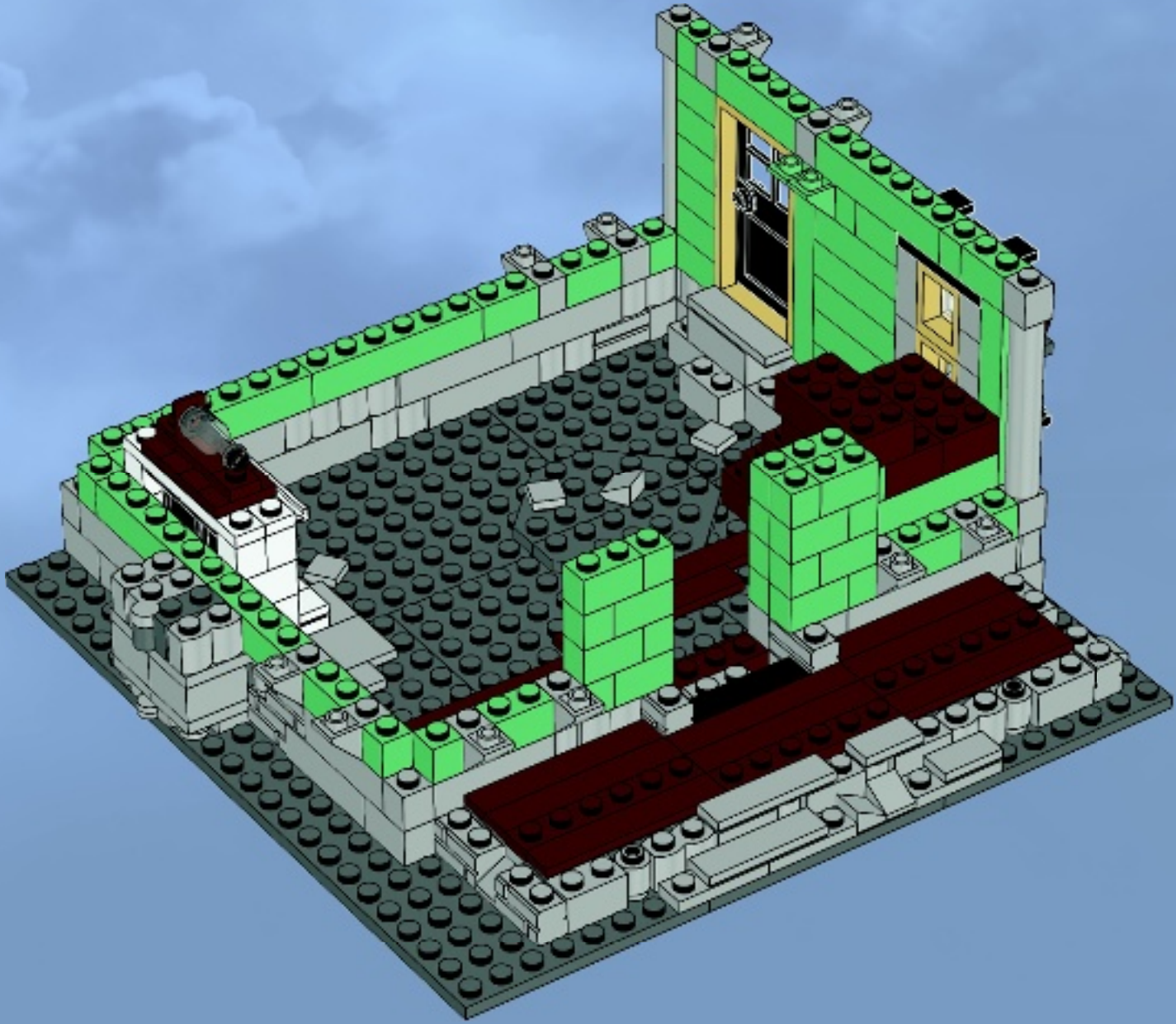

1x  2x  3x 

36

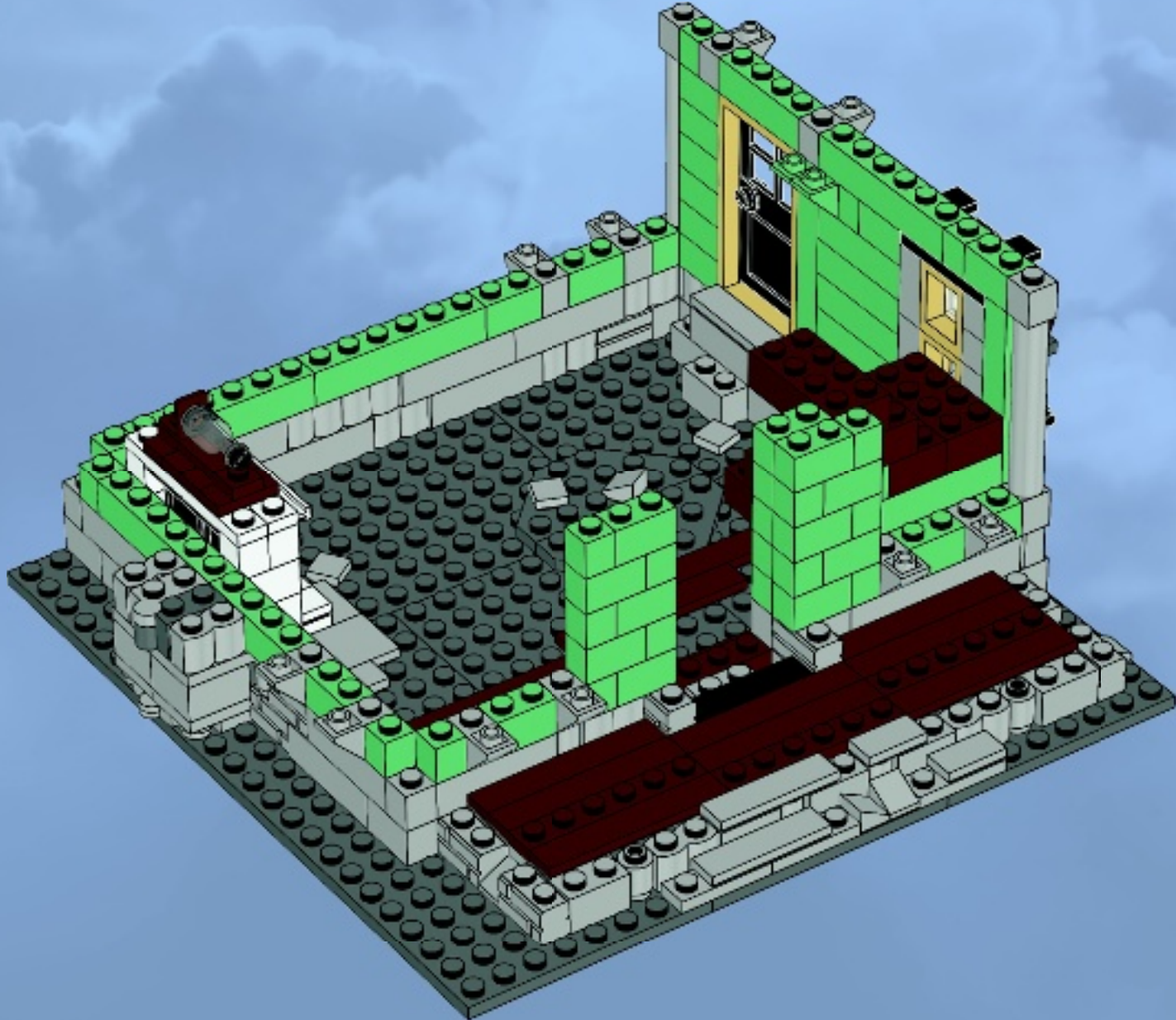



37

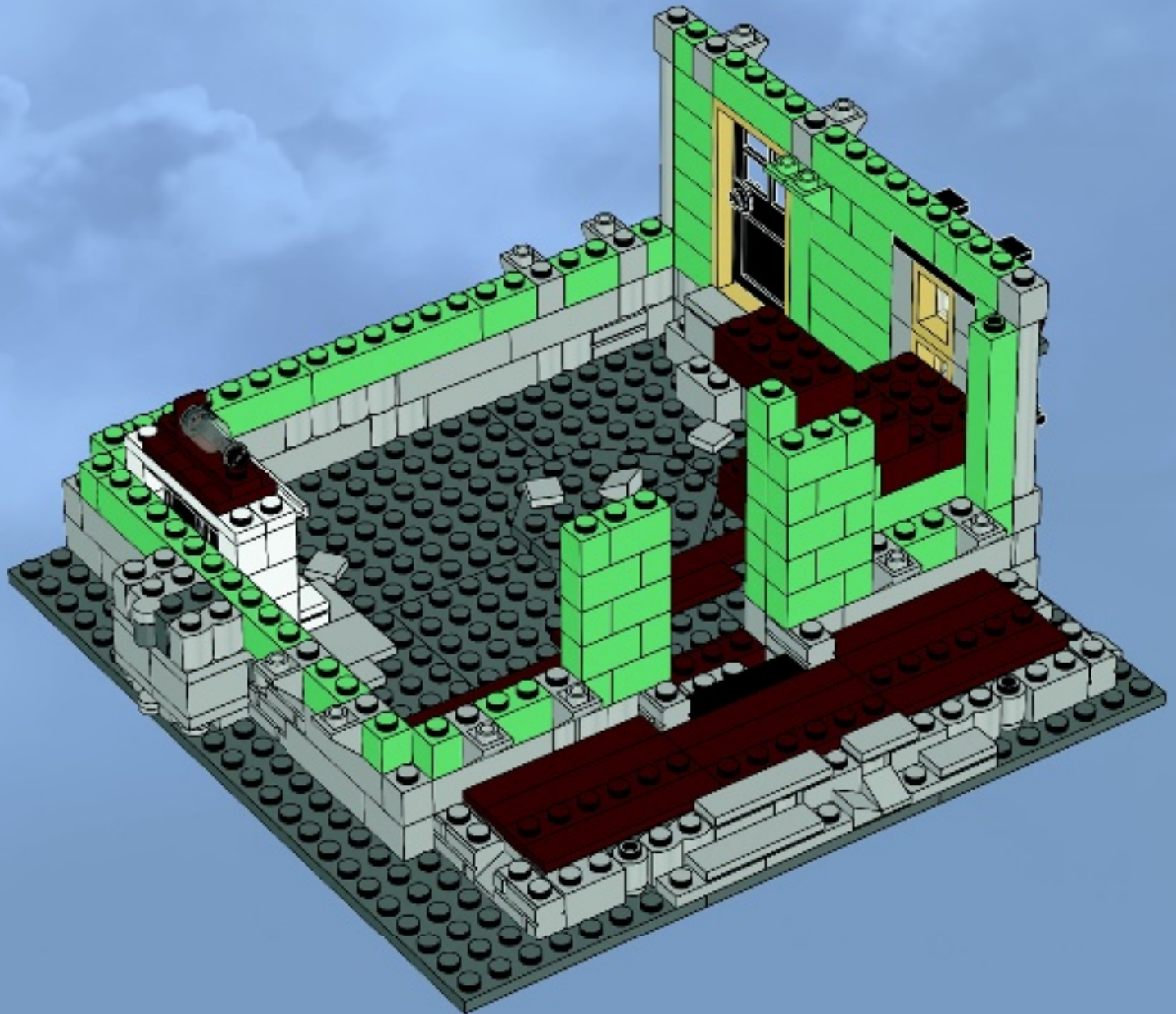



1x

1

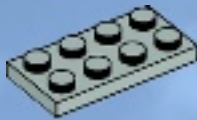

1x



2x

2



1x



2x



1x

3

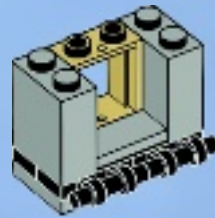

1x



1x

4

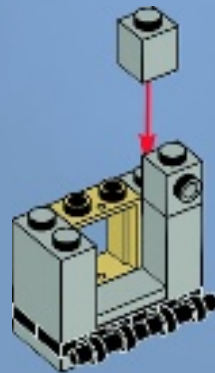



1x



1x

5

1

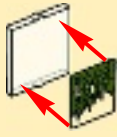

2



1x



2x

7

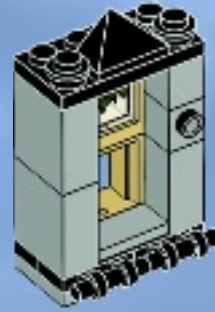

1x



1x



1x

6

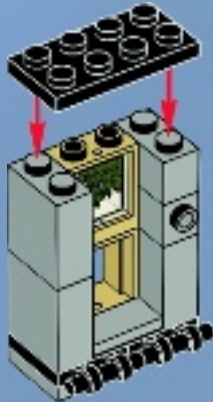

2x



1x

8



38

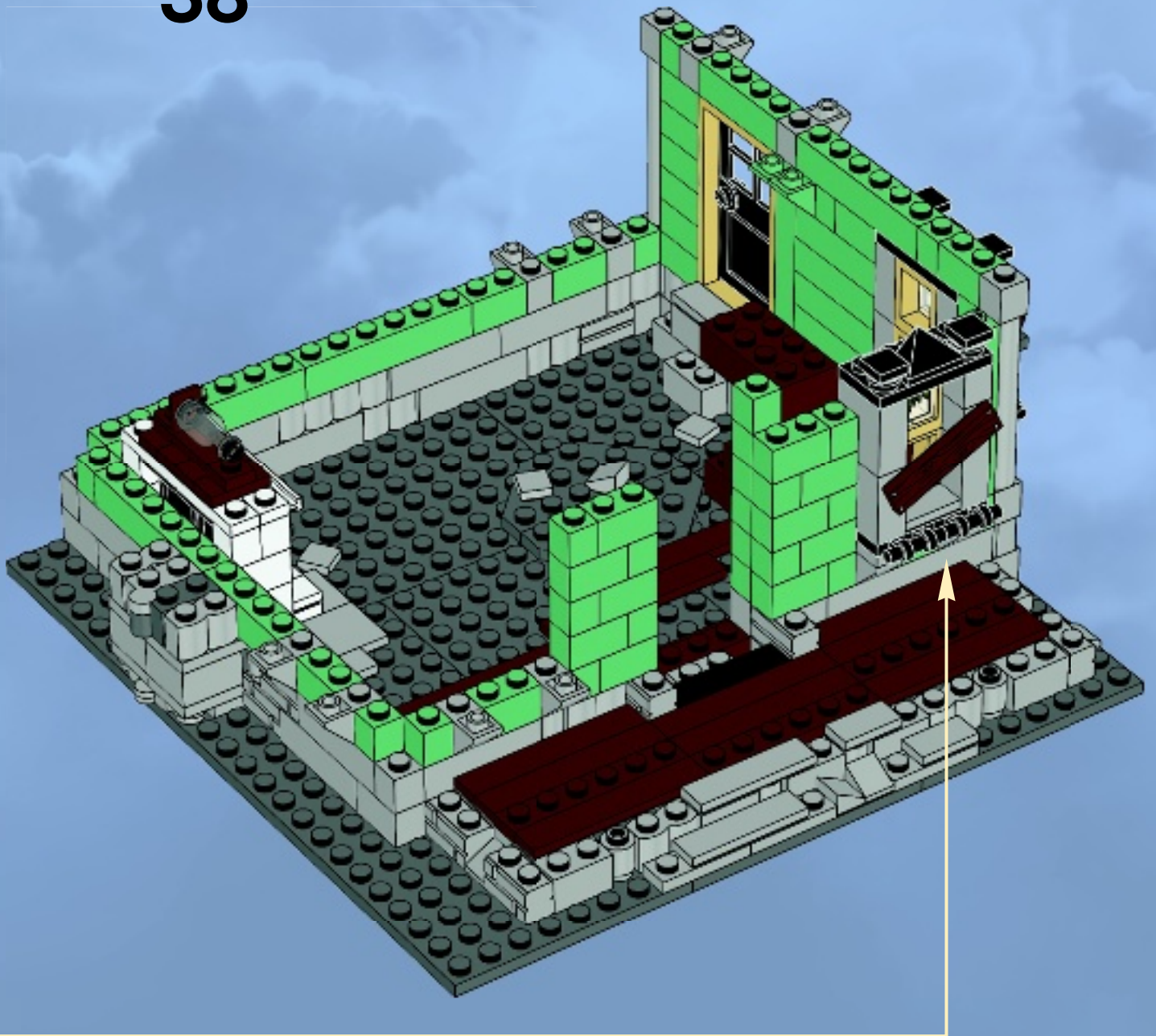

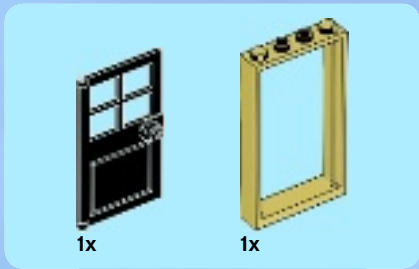

39

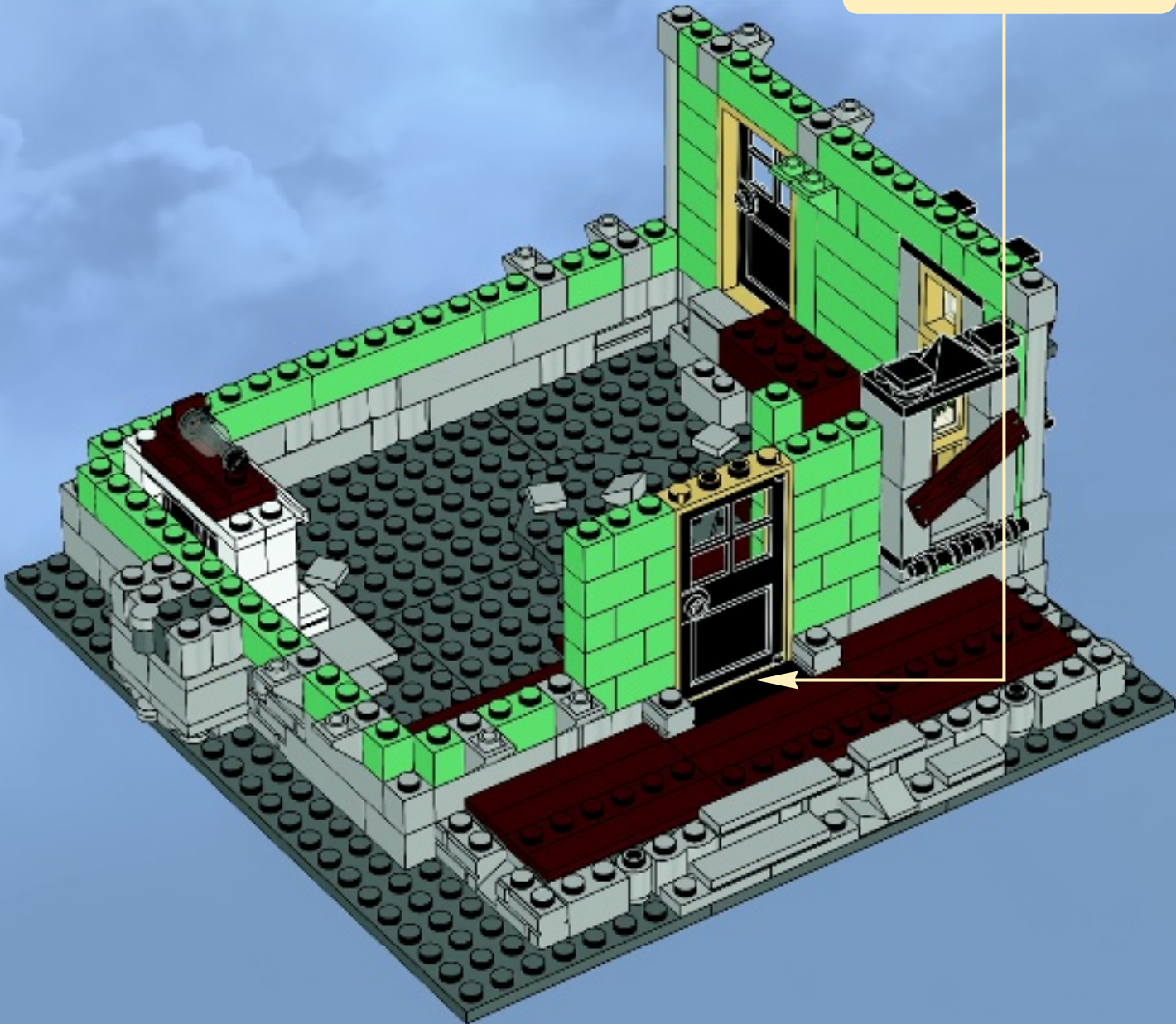
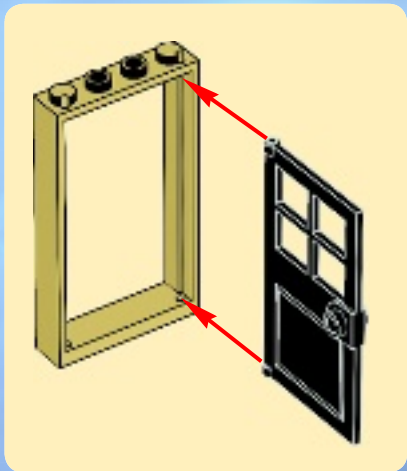

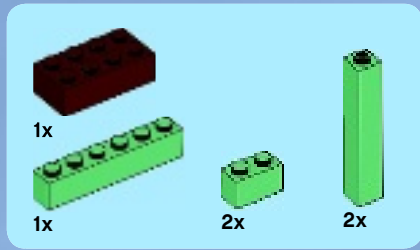

40

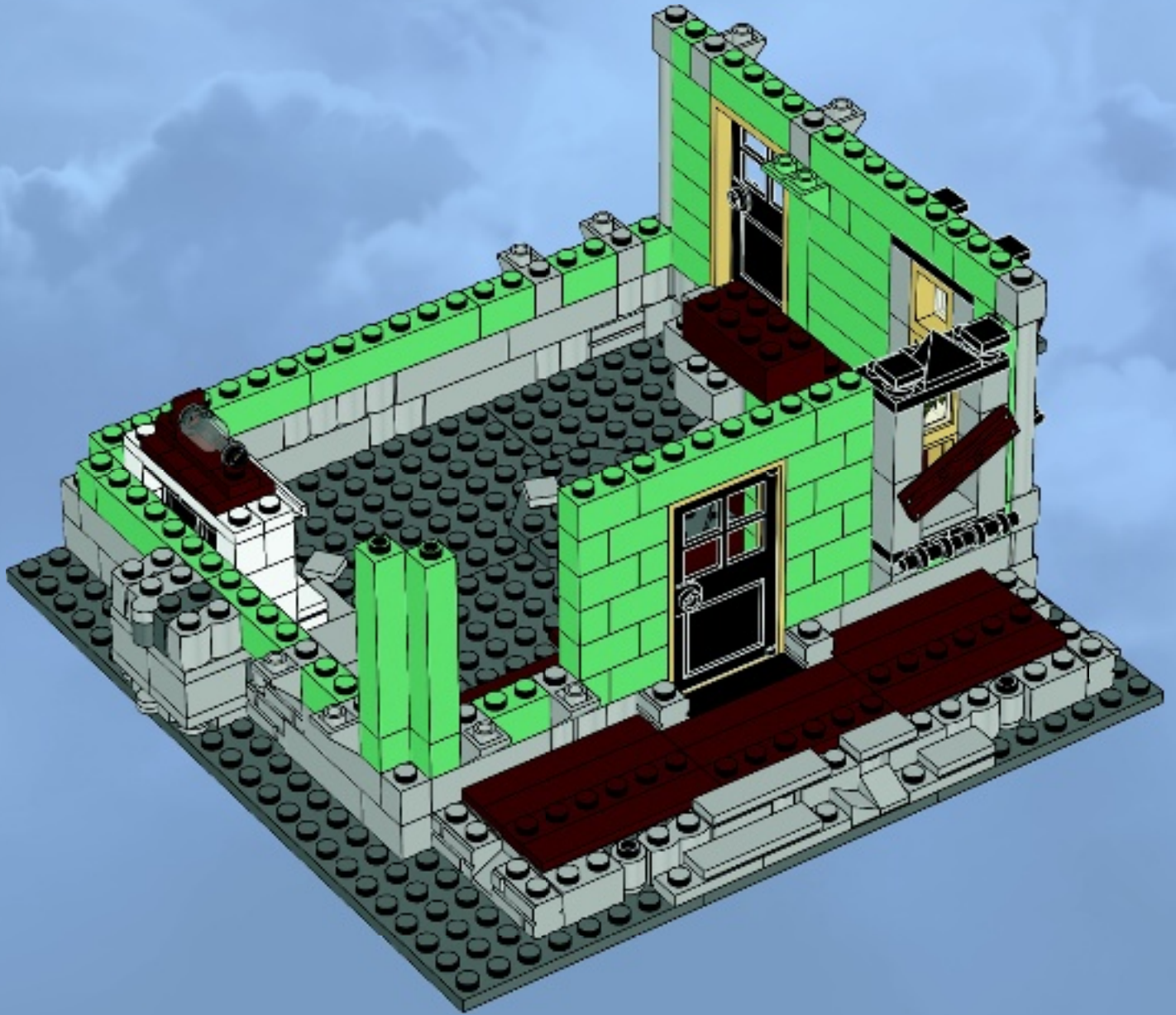



1x

1

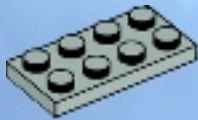

1x



2x

2



1x



2x

3



1x



1x



1x

4

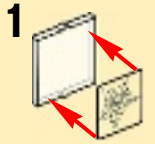
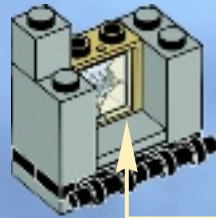

1x



1x



1x

5

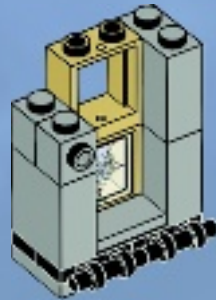

1x



1x

6

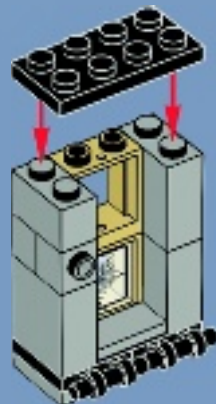



1x



2x

7



2x



1x

8



41

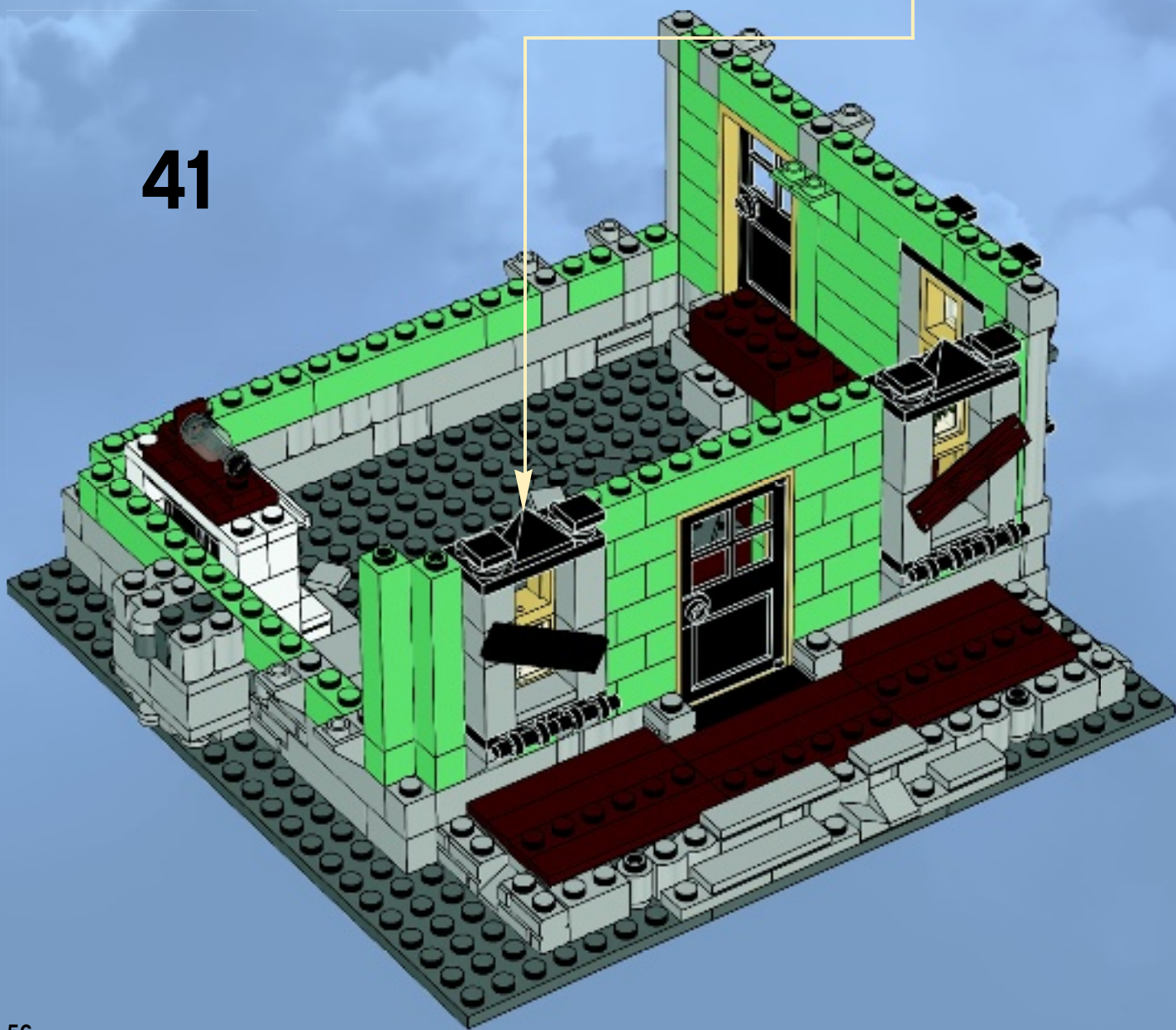

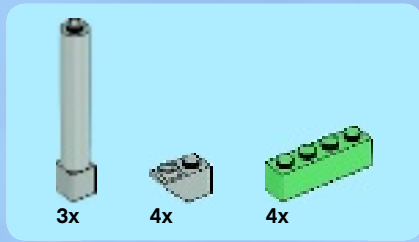

42

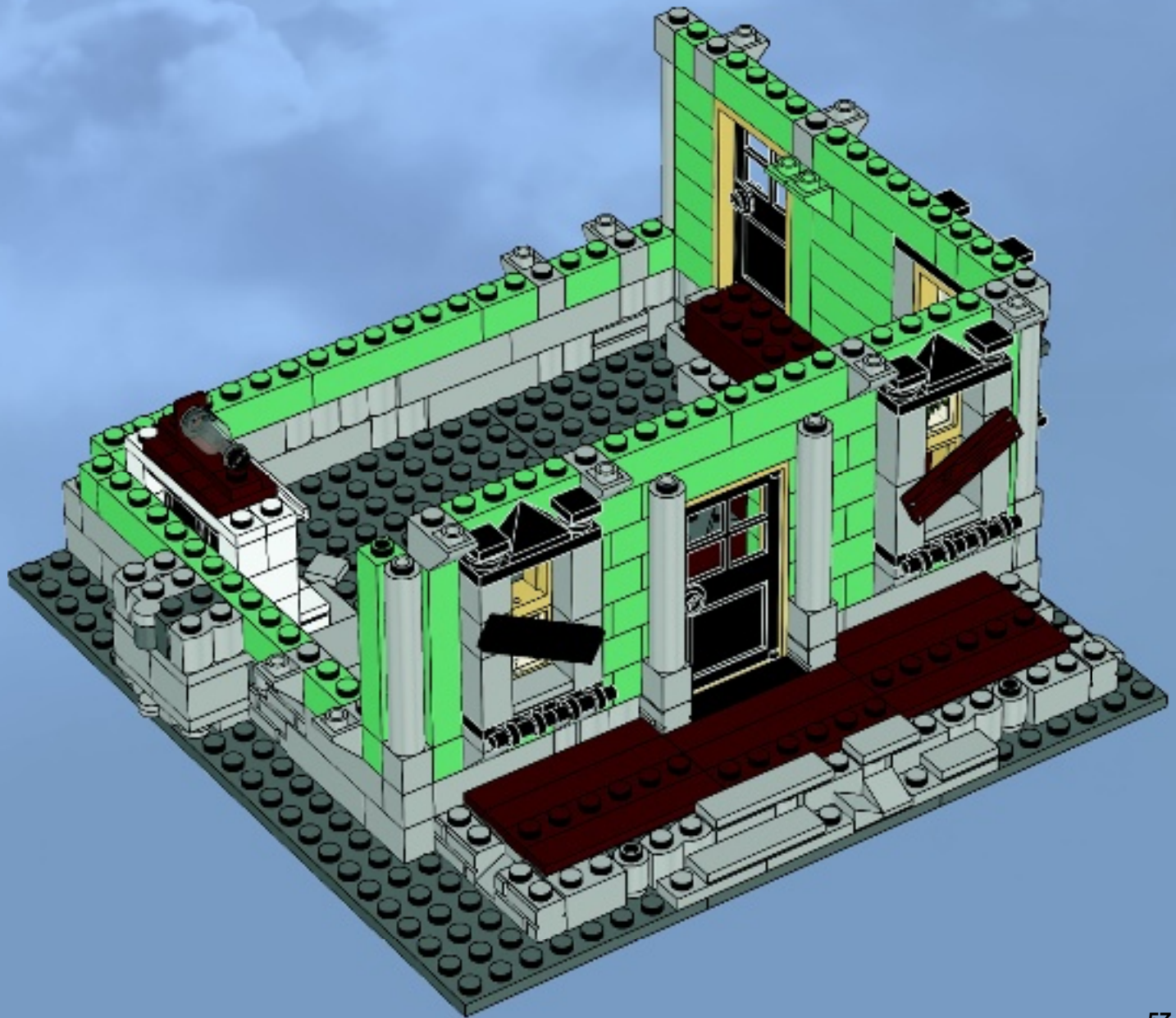



1x

1

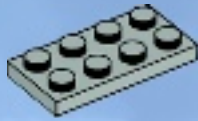

1x



2x

2



1x



2x

3



1x



1x



1x

4

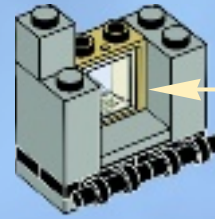

1

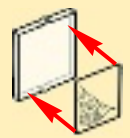

2



1x



1x



1x

5

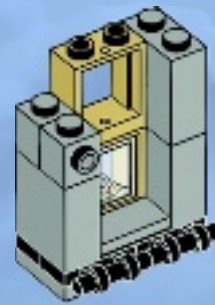

1x



1x

6

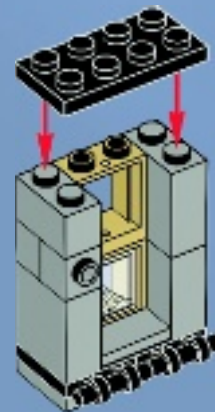



1x



2x

7



2x



1x

8



43

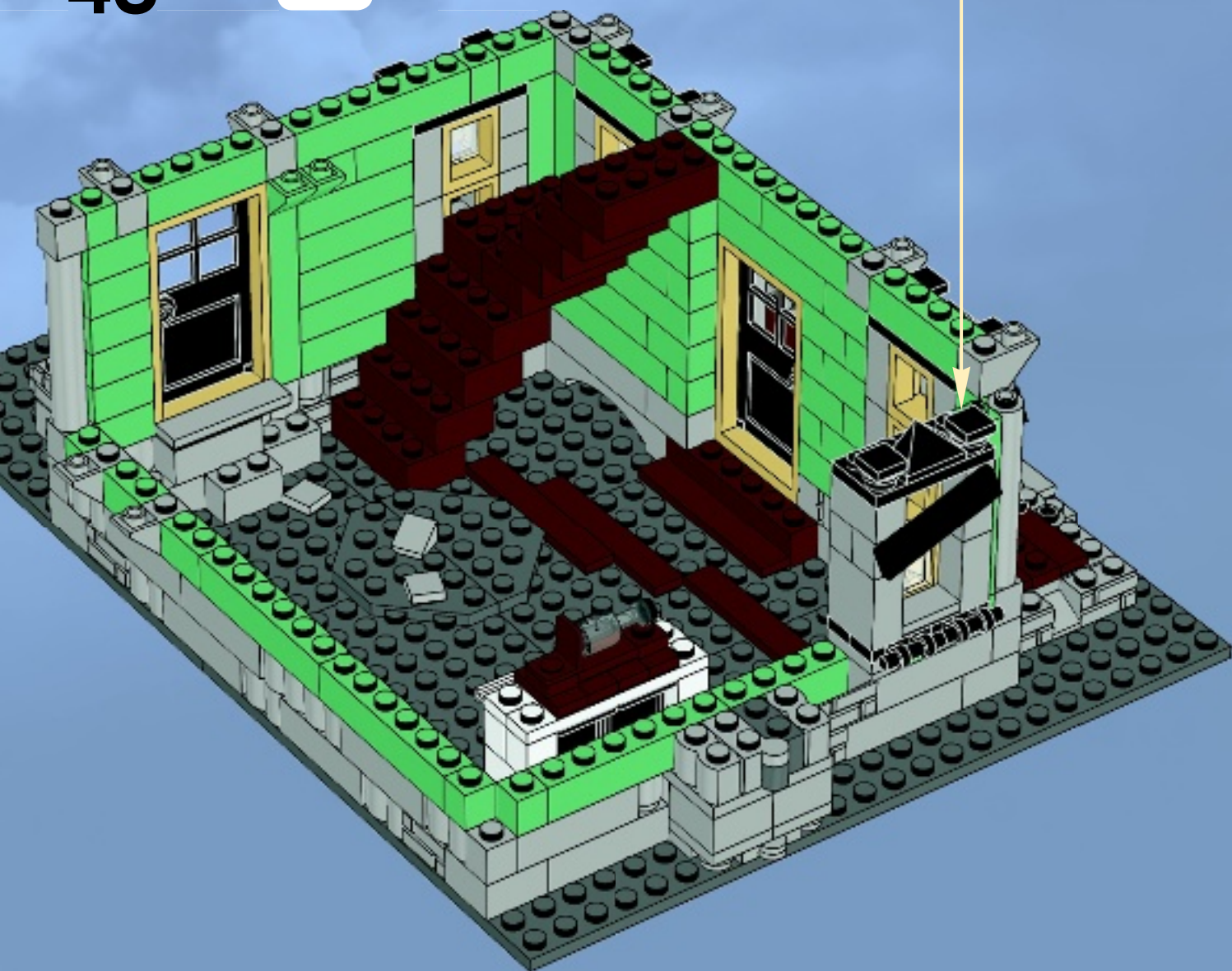

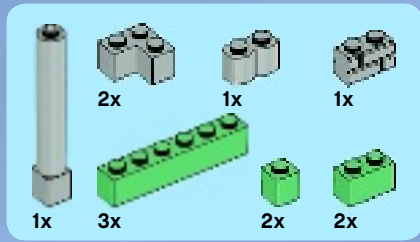

44

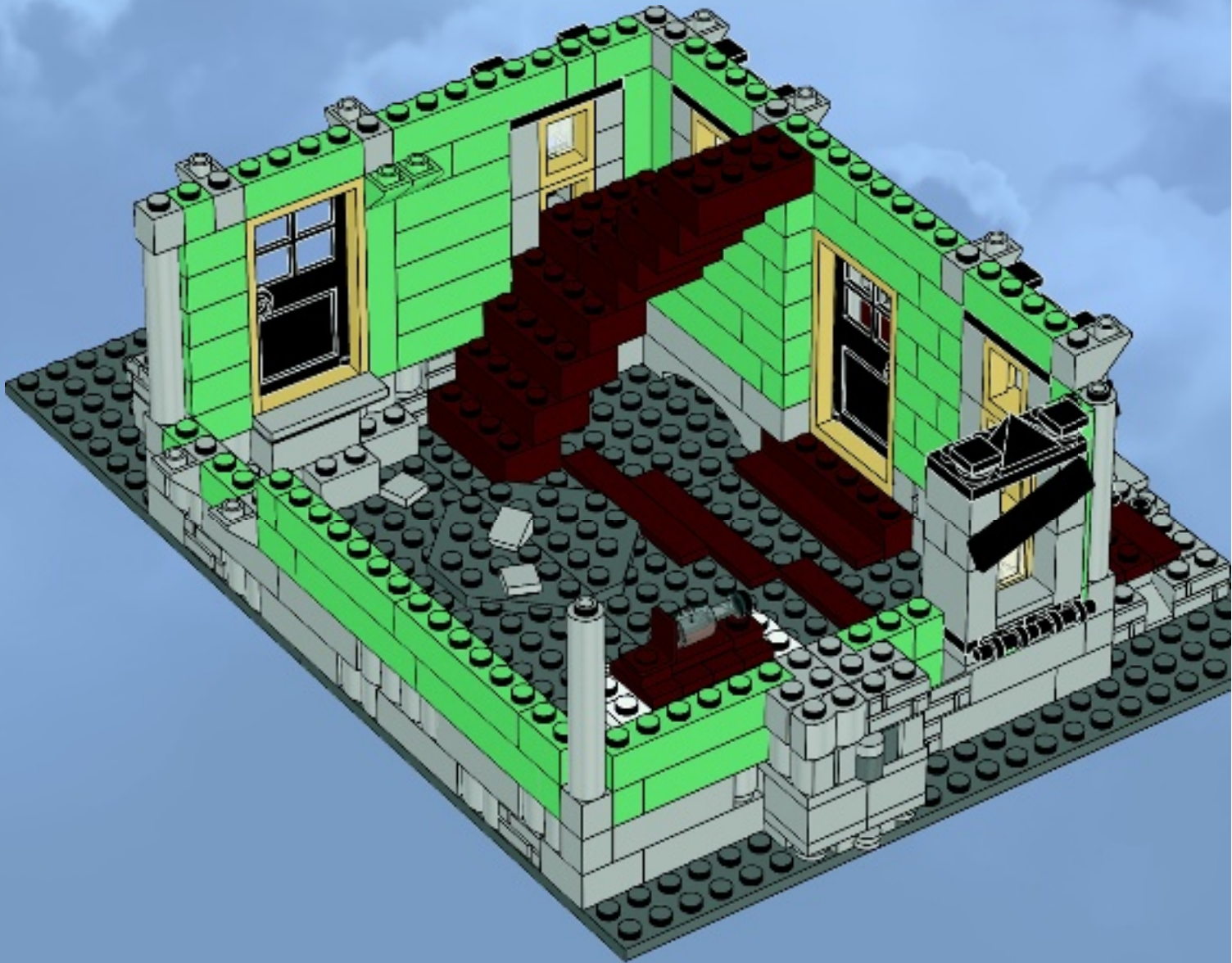

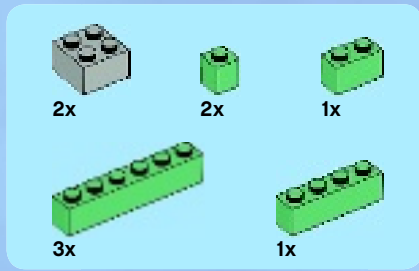

45

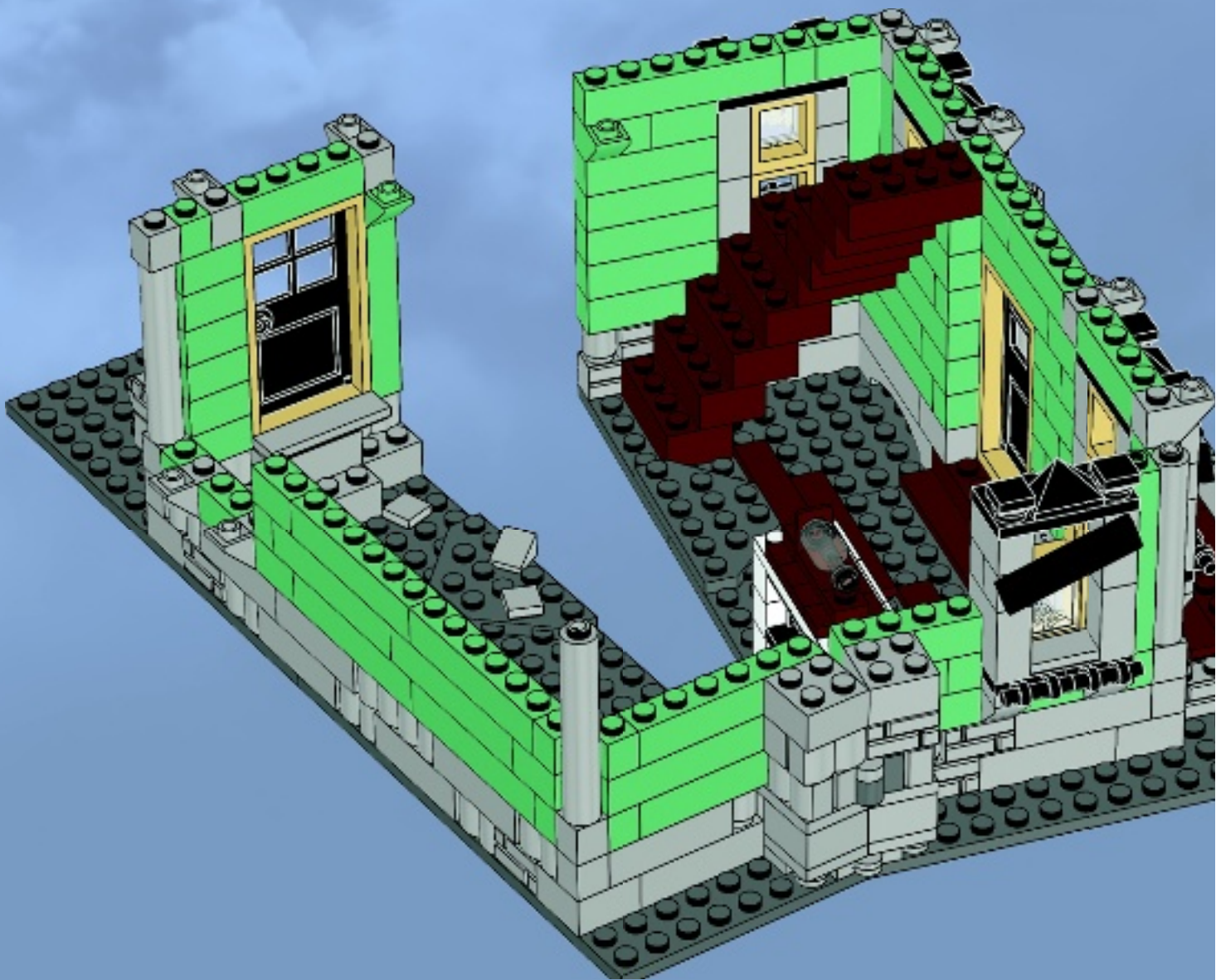

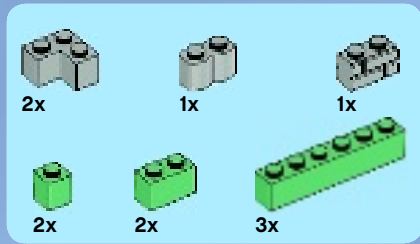

46

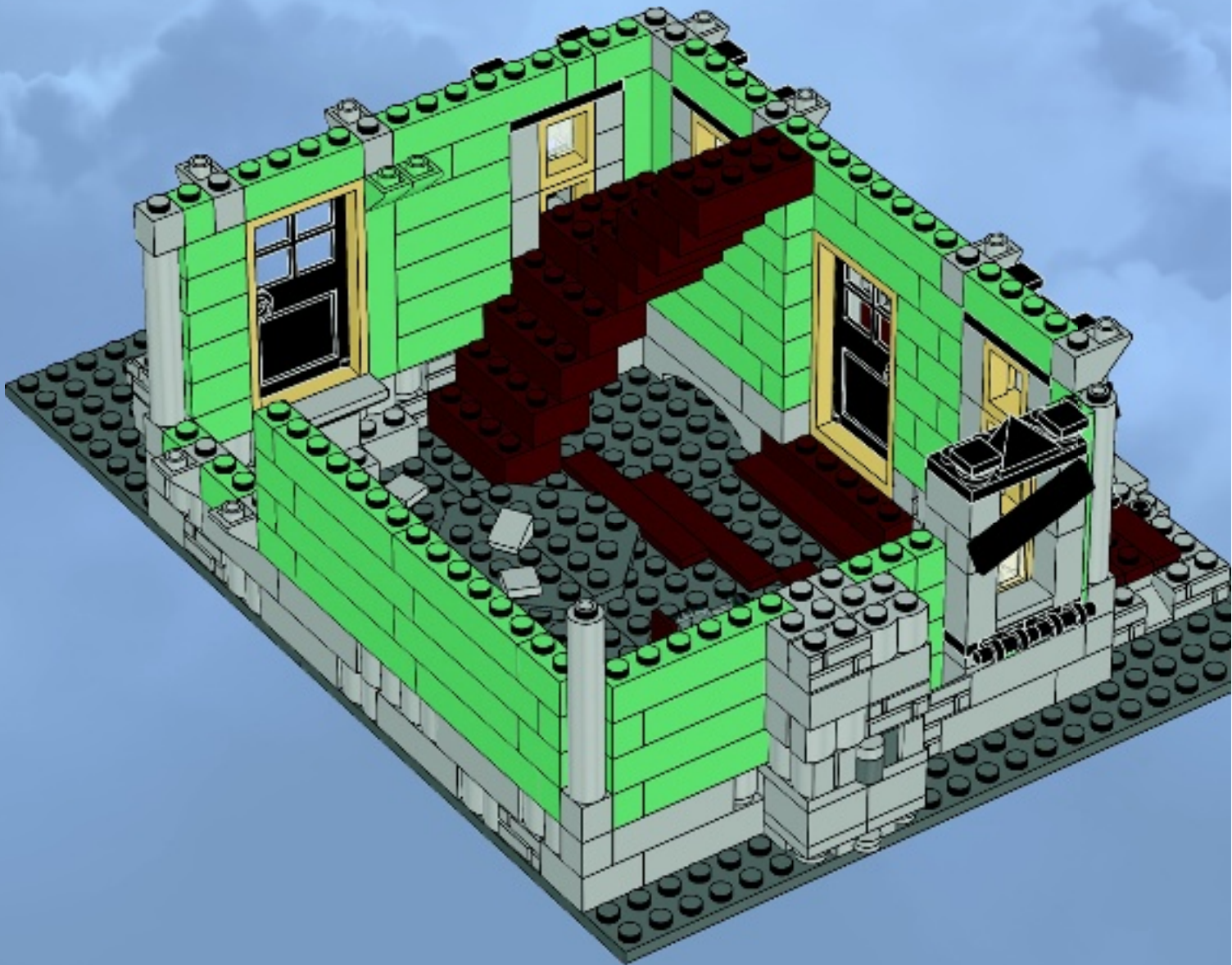

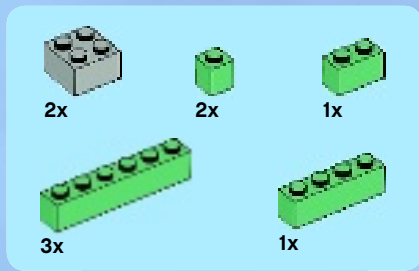

47

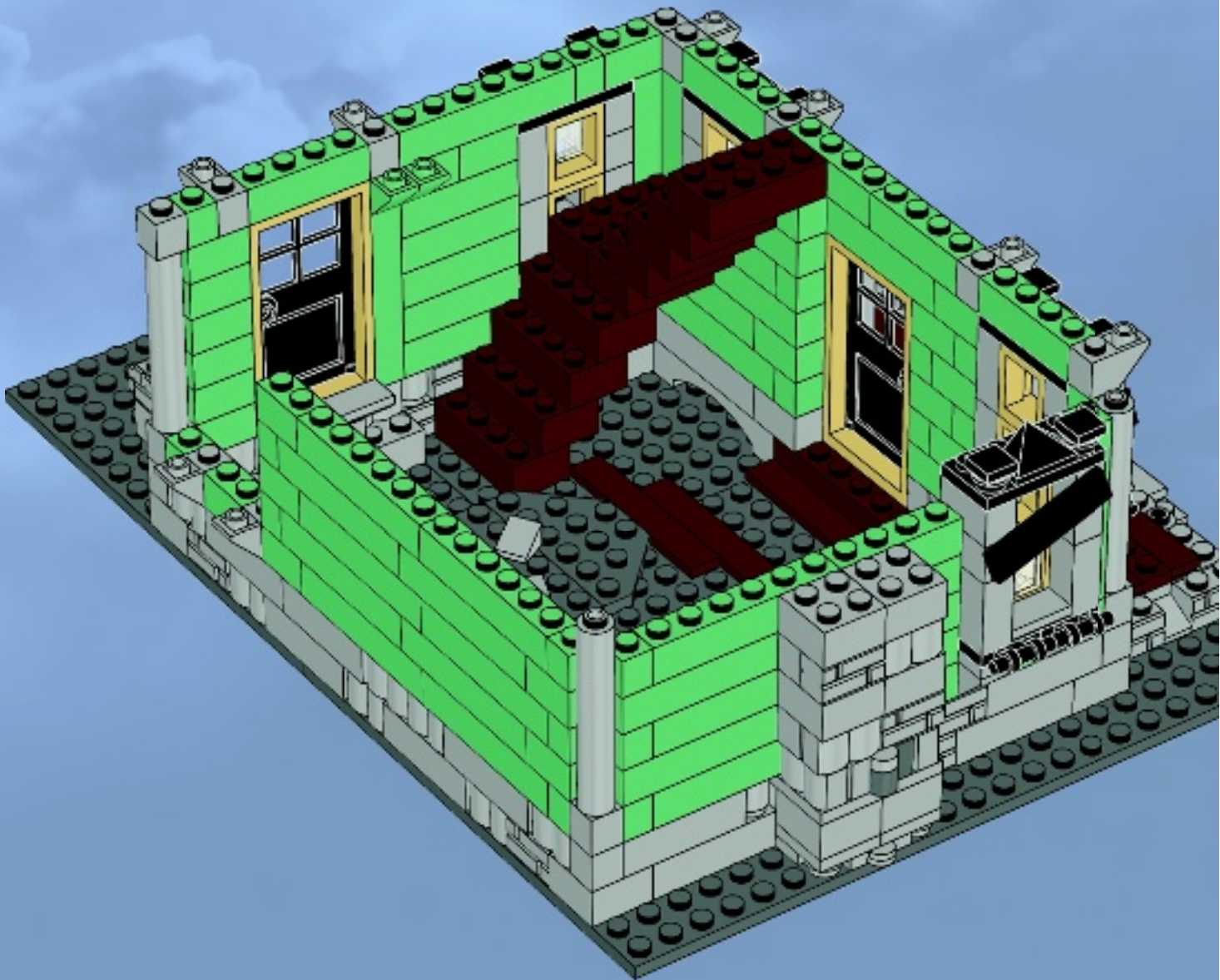

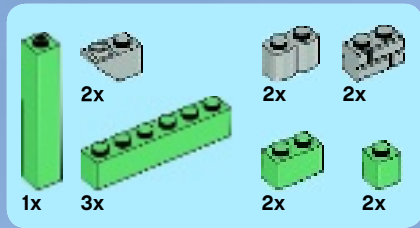

48

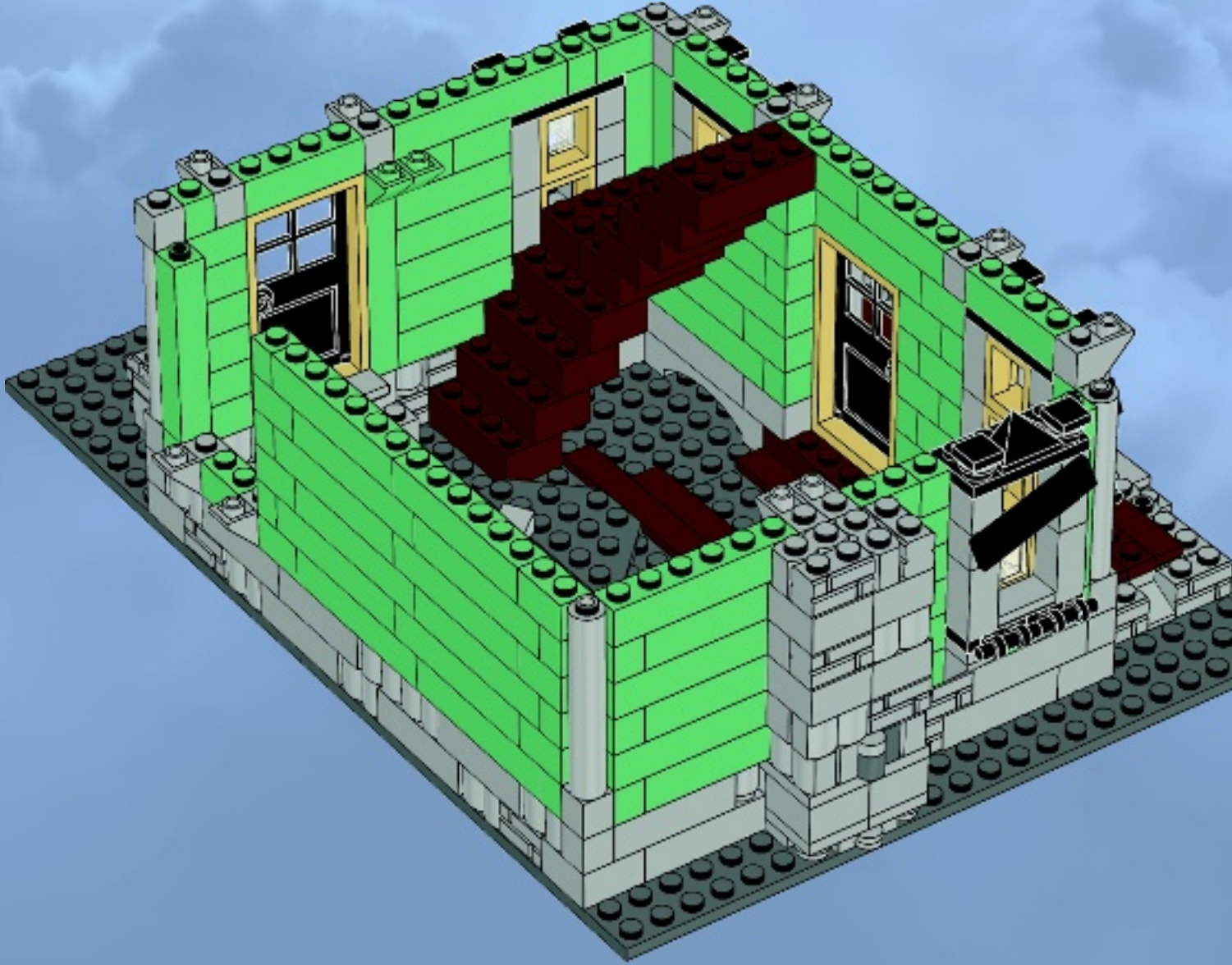

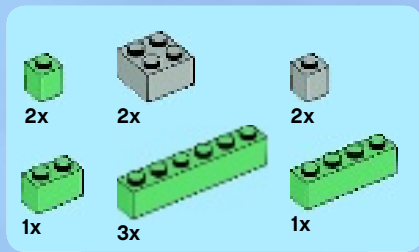

49

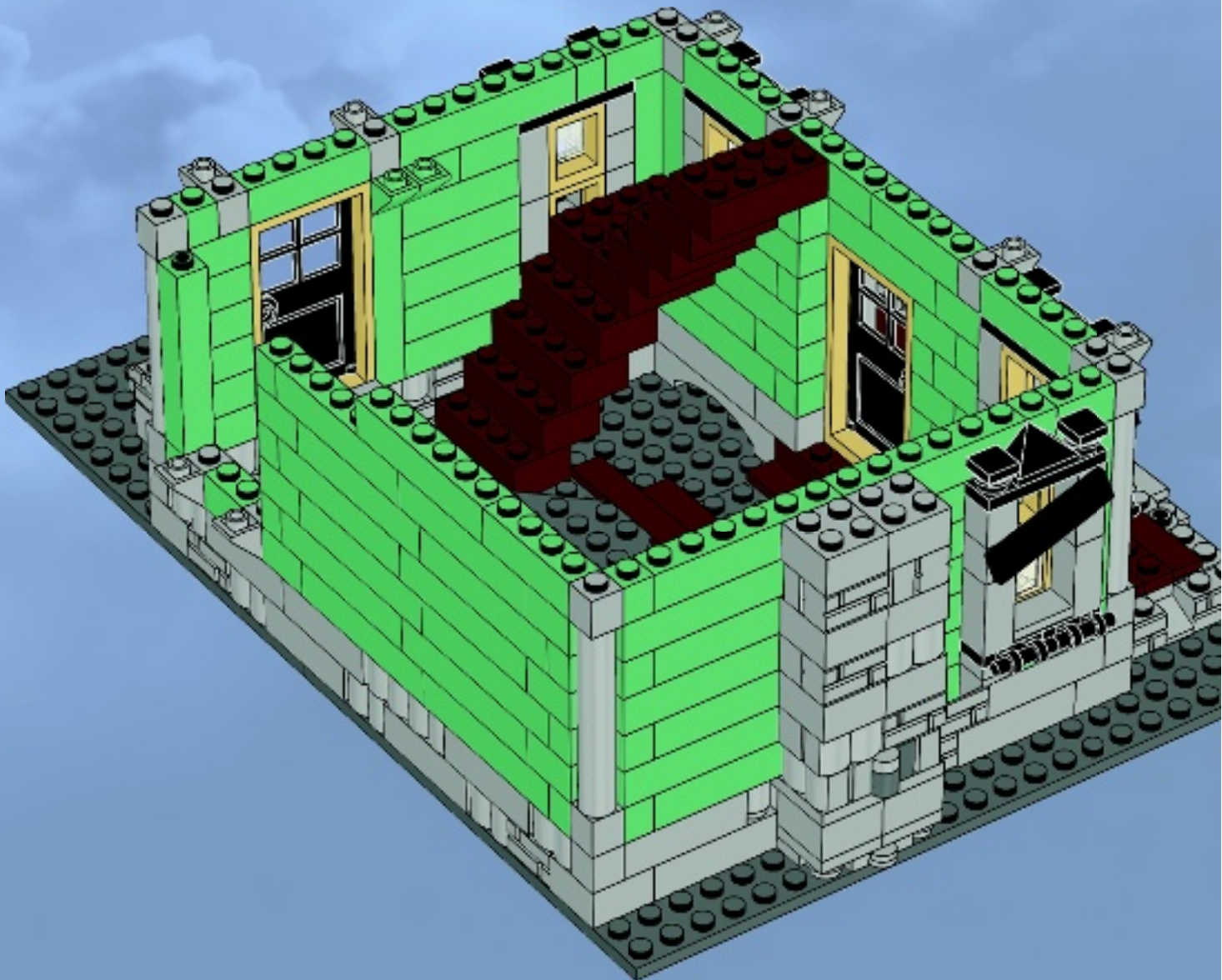



1x

1

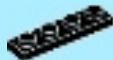

1x



2x

2



1x



2x



1x

3



2x



1x

4

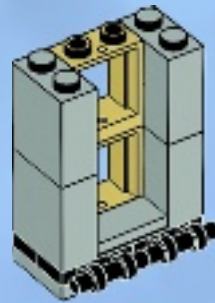

1x

5



1x



2x

6

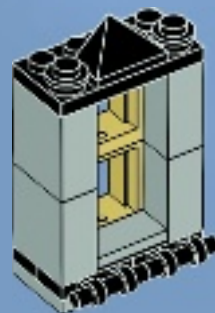

2x

7

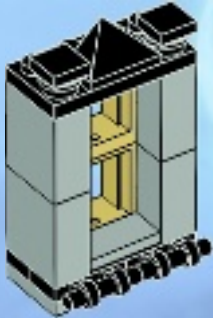

50

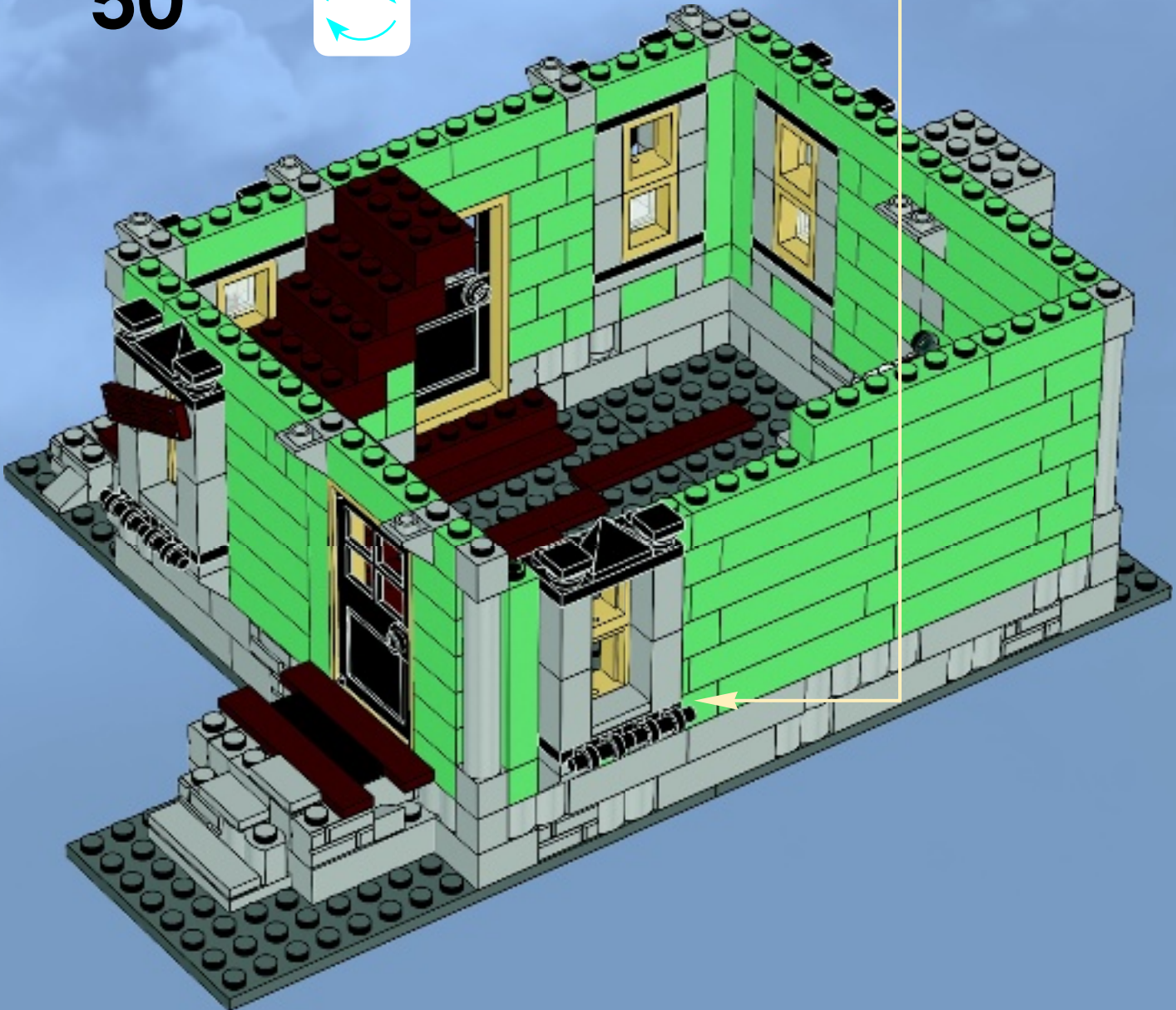



1x



1x

51

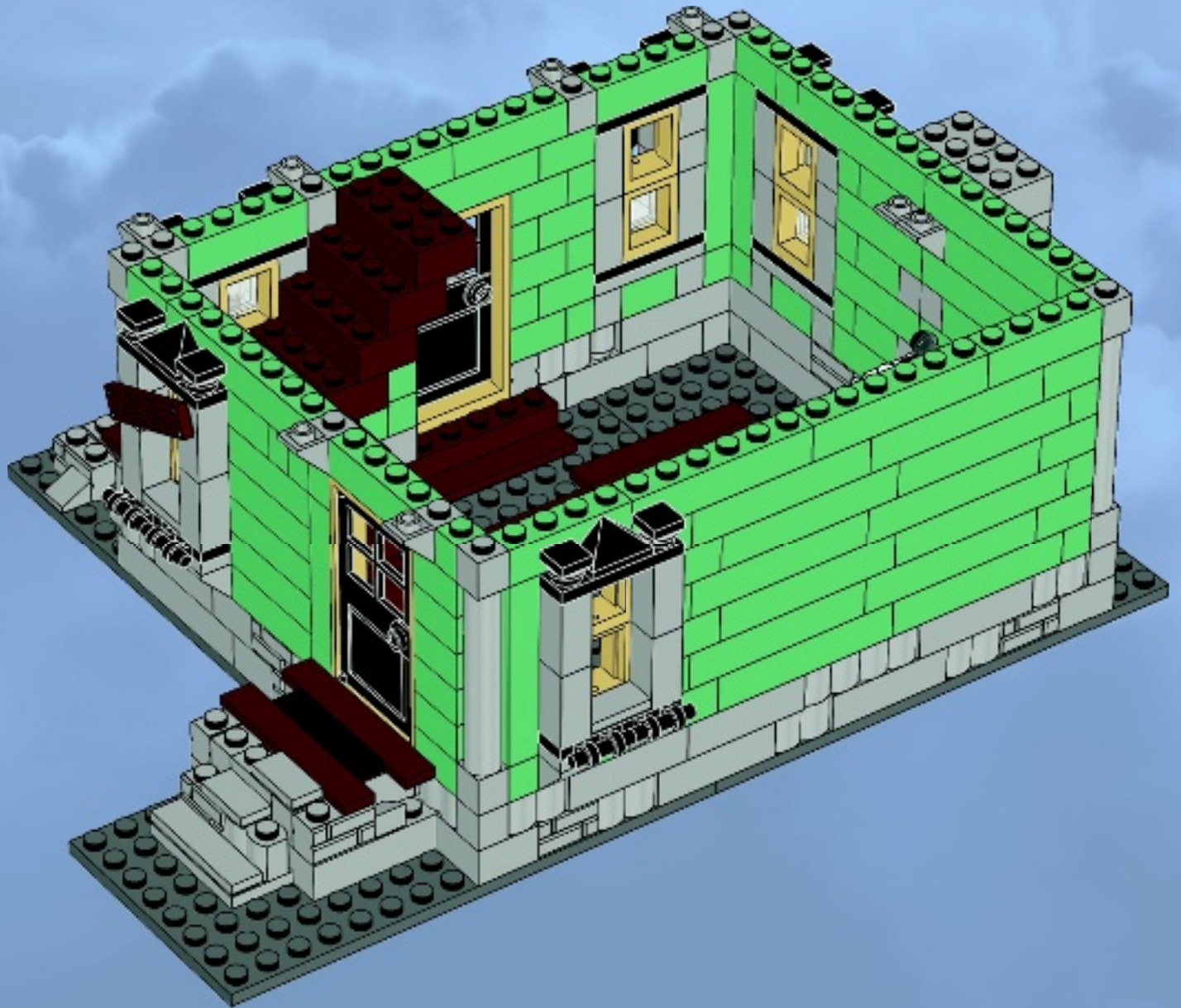

52

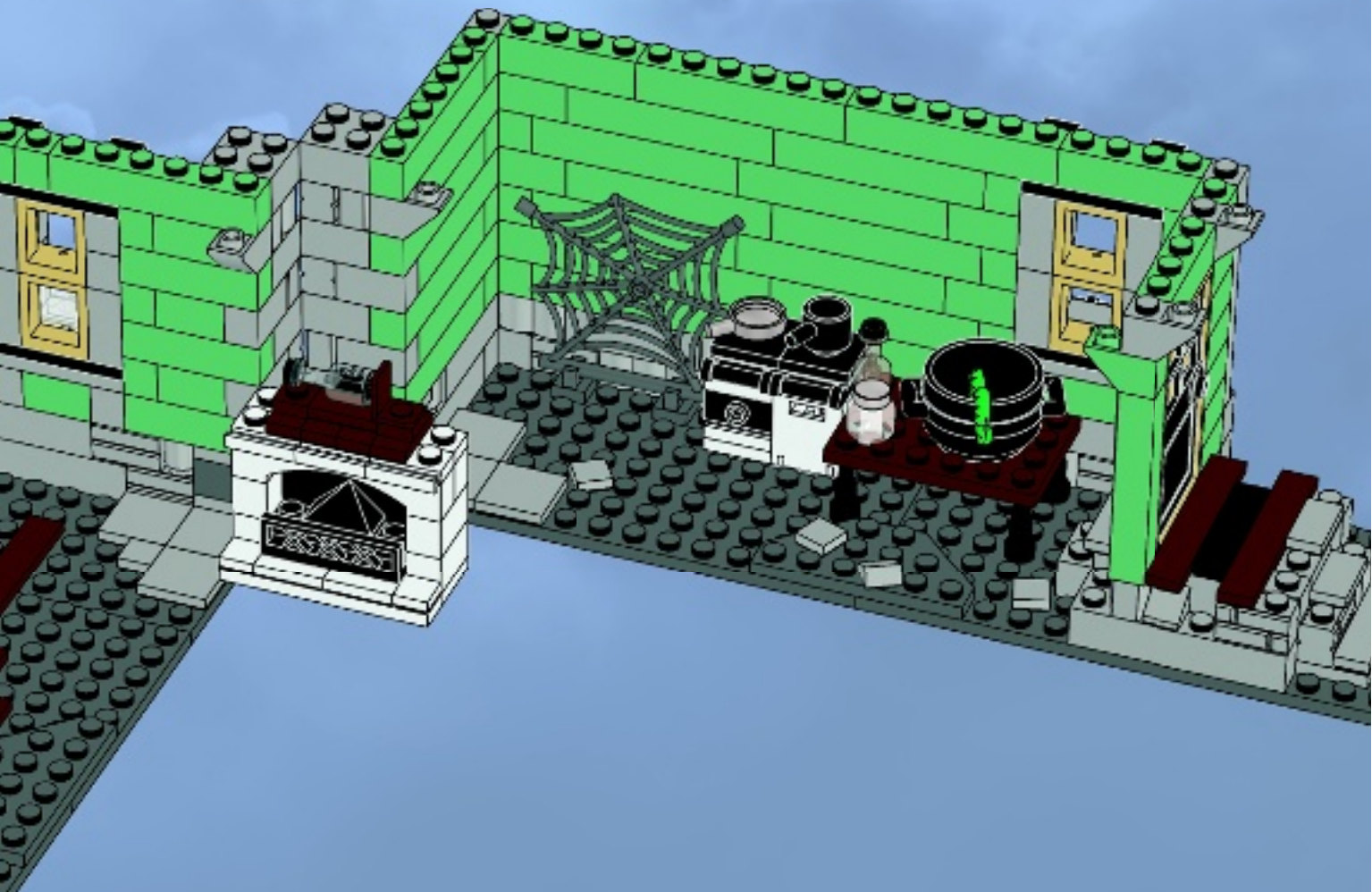

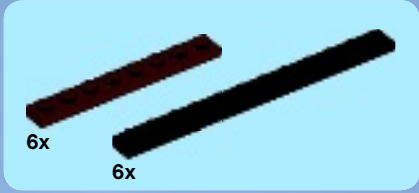

1

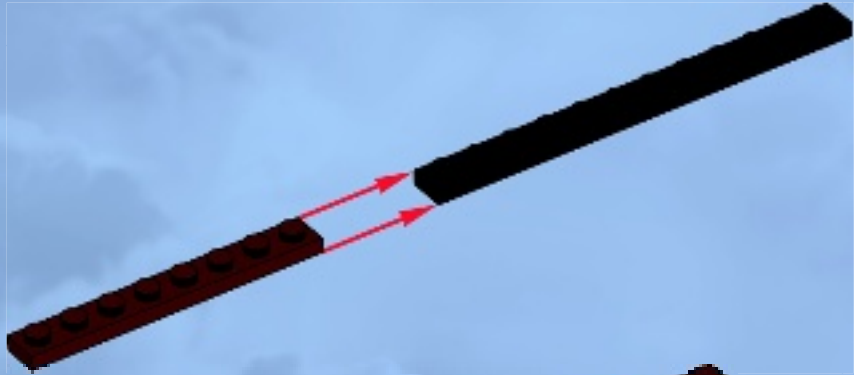

2



3



2x

53

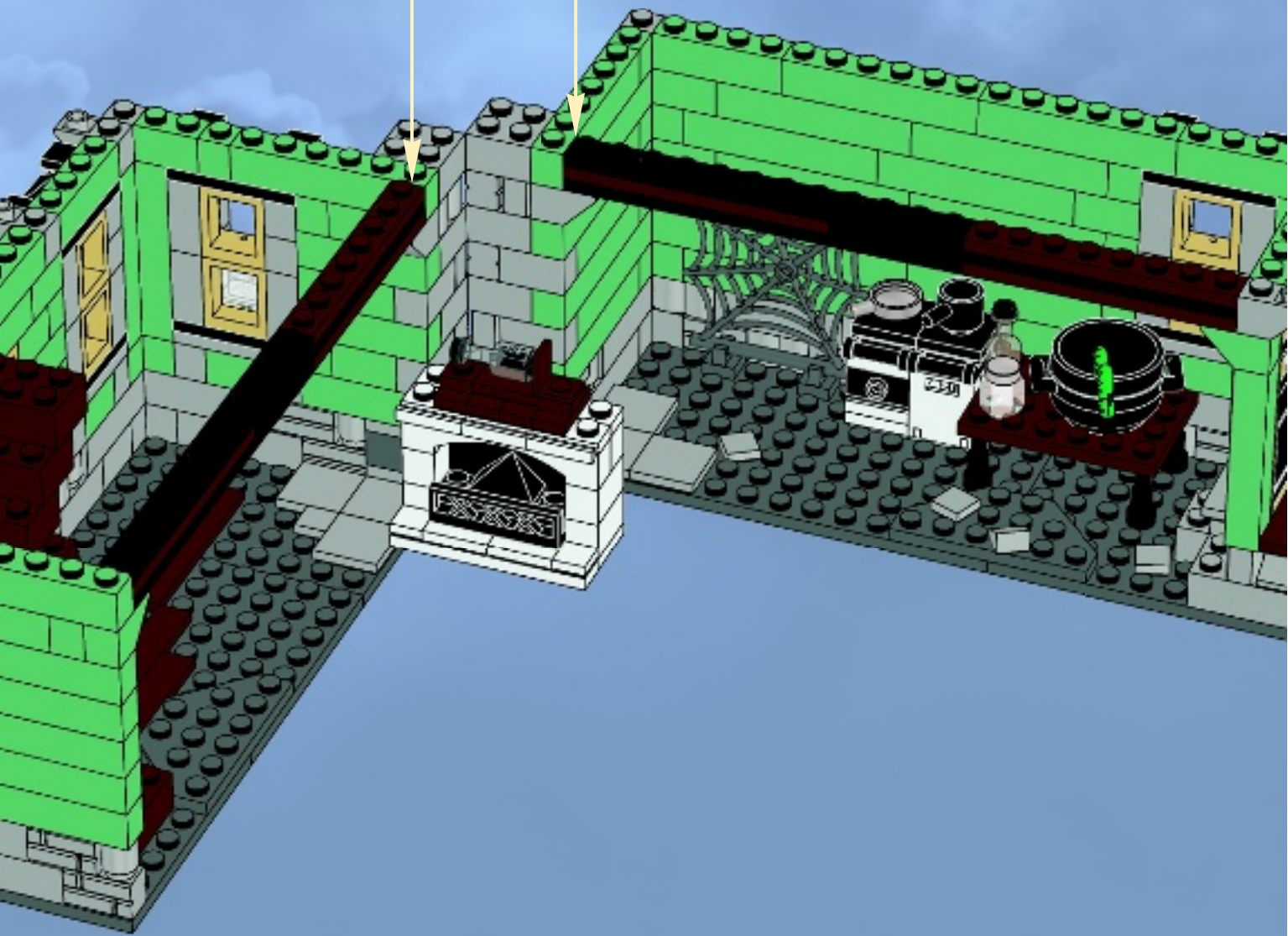

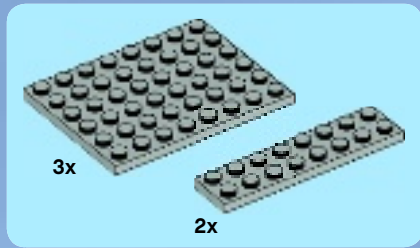

54

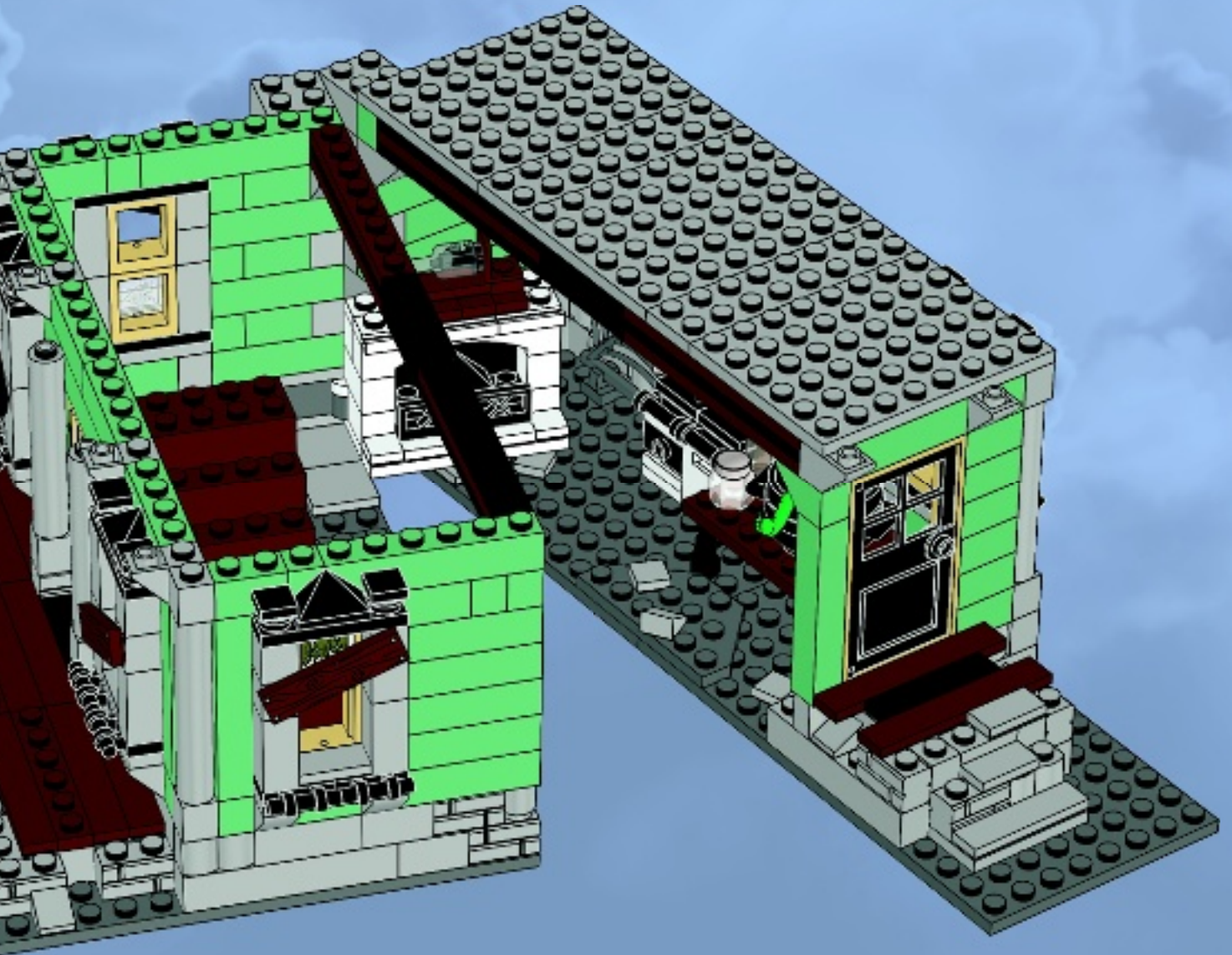

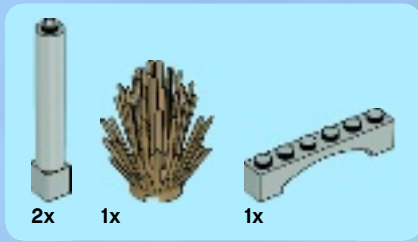

55

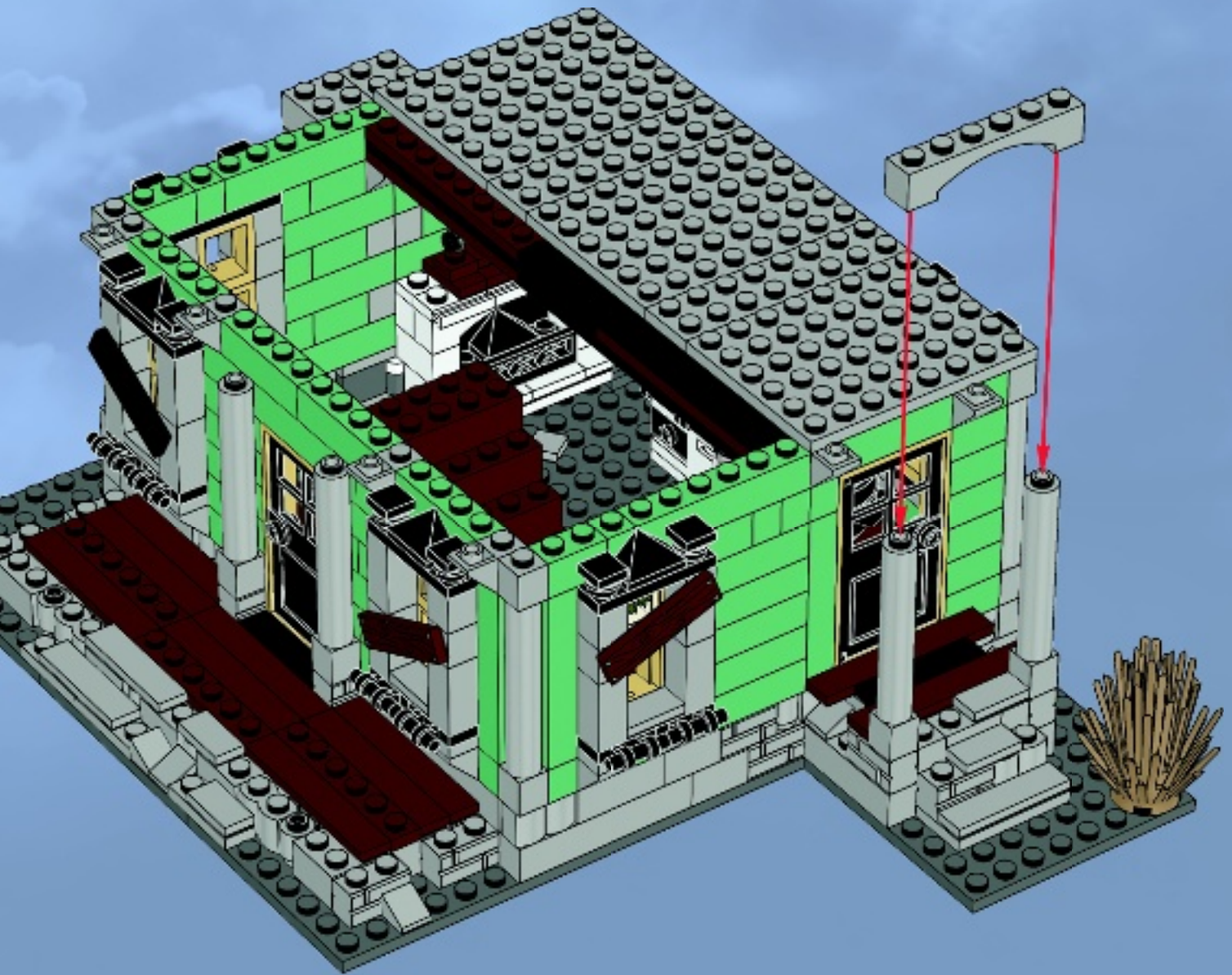

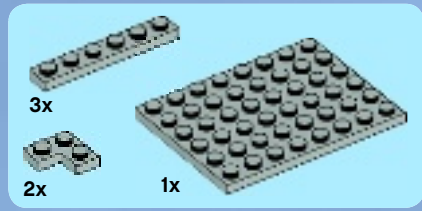

56

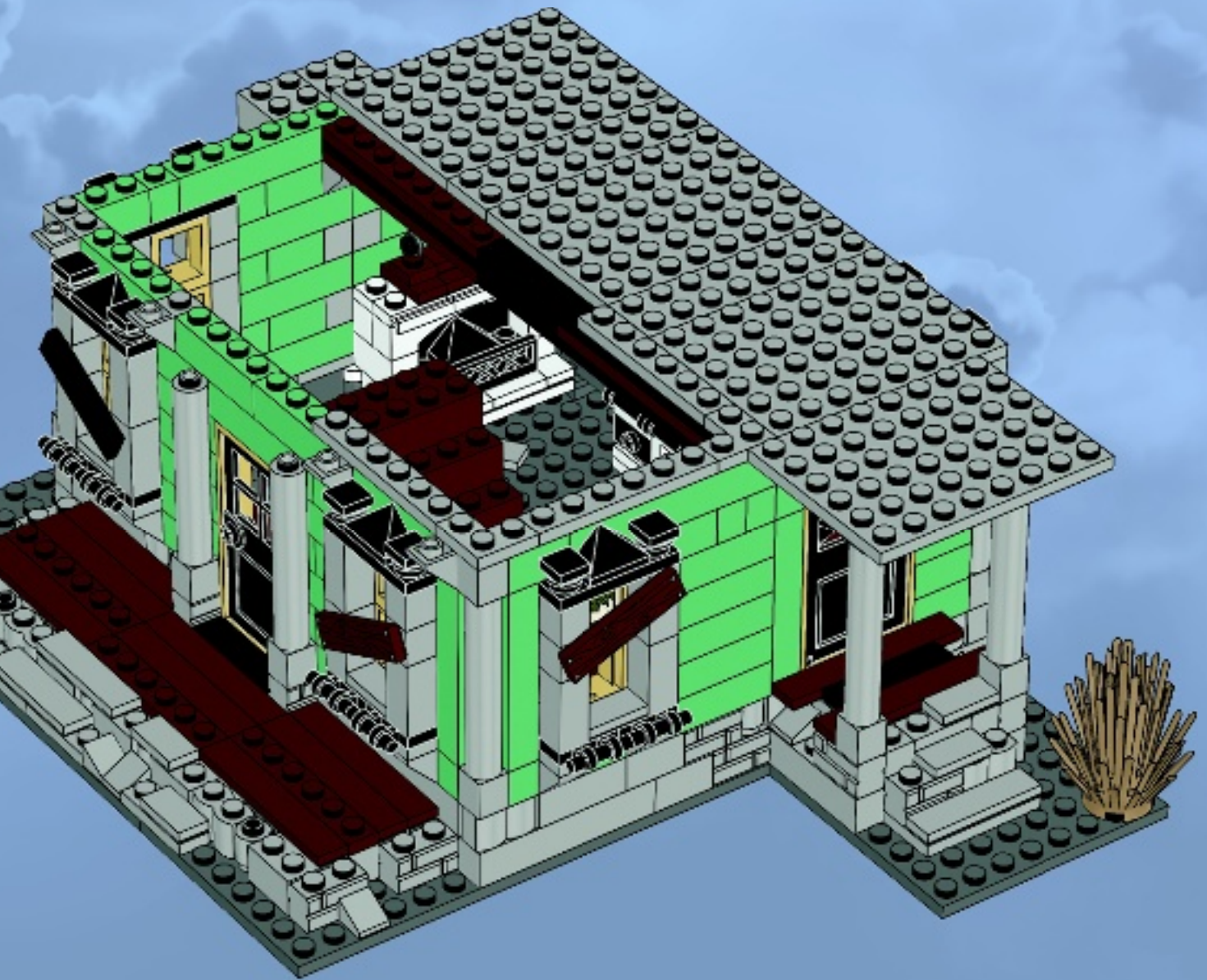

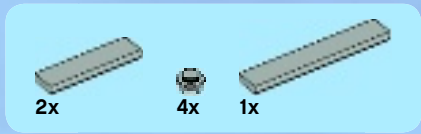

57

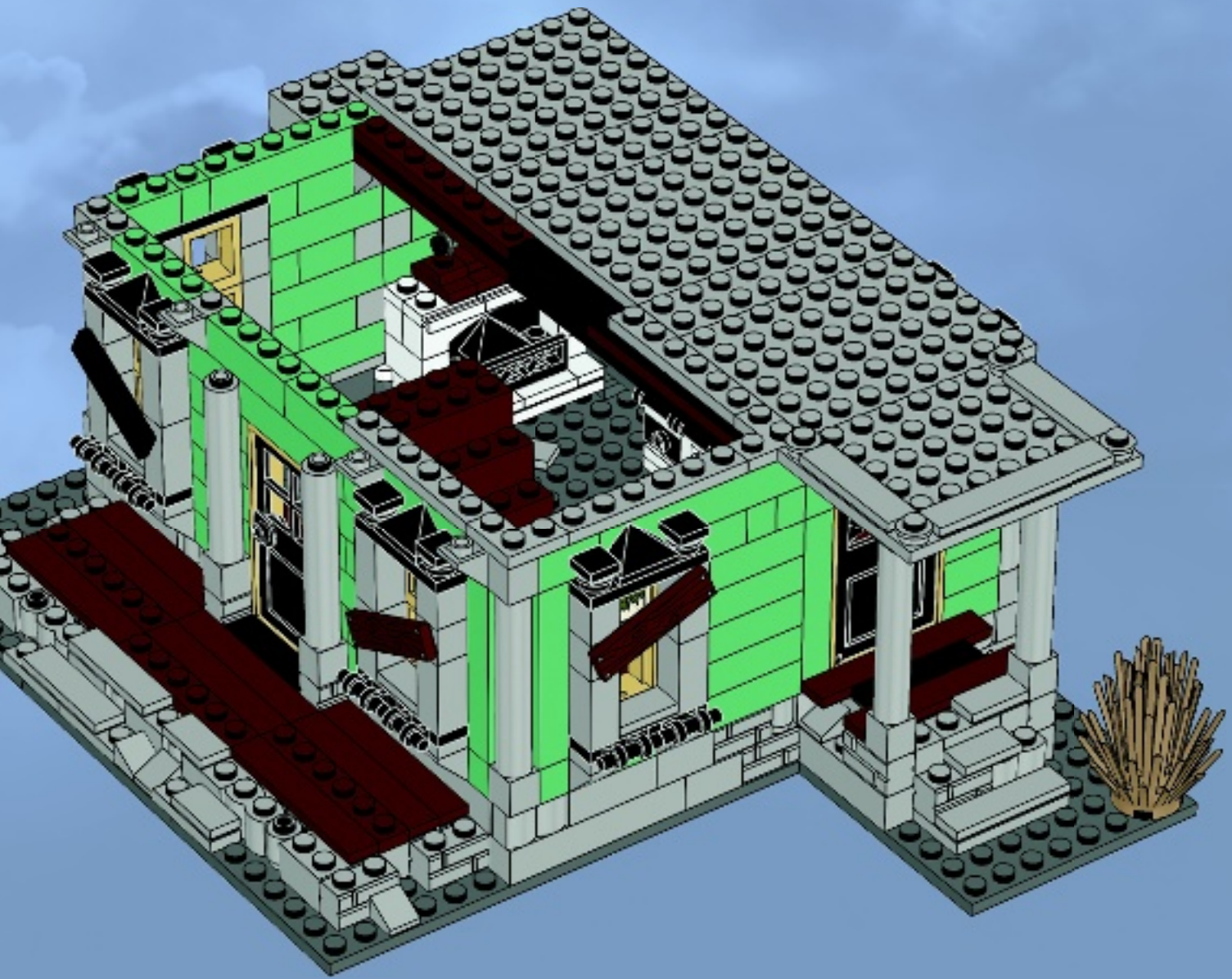

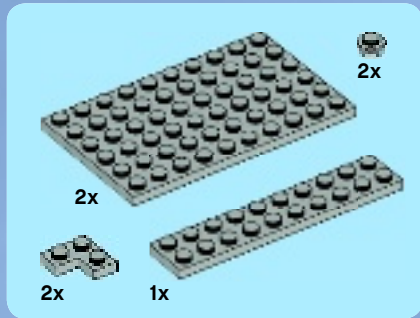

58

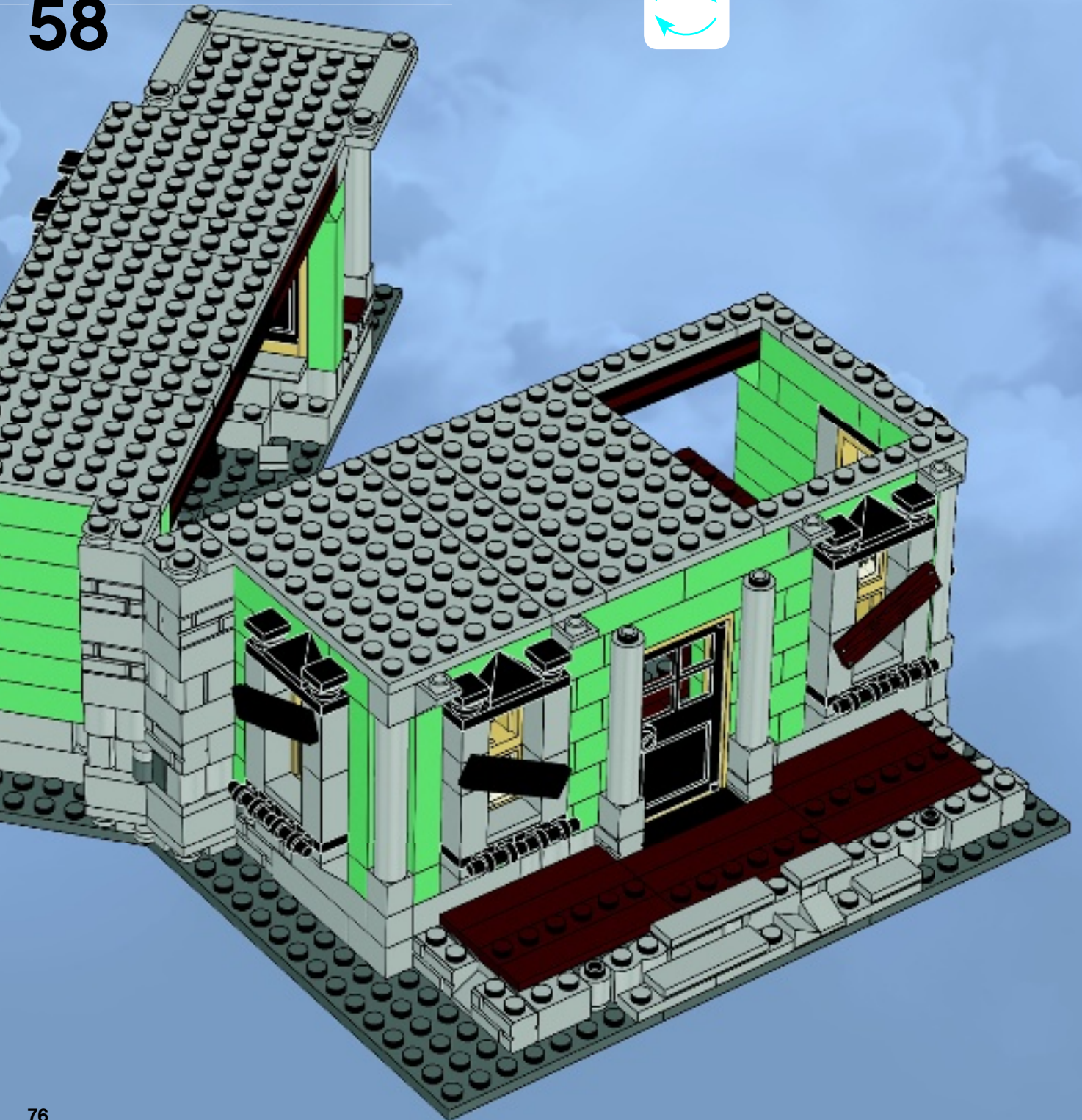



4x



4x

59

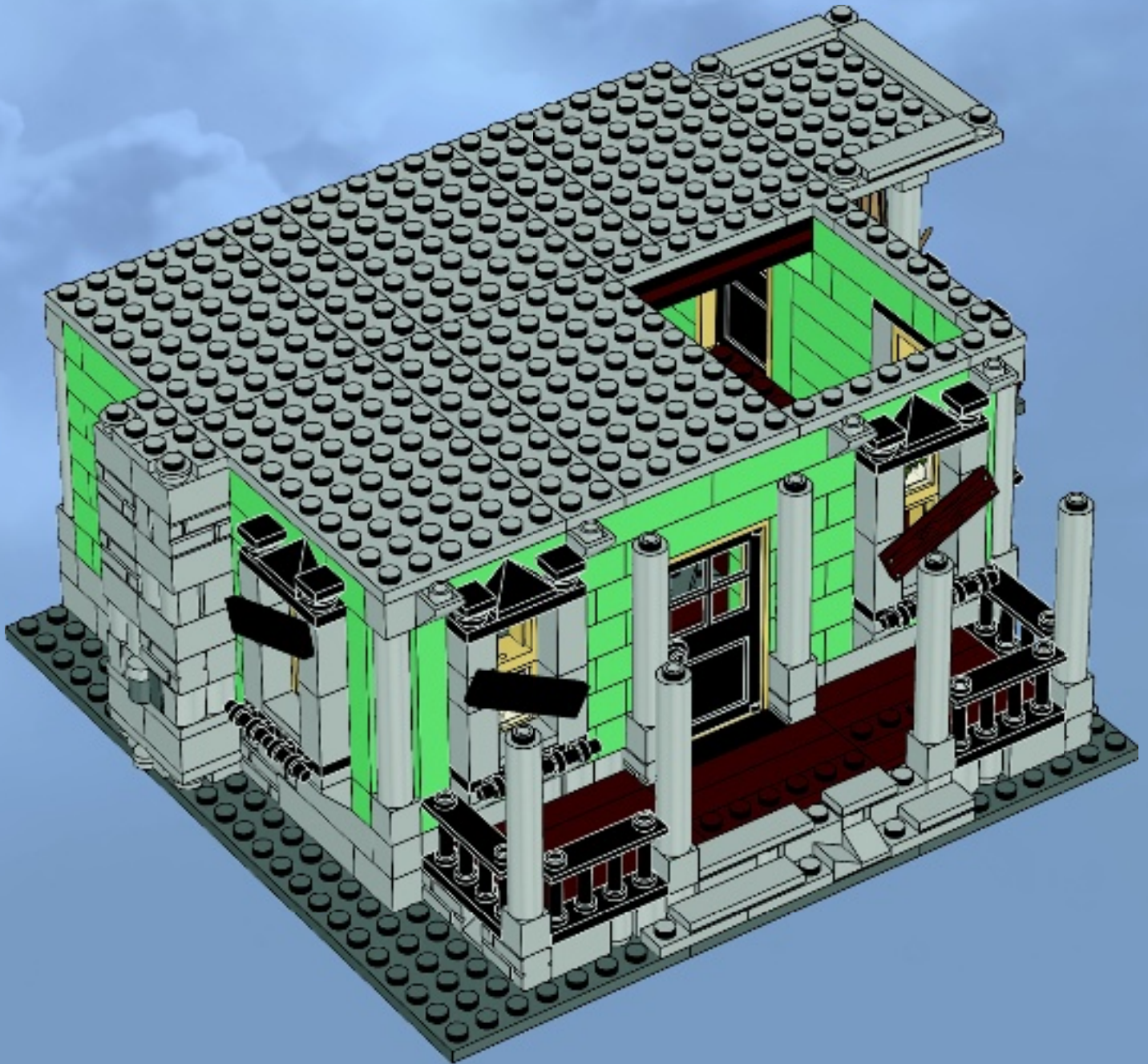

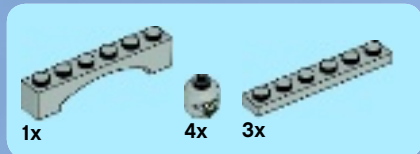

60

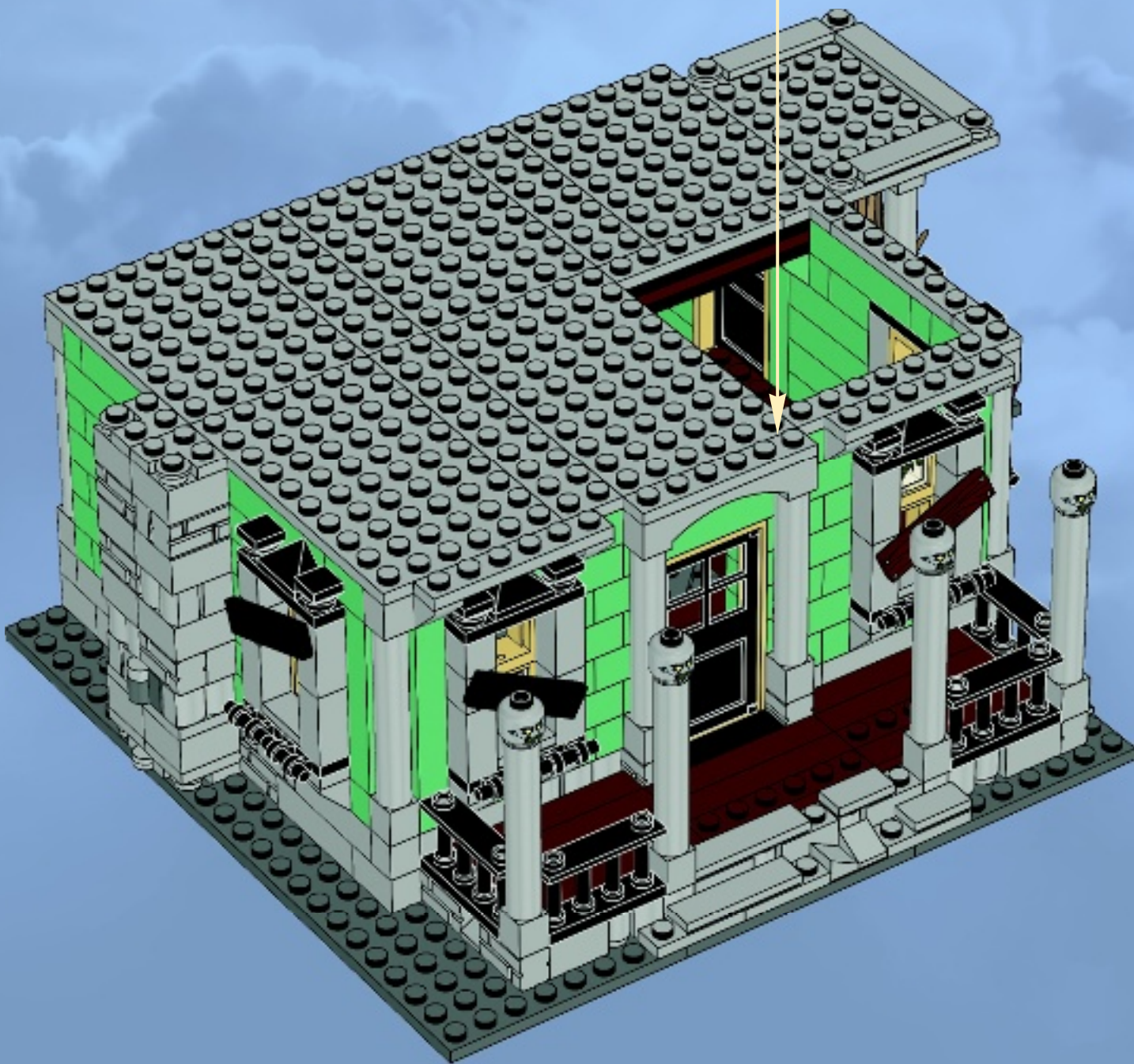
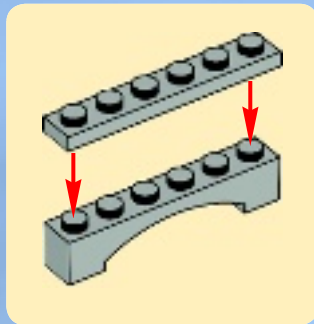



2x



4x



2x



2x

61

1

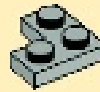

2

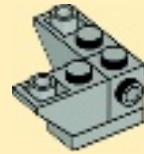

3

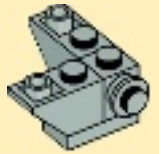

1



2

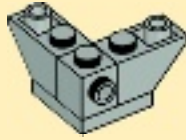

3

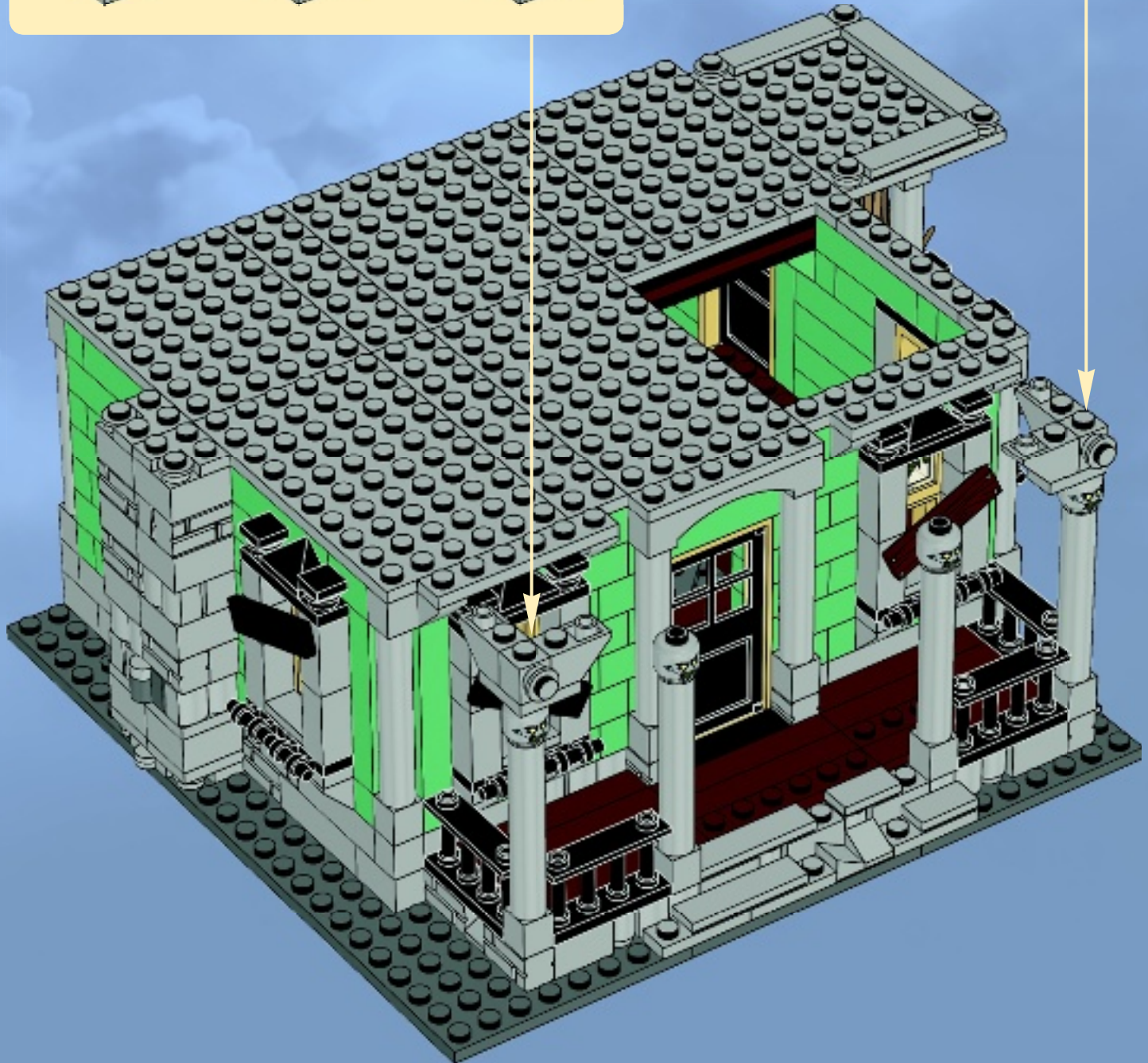
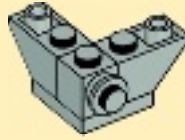

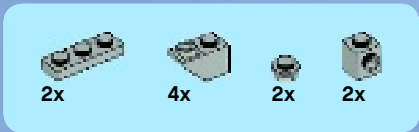

62

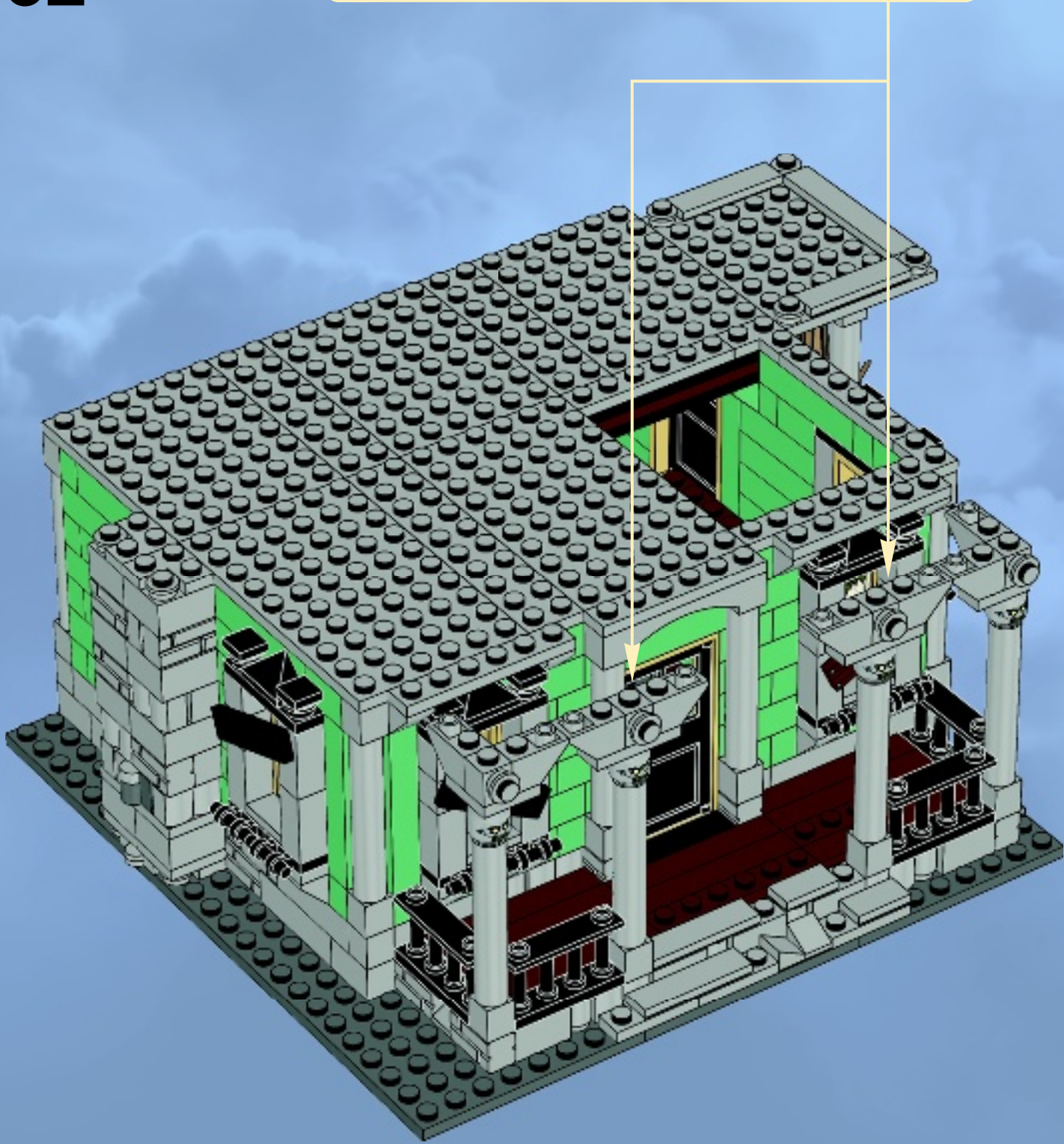
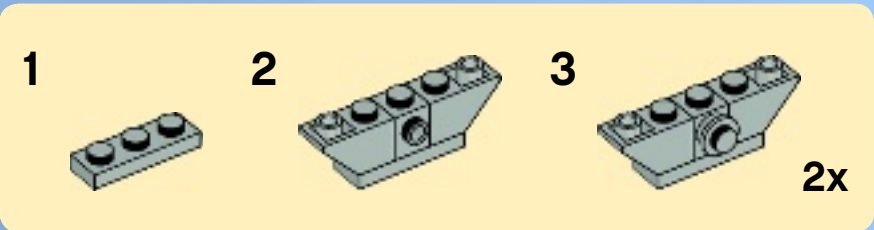

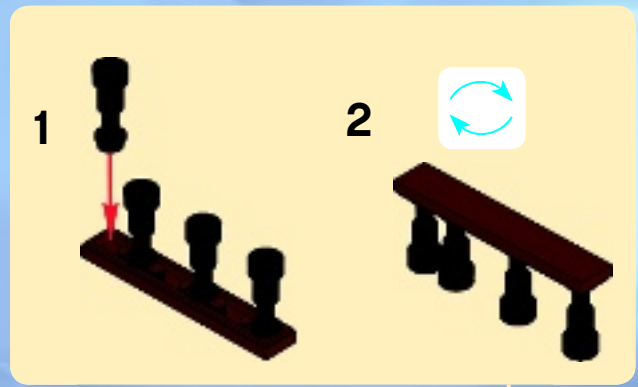
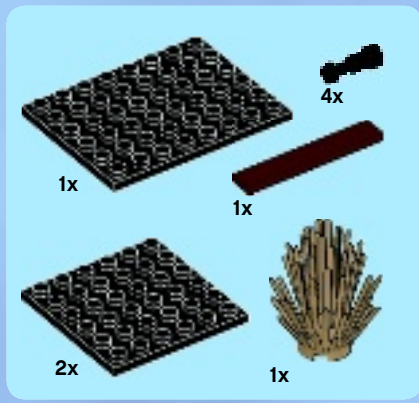

63

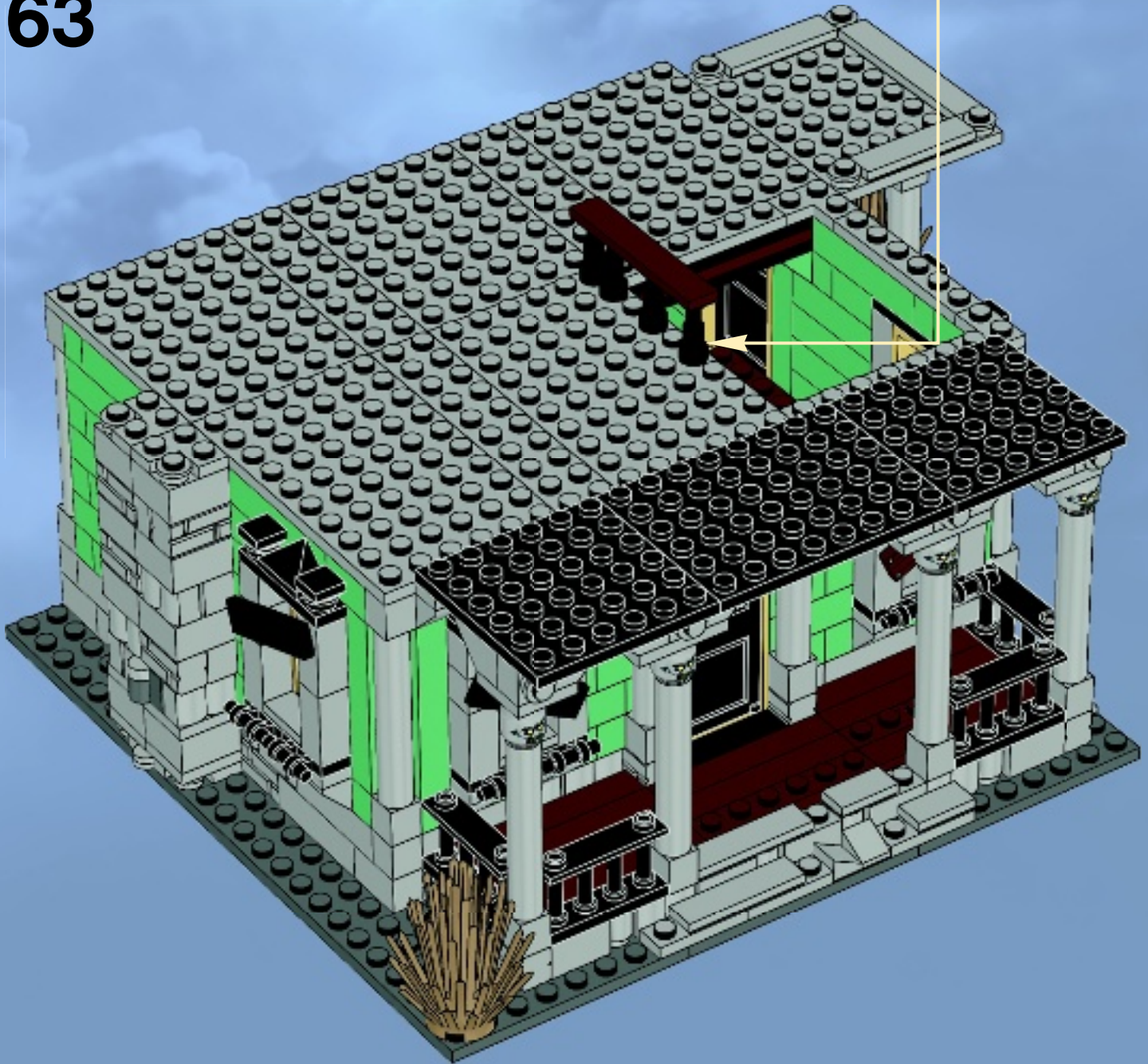



10x



6x

64

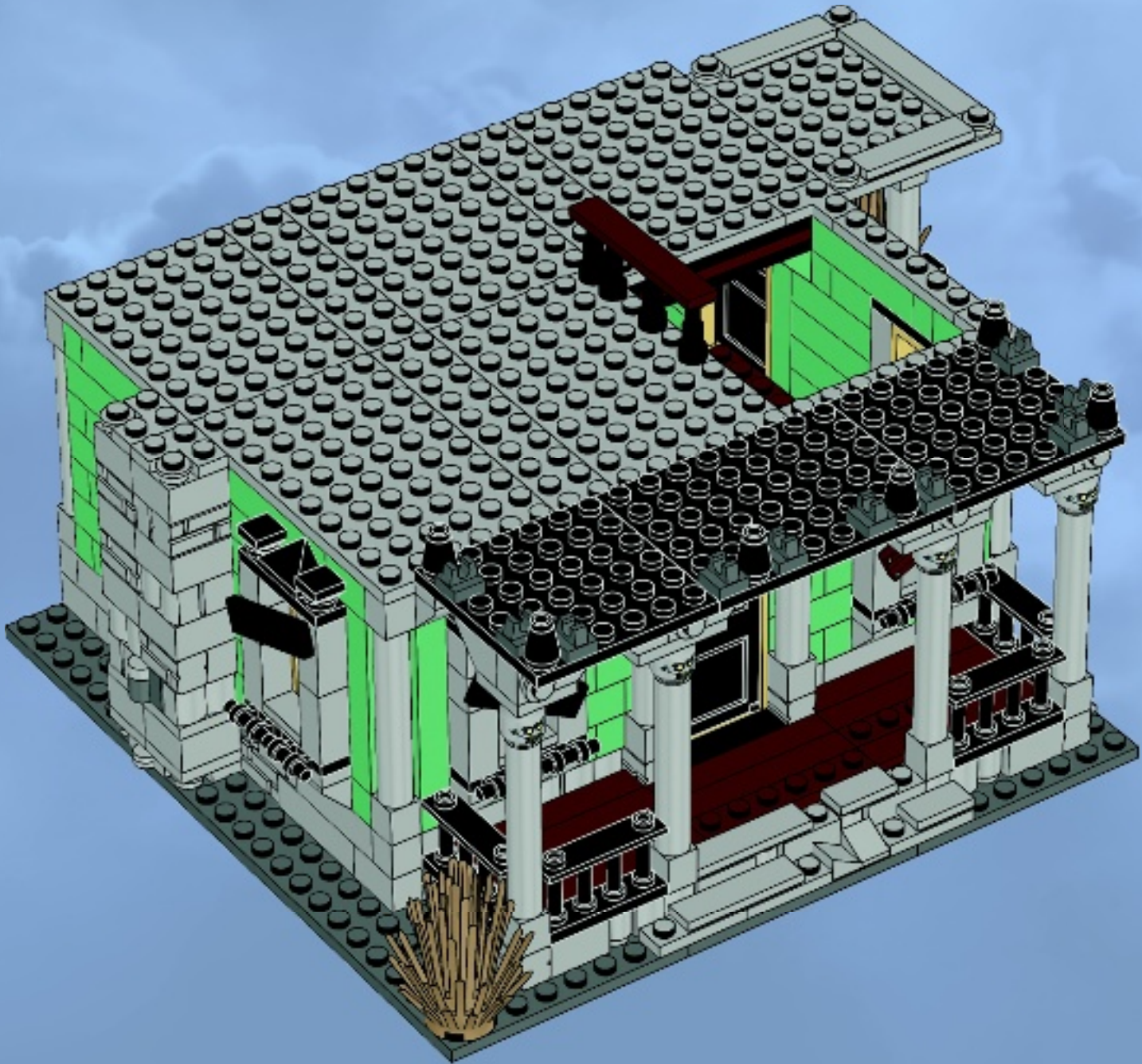



6x



3x



2x

65

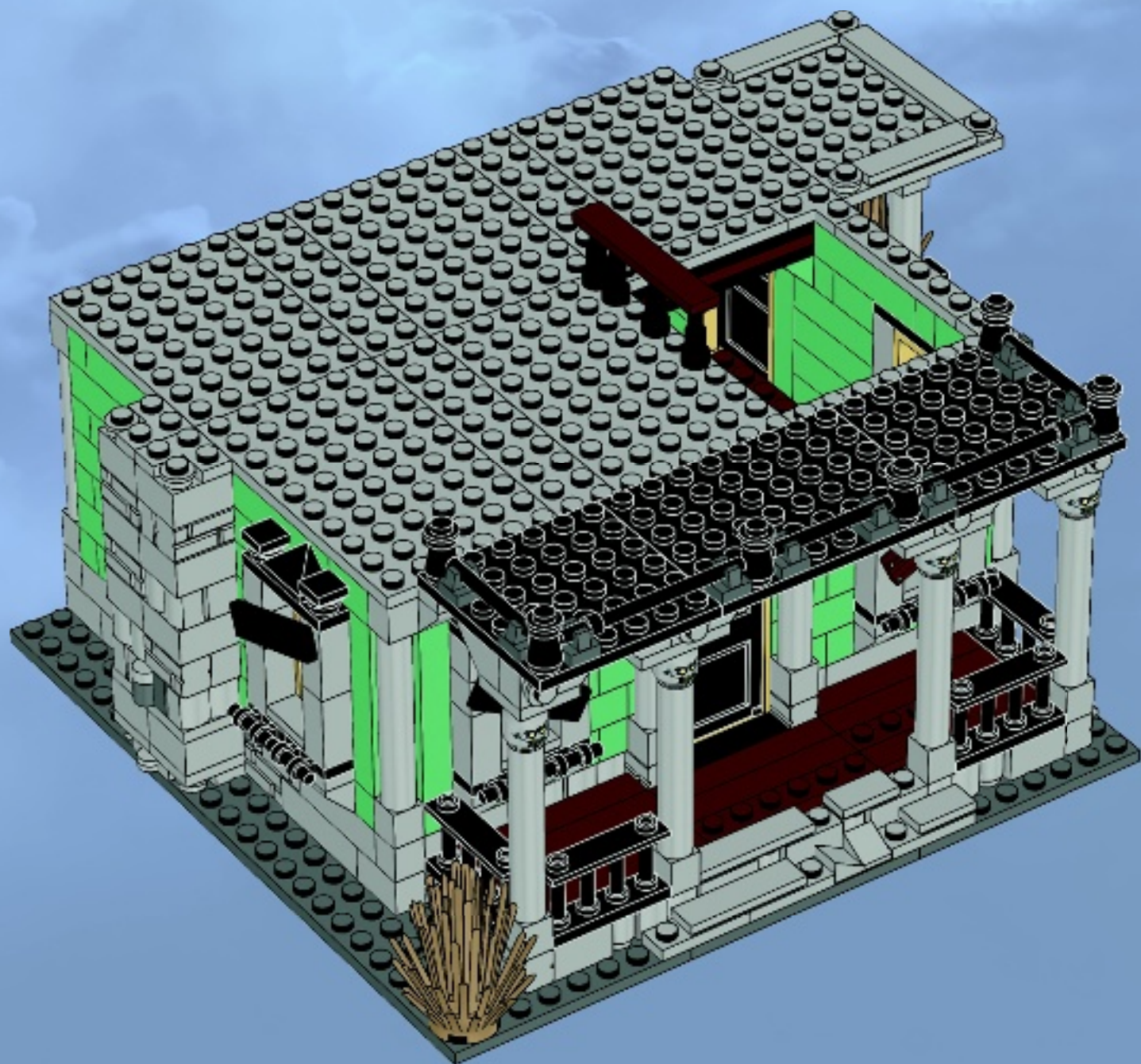



12x

66

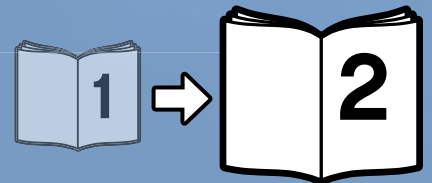

6015220 / 6015221

