

BDS 335/635 System

4K 3D Blu-Ray™ Disc System with Wifi® and Bluetooth®

Owner's Manual



harman/kardon[®]
by HARMAN

INTRODUCTION	3
DESCRIPTION AND FEATURES	3
UNPACKING	3
INCLUDED ITEMS	3
INSTALLATION LOCATION	4
BDS FRONT PANEL CONTROLS AND CONNECTIONS	5
BDS REAR PANEL CONTROLS AND CONNECTIONS	6
REMOTE CONTROL FUNCTIONS	8
SPEAKER PLACEMENT	9
MOUNTING OPTIONS	10
CONNECTIONS	11
SETTING UP THE SYSTEM	15
USING THE BDS SYSTEM	16
USING THE DISC PLAYER	16
USING DLNA	17
PLAYING FILES FROM USB DEVICES AND DATA DISCS	17
LISTENING TO INTERNET RADIO	19
LISTENING TO AUDIO SOURCES	19
LISTENING TO FM RADIO	19
CONNECT BDS TO HARMAN KARDON WIRELESS OMNI SYSTEM	19
TROUBLESHOOTING	20
SPECIFICATIONS	22

Introduction

Thank you for purchasing the Harman Kardon BDS 3D Blu-ray Disc™ system. The Harman Kardon BDS systems are sleek, high-performance 2.1 (BDS 335) and 5.1 (BDS 635) channel 3D Blu-ray Disc™ system with high fidelity amplified sound.

In the years since Harman Kardon engineers have pioneered the high-fidelity audio system, we have taken to heart the philosophy of bringing the joy of home entertainment to as many people as possible, adding performance and ease-of-use features that enhance the experience. The BDS series of home entertainment systems offers a complete home entertainment solution with a wealth of listening and viewing options in one sleek system.

To get the maximum enjoyment from your new BDS system, we urge you to read this manual thoroughly, which:

- Contains a description of the system's features
- Lists the items included in the box
- Describes the BDS system and its components
- Includes step-by-step instructions to help you set up and get started with the BDS system

CONTACT US: If you have any questions about this product, its installation or its operation, please contact your retailer or custom installer, or visit our website at: www.harmankardon.com

Description and Features

The BDS system features:

- 50 W per channel of powerful, clear audio
- Two HDMI inputs with 3D, UHD (4K) pass-through
- One HDMI output with Audio Return Channel (ARC)
- Wi-Fi connectivity, DLNA 1.5, vTuner, system updates and control, and streaming Internet services
- High quality Bluetooth audio streaming

Unpacking

The carton and shipping material used to protect your new system during shipment are specially designed to cushion it from shock and vibration. We suggest that you should save the carton and packing material for use in shipping if you move or if the unit ever needs repair.

To minimize the size of the carton in storage, you may have to flatten it. You can do it by carefully slitting the tape seams on the carton's bottom and collapsing it. You can store cardboard inserts in the same manner. Packing materials that cannot be collapsed should be saved along with the carton in a plastic bag.

If you do not wish to save the packaging material, note that the carton and other sections of the shipping-protection materials are recyclable. Please respect the environment and discard those materials at a local recycling center.

Remove the protective plastic film from the front-panel lens. Leaving the film in place will affect the performance of your remote control.

Included Items

The following are the items provided in the BDS system complete package.

- One Remote Control

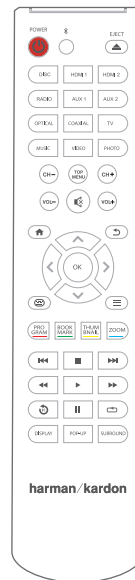

- One Power Cord

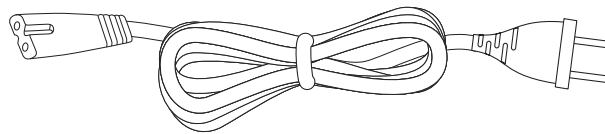

- One FM Antenna

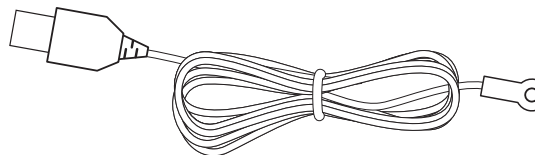

- One Wi-Fi Antennas



- One HDMI Cable

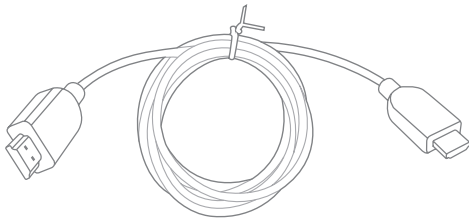

- Two AAA Batteries

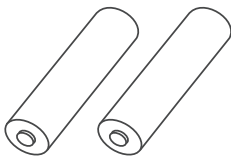

- One USB Cable (for Bluetooth Module software upgrades)



NOTE: If any of the listed items are missing, please contact Harman Kardon customer service at www.harmankardon.com

Installation Location

- To ensure proper operation and to avoid the potential for safety hazards, place the unit on a firm and level surface. When placing the unit on a shelf, be certain that the shelf and any mounting hardware can support the weight of the product.
- Provide adequate space behind the system for ventilation. If the product will be installed in a cabinet or other enclosed area, make sure there is sufficient air movement within the area.

- Do not place the unit directly on a carpeted surface.
- Avoid installation in extremely hot or cold locations or in an area that is exposed to direct sunlight or heating equipment.
- Avoid moist or humid locations.
- Do not obstruct the fan vents on the rear panel or ventilation slots on the sides of the unit or place objects directly over or next to them.
- Do not place the system directly on top of a product that generates excessive heat.
- Due to the heat generated by the system, there is a remote possibility that the padding on the bottom of the system may leave marks on certain wood or wood-veneer materials. Use caution when placing the system on soft woods or other materials that heat or heavy objects may damage. Some surface finishes may be particularly sensitive to absorbing such marks, due to a variety of factors beyond Harman Kardon's control, including the nature of the finish, cleaning materials used, normal heat and vibration caused by the use of the product, or other factors. Your warranty will not cover this type of damage to furniture, so exercise caution in choosing an installation location for the component and in performing normal maintenance practices.
- The BDS system requires either a Wi-Fi home network signal or access to a physical Ethernet connection to access certain features such as DLNA®, control from the Harman Kardon Remote app, and streaming Internet services.

Verify Line Voltage before Using

Your BDS system has been designed to be used with 100 – 240 Volt, 50 Hz/60Hz AC current and includes a detachable IEC power cable intended for use in the region where the system is sold. Connection to a line voltage other than that for which the unit is intended can create a safety and fire hazard and may damage the unit. If you have any questions about the voltage requirements for your specific model or about the line voltage in your area, contact your dealer before plugging the unit into a wall outlet.

Moving the System

Before moving the system, first disconnect it from the AC power and then remove the interconnection cables to other components.

Cleaning

When the system gets dirty, wipe it with a clean, soft, dry cloth. After unplugging the AC power cord, Wipe it with a soft cloth dampened with mild soapy water, then a fresh cloth with clean water. Wipe it dry immediately with a dry cloth.

IMPORTANT: NEVER use benzene, aerosol cleaners, thinner, alcohol or any other volatile cleaning agent.

NOTE: Do not use abrasive cleaners as they may damage the finish of metal parts in the BDS system. Avoid spraying insecticide near the unit.

BDS Front Panel Controls and Connections

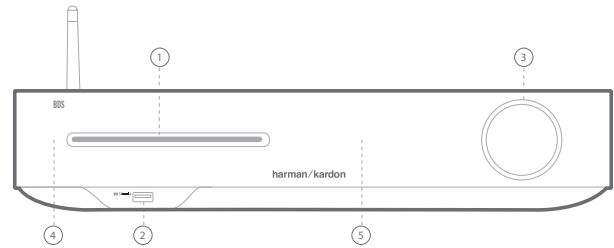

1. Disc Drive
2. USB input
3. Volume + / – and Sleep / Standby
4. Eject button
5. Information Display

1. Disc Drive: Insert a compatible disc into the slot. The BDS system’s disc slot accepts 5-inch (12 cm) and 3-inch (8 cm) discs.

2. USB Input: You can use the USB port to play audio files and show video and picture files from a USB device inserted into the port. Insert the connector or device into the USB port oriented so it fits all the way into the port. You may insert or remove the connector or device at any time - there is no installation or ejection procedure. You can also use the USB port to perform firmware upgrades. If an upgrade for the BDS operating system is released in future, you will be able to download it to the BDS system using this port. Complete instructions will be provided at that time.

IMPORTANT: Do not connect a PC or other USB host/controller to this port as it may damage both the BDS system and the other device.

NOTE: This USB port is rated for 1A output, which suggests, it is certified iPhone and iPod devices. There is a USB connector on the rear panel as well with similar functionality.

3. Volume + / – and Sleep / Standby: Volume can be adjusted by rotating this ring. Slide clockwise around the ring to increase volume, counterclockwise to decrease volume.

IMPORTANT: If the audio from the speakers begins to distort at high volume levels, reduce the volume as prolonged distortion can damage the system.

Your BDS receiver is designed to be compatible with region management information that is encoded on most Blu-ray Discs and DVD recordings. Your receiver will only play discs that contain region coding for the area where your receiver was shipped and intended for sale.

Area where sold	Blu-ray Disc region code	DVD region code
U.S.A., Canada		
Europe, Middle East		
Korea, S.E. Asia		
Mexico, Latin America		
Australia, New Zealand		
Russia, India		
China		

For example, BDS receiver shipped to and sold in the U.S.A. will only play Blu-ray Discs that contain region code A and DVD discs that contain region code 1.

Press the volume ring to turn the BDS system ON. If the system is already ON, press this button to push the system to Standby, Sleep or OFF mode.

The following table describes the different modes along with the LED display.

Mode	Operation	LED display
ON	Press the power button	White
Standby	Long press on the power button during Operational mode (2.5 seconds)	Weak Amber
OFF	Switch OFF of the Rear panel rocker switch	OFF
Sleep	<ul style="list-style-type: none"> No activity for 15 minutes in operational mode, Auto-standby ON Short press of Power button from Front panel during operational mode Short press on the remote control power button or power off command from external IR or remote app 	Amber

NOTE: While the system is powering on the volume ring will spin till the boot process is complete.

4. Eject button (appears only when a disc has been inserted): Touch this button to eject a disc from the BDS system's built-in disc slot. Before touching this button, make sure no objects block the disc-slot.

NOTE: If you do not remove the ejected disc within 30 seconds, it will automatically re-load into the disc slot for protection.

5. Information Display: Various messages appear on this display in response to commands and to show the audio/video that is playing, the BDS system's settings or other aspects of the BDS system's status as described throughout this manual.

BDS Rear Panel Controls and Connections

2.1-channel BDS

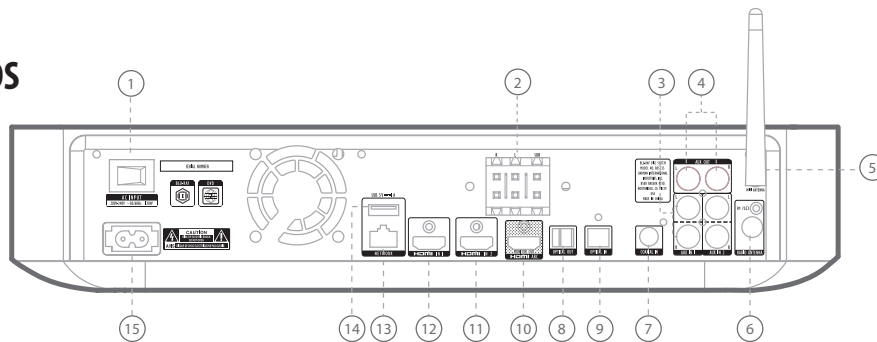

5.1-channel BDS

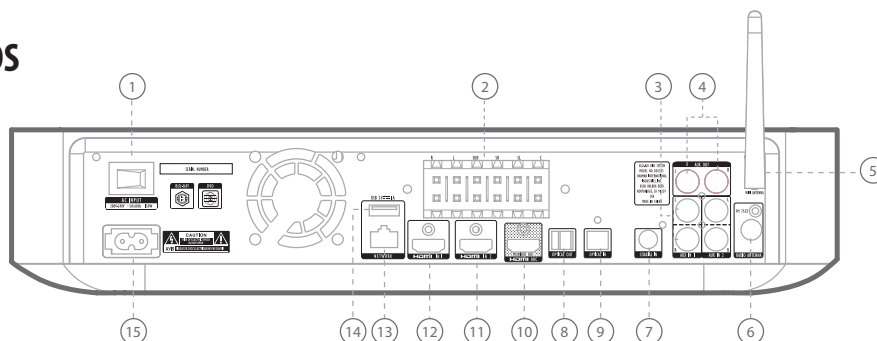

The following are the controls available in the rear panel of the BDS 335/635 System system:

1. Main power switch
2. Speaker outputs
3. Aux 1 input and Aux 2 input
4. Aux Output (optional HK Adapt)
5. Wi-Fi Antenna
6. FM radio antenna input
7. Coaxial Audio Input
8. Optical Audio Output (for optional HK Adapt)
9. Optical Audio Input
10. HDMI Output (ARC)
11. HDMI 2 input
12. HDMI 1 input
13. Wired network (RJ-45) input
14. USB input
15. AC power input

1. Main Power switch: This mechanical switch turns the BDS system's power supply ON or OFF. After you have made and verified all connections, set this switch to the ON position. During normal use, you will usually leave this switch set to ON; it cannot be turned ON or OFF using the remote control. To conserve energy when you are not using the system for an extended period of time, set this switch to OFF.

2. Speaker outputs: Use the speaker wires supplied with the speakers to connect the speakers to the proper terminals.

- The BDS 335 system has three outputs for left and right speakers and subwoofer.
- The BDS 635 system has six outputs for center, front left, front right, surround left, surround right speakers and subwoofer.

3. Aux 1 input and Aux 2 input: Use these connectors to connect to an audio source device (such as a tape deck). Do not connect a turntable to these connectors without a phono preamp.

4. Aux Output (optional HK Adapt): Use this to connect to an optional Harman Kardon Adapt. This will enable anything playing on your BDS receiver to be sent to other Harman Kardon Wireless speakers like an Omni 10 or 20. (See page 19 for more information.)

5. Wi-Fi Antenna: Connect the antenna accessory labeled Wi-Fi here for improved Wi-Fi reception.

6. FM radio antenna input: Connect the supplied FM antenna to this terminal.

7. Coaxial Audio Input: Connect the coaxial digital output of an audio source component here. The signal may be a Dolby Digital bitstream, a DTS bitstream or a standard PCM digital-audio bitstream.

8. Optical Audio Output (for optional HK Adapt): Use this to connect to an optional Harman Kardon Adapt. This will enable anything playing on your BDS receiver to be sent to other Harman Kardon Wireless speakers like an Omni 10 or 20. (See page 19 for more information.)

9. Optical Audio Input: Connect the optical digital output of an audio source component here. The signal may be a Dolby Digital, DTS® or standard PCM digital audio.

10. HDMI Output (ARC): Connect the BDS system's HDMI output to your TV's HDMI input. If your TV is 3D capable, then you can watch 3D content in 3D either from the BDS system's built-in disc player or from other 3D-capable source devices connected to the BDS system's HDMI Input connectors (see below). The system's HDMI output connection also contains an Audio Return Channel (ARC) that carries a digital audio signal from your TV or video display back to the BDS. It allows you to listen to HDMI devices that are connected directly to your TV (such as a digital TV tuner) without making an additional connection from the device to the BDS system.

NOTE: You must enable the ARC output of your TV. Consult your TV's instruction manual for information.

11. HDMI 2 input: You can connect up to two additional source devices to the BDS system provided the source devices have HDMI connectors. The HDMI connection transmits digital audio and video signals between devices, so you do not have to make any additional audio connections for devices you want to connect via an HDMI connector. The BDS system will pass 4K and 3D video signals from 3D capable HDMI source devices to the TV via the HDMI output connector.

12. HDMI 1 input: You can connect up to two additional source devices to the BDS system provided the source devices have HDMI connectors. The HDMI connection transmits digital audio and video signals between devices, so you do not have to make any additional audio connections for devices you want to connect via an HDMI connector. The BDS system will pass 4K and 3D video signals from 3D capable HDMI source devices to the TV via the HDMI output connector.

13. Wired network (RJ-45) input: Use a Cat. 5 or Cat. 5E cable (not supplied) to connect the BDS system's Network connector to your home network to enjoy content from DLNA and streaming services, as well as control from the Harman Kardon Remote app for iOS and Android. Additionally, system upgrades can be downloaded and installed from compatible devices that are joined to the network.

14. USB input: You can use the USB port to play MP3 and WMA audio files and show video and picture files from a USB device inserted into the port. Insert the connector or device into the USB port oriented so it fits all the way into the port. You may insert or remove the connector or device at any time - there is no installation or ejection procedure. You can also use the USB port to perform firmware upgrades. If an upgrade for the BDS operating system is released in the future, you will be able to download it to the BDS system using this port. Complete instructions will be provided at that time.

IMPORTANT: Do not connect a PC or other USB host/controller to this port, or you may damage both the BDS system and the other device.

NOTE: Both front and rear USB ports are rated at 1A and it is certified to charge iPhone and iPod devices.

15. AC power input: After you have made and verified all other connections, plug the supplied AC power cord into this input and into an unswitched AC outlet

Remote Control Functions

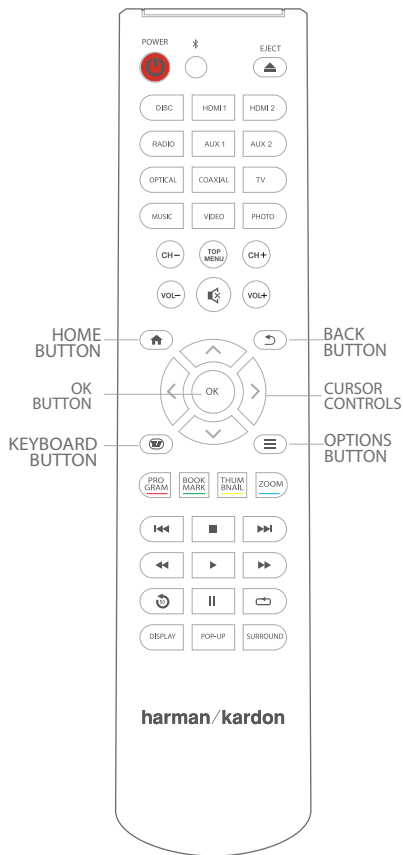

Power button: The BDS system has four different power modes:

- **OFF (ON/Standby indicator not illuminated):** When the rear-panel Main-Power switch is in the OFF position or the power cord is unplugged the BDS system is off and will not respond to any commands. Plugging the power cord into a live AC outlet and setting the Main Power switch in the On position will put the system into the Standby mode.
- **Standby (Power indicator glows weak amber):** The Standby mode minimizes energy consumption when you are not using the BDS system. When the system is in Standby, pressing the Power button turns it ON. To put the system into Standby when it is ON, press the Power button for more than two seconds.

NOTE: To conserve energy you can have the system automatically enter the Sleep mode whenever no control buttons have been pressed and no audio signal has been present for 15 minutes.

- **Sleep (Power indicator glows solid amber):** The Sleep mode mutes the BDS system's outputs and shuts off its OSD and front-panel display, but allows the system to automatically turn on and play audio in response to a signal from a Bluetooth device. When the system is in Sleep, pressing the Power button turns it on. To put the system into Sleep when it is ON, press the Power button momentarily.

- **ON (Power indicator glows solid white):** When the BDS system is ON, it is operational.

TV Power button: After you program the remote control, pressing this button turns the TV's power ON and OFF.

Eject button: Press this button to eject a disc from the BDS system's built-in disc player. Before pressing this button, make sure no objects are blocking the disc slot opening.

Source buttons: Press one of these buttons to select a source device. This action will also turn on the BDS system from the Standby mode.

- The first press on the Aux button switches the BDS system to the last-used of the sources such as Coaxial Digital, Optical Digital 1, Optical Digital 2, Analog Audio I, Analog Audio 2, and HDMI ARC. Each successive press advances the BDS system through those sources. Pressing the Aux button also places the remote into the auxiliary-component control mode, enabling the remote to use any pre-programmed and/or learned functions.

Pop-Up button: Pressing this button while playing a Blu-ray Disc recording or DVD displays its disc menu.

NOTE: This feature is disc-dependent. Not all DVDs have pop-up menus. If a DVD has no pop-up menu, pressing the Pop-Up button may display the disc menu, depending on how the disc's menu system is authored.

Display button: When you are playing Blu-ray Disc and DVD recordings, pressing this button activates a bar display containing information about the currently-playing disc or program. When you are playing a video from an inserted USB device, pressing this button displays the Status bar. This button does not function when the BDS system is playing materials from an iOS device, an auxiliary source or the radio. Pressing Display button has no action during playback of tracks and photo slides.

Channel +/- buttons: These buttons have no effect on the BDS system, but can be programmed to control functions on an Aux component. Pressing "Channel +/-" button, unit navigates to the Preset stations available in the FM Radio source.

Volume +/- buttons: Press these buttons to increase or decrease the volume of the BDS system's speaker outputs.

NOTE: The Volume +/- buttons do not change the volume of the HDMI audio output.

IMPORTANT: Do not turn the volume buttons up to or past the point where the audio from the speakers becomes distorted. Doing so can damage the speakers.

Mute button: Press this button to mute the sound from the BDS system's speaker outputs. Press the button again to unmute the sound.

NOTE: The Mute button does not mute the HDMI audio output.

Top Menu button: Displays the top menu of the Blu-ray Disc or DVD that is playing.

NOTE: This feature is disc-dependent. Not all DVDs have top menus. If the DVD has no top menu, pressing the Top Menu button may display the disc menu, depending on how the disc's menu system is authored.

Surround button: Pressing this button cycles through all of the surround-sound modes that are available for the active program. Each press of the Surround button will change to the next mode in line. A pop-up display will appear, showing the modes as you cycle through them.

NOTE: Not all surround modes will be available for all programs. The Surround Mode will be available based on the currently playing audio format through Disc/HDMI Input source.

Transport Control buttons: These buttons control the BDS system's built-in Blu-ray Disc player, iOS and USB devices and streaming sources. When the remote is in the Aux component control mode, they can control functions of the auxiliary component.

Replay button: Press this button to replay the previous 10 seconds of media playing on Blu-ray, DVD, CD, USB and data discs.

Repeat button: When the BDS system is playing a Blu-ray Disc recording or DVD, pressing this button cycles through the repeat modes such as Chapter, Title, OFF.

NOTE: Not all Blu-ray discs support repeat playback.

When the BDS system is playing a CD or listening to media stored on an iPod or USB device, this button cycles through the repeat modes such as One, All, OFF.

Home button: Pressing this button returns the on-screen display to the Home screen from whatever screen is active when the button is pressed.

Back button: Pressing this button exits the current on-screen menu and displays the previous screen.

OK button: Press this button to select the highlighted item on the on-screen menu.

Cursor buttons: Use these buttons to navigate through items on the on-screen menu.

Keypad button: Press this button to display a 10-keypad for entering letters and numbers, such as for network setup, disc chapter search and so on.

Options button: Pressing this button displays any available options for the item that is active at the time the button is pressed. When listening to an Aux source, pressing the Options button lets you adjust the audio delay to eliminate "lip sync" errors between the sound and picture when watching video programs with sound playing through one of the system's rear-panel audio inputs.

NOTE: Options button has no action during playback of tracks.

Program (Red) button: Press this button to create a programmed playback list for the currently-playing disc.

Zoom (Blue) button: Press the Zoom button to zoom in on or recede from a video image or slide. Use the Navigation buttons to zoom in on different sections of the image.

NOTE: This function is disc-dependent for Blu-ray Disc recordings and DVDs. Not all discs can be zoomed in.

Bookmark (Green) button: Press this button to activate the Bookmark function.

Thumbnail (Yellow) button: Press this button while playing a photo slide show to display thumbnail images of all photos in the slide show.

Red, Green, Yellow and Blue buttons: When the BDS system is playing a Blu-ray Disc recording, these buttons can activate features and menus that may vary from disc to disc. Refer to the menu instructions for each particular disc for more information.

NOTE: These Blu-ray Disc functions may override the Bookmark, Thumbnail, Program and Zoom functions.

Speaker Placement

Color-Coding System

The HKTS loudspeakers use the CEA color-coding system to make setting up your home theater speaker system as easy as possible. Your system includes a set of colored stickers that may be placed near the speaker terminals of each of the four satellite speakers according to the key below. It doesn't matter which satellite speaker is used for any of the front or rear positions. (The center speaker and powered subwoofer are already color-coded for you.)

Speaker Position	Wire Color Band
Front Left	White
Front Right	Red
Center	Green
Surround Left	Blue
Surround Right	Gray
Subwoofer	Purple

Front Speakers

Place the front speakers the same distance from each other as they are from the listening position (the place where you'll be when you listen to the loudspeakers). They should be placed at about the same height from the floor as the listener's ears will be. They also can be angled toward the listener.

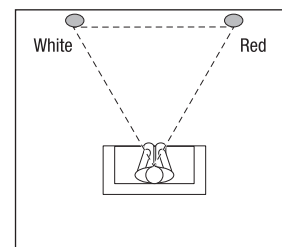

Center Speaker

The center speaker should be placed slightly behind (farther away from the listener) the front left and right speakers. Its center should be no more than 55 cm (2 feet) above or below the tweeters of the front left and right speakers. It is often convenient to set the center speaker on top of the television set, as shown in the drawing.

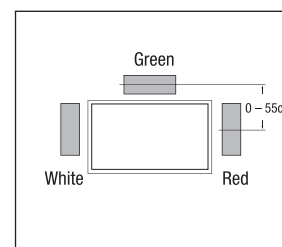

Subwoofer

The low-frequency sound reproduced by the subwoofer is mostly omnidirectional, and this speaker may be placed in a convenient location in the room. However, the best reproduction of bass will be heard when the subwoofer is placed in a corner along the same wall as the front speakers. Experiment with subwoofer placement by temporarily placing the subwoofer in the listening position and moving around the room until the bass reproduction is best. Place the subwoofer in that location.

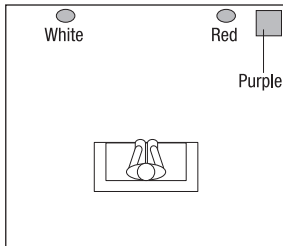

Surround Speakers

Place the two surround speakers slightly behind the listening position. Ideally, they should face each other and be at a level higher than the listeners' ears. If that is not possible, they may be placed on a wall behind the listening position, facing forward. The surround speakers should not call attention to themselves. Experiment with their placement until you hear a diffuse, ambient sound accompanying the main program material heard in the front speakers.

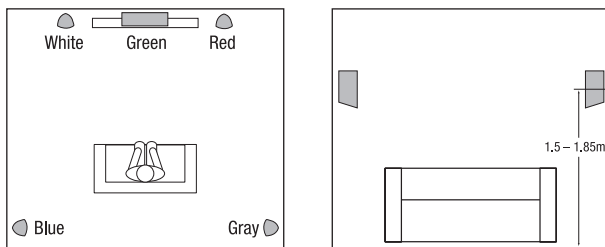

Mounting Options

You can place the satellite and center speakers on shelves using their built-in stands, or you can wall-mount them using the supplied hardware.

Wall-Mounting the Satellites

1. Remove the black shelf stand from the bottom of the speaker by unscrewing the bolt. Store the shelf stand and bolt in a safe place in case you need them in the future.

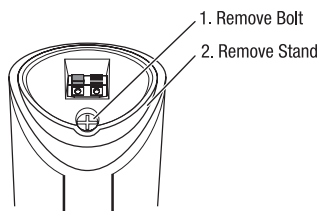

2. Determine the locations for the speakers. If possible, position the speakers so that the mounting screws (not included; use size #8) can be installed directly into a wall stud. If that is not possible, use optional wall anchors that are rated to support

at least 25 lb (11.3kg) and are appropriate for the construction and materials of your wall. **The customer is responsible for the proper selection and use of mounting hardware, available through hardware stores, to wall-mount the speakers properly and safely.**

3. Bring the speaker cable through the wall-bracket attachment plate, and mount the attachment plate on the wall in the desired location.

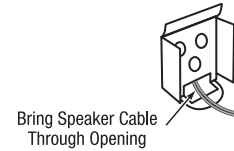

4. Thread the speaker cable through the arc-shaped opening on the top of the mounting bracket, not the screw hole.

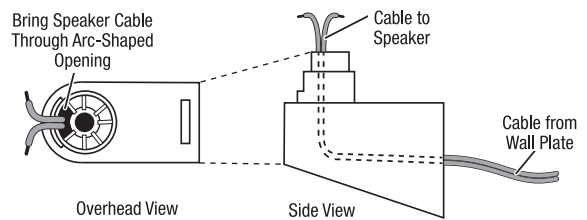

5. Attach the mounting bracket to the wall plate by inserting the tab at the top of the attachment plate into the slot on top of the bracket and snapping the bracket onto the attachment plate.

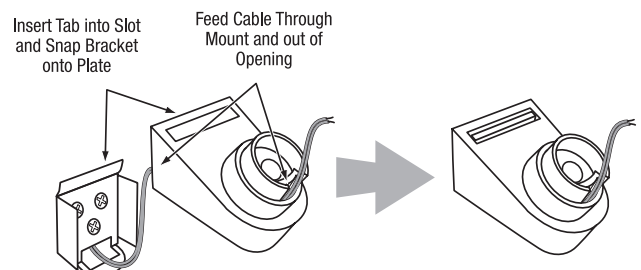

6. Fit the terminal cover onto the bracket as shown in the illustration below, then connect the speaker leads to the terminals on the underside of the speaker. Remember to observe the correct polarity.

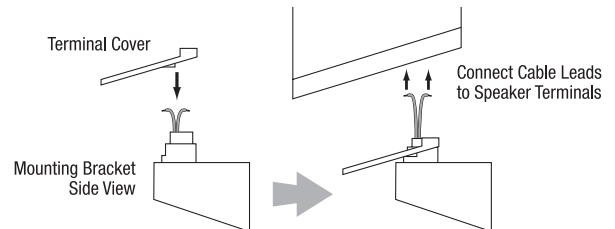

7. Fit the terminal cover into the opening on the underside of the speaker so that it is flush against the speaker and covers the terminals. Insert the supplied long bracket bolt up through the bottom of the bracket and terminal cover, and screw it into the threaded insert on the underside of the speaker. The bolt should be snug but not so tight as to prevent the speaker from pivoting on the bracket.

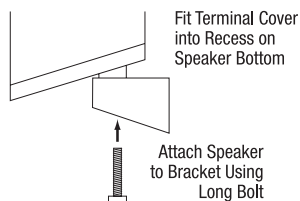

You can pivot the wall-mounted speaker from side to side; however, attempting to tilt it up or down will damage the bracket and possibly the wall, which would not be covered by your warranty.

Wall-Mounting the Center Speaker (BDS 635 ONLY)

1. Determine the location for the speaker. If possible, position the speaker so that one of the mounting screws (not included; use size #10) can be installed directly into a wall stud. If that is not possible, use optional wall anchors that are rated to support at least 25 lb (11.3kg) and are appropriate for the construction and materials of your wall. The customer is responsible for the proper selection and use of mounting hardware, available through hardware stores, to wall-mount the speaker properly and safely.
2. Bring the speaker cable through the wall-bracket attachment plate as shown, and mount the attachment plate on the wall in the desired location.

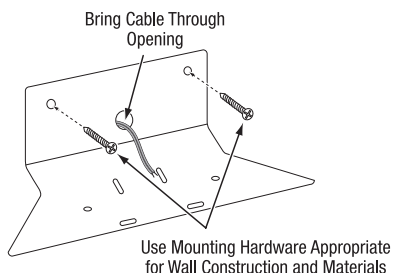

3. Remove the rubber pads from the foot rests on the bottom of the center speaker and connect the speaker leads to the terminals on the underside of the speaker. Remember to observe the correct polarity.

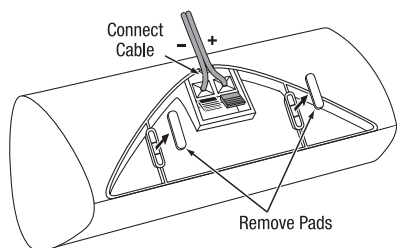

4. Use the supplied screws to attach the speaker to the wall-mount bracket. The screws thread into the center foot-rest openings that were exposed when you removed the rubber pads in the previous step.

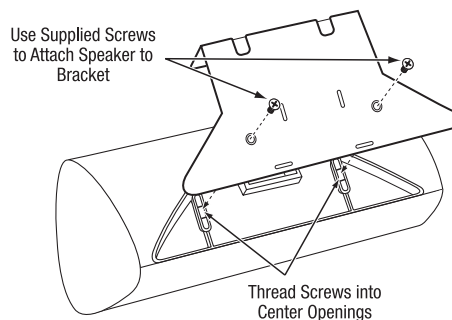

Connections

CAUTION: Before making any connections to the BDS system, ensure that the AC cord is unplugged from the system and the AC outlet. Making speaker connections with the system plugged in and turned on could damage the speakers or the BDS system.

Speakers and the BDS system have corresponding (+) and (-) connection terminals. Most speakers use red to denote the (+) terminal and black for the (-) terminal. Your BDS system has color-coded speaker terminals:

BDS 335 System	
White	left channel (+)
Red	right channel (+)
Purple	subwoofer (+)
Black	(-) on both channels

BDS 635 System	
White	front left (+)
Red	front right (+)
Blue	surround left (+)
Gray	surround right (+)
Green	center (+)
Purple	subwoofer (+)
Black	(-) on all channels

Black is used to denote the (-) terminals of all channels on the BDS system.

Be sure to connect each speaker identically: (+) on the speaker to (+) on the BDS system and (-) on the speaker to (-) on the BDS system. If one or more speakers are miswired, it results in thin sound, weak bass and a poor stereo image.

CAUTION: Make sure the (+) and (-) bare wires do not touch each other or the other terminal. Touching wires can cause a short circuit that can damage your BDS system.

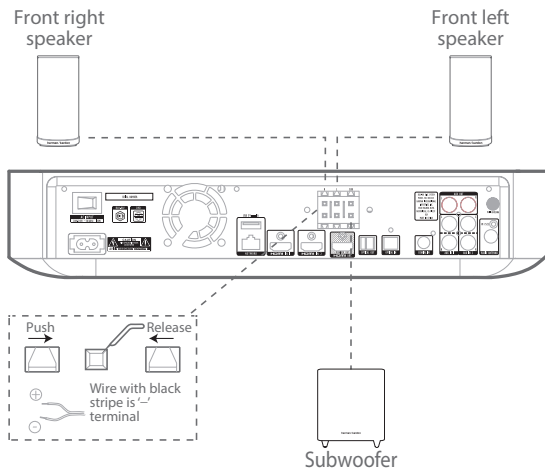

Connecting the FM Antenna

Connect the supplied antenna to the FM Antenna connector as shown in the following illustration. Fully extend the antenna wire and move it to different positions until you get the best reception of your favorite stations.

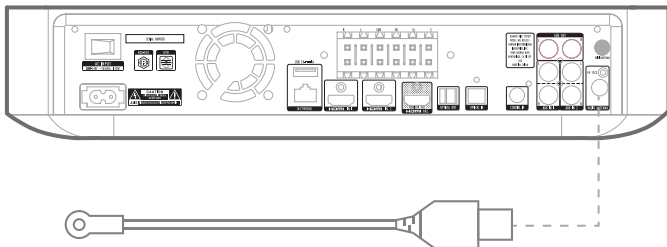

Connecting a TV or Video Display

Use the supplied HDMI cable to connect the BDS system's HDMI output to your TV/video display's HDMI input. The BDS system is HDMI version 1.4b with 3-D and 30/36-bit Deep Color.

NOTE: If you have devices (such as a digital tuner) already connected directly to your TV, you can feed their sound to the BDS system via the HDMI output connector's Audio Return Channel, and they will not require additional connections to the system.

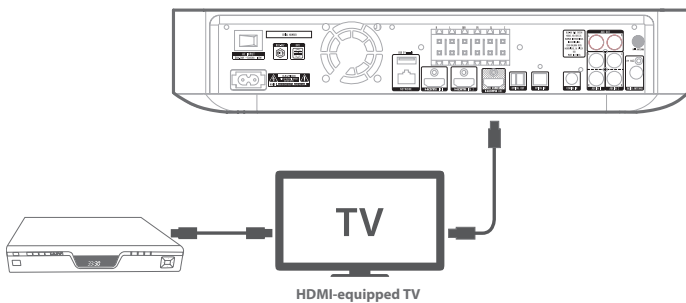

Connecting Your HDMI Source Devices

If you have any source devices with an HDMI connector, using it will provide the best possible video and audio performance quality. Since the HDMI cable carries both digital video and digital audio signals, you do not have to make any additional audio

connections for devices you connect via an HDMI cable.

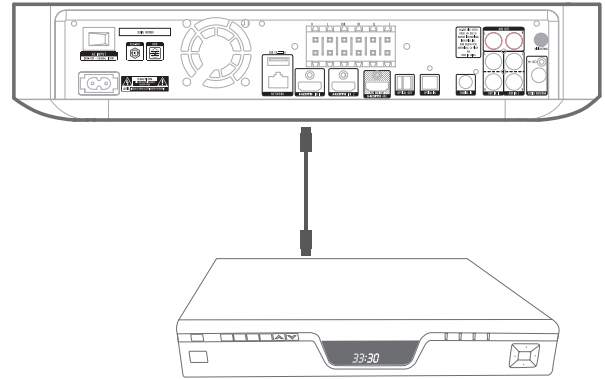

Connecting Your Digital Audio Source Devices

Optical Audio Source Device

If you have at least two non-HDMI source devices with optical digital outputs, connect them to the system's optical digital audio connectors.

Coaxial Digital Audio Source Device

If one of your non-HDMI source devices has a coaxial digital output, connect it to the system's Coaxial Digital Input connector.

NOTE: Make only one type of digital connection (HDMI, optical or coaxial) from each device.

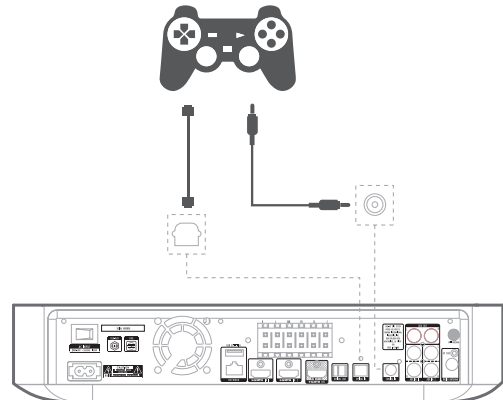

Connecting Analog Audio Source Devices

Use the system's Aux In connectors for up to two source devices that don't have HDMI or digital audio connectors.

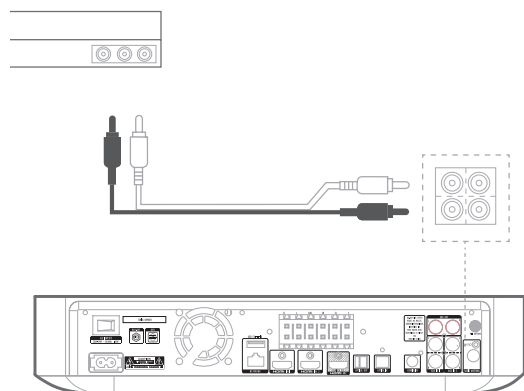

Connecting to a Local Area Network (LAN)

Use a Cat. 5/5E network cable (not supplied) to connect the BDS system's network connector directly to a network router, a network switch, a network modem or an Ethernet network wall jack that has Internet access.

NOTE: If you have a wireless home network, you can optionally skip this step and use the BDS on-screen menus to connect it to Wi-Fi later on.

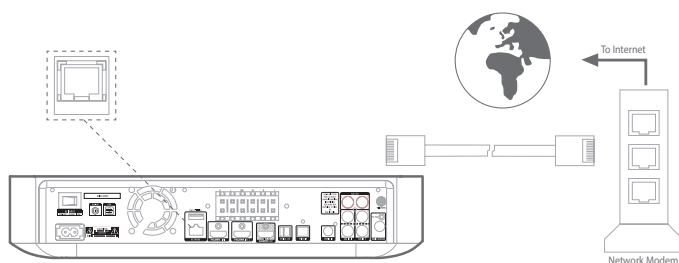

Connecting the AC Power

The BDS system comes with a detachable AC power cord. This type of cord makes it easier for you to install and connect all other system wiring to the system's rear panel.

NOTE:

- The power requirement for the BDS system is 200V – 240V, +/-10%, 50/60Hz, 130W (BDS 635 system) or 90W (BDS 335 system).
- Before connecting the AC power cord to a wall outlet, confirm that you have correctly made all of the speaker connections, video connections and audio component connections.

Connect the female end of the system's detachable power cord to the rear panel AC Power connector. Plug the other end into a working, unswitched AC outlet.

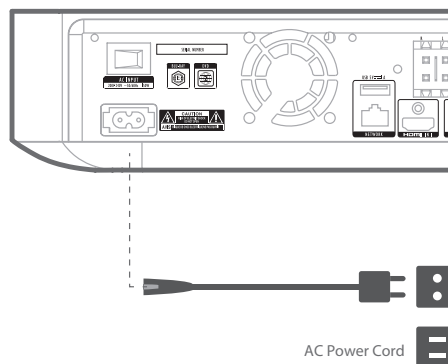

Connecting to Network through Wi-Fi

You can connect the unit to the internet through Wi-Fi.

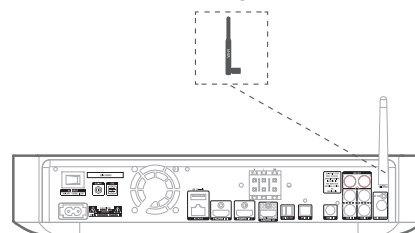

The following instructions help you to connect your unit to the network.

- From the home screen, select **Settings > Network**.
- Make sure Network Connection is set to ON.
- Set Type to **Wi-Fi**.
- Select your preferred method of connecting to your wireless network under **Setup Wi-Fi**.

There are four options for setting up wireless networks:

- Choosing a wireless network
- WPS PIN
- Custom Setup

Choosing a Wireless Network

To choose a wireless network:

1. Select **Choose a network** from the **Setup Wi-Fi** list.
2. Follow the instructions on the screen to select your wireless home network and enter your security password, if applicable.

WPS PIN

1. Select **WPS PIN** from the Setup **Wi-Fi** list. A PIN code is displayed on the screen.
2. Enter this same PIN on your wireless router's internal web page to connect. See your router's user manual for more details.

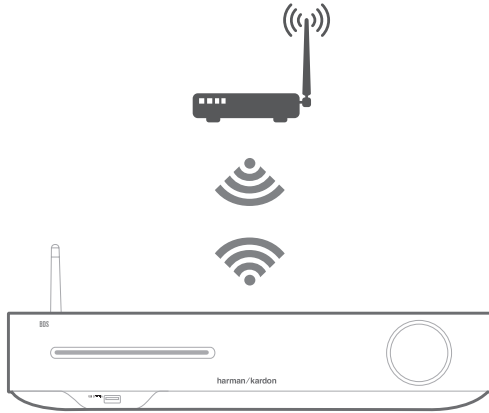

Custom Setup

Choose the custom setup option if you want to manually connect the BDS system to Wi-Fi. To connect the BDS system to a specific Wi-Fi network, you need to enter the Wi-Fi network name and password in the network settings. Confirm the SSID name.

Preparing the Remote Control

Installing the Batteries

Your system's remote control uses two AAA batteries (supplied). Insert the batteries as shown in the illustration, making sure to observe the correct polarity.

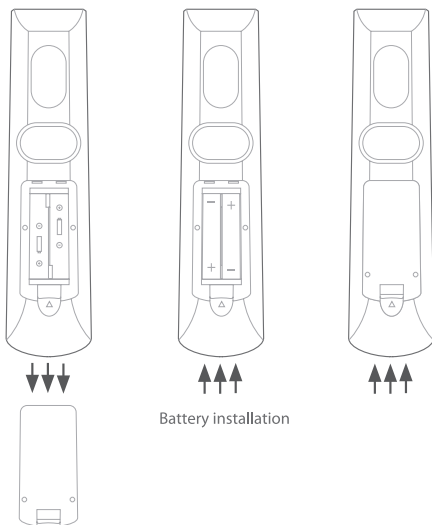

Using the Remote Control

When using the remote control, remember to aim it towards the system's front panel. Make sure that no objects, such as furniture, block the remote's view of the system. Bright lights, fluorescent lights, and plasma-video displays may interfere with the function of the remote.

- The remote control has a range of about 20 feet (6.1m), depending on the lighting conditions.
- You can use the remote at an angle of up to 30° to either side of the BDS system.

If the remote seems to operate intermittently, or if pressing a button on the remote does not cause the remote control backlights to light up, make sure that the batteries are inserted correctly. If the remote still operates intermittently, replace all two batteries with new ones.

Setting up the System

To set up your BDS system, you will use the remote to navigate through all of the onscreen menus and to make selections from them.

- Use the Cursor Up/Down buttons to navigate through the menu list.
- To select a highlighted item, press the **OK** button. The screen will change depending on your selection.
- To return to the previous screen, press the Back button ◀◀.

1. Select your Language



2. Choose your TV Resolution



3. Select your TV Aspect Ratio



4. Select your Network Settings. Enter your Wifi password as requested



5. Upgrade to the latest system information. Choose Internet



6. Setup is successful



Using the BDS System

Home Menu

Press the  to display the Home Menu screen:



If a disc has been inserted into the system's built-in disc slot, it will be displayed on the list as either CDDA (CD), DVD Video (DVD) or Blu-ray Disc. If you have inserted a USB device into the system's USB port, it will appear on the list as USB.

NOTE: Digital and analog audio sources connected to the system's rear-panel digital and line inputs will not appear on the list. These sources can be accessed from the AUX source in the upper right of the Home Menu screen or by pressing the Aux input button on the remote control.

To select a source from the list, use the Cursor Up/Down buttons to highlight the desired source, and then press the OK button to select it. You can also select a source directly by pressing its Input button on the remote.

NOTE: Depending on the sources available in your region, there may be a second Home Menu screen for additional sources. Press the Cursor Down button while the cursor is on the bottom row of sources to access this additional screen.

Using the Disc Player

You Should Know

Disc Handling Precautions

- To keep the disc clean, handle the disc by its edge. Do not touch the surface.

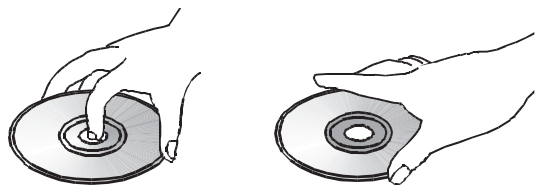

- Do not stick paper or tape on the disc. If there is glue (or a similar substance) on the disc, remove the substance completely before using the disc.
- Do not expose the disc to direct sunlight or heat sources such as hot air ducts or leave it in a car parked in direct sunlight, as there can be a considerable rise in temperature inside the car.
- After playing, store the disc in its case.

- Do not write on the label side with a ball-point pen or other sharp writing utensils.
- Be careful not to drop or bend the disc.

Disc Cleaning Precautions

- Before playing, clean the disc with a cleaning cloth. Wipe the disc from the center out.
- Do not use solvents such as benzene, thinner, commercially available cleaners or anti-static spray intended for vinyl LPs.

Regional Coding

Your BDS system is designed to be compatible with region management information that is encoded on most Blu-ray Disc recordings and DVD recordings. If there is a region code on a disc other than the one your BDS system is designed for, it will not play in your BDS system.

Copyright

Audio-visual material may consist of copyrighted works that must not be recorded without the permission of the owner of the copyright. Please refer to relevant laws covering copyright protection.

Copy Protection

Your BDS system is in compliance with HDCP (High-Definition Copy Protection), and a video display connected via the HDMI output must also be HDCP-compliant.

The BDS system supports Rovi copy protection. On Blu-ray Disc recordings and DVD discs that include a copy-protection code, if the contents of the disc are copied using a VCR, the copy-protection code prevents the videotape copy from playing normally.

Supported Disc Formats

The BDS system can play the following types of discs (5"/12 cm, and 3"/8 cm size):

- BD-Video (single-layer or double-layer)
- DVD-Video
- DVD+R/+RW
- DVD-R/-RW
- CDDA (CD digital audio)
- CD-R/RW
- CD+G discs are not supported.

Loading and Playing a Disc

Hold the disc horizontally when loading it, and insert it gently into the Disc slot. The disc loading mechanism will take the disc and slide it into the unit.

- Do not load more than one disc into the Disc slot.
- Do not load the disc upside down.

After loading a disc into the player, press the **Play** button to begin playback.

Use the **Play, Pause, Stop, Prev/Step, Next/Step, Search Forward/Slow** and **Search Reverse/Slow** buttons to control disc playback.

Playback Features

Content playback control (Picture): You can control the picture using the buttons **Play/Pause/Stop/Previous/Repeat/Next/Rotate/Zoom**.

NOTE: The unit shall support the background music and picture slideshow simultaneously.

Content playback control (Music): You can control the picture using the buttons such as **Play/Pause/Stop/Previous/Repeat/Next/Rotate/Backward/Forward**.

Content playback control (Video): You can control the picture using the buttons such as **Play/Pause/Stop/Previous/Repeat/Next/Rotate/Backward/Forward**.

NOTE: The unit shall support the video formats such as AVI/MPG/H264/MKV/DivX.

Using DLNA

The Harman Kardon BDS system supports DLNA 1.5 Digital Media Player (DMP), Digital Media Renderer (DMR). Only supported media files will be played or supported metadata displayed on the screen. The supported files include audio, video, and photographs. The BDS system allows two DLNA servers to work simultaneously for the case that music playing from DLNA server1 and slide show with JPEG from DLNA server2. It supports both the wired and wireless interfaces. The BDS can be controlled from an external control point.

- Stop – Terminates the streaming
- Source selection – Terminates the streaming controlled by external control point and goes to respective source mode
- Power – Terminates the streaming controlled by external control point and goes to sleep mode
- Volume control – Volume can be controlled by the external control point
- Clear/Exit – Terminates the streaming controlled by the external control point and goes to the previous mode/screen
- Home – Terminates the streaming controlled by the external control point and goes to home screen

NOTE: Control functions will differ as per different DMC.

Playing Files from USB Devices and Data Discs

Your BDS system can play MP3 (up to 320 kbps bitrate) audio files, FLAC tracks, display JPEG photos and show MPEG 1 (layer 1), MPEG 2 (layers 2 and 3), WMA, WAV and DivX Plus HD profile audio/video files stored on a USB device or a CD/DVD data disc.

To access files on a device inserted into the system's USB ports, press the Home button and select Music, Photos, or Videos from the sources.

The screen will then show the device's file structure. Selecting a folder will show all files of the selected type of media in the folder. If there are files of the selected type in the device's root directory, they will also be shown.

To move up one directory level, press the Cursor Left button or select the arrow folder.

Playing Music Files

Music files can be played from connected USB drives, DLNA servers on your home network, or inserted data discs (Blu-ray, DVD, or CD). From the **Home Menu** screen, select **Music**. Select a folder containing music files and highlight a music file in the folder.



Selecting a music file plays the file. If there are other music files in the folder that follow the selected file, the system will play them in the order they appear on the on-screen display.

If a selected MP3 file has an album cover-art ID3 tag, the art will be displayed on the screen.

Use the **Play, Pause, Stop, Prev/Step, Next/Step, Search Down/Slow** and **Search Up/Slow** buttons to control music-file playback. See Remote Control Functions, on page 9, for more information about the functions of these buttons.

When the BDS system is playing music files from a USB device or CD data disc, the Repeat and Options functions are slightly different from when they are playing Blu-ray Disc recordings, DVDs and music CDs.

Pressing the Repeat button cycles through the following repeat modes: 1 (song), All (folder), OFF. The active repeat mode is indicated in the screen's top bar.

While playing music files from a USB device, you can also view photos that are on the same media. Press the Home button while the music file is playing, navigate to a folder containing photo files, and select a photo file to begin a slide show.

Viewing Photos

Photo files can be played from connected USB drives, DLNA servers on your home network, or inserted data discs (Blu-ray, DVD, or CD).

1. From the Home **Menu screen**, select **Photo**.
2. Select a folder containing photo files and highlight a photo file in the folder. A thumbnail of the highlighted photo will be displayed on the right of the screen.



3. Use these remote buttons while viewing photos:
 - **Play button:** Press this button to begin a slide show that displays the photos in the current folder or directory level (starting with the highlighted JPEG) for 15 seconds in the order they appear in the folder.
 - **Pause button:** Press this button to freeze the current photo on the screen. Press the Play button to resume the slide show.
 - **Stop button:** Press to end the slide show and return to the directory.
 - **Next/Step and Previous/Step buttons:** Press these buttons to skip to the next or previous photo file in the slide show or directory.
 - **Cursor Up button:** Pressing this button while a photo is displayed rotates the photo 180°.
 - **Pressing this button while the directory list is displayed highlights the previous item in the directory.**
 - **Cursor Down button:** Pressing this button while a photo is displayed shows a mirror image reflection of the photo. Pressing this button while the directory list is displayed highlights the next item in the directory.
 - **Cursor Left button:** Pressing this button while a photo is displayed rotates the photo 90° counter clockwise. Pressing this button while the directory list is displayed jumps to the next higher directory level.
 - **Cursor Right button:** Pressing this button while a photo is displayed rotates the photo 90° clockwise.
 - **Options button:** Pressing this button while a photo is displayed shows the Options menu, which gives you the following options:

- **File:** Select a file to view.
- **Play Mode:** View files in their normal order, in random order (until you press the Stop button) or in shuffle order (displays each image in the folder one time in random order, then returns to the directory).
- **Slide Show:** Select the amount of time you want each slide to be displayed: 5 seconds, 15 seconds or 30 seconds.
- **Transition:** Select from various types of image-to-image transitions.
- **Sound:** Select a music file to play the sound.
- **Thumbnail (Yellow) button:** Pressing this button while playing a slide show displays thumbnail images of all photos in the slide show. Use the Cursor and OK buttons to highlight and select images to view.
- **Zoom (Blue) button:** Pressing this button during a slide show freezes an image and zooms in 2x size. Additional presses of the button change the zoom to 3x, 4x, 1/2x, 1/3x and 1/4x size.

Playing Videos

To play videos in the BDS system:

1. In the top directory, select the **Video** or **AVCHD** folder.
2. Select a folder containing video files and highlight a video file in the active folder.
The video will automatically play. If there are other video files in the folder, the BDS system will play each one in the order they appear on the on-screen menu.



- Use the **Play, Pause, Stop, Prev/Step, Next/Step, Search Forward/Slow and Search, Reverse/Slow** buttons to control music file playback.

- When the BDS system is playing video files from a USB device or CD data disc, the Repeat and Options functions are slightly different from playing Blu-ray Disc recordings and DVDs. Repeat button: Pressing this button cycles through the repeat modes such as 1 (current video), All (folder), Off.
- Options button: Pressing this button displays any available options for the video that is currently playing File, Title, Chapter, Time, Mode, Audio, Subtitle, Code Page, Bitrate, Advance, Replay, Adjust Lip Sync, 2D to 3D, 2D to 3D level, Video mode, Sound and Find.

Viewing HDMI Sources

Plug in an HDMI source device into the HDMI port on the back panel of the BDS system to view the available HDMI sources and use the remote control to accept the HDMI source you want. Connecting to an HDMI source allows you to transmit digital audio and video signals. You can connect game players, set-top-box, TV box to these inputs. It can transfer high quality audio and video.

Listening to Internet Radio With vTuner

Now you can listen to any Internet radio station in the world using vTuner. There are 2 ways to access internet radio on BDS:

1. Select vTuner on the BDS home screen.
2. Press the RADIO button on the remote control. Pressing the button twice will toggle between vTuner and AM/FM.

vTuner can help you can easily find and manage internet radio stations:

1. Find local radio stations based on your geography
2. Search stations by genre
3. Search podcasts
4. Save Favorite radio stations to a list

For more information about vTuner, please visit www.vtuner.com.

Listening to Audio Sources

Press the Aux button on the remote control. The system will switch to the audio input that was selected last. Subsequent presses of the Aux button will advance through the audio inputs in the following order: Coax In, Optical In 1, Optical In 2, Aux In 1, Aux In 2 and HDMI ARC (Audio Return Channel). The Aux Input Now Playing screen will be displayed on the TV or flat-panel display.

In addition to playing the Aux source through the system, pressing the Aux button places the remote in the Aux-control mode. If you have programmed the remote to control an auxiliary component (either by entering in a code number or teaching commands to the remote), the remote operates according to that programming mode.

Lip sync delay: When playing an aux source, audio and video processing circuitry may create a slight delay between the picture and sound. Pressing the Options button helps you adjust the audio delay to eliminate "lip sync" errors that may occur between the sound and picture in video programs with sound playing through one of the system's rear panel audio inputs. Use the Cursor Up/Down buttons to increase or decrease the audio delay until the perceived lip-sync errors disappear and the sound and picture are properly synchronized. The amount of audio delay is shown on the system's front panel Information Display.

Bluetooth

Bluetooth connectivity lets you stream audio wirelessly from a device that has been paired with the BDS system. After you have paired the BDS system with a Bluetooth device, you can select Bluetooth as the active source from the Home Menu.

Bluetooth source can also be selected by pressing Bluetooth button from the remote.

Bluetooth source is also selected when there is streaming of Music from the paired Android/iOS/Windows device.

Listening to FM Radio



Radio Input button: Pressing this button selects the BDS system's built-in FM radio as the system's active audio source. Pressing this button also puts the remote control into the control mode for the radio.

NOTE: Pressing this button when the BDS system is in the Standby mode will switch it on. If no station is found in the seek mode, it will come back to the original frequency.

Auto scan: Press the **Auto scan** button on the on-screen display to automatically scan the FM band and automatically set strong frequencies as presets.

Bookmark button: Bookmark button sets the currently tuned frequency as preset station.

Previous/Step button  and **Next/Step button** : Pressing these buttons scans to the next higher or lower receivable radio station.

Search/Slow Reverse button  and **Search/Slow Forward button** : Pressing these buttons increases or decreases the tuned frequency.

Channel +/- buttons: Pressing these buttons changes to the next higher or lower preset station.

Home button: Pressing the Home button will switch the OSD to the Home screen while the radio continues to be heard through the BDS receiver. To display the Radio Now Playing screen again, Select FM Radio source from Home Menu.

Quick-Recall Preset Stations

You may assign 3 radio stations as "quick-recall presets". Each of these stations occupy the #1, 2 and 3 addresses in the radio preset list. You may quickly cycle through these three stations by pressing the THUM button. Follow these steps to assign a quick-recall preset:

1. Use the tuner function to locate your desired radio station.
2. Press and Hold the THUM button--the Station preset address 1,2, or 3 starts blinking
3. Press the CH+/- button to select the desired preset number: #1, 2, or 3
4. Press THUM again to save to the desired preset.
5. Press the THUM button at any time to loop the first 3 stations in the preset list.

Connect BDS to Harman Kardon Wireless Omni System

You can now link your BDS system to your Harman Kardon HD Wireless Omni system. To do this, you will need a Harman Kardon Adapt and at least one wireless speaker, such as a Harman Kardon Omni 10 or Omni 20.

1. Connect the audio output of the BDS to the audio input of the Adapt.
2. Connect the power cable to the Harman Kardon Adapt.
3. Power on the system.
4. Press the "Link"-button on top of the Adapt until the LED turns Green

In this configuration, whatever is playing on the BDS will be "streamed" to other Harman Kardon Wireless HD speakers. To hear the audio that is playing on the BDS, simply press the Link button on the respective wireless speaker.

Troubleshooting

Problems	Solutions
The system does not power up (the Power indicator is not lit)	<ul style="list-style-type: none"> • Check whether the system's Power cord is properly plugged into the system's AC Power connector. • Check that the Power cord is plugged into a working AC outlet. If the outlet is controlled by a switch, make sure the switch is set in the ON position. • Check that the system's main power switch (located on the rear panel) is in ON position.
Sound plays through the speakers, but there is no TV picture	<ul style="list-style-type: none"> • Check the HDMI connection between the system and the TV. • Check the HDMI connection or Component Video connection between the source device and the BDS system. • Check that the TV is turned on and is set to the proper input source. • Unplug the HDMI cable from the TV and plug it back in again.
There is a constant hum in the sound	<ul style="list-style-type: none"> • Check that all input cables are plugged all the way into their connectors. • Check that all cables are at least 10 ft (3.3m) from fluorescent lights. • Check that all cable connectors are clean. If necessary, wipe them with a cloth slightly moistened with alcohol.

Troubleshooting

Problems	Solutions
The disc does not play	<ul style="list-style-type: none"> • Check that the disc is inserted correctly (label side up). • Check that the disc is the correct type: BD Video (single-layer or dual-layer), • DVD-Video, DVD+R/+RW, DVD-R/-RW, CDDA (CD digital audio), CD-R/RW. Other disc types will not play. • Check that the disc surface is clean and not scratched.
There is noise or other interference in the picture while playing a Blu-ray Disc recording or DVD	<ul style="list-style-type: none"> • Check that the disc surface is clean and not scratched.
The sound and picture are out of sync when playing to an Aux source	<ul style="list-style-type: none"> • Press the Options button and perform the Lip Sync adjustment to bring the sound and picture into synchronization.
Cannot tune in radio stations	<ul style="list-style-type: none"> • Check that the FM antenna is correctly connected. • Adjust the antenna's position. If necessary, use a powered FM antenna or an outdoor FM antenna.
The system does not respond to remote-control commands	<ul style="list-style-type: none"> • Replace all three remote-control batteries with fresh ones, and make sure that they are installed with the correct polarity. • Hold the remote closer to the system. • Check that the system's remote sensor is in the line of sight of the remote control.
The remote does not control programmed components (TV or video)	<ul style="list-style-type: none"> • Check that you have pressed the remote's Aux button before trying to operate the component. • Re-program and/or re-teach the component's commands into the remote.
The  symbol appears on the screen when you press a remote-control button	<ul style="list-style-type: none"> • The selected function is not permitted at the time the button is pressed.
The system does not respond to commands, or it behaves in an erratic way	<ul style="list-style-type: none"> • Unplug the system's power cord from the AC outlet, wait 30 seconds, then plug it back in.

Specifications

BDS 335/635 System	
Audio Section	
Frequency Response @1W	20Hz – 20kHz, ±0.5dB
Continuous average power, stereo mode	50 Watts per channel, 20Hz – 20kHz, @ <1% THD, both channels driven into 6 ohms
Input sensitivity/impedance (line inputs)	250mV/> 10kΩ
Subwoofer power	100 Watts
Signal-to-noise ratio (IHF-A)	–90 dB
FM tuner section	
Frequency range	87.5MHz – 108.0MHz (US and EU)
Usable sensitivity IHF	>14dBf
Signal-to-noise ratio (mono/stereo)	55dB/55dB
Distortion (mono/stereo)	0.3%/0.5%
Stereo separation	–40dB @ 1kHz
Image rejection	70dB
IF rejection	80dB
General	
Power requirement	200V-240V AC
Power consumption (BDS 335)	120W rated power
Power consumption (BDS 635)	150W rated power
Dimensions	400.2 mm (L) x 283.8 mm (W) x 78.5 mm (H)
Weight	3.56 kg (BDS 335), 3.72 kg (BDS 635)
THD/1kHz	DVD/CD: 0.1%
Supported disc formats	5-inch (12cm) or 3-inch (8cm)
Video section	
Television format	NTSC or PAL (selectable)
HDMI® version	With 3-D and 30/36-bit Deep Color
Video signal receiver	NTSC (USA) or PAL (EU)
Wi-Fi 2.4GHz	
Transmit Frequency	2412 MHz to 2472 MHz
Technology	IEEE 802.11 a/b/g/n (HT20/HT40)
Modulation type	DSSS, OFDM
Transmit power	17.4 dBm(e.i.r.p)
Wi-Fi 5GHz	
Transmit Frequency	5745 MHz to 5825 MHz
Technology	IEEE 802.11a/n(HT20/HT40)
Modulation type	DSSS and OFDM
Transmit power	13.13 dBm(e.i.r.p)
Bluetooth	
Transmit Frequency	2402 MHz to 2480 MHz
Technology	Bluetooth V2.1+EDR
Modulation type	GFSK, π/4 DQPSK, 8DPSK
Transmit power	8.5 dBm(e.i.r.p)



HARMAN International Industries, Incorporated
8500 Balboa Boulevard, Northridge, CA 91329 USA
www.harmankardon.com

Harman International Industries Inc.
EMEA Liaison Office, Herikerbergweg 35
1101 CN Amsterdam, The Netherlands

© 2015 HARMAN International Industries, Incorporated. All rights reserved.
Features, specifications and appearance are subject to change without notice.

Harman Kardon is a trademark of HARMAN International Industries, Incorporated, registered in the United States and/or other countries.

The Bluetooth® word mark and logos are registered trademarks owned by Bluetooth SIG, Inc. and any use of such marks by HARMAN International Industries, Incorporated is under license. Other trademarks and trade names are those of their respective owners.

The Wi-Fi CERTIFIED Logo is a certification mark of the Wi-Fi Alliance.

The Wi-Fi Protected Setup Identifier Mark is a mark of the Wi-Fi Alliance.

Manufactured under license from Dolby Laboratories. Dolby, Pro Logic, and the double-D symbol are trademarks of Dolby Laboratories.

DTS, DTS-HD, the Symbol, & DTS or DTS-HD and the Symbol together are registered trademarks of DTS, Inc. © DTS, Inc. All Rights Reserved.

DivX®, DivX Certified®, DivX Plus® HD and associated logos are trademarks of Rovi Corporation or its subsidiaries and are used under license.

DivX Certified® to play DivX® and DivX Plus® HD (H.264/MKV) video up to 1080p HD including premium content.

The terms HDMI, the HDMI logo, and High-Definition Multimedia Interface are trademarks or registered trademarks of HDMI Licensing LLC in the United States and other countries.

Blu-ray Disc™, Blu-ray™, Blu-ray 3D™, and the logos are trademarks of the Blue-ray Disc Association.

*AVCHD™ and the "AVCHD" logo are trademarks of Panasonic Corporation and Sony Corporation.

Java is a registered trademarks of Oracle and/or its affiliates.

Google and YouTube are trademarks of Google Inc.

CE 1588 

harman/kardon®
by HARMAN