

OLYMPUS®

**DIGITAL VOICE
RECORDER**

VN-733PC
VN-732PC
VN-731PC

USER MANUAL

Getting started

1

Recording

2

Playback

3

Menu

4

Use with a PC

5

Other information

6

Thank you for purchasing an Olympus digital voice recorder.
Please read these instructions for information about using the product
correctly and safely.

Keep the instructions handy for future reference.

To ensure successful recording, we recommend that you test the record
function and volume before use.

EN

Table of contents

Names of parts	4
Recorder.....	4
Display	5

1 Getting started

Setup	7
Inserting the battery.....	8
Turn the power ON.....	9
Setting the date/time.....	9
Selecting the mode.....	10
Portable USB cable.....	10
Inserting/removing a microSD card	11
Inserting a microSD card.....	11
Removing a microSD card.....	12
Preventing accidental operation	13
Setting HOLD mode.....	13
Releasing HOLD mode.....	13
Turning the power OFF	14
Turning the power OFF.....	14
Selecting folders and files	15
Using the Calendar Search function to search for a file.....	15

2 Recording

Recording	16
Basic recording procedure.....	16
Pausing/resuming recording.....	18
Quickly checking a recording.....	18
Monitoring while recording.....	18
Recording with an external microphone	20
Recording with an external microphone.....	20
Recording from another connected device	21
Recording audio from another device with this recorder.....	21
Changing the recording scene [Rec Scene]	23
Changing the recording scene.....	23

3 Playback

Playback	24
Basic playback procedure.....	24
Playback through the earphones.....	25
Fast-forwarding.....	25
Rewinding.....	26
Skipping to the beginning of a file.....	26
Changing the playback speed.....	29
A-B repeat playback.....	30
Index marks/temp marks	31
Writing an index mark/temp mark.....	31
Erasing an index mark/temp mark.....	31
Erasing files	32
Erasing files.....	32

4 Menu

Setting menu items	34
Basic operation.....	34
File menu [File Menu]	37
Preventing accidental file erasure [File Lock].....	37
Dividing a file [File Divide].....	37
Displaying file information [Property].....	37
Recording menu [Rec Menu]	38
Selecting the recording sensitivity [Rec Level].....	38
Setting the recording mode [Rec Mode].....	38
Reducing noise during recording [Low Cut Filter].....	39
Voice-activated recording function [VCVA].....	39
Voice sync recording function [V-Sync. Rec].....	40
Playback menu [Play Menu]	42
Reducing noise during playback [Noise Cancel].....	42
Adjusting low volume portions during playback [Voice Balancer].....	42
Emphasizing voice more clearly [Voice Filter].....	42
Selecting playback modes [Play Mode].....	42
Setting a skip space [Skip Space].....	43
LCD/Sound menu [LCD/Sound Menu]	45
Adjusting the contrast [Contrast].....	45
Setting the LED indicator light [LED].....	45
Turning beeping sound ON/OFF [Beep].....	45
Changing the display language [Language].....	45

Table of contents

Device menu [Device Menu]	46
Selecting the recording media [Memory Select]	46
Setting the date/time [Time & Date]	46
Selecting the mode [Mode Select]	47
Setting the USB connection [USB Settings]	47
Restoring the default settings [Reset Settings]	47
Formatting a recording media [Format]	48
Checking recording media information [Memory Info.]	49
Checking voice recorder information [System Info.]	49

5 Use with a PC

PC operating environment	50
PC connection/disconnection	51
Connecting the voice recorder to a PC	51
Disconnecting the voice recorder from a PC	52
Loading a file to a PC	53

6 Other information

Alarm message list	54
Troubleshooting	55
Accessories (optional)	56
Copyright and trademark information	57
Safety precautions	58
Specifications	62

Indications used in this manual

NOTE

Describes precautions and operations that should be absolutely avoided in using the voice recorder.

TIP

Describes useful information and hints that will help you get the most out of your voice recorder.



Indicates reference pages describing details or related information.

Names of parts

Recorder

Names of parts

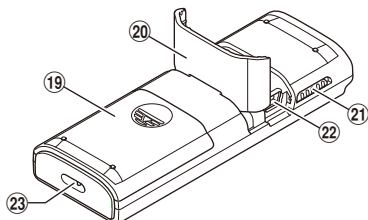
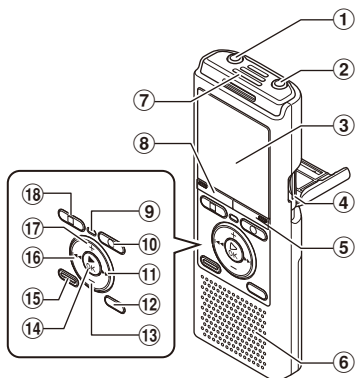

- ① **EAR (earphone) jack**
- ② **MIC (microphone) jack**
- ③ **Display**
- ④ **Card slot*¹**
- ⑤ **SCENE/CALENDAR button*¹**
SCENE button*²
- ⑥ **Built-in speaker**
- ⑦ **Built-in microphone**
- ⑧ **MENU button**
- ⑨ **LED indicator light (LED)**
- ⑩ **REC (record) (●) button**
- ⑪ **▶▶ button**
- ⑫ **FOLDER/INDEX button**
- ⑬ **– button**

- ⑭ **▶ OK button**
- ⑮ **ERASE button**
- ⑯ **◀◀ button**
- ⑰ **+ button**
- ⑱ **STOP (■) button**
- ⑲ **Battery cover**
- ⑳ **Card/USB connector cover**
(also used as stand)
- ㉑ **POWER/HOLD switch**
- ㉒ **USB connector**
- ㉓ **Strap hole**

* 1 VN-733PC and VN-732PC models only

* 2 VN-731PC model only

Display

Normal mode

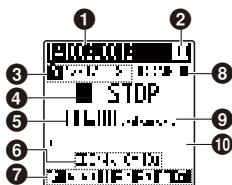

Simple mode

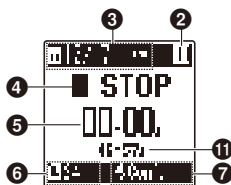

- 1** File name
- 2** Battery indicator
- 3** Folder indicator, Current file number in folder/Total number of recorded files in folder and file lock indicator

4 Voice recorder status indicator

- [RECORDING]: Recording indicator
- [PAUSE]: Recording pause indicator
- [STOP]: Stop indicator
- [PLAY]: Playback indicator
- [FAST PLAY]: Fast playback indicator
- [SLOW PLAY]: Slow playback indicator
- [FF]: Fast forward indicator
- [REWIND]: Fast rewind indicator

5 Elapsed recording time or playback time

6 Recording media indicator

- [MEM]: Internal memory
- [CARD]: microSD card^{*1}

Possible recording time remaining

7 Meanings of indicators shown in indicator display area

- [HL]: Rec Level
- [VCVA]: VCVA
- [SYNCR]: V-Sync. Rec^{*1}
- [LFCF]: Low Cut Filter
- [NCR]: Noise Cancel^{*2}
- [VB]: Voice Balancer^{*2}
- [VF]: Voice Filter^{*3}

- [PLAY MODE]: Play Mode

8 Recording format indicator

9 File length

10 Playback position bar indicator

11 Level meter or file length

* 1 VN-733PC and VN-732PC models only

* 2 VN-733PC model only

* 3 VN-732PC model only

Display

TIP

- Pressing and holding the **STOP** (■) button while the voice recorder is in stop mode displays the [Time & date] and [Remain] (amount of possible recording time remaining) settings. If the current date/time is set incorrectly, see “Setting the date/time [Time & Date]” (P.46).



Getting started

Setup

After unpacking the voice recorder, follow the steps below to have it ready for use.

Getting started **1**

Insert the battery

Getting started **2**

Turn the power ON

Getting started **3**

Setting the date/time

Set the voice recorder's clock for use with file management.

Getting started **4**

Selecting the mode

Select either normal mode or simple mode.

1

Setup

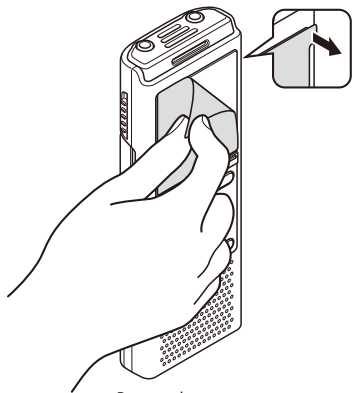

Remove the screen protector on the display.

Inserting the battery

1

Before using the voice recorder, insert the battery in the battery compartment of the voice recorder.

Setup

- 1 Slide open the battery cover while lightly pressing down on it.

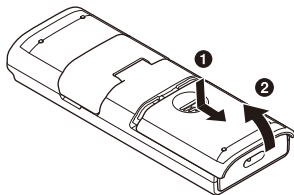

- 2 Insert a AAA battery, making sure its positive and negative terminals are placed correctly. Slide the battery cover completely closed.

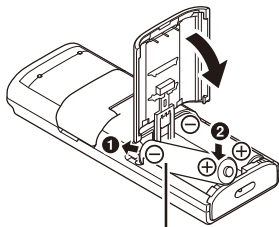

Insert the battery's negative terminal first

For users in Germany

Olympus has an agreement with the GRS (Joint Battery Disposal Association) in Germany to ensure environmentally-friendly battery disposal.

Battery indicator

As the battery loses its remaining charge, the battery indicator on the display changes as follows:



- [] indicates there is little remaining battery charge. Replace the battery with a fresh one. When the battery has run out, [] and **[Battery low]** appear, and operation stops.

Battery precautions

- The voice recorder does not support manganese batteries.
- Always turn power off before replacing the battery. Files may be damaged if the battery is removed while the voice recorder is recording or performing an operation such as erasing a file.
- When not using the voice recorder for an extended period, always remove the battery before storage.
- The continuous battery usage time will vary depending on the performance of the battery in use (e.g. P.63).

Turn the power ON

- 1 While the voice recorder is turned off, slide the **POWER/HOLD** switch in the direction of the arrow.

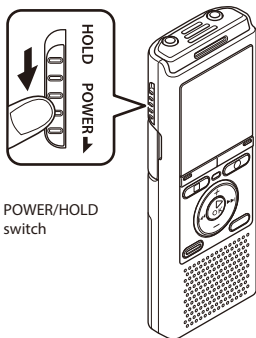

POWER/HOLD
switch

TIP

- When **[Language]** appears in the display after turning the power ON, press the **+/-** button to change the display language and press the **▶OK** button to finalize the setting.

Setting the date/time

- 1 Press the **▶▶|** or **|◀◀** button to select the item to set.

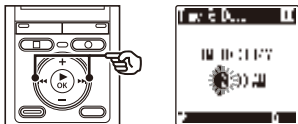

- 2 Press the **+/-** button to change the number.

- To change the setting of another item, press the **▶▶|** or **|◀◀** button to move the blinking cursor, then press the **+** or **-** button to change the number.

- 3 Press the **▶OK** button to finalize the setting.

TIP

- You can press the **▶OK** button during the setting procedure to set the items entered so far and start the clock.

Selecting the mode

- 1 Press the +/- button to change the mode.

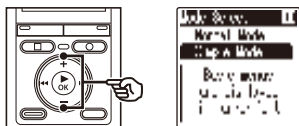

[Normal Mode]:

This is the standard mode in which all functions are available.

[Simple Mode]:

This mode lists frequently used functions. Displayed text becomes larger for easier viewing.

- 2 Press the ►OK button to finalize the setting.

TIP

The mode can be switched even after setting. "Selecting the mode [Mode Select]" (☞ P.47)

Portable USB cable

The provided Portable USB cable can be attached to the strap hole to carry it around.

! VN-733PC and VN-732PC models only

- 1 Remove a strap from the Portable USB cable.

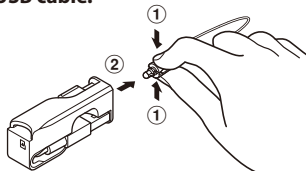

- Pull out the strap while pressing the connector part.

- 2 Attach a strap to the voice recorder.

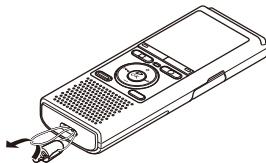

- 3 Attach a strap to the Portable USB cable.

TIP

- The Portable USB cable must be removed from strap whenever using a USB connection (☞ P.51).

Inserting/removing a microSD card

The voice recorder has its own internal memory, and also supports standard microSD cards (microSD, microSDHC) sold separately.

! VN-733PC and VN-732PC models only

Inserting a microSD card

- 1** While the voice recorder is in stop mode, open the card/USB connector cover.

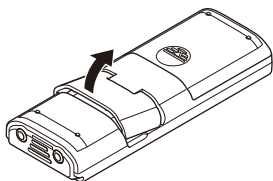

- 2** Insert a microSD card, making sure it is placed correctly as shown.

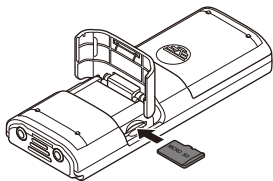

- Insert the microSD card straight, avoiding crooked insertion.
- Inserting a microSD card the wrong way or crookedly could damage its contact surface or cause it to jam in the slot.
- A microSD card not inserted fully (until it clicks into place) might not record data.

- 3** Close the card/USB connector cover.

- The recording media selection screen appears after a microSD card has been inserted.

- 4** To record onto the microSD card, press the +/– button and select [Yes].

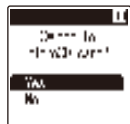
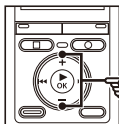

- 5** Press the ► OK button to finalize the setting.

TIP

- You can also select the internal memory as the recording media (☞ P.46).

NOTE

- The voice recorder may not be able to recognize a microSD card formatted (initialized) for a PC or other device. Before using a microSD card, always initialize it on the voice recorder (☞ P.48).

Inserting/removing a microSD card

Removing a microSD card

1

Inserting/removing a microSD card

- 1 While the voice recorder is in stop mode, open the card/USB connector cover.

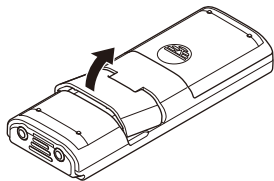

- 2 Release the microSD card by pressing it inward, then letting it slowly return.

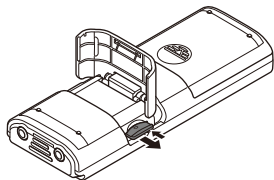

- The microSD card moves outward and stops. Pull the microSD card out with your fingertips.
 - **[Internal memory selected]** is displayed after removing a microSD card if **[Memory Select]** was set to **[microSD card]**.
- 3 Close the card/USB connector cover.

NOTE

- microSD cards may pop out forcefully on removal if you flick or release your finger too quickly after pressing the card in.
- Depending on the card's manufacturer and type, some microSD cards and microSDHC cards may not be fully compatible with the voice recorder and not be recognized properly.
- For microSD card compatibility under Olympus verification, please contact our customer support at:

<http://www.olympus-europa.com>

Note that our customer support will provide information on microSD card manufacturers and card types for which Olympus has verified operation, but will not guarantee its performance. Also note that some cards may no longer be recognized correctly by the voice recorder in case card manufacturer changes card specifications.

- Read the operating instructions provided with the card when using a microSD card.
- If a microSD card is not recognized by the voice recorder, try moving and reinserting the card to have the voice recorder attempt recognition again.
- Processing speed may be low for some microSD card types. Processing performance may also be reduced by writing or deleting data repeatedly from a microSD card. In this case, reinitialize the card (see P.48).

Preventing accidental operation

Setting the voice recorder to HOLD mode maintains the current operation and disables button operations. HOLD mode is a handy feature for preventing unintentional operation from accidental button presses when the voice recorder is carried in a bag or pocket. It is also useful for preventing the voice recorder being accidentally stopped during recording.

Setting HOLD mode

- 1 Slide the **POWER/HOLD** switch to the **[HOLD]** position.

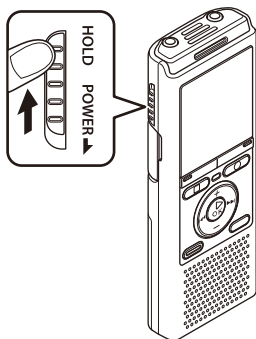

Releasing HOLD mode

- 1 Slide the **POWER/HOLD** switch to position **A** shown below.

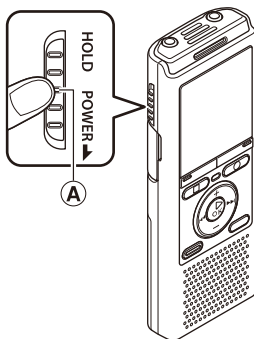

- **[Hold]** appears in the display, and the recorder enters HOLD mode.

NOTE

- When any button is pressed during HOLD mode, **[Hold]** appears in the display for 2 seconds. No other operation is performed.
- Setting HOLD mode during voice recorder playback (or recording) continues the playback (or recording) operation and prevents any other operation from being performed (the voice recorder stops when playback ends, or recording stops when there is no more available memory).

Turning the power OFF

Turning the power OFF

1

Existing data, menu settings and the clock setting are saved when the power is turned OFF.

- 1 Slide the **POWER/HOLD** switch in the direction of the arrow for at least half a second.

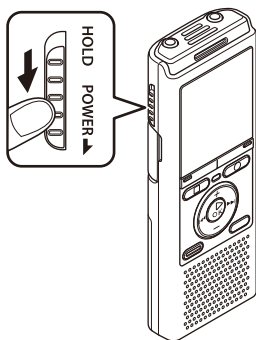

- The playback stop position at power OFF is stored in the memory.

TIP

- Turning the power OFF whenever the voice recorder is not in use minimizes battery consumption.

Power Save mode

When the voice recorder has been stopped for at least 5 minutes after power ON, the display disappears and the voice recorder automatically enters the Power Save mode.

- Pressing any button releases the Power Save mode.

Selecting folders and files

The recorder provides five folders, [0], [1], [2], [3] and [4]. Each folder can store up to 200 files.

- 1 Press the **FOLDER/INDEX** button while the voice recorder is in stop mode.

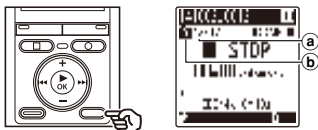

- (a) File number
- (b) Folder indicator

- The folder changes each time you press the **FOLDER/INDEX** button.

- 2 Press the **▶▶▶** or **◀◀◀** button to select the desired file.

- Immediately after a file is selected, the recorded date and time is displayed for 2 seconds only.

Using the Calendar Search function to search for a file

You can search for voice files by specifying a recording date. If you have forgotten in which folder a file has been saved, this feature lets you access it quickly by entering its recording date.

! VN-733PC and VN-732PC models only

- 1 Press the **SCENE/CALENDAR** button while the voice recorder is in stop mode.

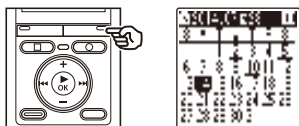

- 2 Press the **+/-**, **▶▶▶** or **◀◀◀** button to select the desired date.

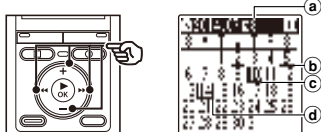

- (a) Number of files saved (recorded) on selected date
- (b) Date file was recorded
- (c) Selected date
- (d) Today's date

- Dates on which files were saved are underlined.

▶▶▶ or **◀◀◀** button:

Move to the previous/next date. Press and hold to skip to the next date on which a file was recorded.

+/- button:

Move to the previous/next week.

- 3 Press the **▶OK** button.

- 4 Press the **+/-** button to select the desired file.

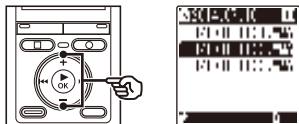

Recording

Recording

The voice recorder has five folders ([] to []) in which recorded files can be saved. These folders provide a handy way to sort recordings into separate categories (such as business and leisure).

2

Recording

Basic recording procedure

- 1 **Select the folder to save the recording in (P.15).**

- Each new voice recording file is saved in the selected folder.

- 2 **Point the built-in microphone in the direction of the sound to record.**

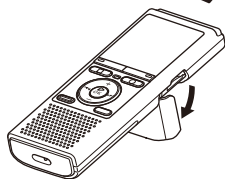

- You can use the card/USB connector cover as a stand when needed.

- 3 **Press the REC (●) button to start recording.**

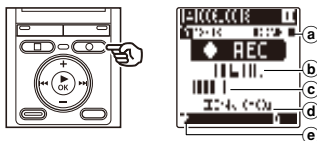

- a Rec mode
- b Elapsed recording time
- c Level meter (changes according to recording volume and recording function setting)
- d Remaining possible recording time
- e Recording level
 - The LED indicator light lights.

- 4 **Press the STOP (■) button when you want to stop recording.**

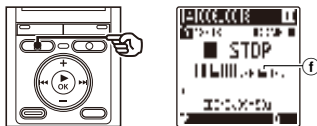

- f File length

Sound files recorded with the voice recorder are automatically given a file name in the format below.

141001_0001.WMA

①

②

③

① Date recorded

Indicates the year, month and day the recording was made.

② File number

Appended file numbers are consecutive regardless of whether the recording media has been switched.

③ Extension

A file extension indicating the recording format the file was recorded in by the voice recorder.

- MP3 format: “.MP3”*
- WMA format: “.WMA”

* VN-733PC and VN-732PC models only

TIP

- [Rec Mode] must be set with the voice recorder stopped (P.38).

NOTE

- To prevent the beginning of the recording being cut off, start recording after the LED indicator light has lit or recording indicator has appeared in the display.
- When the remaining possible recording time is 60 seconds, the LED indicator light starts flashing. It flashes more rapidly as the remaining time decreases (at the 30- and 10-second points).
- When [Folder full] appears, no more recording can be done. To record more, you will need to select a different folder or delete unneeded files (P.32).
- If [Memory full] appears, the voice recorder has no more available memory space. You will need to delete unneeded files to record more (P.32).
- It's recommended to initialize the recording media before making an important recording.
- Processing performance may be reduced when data has been repeatedly written to or deleted from the recording media. Please initialize the recording media in this case (P.48).

VN-733PC and VN-732PC models only:

- When using a microSD card in the voice recorder, be sure the desired recording media setting ([Internal memory] or [microSD card]) has been selected (P.46).

Pausing/resuming recording

- 1 Press the **REC (●)** button during recording.

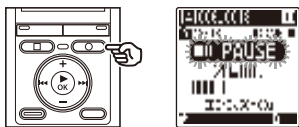

- Recording pauses, and the blinking message **[PAUSE]** appears in the display.
- Recording is stopped automatically after being paused for at least 60 minutes.

- 2 Press the **REC (●)** button again while recording is paused.

- Recording resumes from the position it was paused at.

Quickly checking a recording

- 1 Press the **▶OK** button during recording.

Monitoring while recording

You can monitor the recording as you are making it by listening on the earphone plugged into the voice recorder's **EAR** jack. Use the **+/-** button to adjust the recording monitor volume.

- The earphones are optional.

- 1 **Connect the earphones to the voice recorder's EAR jack.**

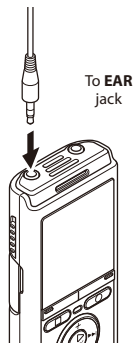

- Changing the volume will not affect the recording level.

NOTE

- To avoid unpleasantly loud sound, set the volume to **[00]** before plugging in the earphone.
- To prevent feedback, do not place the earphone near the microphone while recording.

Recording settings

Various recording settings are available, letting you tailor recording to different recording conditions.

[Rec Level] (<small>EN</small> P.38)	Sets the recording sensitivity.
[Rec Mode] (<small>EN</small> P.38)	Sets the recording sound quality.
[Low Cut Filter] (<small>EN</small> P.39)	Reduces humming sounds from equipment such as air-conditioners or projectors.
[VCVA] (<small>EN</small> P.39)	Sets the trigger level for voice-activated recording (VCVA).
[V-Sync. Rec] [*] (<small>EN</small> P.40)	Sets the trigger level for voice-synchronized recording.
[Rec Scene] (<small>EN</small> P.23)	Used to select one of multiple preregistered templates of recording settings. When selected, each template enters several settings tailored to a particular recording location or condition all in a single operation.

* VN-733PC and VN-732PC models only

Recording with an external microphone

Recording with an external microphone

You can record audio input using an external microphone or other device connected to the voice recorder's **MIC** jack. Do not plug or unplug devices into voice recorder jacks while recording.

2

Recording with an external microphone

- 1 **Connect an external microphone to the voice recorder's MIC jack.**

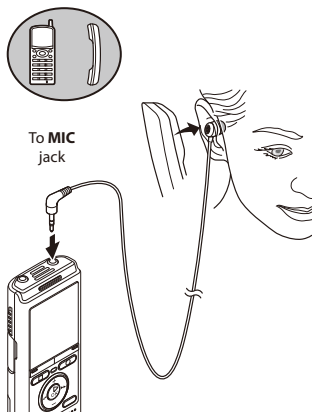

Example: TP8 telephone pickup microphone (optional)

- 2 **Press the REC (●) button to start recording.**

TIP

- When using the phone microphone (Telephone pickup TP8), set **[Rec Scene]** to **[Telephone Rec]**. This allows you to record conversations on mobile and landline telephones clearly (☞ P.23).
- See “**Accessories (optional)**” (☞ P.56) for the compatible external microphones.

NOTE

- Connecting an external microphone to the voice recorder's **MIC** jack disables the built-in microphone.
- Microphones with plug-in power supplies can be used.
- When **[Rec Mode]** is set to stereo, recording with an external mono microphone records on the left channel only (☞ P.38).
- When **[Rec Mode]** is set to mono, only the input from the left channel microphone is recorded when using an external stereo microphone (☞ P.38).

Recording from another connected device

Recording audio from another device with this recorder

Audio can be recorded when you have connected the audio output terminal (earphone jack) of another device and the **MIC** jack of the recorder using the connecting cord KA333 (optional) for duplication.

- 1 While the voice recorder is in stop mode, press and hold the SCENE/ CALENDAR button.**

For VN-731PC:

Press the **SCENE** button while the voice recorder is in stop mode.

- 2 Press the +/- button to select [Duplication (Auto Divide)] or [Duplication (Timer)].**

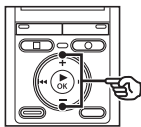

[Duplication (Auto Divide)]:

Files are automatically divided into each song when recording.

[Duplication (Timer)]:

Recording is saved to one file and stops when the previously set time has been reached.

- 3 Press the ►OK button.**

- 4 Press the +/- button to change the setting.**

When **[Duplication (Auto Divide)]** was selected:

[Cassette]:

Suitable for sound sources with a lot of noise such as a cassette tape dubbed from a CD or record.

[CD]:

Suitable for sound sources with little noise such as a CD.

When **[Duplication (Timer)]** was selected:

The time used for duplication can be selected from among **[Off]**, **[30 min.]**, **[60 min.]**, **[90 min.]** and **[120 min.]**.

- 5 Press the ►OK button to finalize the setting.**

- 6 Press the STOP (■) button to exit the menu screen.**

Recording from another connected device

Recording audio from another device with this recorder

2

Recording from another connected device

- 7 Connect the voice recorder with another device using the connecting cord KA333.

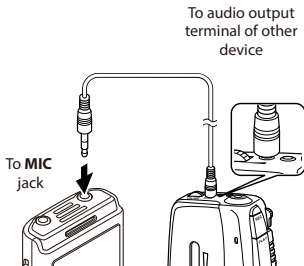

- 8 Press the REC (●) button to start recording.
- 9 Start playback on the other device.
- 10 When duplication is completed, press the STOP (■) button to stop recording.

- When [Duplication (Timer)] was selected, recording automatically stops when the set time is reached.

NOTE

- Do not plug or unplug devices into voice recorder jacks while recording.
- Perform adjustment of the recording level on the other device.
- To ensure successful recording, we recommend that you test the record function and volume before use.
- In [Duplication (Auto Divide)], an original recording will be copied to separate files divided into each song by the signal level or the noise level of a silent part. When the signal level is too low or the noise is significant, recording and division may not be performed properly. In that case, select [Duplication (Timer)] and manually start and stop recording.
- If the connecting cord is not connected when [Duplication] is selected, the message [Connect an audio cable to the mic jack] is displayed.

Changing the recording scene [Rec Scene]

Changing the recording scene

The voice recorder has preregistered templates of optimum settings tailored to various recording applications such as conference and dictation. When selecting one of these templates you can enter several settings recommended for your recording application all in a single operation.

- 1 While the voice recorder is in stop mode, press and hold the SCENE/CALENDAR button.**

For VN-731PC:

Press the **SCENE** button while the voice recorder is in stop mode.



- 2 Press the +/- button to select the desired recording application.**

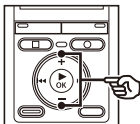

- You can choose from [Dictation], [Meeting], [Conference], [Duplication (Auto Divide)] (☞ P.21), [Duplication (Timer)] (☞ P.21), [Telephone Rec] (☞ P.20), [DNS] or [Off].

TIP

- [Rec Scene] also can be set from the menu (☞ P.34).

NOTE

- Recording menu settings cannot be changed when a [Rec Scene] selection has been made. To use these functions, you must select [Off] for the [Rec Scene] setting.
- During simple mode, [Rec Scene] cannot be set to [Off].

Playback

Playback

In addition to files recorded by the voice recorder, you can also play files in MP3* and WMA format transferred from a PC.

*VN-733PC and VN-732PC models only

Basic playback procedure

3

Playback

1 Select the file to play from the folder containing it (see P.15).

2 Press the ►OK button to start playback.

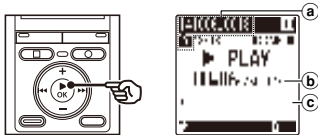

- a File name and folder indicator
- b Elapsed playback time/File length
- c Playback position bar indicator

3 Press the +/- button to adjust the volume to the desired level.

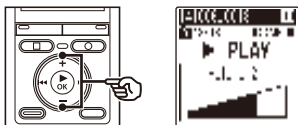

- The volume can be adjusted to a setting between [00] to [30]. The higher the number, the louder the volume.

4 Press the STOP (■) button to stop playback.

- The file being played stops right away. The resume function automatically stores the playback stop position in memory. The position is retained even if the power is turned OFF. The next time the power is turned ON, playback can be resumed from the stop position stored in the memory.

Playback through the earphones

You can connect the earphones to the voice recorder's **EAR** jack and listen to playback through them.

- 1 **Connect the earphones to the voice recorder's EAR jack.**

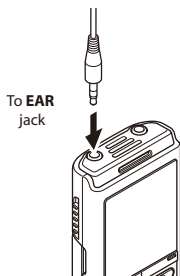

- 2 **Press the ►OK button to start playback.**

TIP

- There will be no sound from the speaker when the earphones are connected.

NOTE

- To avoid unpleasantly loud sound, set the volume to [00] before plugging in the earphone.
- Avoid excessive volume when listening to playback through the earphones. It may cause hearing damage or loss.

Fast-forwarding

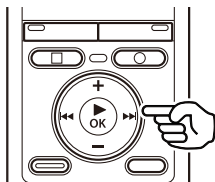

Fast-forwarding while the voice recorder is in stop mode

- 1 **With the voice recorder stopped, press and hold the ►► button.**

- Fast-forwarding stops when you release the ►► button. Press the ►OK button to start playback from the current position.

Fast-forwarding during playback

- 1 **Press and hold the ►► button during playback.**

- Playback starts from the current position when you release the ►► button.
- If an index mark or temp mark in the file is reached, fast-forwarding stops at the mark (⌂ P.31).
- Fast-forwarding stops when the end of the file is reached. Press and hold the ►► button again to fast-forward from the beginning of the next file.

Rewinding

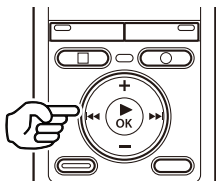

Rewinding while the voice recorder is in stop mode

- 1 With the voice recorder stopped, press and hold the **◀◀** button.

- Rewinding stops when you release the **◀◀** button. Press the **▶ OK** button to start playback from the current position.

Rewinding during playback

- 1 Press and hold the **◀◀** button during playback.
- Playback starts from the current position when you release the **◀◀** button.
 - If an index mark or temp mark in the file is reached, reached, rewinding stops at the mark (P.31).
 - Rewinding stops when the beginning of the file is reached. Press and hold the **◀◀** button again to rewind from the end of the previous file.

Skipping to the beginning of a file



Skipping to the beginning of the next file

- 1 Press the **▶▶** button while the voice recorder is in stop mode, or during playback.

Skipping to the beginning of the current file

- 1 Press the **◀◀** button while the voice recorder is in stop mode, or during playback.

Skipping to the beginning of the previous file

- 1 Press the **◀◀** button when the playback position is the beginning of the file.
- To skip to the beginning of the previous file during playback, press the **◀◀** button twice consecutively.

NOTE

- If an index mark or temp mark is reached when skipping to the beginning of a file during playback, playback starts from the position of the mark. When skipping to the beginning of a file while the voice recorder is in stop mode, the mark is ignored (E38 P.31).
- If a setting other than **[File Skip]** is set for **[Skip Space]**, playback starts after the set amount of time has been skipped backwards or forwards. Playback does not skip to the beginning of the file.

Music files

If a music file transferred to the voice recorder is unplayable, check that its sampling rate and bit rate values are within the supported ranges. The sampling rate and bit rate combinations supported for music file playback by the voice recorder are shown below.

File format	Sampling rate	Bit rate
MP3 format*	MPEG 1 Layer 3: 32 kHz, 44.1 kHz, 48 kHz MPEG 2 Layer 3: 16 kHz, 22.05 kHz, 24 kHz	8 to 320 kbps
WMA format	8 kHz, 11 kHz, 16 kHz, 22 kHz, 32 kHz, 44.1 kHz, 48 kHz	5 to 320 kbps

- * VN-733PC and VN-732PC models only
- MP3 files with variable bit rates (bit rates converted variably in a single file) may not play normally.
- Even if the file formats is compatible for playback on this recorder, the recorder does not support every encoder.

Playback settings

You can select various file playback methods tailored to different applications and tastes.

[Noise Cancel] ^{*1} (<small>ESP</small> P.42)	A setting that makes recorded voices more discernable when muffled by projector noise or similar sounds.
[Voice Balancer] ^{*1} (<small>ESP</small> P.42)	Compensates low-volume portions of recorded audio files during playback.
[Voice Filter] ^{*2} (<small>ESP</small> P.42)	Cuts low- and high-frequency components, emphasizing voices for greater clarity.
[Play Mode] (<small>ESP</small> P.42)	Selecting from among three playback modes.
[Skip Space] (<small>ESP</small> P.43)	A handy function for quickly moving the playback position, and playing short segments repeatedly.

* 1 VN-733PC model only

* 2 VN-732PC model only

Changing the playback speed

Changing the playback speed is handy for speeding up conference presentations, or for slowing down parts difficult to discern when learning a language.

1 Press the ►OK button during playback.

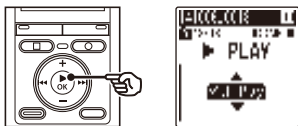

NOTE

- Altered playback speed settings are retained even after power OFF.
- Changing the playback speed will make the battery deplete more quickly.
- The function below cannot be used when changing the playback speed.
 - [Noise Cancel] (E87 P.42)

2 Press the +/- button.

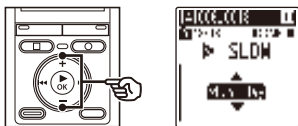

Fast playback restrictions

Depending on their sampling frequency and bit rate, some files may not play normally. In this case, you will need to reduce the playback speed.

- Adjust the playback speed.

3 Press the ►OK button.

TIP

- When changing the playback speed, playback operations such as stopping playback, skipping to the beginning of a file, and writing index marks/temp marks are the same as during standard playback.

A-B repeat playback

The voice recorder has a function that lets you repeat the playback of a portion (segment) of the file being played.

- 1 Select a file for A-B repeat playback, and start playback.

- 2 Press the REC (●) button when playback reaches the desired start position for A-B repeat playback.

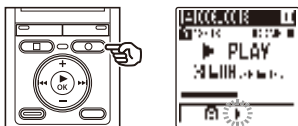

TIP

- You can change the playback speed (P.29), and fast-forward/rewind (P.25, P.26) when the [▶] indicator is blinking.
- If playback reaches the end of the file when the [▶] indicator is blinking, the end of the file is treated as the segment end position, and repeat playback starts.

- 3 Press the REC (●) button again when playback reaches the desired end position for A-B repeat playback.

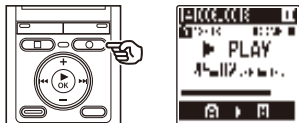

- Segment A-B is set, and A-B repeat playback starts.

- 4 Press the STOP (■) button.

- Playback stops. The playback segment specified for this function is retained.

NOTE

- When an index or temp mark is written or erased during A-B repeat playback, A-B repeat playback is canceled and the voice recorder returns to normal playback.

Canceling A-B repeat playback

- 1 Press the STOP (■) button while the voice recorder is in stop mode.

NOTE

- When the REC (●) button is pressed during A-B repeat playback the setting is canceled without disrupting playback.

Index marks/temp marks

Writing an index mark or temp mark in a file enables you to quickly access desired position in the file with the same operations used for fast-forwarding, rewinding or skipping to the start of a file. Index marks can only be written in files created with Olympus voice recorders. For files created with other devices, you can temporarily store desired positions in the memory using temp marks.

Writing an index mark/temp mark

- 1 When the desired position has been reached during recording or playback, press the **FOLDER/INDEX** button to write an index or temp mark.

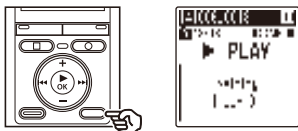

NOTE

- Temp marks are temporary markings. They are automatically erased when you select a different file, transfer the file to a PC, or move the file on a PC.
- You can write up to 99 index marks/temp marks in a single file. The message **[No more can be set]** appears if you attempt to write more than 99 marks.
- You cannot write or erase index marks/temp marks in files that have been locked by the file lock function (P.37).

Erasing an index mark/temp mark

- 1 Select a file that contains index mark/temp mark you want to erase and start playback.
- 2 Use the **▶▶▶** or **◀◀◀** button to select the index mark/temp mark you want to erase.

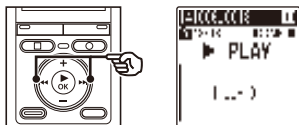

- 3 When the number of the index mark/temp mark to erase is being shown (for about 2 seconds) in the display, press the **ERASE** button.
- Any subsequent index marks/temp marks in the file are automatically renumbered.

Erasing files

This section describes how to erase files from the folder all at once or individually.

Erasing files

3

Erasing files

- 1 Select the file you want to erase (see P.15).

- 2 Press the ERASE button while the voice recorder is in stop mode.

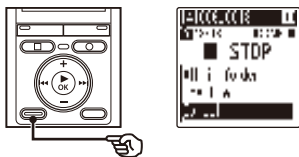

- The voice recorder returns to the stop mode if no operation is performed for 8 seconds.

- 3 Press the +/- button to select [All in folder] or [One file].

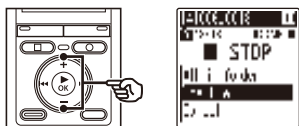

[All in folder]:

Erases all the files saved in the same folder as the selected file.

[One file]:

Erases only the selected file.

- 4 Press the ► OK button.

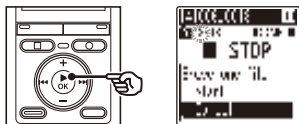

- 5 Press the + button to select [Start].

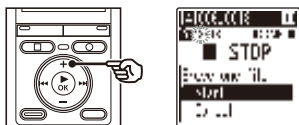

- 6 Press the ► OK button.

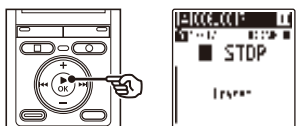

- **[Erasing!]** appears in the display, and the erasing process starts. **[Erased]** appears when the process has finished.

NOTE

- Files cannot be restored after being erased, so please check carefully before erasing a file.
- You cannot delete folders through the recorder.
- Before erasing a file, replace the battery to ensure it will not run out before the process has finished. Erasing processes can take over 10 seconds to complete. To prevent the risk of damage to data, never attempt to perform any of the following processes before an erasing process has finished :
 - ① Removing the battery
 - ② Removing the microSD card (if the recording media has been set to **[microSD card]**) (VN-733PC and VN-732PC models only).

VN-733PC and VN-732PC models only:

- When there is a microSD in the voice recorder, be sure to check whether the recording media being erased is **[Internal memory]** or **[microSD card]** (P.46).

Setting menu items

Basic operation

In normal mode, menu items are arranged by tabs, letting you quickly set desired items by selecting a tab and then moving to the desired item within the tab. Follow the steps below to set a menu item.

4

Setting menu items

- 1** During recording/playback or while the voice recorder is in stop mode, press the MENU button.

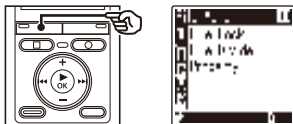

- Go to Step 2 when in normal mode, and go to Step 4 when in simple mode.

TIP

- Some menus contain items that can be set during recording/playback (☞ P.36).

- 2** Press the +/- button to select the tab containing the item you want to set.

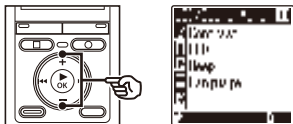

- Moving the cursor from one tab to another switches the displayed menu screen.

- 3** Press the ►OK button to move the cursor to the desired setting item.

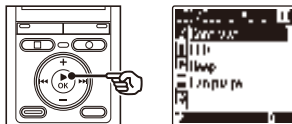

- You can also use the ►| button to perform this operation.

- 4** Press the +/- button to select the desired setting item.

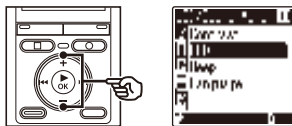

Setting menu items

Basic operation

5 Press the ►OK button.

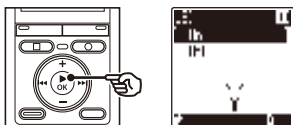

- The setting of the selected item is displayed.
- You can also use the ►► button to perform this operation.

6 Press the +/– button to change the setting.

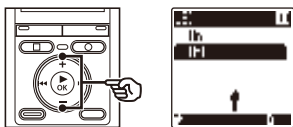

7 Press the ►OK button to finalize the setting.

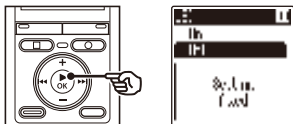

- A message indicating the setting has been entered appears.
- You can cancel the setting and return to the previous screen by pressing the ◀◀ button instead of the ►OK button.

8 Press the STOP (■) button to exit the menu screen.

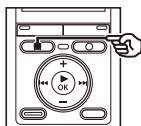

- When the menu screen is displayed during recording or playback, press the **MENU** button to return to the previous screen without ending recording/playback.

NOTE

- For menu settings done while the voice recorder is in stop mode, the voice recorder exits the menu and returns to the stopped mode if no operation is performed for 3 minutes. The selected setting item is not changed in this case.
- For menu settings done during recording/playback, the voice recorder exits the menu if no operation is performed for 8 seconds.

Setting menu items

Basic operation

Menu items that can be set during recording	Menu items that can be set during Playback	
	Normal mode only	Normal mode
[Rec Level] [VCVA] [Low Cut Filter] [LED]	[Property] [Play Mode] [Noise Cancel] ^{*1} [Skip Space] [Voice Balancer] ^{*1} [LED] [Voice Filter] ^{*2}	[Skip Space]

* 1 VN-733PC model only

* 2 VN-732PC model only

Menu items that can be set during simple mode
[Rec Scene] [Skip Space] [Memory Select] ^{*1} [Time & Date] [Beep] [USB Settings] ^{*2} [Mode Select] [Language]

* 1 VN-733PC and VN-732PC models only

* 2 VN-733PC model only

File menu [File Menu]

Preventing accidental file erasure [File Lock]

The file lock feature lets you lock important files to prevent them being accidentally erased. Once locked, a file is not erased even if the operation for erasing all the files in its folder is performed (☞ P.32).

1 Select the file you want to lock (☞ P.15).

[Lock]:
File is locked.

[Unlock]:
File lock is canceled.

Dividing a file [File Divide]

Large files or files with long recording times can be divided for easier management and editing.

! VN-733PC and VN-732PC models only

NOTE

Only MP3-format file recorded on the voice recorder can be divided.

1 Play the file to divide, and stop playback at the desired division point.

2 Select [File Divide] from the menu on the [File Menu].

3 Press the + button to select [Start].

4 Press the ► OK button.

- [Dividing!] appears in the display, and the file dividing process starts. [File divide completed] appears when the process has finished.

TIP

- After dividing a file, the first half of the file is given the name "File name_1" and the second half "File name_2".

NOTE

- Files cannot be divided if there are 199 files in the folder.
- Locked files cannot be divided.
- It may not be possible to divide some MP3 file with extremely short recording times.
- To prevent the risk of data damage, never remove the battery while dividing a file.

Displaying file information [Property]

You can display the information of a file from a menu screen.

1 Press the +/- button to switch the screen.

- Information is displayed for the items [Name], [Date], [Size] and [Bit Rate].

Recording menu [Rec Menu]

Selecting the recording sensitivity [Rec Level]

You can change the recording level (sensitivity) as needed for your recording application.

[High]:

Suited to recording lectures, large conferences and other applications with distant or quiet sound sources.

[Low]:

Suited to recording dictation.

TIP

- To record the speaker's voice clearly, set **[Rec Level]** to **[Low]**, and place the voice recorder's built-in microphone near the speaker's mouth (5 to 10 cm away).

Setting the recording mode [Rec Mode]

You can prioritize sound quality or recording time. Select the recording mode that best matches your recording application.

[MP3 192 kbps]**¹

[MP3 128 kbps]**¹

[WMA 64 kbps]**²

[WMA 32 kbps mono]**³

[WMA 5 kbps mono]**³

- *¹ VN-733PC and VN-732PC models only
- *² VN-731PC model only
- *³ Mono recording

TIP

- Sound quality increases as the recording rate value increases.
- Setting a higher recording rate increases file size. Check that you have enough remaining memory before recording.
- To record conferences and presentations clearly, it is recommended to set **[Rec Mode]** setting to **[MP3 128kbps]**^{*} or above.
^{*} For VN-731PC, set **[WMA 64 kbps]**.

NOTE

- When **[Rec Mode]** is set to stereo, recording with a connected an external mono microphone records on the left channel only.

Recording menu [Rec Menu]

Reducing noise during recording [Low Cut Filter]

The voice recorder's low cut filter function lets you make recordings that reduce humming sounds from air-conditioners or low-frequency sounds from equipment such as projectors.

- [On]:**
Turns the low cut filter on.
- [Off]:**
Turns the low cut filter off.

Voice-activated recording function [VCVA]

The voice-activated recording function (VCVA) automatically starts recording when a sound louder than a preset voice activation level is detected, and automatically pauses recording when the sound volume level falls. Use this function to automatically omit unneeded quiet segments when recording (such as long silences during conferences), saving memory.

- [On]:**
Turns VCVA on. You can adjust the voice activation level used for VCVA.
- [Off]:**
Turns VCVA off. Restores standard recording.

Adjusting the voice activation level for voice-activated recording

- 1 Press the REC (●) button to start recording.**
 - Recording pauses automatically about 1 second after the input sound becomes quieter than the set activation sensitivity. The blinking message **[Standby]** appears in the display. The LED indicator light becomes lit when recording is activated and flashes when recording is paused.
- 2 Press the ►► or ◀◀ button to adjust the voice activation level.**

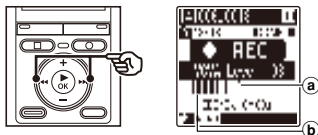

- Voice activation level (moves left/right to match set level)
 - Level meter (changes in proportion to recording sound volume)
- The setting can be adjusted to between **[01]** and **[15]**.

TIP

- Increasing the setting number increases the VCVA activation sensitivity, enabling quieter sounds to activate the start of recording.
- Adjust the VCVA voice activation level to suit the recording conditions (to cope with high levels of surrounding noise or the like).
- To avoid recording mistake, it's recommended to perform a test recording beforehand to adjust the voice activation level.

NOTE

- The following function is disabled when using the [VCVA] function:
 - [Rec Scene] (P.23)
 - [V-Sync. Rec]

**Voice sync recording function
[V-Sync. Rec]**

The voice sync recording function automatically starts recording when a sound louder than a preset voice sync recording level (detection level) is detected, and automatically stops recording when the sound volume level decreases. When copying music from another device connected to the voice recorder, use the voice sync recording function to detect the silent intervals between music tracks and save each track as a separate file.

**VN-733PC and VN-732PC
models only**

[1 sec.], [2 sec.], [3 sec.], [5 sec.]:

Set the detection time. The voice recorder enters standby mode when the input (recording level) is below the preset level for at least the set detection time.

[Off]:

Recording is done normally.

Adjusting the voice sync level for voice sync recording

- 1 Press the **REC** (●) button to prepare for recording.
- 2 Press the **▶▶** or **◀◀** button to adjust the voice sync level.

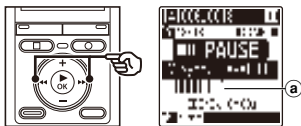

- a Voice sync level (moves left/right to match set level)
- The voice sync level can be adjusted to a setting between **[01]** and **[15]**.
 - Increasing the setting number increases the activation sensitivity, enabling quieter sounds to activate the start of recording.

- 3 Press the **REC** (●) button again.

- The blinking message **[Standby]** appears in the display, and the LED indicator light flashes.
- Recording starts automatically if the input is louder than the voice sync level.

TIP

- The voice recorder automatically ends recording and returns to recording standby mode when the input sound has been below the set detection time. Each time the voice recorder enters standby mode, the current file is closed. Recording continues in a new file the next time sound is detected.
- Press the **STOP** (■) button to end a voice sync recording session.

NOTE

- The following function is disabled when using the **[V-Sync. Rec]** function:
 - **[Rec Scene]** (P.23)
 - **[VCVA]** (P.39)

Playback menu [Play Menu]

Reducing noise during playback [Noise Cancel]

Use the **[Noise Cancel]** function to reduce noise when a recorded voice is difficult to discern.

VN-733PC model only

[High][Low]:

Reduces surrounding noise, producing higher sound-quality playback.

[Off]:

The noise cancel function is disabled.

Adjusting low volume portions during playback [Voice Balancer]

The **[Voice Balancer]** function adjusts low-volume portions of recorded audio files to make them louder.

Use it to make quiet parts of conversations or other recorded audio louder and clearer.

VN-733PC model only

[On]:

Adjusts low-volume portions of audio files during playback, making them louder.

[Off]:

The voice balancer function is disabled.

NOTE

- Using the **[Voice Balancer]** function will make the battery deplete more quickly.

Emphasizing voice more clearly [Voice Filter]

During normal playback or fast/slow playback, the voice filter function cuts low- and high-frequency range tone and emphasizes voices, making them more clearly audible.

VN-732PC model only

[On]:

Turns on the voice filter function.

[Off]:

Turns the voice filter function off.

NOTE

- Using the **[Voice Filter]** function will make the battery deplete more quickly.

Selecting playback modes [Play Mode]

Several playback modes are available for different listening styles.

1 Press the **+/-** button to select **[Playback range]** or **[Repeat]**.

[Playback range]:

Lets you specify a range of files for playback.

Playback menu [Play Menu]

[Repeat]:

Repeatedly plays the files in the set range.

2 Press the +/- button select a setting.

When [Playback range] was selected:

[File]:

Stops playback after the current file has been played.

[Folder]:

Plays all the files in the current folder consecutively, stopping playback after the last file in the folder is played.

When [Repeat] was selected:

[On]:

The files in the specified playback range are played repeatedly.

[Off]:

Cancels repeat playback.

NOTE

- When [Playback range] is set to [File], [End] blinks in the display for 2 seconds after the last file in the folder has been played, then playback stops at the start position of the last file.
- When [Playback range] is set to [Folder], [End] blinks in the display for 2 seconds after the last file in the folder has been played, then playback stops at the start position of the first file in the folder.

Setting a skip space [Skip Space]

The [Skip Space] function lets you skip a preset amount forward (forward skip) or backward (reverse skip) in a file during playback. It is handy for quickly moving the playback position, or for repeated playback of a short segment.

When [Normal Mode] was selected

1 Press the +/- button to select [Forward Skip] or [Reverse Skip].

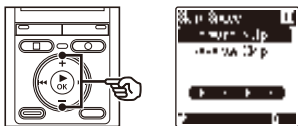

[Forward Skip]:

Starts playback after moving the playback position forward by the set amount.

[Reverse Skip]:

Starts playback after moving the playback position backward by the set amount.

2 Press the +/- button to select a setting.

When [Forward Skip] was selected:

[File Skip], [10 sec. Skip], [30 sec. Skip],
[1 min. Skip], [5 min. Skip], [10 min. Skip]

When [Reverse Skip] was selected:

[File Skip], [1 sec. Skip] to [3 sec. Skip],
[5 sec. Skip], [10 sec. Skip], [30 sec. Skip],
[1 min. Skip], [5 min. Skip]

Playback menu [Play Menu]

When [Simple Mode] was selected

- 1 Press the +/- button to select [File Skip], [◀◀5sec 10sec▶▶] or [◀◀5min 10min▶▶].

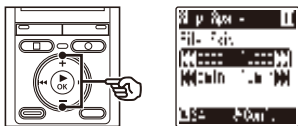

[File Skip]:

Skips in units of files.

[◀◀5sec 10sec▶▶]:

Pressing the ◀◀ button rewinds 5 seconds; pressing the ▶▶ button fast-forwards 10 seconds and then the playback starts.

[◀◀5min 10min▶▶]:

Pressing the ◀◀ button rewinds 5 minutes; pressing the ▶▶ button fast-forwards 10 minutes and then the playback starts.

NOTE

- Forward/reverse skip operations over a skip space that contains an index mark/temp mark or the starting position of a file will stop at that mark or at the start position.

Forward/reverse skip playback

- 1 Press the ▶ OK button to start playback.
- 2 Press the ▶▶ or ◀◀ button during playback.
 - Playback starts after skipping forward or backward by the set amount.

LCD/Sound menu [LCD/Sound Menu]

Adjusting the contrast [Contrast]

You can adjust the contrast of the display to 12 different levels.

- The setting can be adjusted to between [01] to [12].

Setting the LED indicator light [LED]

You can set the LED indicator light to not become lit.

- [On]:
LED indicator light is switched on.
- [Off]:
LED indicator light stays off.

Turning beeping sound ON/OFF [Beep]

The voice recorder makes beeping sounds when buttons are pressed, or to warn in case of operation errors. You can select whether the voice recorder makes these beeping sounds.

- [On]:
Enables beeping sounds.
- [Off]:
Disables beeping sounds.

Changing the display language [Language]

You can select the language used in the voice recorder's displays.

- [Čeština], [Dansk], [Deutsch], [English], [Español], [Français], [Italiano], [Nederlands], [Polski], [Русский], [Svenska], [簡體中文], [繁體中文].

TIP

- The language selections vary depending on where the voice recorder was purchased.

Device menu [Device Menu]

Selecting the recording media [Memory Select]

If a microSD card is inserted into the voice recorder, you can select whether to record on the internal memory or on the microSD card (see P.11).

! VN-733PC and VN-732PC models only

[Internal memory]:

Records on the internal memory on the voice recorder.

[microSD card]:

Records on the microSD card.

Setting the date/time [Time & Date]

Set the date and time beforehand to enable easier management of recorded files.

- 1 Press the ►► or ◀◀ button to select the desired setting item.

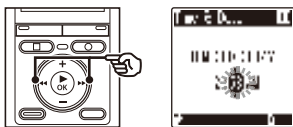

- 2 Press the +/- button to change the number.

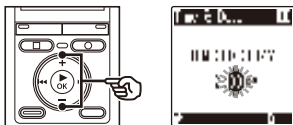

- To change the setting of another item, press the ►► or ◀◀ button to move the blinking cursor, then press the + or - button to change the number.

- 3 Press the ► OK button to finalize the setting.

TIP

- When setting the hour or minute, each time you press the **FOLDER/INDEX** button the display changes between the AM/PM and 24-hour clock formats.

Example: 10:38 PM

10:38 PM ←→ 22:38
(default format)

- When setting the year, month or date, each time you press the **FOLDER/INDEX** button the display order used for the date changes.

Example: March 24, 2014

3M 24D 2014Y
(default format)

↓
24D 3M 2014Y

↓
2014Y 3M 24D

NOTE

- Even if the voice recorder is not used for a long period of time, when the battery is used up, the date and time must be re-entered.
- The time automatically flashes when the battery is replaced.

Selecting the mode [Mode Select]

With this recorder, you can choose between normal mode and simple mode, which lists frequently used functions. In simple mode, the displayed text becomes larger for easier viewing.

[Normal Mode]:

This is the standard mode in which all functions are available.

[Simple Mode]:

This mode lists frequently used functions. Displayed text becomes larger for easier viewing.

Setting the USB connection [USB Settings]

The **[PC]** setting lets you connect the voice recorder to a PC to transfer files; the **[AC Adapter]** setting lets you supply power from a USB-connection AC adapter (model A514; optional).



VN-733PC model only

[PC]:

Select to connect the voice recorder to a PC. The voice recorder will be connected as a storage device.

[AC Adapter]:

Select to supply power from a PC or AC adapter.

[Optional]:

Select to confirm the connection method whenever making a USB connection.

TIP

- If the voice recorder is not recognized by the PC as an external memory device, select **[PC]** for **[USB Settings]**.
- If **[AC Adapter]** is selected for **[USB Settings]**, the voice recorder will not be recognized if connected to a PC.

NOTE

- Remove the USB cable while the voice recorder is stopped.

Restoring the default settings [Reset Settings]

The **[Reset Settings]** function restores all the voice recorder's functions to their initial (factory default) settings. Time setting and file number will remain the same.

- 1 Press the + button to select [Start].**

Rec Menu:

- Rec Level: High
- Rec Mode: MP3 128 kbps^{*1}
WMA 64 kbps^{*4}
- Low Cut Filter: Off
- VCVA: Off
- V-Sync Rec^{*1}: Off
- Rec Scene: Off

Play Menu:

- Noise Cancel^{*2}: Off
- Voice Balancer^{*2}: Off
- Voice Filter^{*3}: Off
- Play Mode:
 - Playback Range: File
 - Repeat: Off
- Skip Space:
 - Forward Skip: File Skip
 - Reverse Skip: File Skip

LCD/Sound Menu:

- Contrast: Level 06
- LED: On
- Beep: On
- Language: English

Device Menu:

- Memory Select^{*1}: Internal memory
- Mode Select: Normal Mode
- USB Settings^{*2}: PC

***1** VN-733PC and VN-732PC models only

***2** VN-733PC model only

***3** VN-732PC model only

***4** VN-731PC model only

Formatting a recording media**[Format]**

Formatting a recording media erases all existing files saved on it. Be sure to transfer all important files to a PC before formatting. For VN-731PC, go to Step 3.

- 1 Press the +/- button to select the recording media to be formatted.**

[Internal memory]:

Formats the internal memory.

[microSD card]:

Formats the microSD card.

* VN-733PC and VN-732PC models only

- 2 Press the ►OK button.**

- 3 Press the + button to select [Start], then press the ►OK button.**

- 4 Press the + button to select [Start] again, then press the ►OK button.**

- **[Formatting!]** appears, and formatting starts.
- **[Format done]** appears when the process has finished.

TIP

- To reset all the voice recorder's settings to their default values, use the **[Reset Settings]** operation (P.47).

NOTE

- Never format the voice recorder from a PC.
- Formatting erases all the existing data, including locked files and read-only files.
- Before formatting, replace the battery to ensure it will not run out before the process has finished. The formatting process can sometimes take over 10 seconds to complete. To prevent the risk of damage to data, never attempt to perform any of the following processes before a formatting process has finished:
 - ① Removing the battery
 - ② Removing the microSD card (if the recording media to be initialized is a **[microSD card]**) (VN-733PC and VN-732PC models only).

VN-733PC and VN-732PC models only:

- If there is a microSD card in the voice recorder, make sure **[Internal memory]** or **[microSD card]** has been correctly selected as the recording media to erase (P.46).
- Even when formatting or erasing (P.32) is performed, only the file management information of the internal memory and/or microSD card is updated and the recorded data is not completely erased.

When disposing of a microSD card, be sure to destroy the card, format the card and record silence until the recording time runs out, or perform a similar operation in order to prevent the leakage of personal information.

Checking recording media information [Memory Info.]

You can display the capacity and remaining memory space of the recording media from a menu screen.

NOTE

- Some recording media memory capacity is used as a management area, so the actual usable capacity will always be slightly less than the displayed capacity.

Checking voice recorder information [System Info.]

You can display voice recorder information from a menu screen.

- The voice recorder's **[Model]**, **[Version]** (system version) and **[Serial No.]** information is displayed.

Use with a PC

Connecting the voice recorder to a PC lets you:

- Play WMA and MP3*-format language-learning content and music files loaded on a PC using Windows Media Player or iTunes.
- As well as a voice recorder and music player, you can use this device as a PC's external memory device to save or read data from the PC.

* VN-733PC and VN-732PC models only

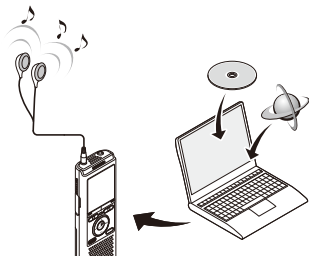

5 PC operating environment

Windows

Operating system

Microsoft Windows XP/Vista/7/8
standard installation

PC

Windows PC with at least one available USB
port

Macintosh

Operating system

Mac OS X 10.5 to 10.9
standard installation

PC

Apple Macintosh series PC with at least one
available USB port

NOTE

- The requirements shown are the operating environments needed for using a USB connection to save files recorded by the voice recorder on a PC.
- Even when the requirements for the operating environment are satisfied, updated versions of OS, multiboot environments, self-modified PCs will not be covered under the operational warranty.
- When uploading or downloading a file to or from the voice recorder, data transfer will continue as long as the voice recorder's LED indicator light is flashing, even if the PC data communication screen disappears. Never disconnect the USB connector before data communication has finished. Always use the procedure on **P.52** to disconnect the USB connector. Data may not be transferred correctly if you disconnect the connector before the drive has stopped.
- Do not format (initialize) the voice recorder's drive from a PC. Formatting done from a PC will not be done correctly. Use the voice recorder's **[Format]** menu for formatting (**P.48**).

PC connection/disconnection

Connecting the voice recorder to a PC

- 1 Start the PC.
- 2 Connect the voice recorder and PC using the Portable USB cable.

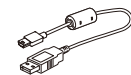
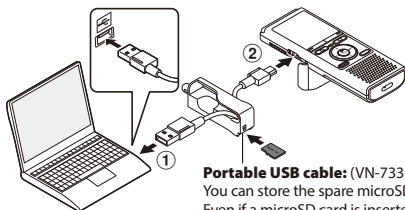

For VN-731PC, use the USB cable.

Portable USB cable: (VN-733PC and VN-732PC models only)
You can store the spare microSD card in the Portable USB cable.
Even if a microSD card is inserted, it cannot be used as USB memory.

- ① Connect the Portable USB cable to the USB port on the PC.
- ② Check that the voice recorder is in stop mode, then connect the Portable USB cable.
 - **[Remote]** appears in the voice recorder's display when the USB connector is connected.

TIP

- Windows: The voice recorder is recognized and displayed in the **[My Computer]** folder with the model name as the drive name. If there is a microSD card in the voice recorder, it can be used as the **[Removable Disk]**.
- Macintosh: The voice recorder is recognized and displayed on the desktop with the model name as the drive name. If there is a microSD card in the voice recorder, **[Untitled]** is displayed.
- For information on the PC's USB port, see the PC's user manual.

NOTE

- The voice recorder must not be in HOLD mode.
- Insert the USB connector securely all the way. Operation will not be normal if the connection is not made properly.
- Connecting the voice recorder through a USB hub may result in unstable operation. Do not use a USB hub if operation is unstable.
- Use only a compatible Olympus USB cable. Operation is not guaranteed if another manufacturer's cable is used. Only use the Olympus USB extension cable with the voice recorder and never use it with another manufacturer's products.

Disconnecting the voice recorder from a PC

Windows

- 1 On the task bar at the bottom-right of the screen, click [] and select [Safely remove USB Mass Storage Device].



- The letter used to identify the drive will vary according to your PC.
- When the window indicating it is safe to remove hardware appears, close the window.

- 2 Check that the voice recorder's LED indicator light is off before disconnecting the voice recorder from the PC.

Macintosh

- 1 Drag-and-drop the removable disk icon for the voice recorder shown on the desktop to the trash can icon.

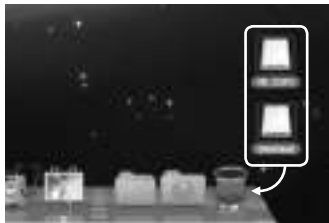

- 2 Check that the voice recorder's LED indicator light is off before disconnecting the voice recorder from the PC.

NOTE

- To prevent the risk of data damage, never disconnect the voice recorder from the USB port while the LED indicator light is flashing.
- In the Mac OS operational environment, WMA format files cannot be played back.

Loading a file to a PC

The voice recorder's five folders are displayed on the PC as [FOLDER_A], [FOLDER_B], [FOLDER_C], [FOLDER_D] and [FOLDER_E]. You can copy voice recorder files to any folder on the PC.

Windows

- 1 **Connect the voice recorder to the PC** (☞ P.51).
- 2 **Open Windows Explorer.**
 - When you open [My Computer], the voice recorder is recognized and displayed with the model name as the drive name.
- 3 **Click on the folder labeled with your voice recorder's model name.**
- 4 **Copy the desired data to the PC.**
- 5 **Disconnect the voice recorder from the PC** (☞ P.52).

Macintosh

- 1 **Connect the voice recorder to the PC** (☞ P.51).
 - When the voice recorder is connected to the Macintosh operating system, it is recognized and displayed on the desktop with the model name as the drive name.
- 2 **Double-click the removable disk icon labeled with your voice recorder's model name.**
- 3 **Copy the desired data to the PC.**
- 4 **Disconnect the voice recorder from the PC** (☞ P.52).

■ Voice recorder drive name and folder names on the PC

Internal memory

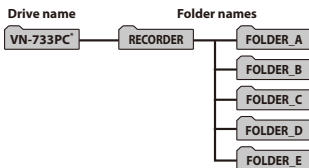

microSD card

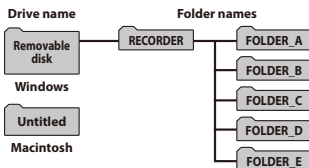

* Recognized/displayed by voice recorder drive name.

NOTE

- To prevent the risk of data damage, never disconnect the voice recorder from the USB port while the LED indicator light is flashing.
- WMA-format files cannot be played in the standard Macintosh operating system.

Other information

Alarm message list

Message	Meaning	Action required
Battery low	The remaining battery power is low.	Replace the battery (P.8).
File locked	An attempt was made to erase a locked file.	You must unlock the file before you can erase it (P.37).
No more can be set	The maximum number of index marks (99) have been written in the file.	Erase unneeded index marks (P.31).
	The maximum number of temp marks (99) have been written in the file.	Erase unneeded temp marks (P.31).
Folder full	The maximum number of files (200) have been saved in the folder.	Erase unneeded files (P.32).
Memory error	An internal memory error occurred.	Contact the Olympus Customer Support Center (P. back cover).
Card error	VN-733PC and VN-732PC models only	
	The microSD card was not recognized correctly.	Remove and reinsert the microSD card (P.11, P.12).
Memory full	There is no remaining memory.	Erase unneeded files (P.32).
No file	There are no files in the folder.	Select another folder (P.15).
Format error	A formatting problem occurred.	Format the memory again (P.48).

Troubleshooting

Problem	Possible cause	Solution
The display is blank.	The battery is not inserted properly.	Check that the positive and negative terminals of the battery are placed correctly (☞ P.8).
	The remaining battery power is low.	Replace the battery (☞ P.8).
	The power is OFF.	Turn the power ON (☞ P.9).
Unable to operate the voice recorder.	The remaining battery power is low.	Replace the battery (☞ P.8).
	The power is OFF.	Turn the power ON (☞ P.9).
	The voice recorder is in HOLD mode.	Release HOLD mode (☞ P.13).
Unable to record.	There is no remaining memory.	Erase unneeded files (☞ P.32).
	The maximum number of recordable files has been reached.	Select another folder (☞ P.15).
Playback is inaudible.	The earphones are connected to the EAR jack.	To output the playback through the built-in speaker, disconnect the earphones.
	The volume is set to [00] .	Adjust the volume (☞ P.24).
Unable to erase a file.	The file is locked.	You must unlock the file before you can erase it (☞ P.37).
	The file is a read-only file.	Unlock the file, or undo the read-only setting on a PC.
Unable to write index marks/temp marks.	The maximum number of marks (99) has been reached.	Erase unneeded marks (☞ P.31).
	The file is locked.	Unlock the file (☞ P.37).
	The file is a read-only file.	Unlock the file, or undo the read-only setting on a PC.
The PC is unable to recognize the voice recorder.	VN-733PC model only	
	[AC Adapter] has been selected for [USB Settings].	Select [PC] for [USB Settings] (☞ P.47).

Accessories (optional)

Accessories for Olympus voice recorders can be purchased directly from the Online Shop on the Olympus website.

Availability of accessories differs depending on the country.

ME51SW stereo microphone

Has a large-diameter built-in microphone for sensitive stereo recording.

ME34 compact zoom microphone (unidirectional)

Comes with an integrated tripod ideal for table placement when recording events from a distance, such as conferences or lectures.

ME33 boundary microphone

A microphone for recording conferences that enables connection of up to three left- and three right-channel units. Cascade connection enables the left/right channel connections to be extended up to about 12 meters, to capture sound from a broad range.

ME52W mono microphone (unidirectional)

Designed to record sound from a distance while minimizing the impact of surrounding noise.

ME15 mono tie clip microphone (omnidirectional)

A small, unobtrusive microphone that comes with a tie-clip.

TP8 telephone pickup microphone

An earphone microphone that can be worn in the ear during phone calls. Clearly captures voices and conversations during phone calls.

A514 USB-connection AC adapter

A USB-connected AC adapter that provides 5-volt DC output. (100-240 VAC, 50/60 Hz)

KA333 connecting cord

A resistive connection cord with stereo mini-plugs (3.5 mm diameter) on both ends. Used to connect the earphone jack output to the microphone input when recording. Comes with plug adapters (PA331/PA231) that adapt to mono mini-plugs (3.5 mm diameter) or mono mini-plugs (2.5 mm diameter).

Copyright and trademark information

- The information in this document is subject to change in future without prior notice. Contact Olympus Customer Support Center for the latest product names, model numbers and other information.
- Voice recorder displays and product illustrations shown in this manual may differ from the actual product. While every precaution has been taken to ensure the accuracy of the information in this manual, errors may occasionally arise. Any questions or concerns regarding doubtful information, or possible errors or omissions should be directed to the Olympus Customer Support Center.
- Olympus Corporation and Olympus Imaging Corp. are the copyright holders of this manual. Copyright law prohibits unauthorized reproduction of this manual, or unauthorized distribution of reproductions thereof.
- Note that Olympus will assume no liability in the event of damages, lost earnings, or any claims from third parties resulting from improper use of the product.

Trademarks and registered trademarks

- IBM and PC/AT are trademarks or registered trademarks of International Business Machines Corporation.
- Microsoft, Windows and Windows Media are registered trademarks of Microsoft Corporation.
- microSD and microSDHC are trademarks of the SD Card Association.
- Macintosh and iTunes are trademarks of Apple Inc.
- The product uses MP3 audio coding technology licensed from Fraunhofer IIS and Thomson.
- The product uses noise-canceling technology licensed from NEC Corporation.

All other brand or product names in this manual are the trademarks or registered trademarks of their respective owners.



Safety precautions

Before using the voice recorder, read this manual to ensure correct and safe operation. After reading this manual, be sure to keep it on hand for ready reference whenever needed.

Important safety precautions

- Important safety precautions in this manual are accompanied by the symbol and labels below. Always follow these precautions to prevent harming yourself or others, or causing damage to property.
- The meaning of each precaution type is given below.



DANGER

A precaution about an imminent danger that is expected to result in death or serious injury if equipment is handed incorrectly.



WARNING

A precaution about a situation that is expected to potentially result in death or serious injury if equipment is handled incorrectly.



CAUTION

A precaution about a situation that is expected to potentially result in injury, or is expected to result only in property damage, if equipment is handled incorrectly.

Voice recorder safety precautions



WARNING

- **Do not use the voice recorder in an atmosphere that might contain flammable or explosive gases.**
It may cause fire or explosion.
- **Do not attempt to disassemble, repair or modify the voice recorder.**
It may cause electric shock or injury.
- **Do not operate the voice recorder while operating a vehicle (such as a bicycle, motorcycle or car).**
It may cause traffic accidents.
- **Do not leave the voice recorder in a location accessible to an infant or child.**

Pay attention when using the voice recorder near an infant or child, taking care not to leave it unattended. Infants and children are unable to understand voice recorder safety precautions, and are at risk of accidents such as:

- Strangulation caused by accidental entanglement of the earphone cord around the neck.
- Operation errors resulting in injury or electric shock.

- **Use microSD/microSDHC memory cards only. Never place other types of cards in the voice recorder.**

If another card type is placed in the voice recorder by accident, do not try to pull it out by force. Contact an Olympus repair center or service center.

Safety precautions

- **If the voice recorder is dropped in water or, if water, metal or combustible foreign matter gets inside:**

- ① Remove the battery immediately.
- ② Contact your place of purchase or an Olympus service center for repair. Continued use may result in fire or electric shock.

- **Do not use the voice recorder or use it only as directed in airplanes, hospitals or other locations where use of electronic devices is restricted.**
- **Stop using the voice recorder if you notice unusual odor, noise, or smoke coming from it.**

It may cause fire or burns. Remove the battery immediately, taking care not to burn yourself. Contact your place of purchase or an Olympus repair center or service center. (Do not touch the battery with bare hands when removing it. Remove the battery outdoors, and away from flammable objects.)

- **When carrying the voice recorder by its strap, take care to prevent it becoming caught on other items.**

CAUTION

- **Do not raise the volume before performing an operation.**
Hearing damage or loss may result.

Batteries

DANGER

- **Do not place the battery near ignition sources.**
- **Do not incinerate, heat or disassemble the battery. Do not short-circuit the battery's positive and negative electrodes.**
It may cause fire, ruptures, combustion or overheating.
- **Do not solder connections directly onto the battery. Do not deform, modify or disassemble the battery.**
- **Do not connect the battery's positive and negative terminals.**
It may cause overheating, electric shock or fire.
- **When carrying or storing the battery, always place it in the case and protect its terminals. Do not carry or store the battery together with precious metal items such as key rings.**
It may cause overheating, electric shock or fire.
- **Do not connect the battery directly to a power outlet or car cigarette lighter.**
- **Do not use or leave the battery in a hot location such as in direct sunlight, inside a vehicle on a hot day, or near a room heater.**
It may cause fire, burns or injuries from leaking, overheating or ruptures.

Safety precautions



WARNING

- **Do not touch or hold the battery with wet hands.**

It may cause electric shock or product failure.

- **Do not use a battery with a scratched or damaged case.**

It may cause ruptures or overheating.

- **Do not insert the battery with its positive/negative terminals in the opposite direction.**

It may cause leaking, overheating, combustion or ruptures.

- Do not use a battery with a torn casing seal (insulating covering).
- Always remove the battery when the voice recorder will not be used for an long period.
- When disposing used batteries, insulate their contacts with tape and discard them as general waste in the manner prescribed by the local authority.
- Remove the battery from the voice recorder as soon as the battery becomes unusable. It may cause leakage.

- **Battery fluid in the eyes may cause blindness. If battery fluid gets in eyes, do not rub the eyes. Instead, rinse them thoroughly with tap water or other clean water right away. Go to doctor immediately.**

- **Do not attempt to recharge alkaline, lithium or any other non-rechargeable batteries.**

- **Keep the battery out of the reach of infants and children.**

The battery could be swallowed by an infant or child. If swallowed, go to doctor immediately.

- **If you notice abnormal sound, heat, burning odor or smoke from the voice recorder during use:**

- ① Remove the battery immediately, taking care not to injure yourself.
- ② Have the voice recorder repaired by your place of purchase or an Olympus service center. Continued use may result in fire or burns.

- **Do not submerge the battery in freshwater or saltwater, or allow its terminals to become wet.**

- **Discontinue use of the battery if it develops a problem such as leaking, discoloration or deformation.**

- **Battery fluid on clothing or skin may damage the skin, so rinse the battery fluid off right away with tap water or other clean water.**



CAUTION

- **Do not throw the battery around, or subject it to strong shocks.**
- **Recycling batteries helps saving resources. When disposing a used battery, always cover its terminals and observe local laws and regulations.**

Operating precautions

- Do not leave the voice recorder in hot or humid locations such as in direct sunlight inside a vehicle, or on a beach during summer.
- Do not store the voice recorder in humid or dusty locations.
- If the voice recorder becomes wet or damp, wipe off the moisture right away with a dry cloth. Contact with salt water should be particularly avoided.

Safety precautions

- Do not place the voice recorder on top of or near a TV, refrigerator or other electrical appliance.
- Prevent sand or mud from getting on the voice recorder. It may cause product not to be repairable.
- Do not subject the voice recorder to intense vibrations or shocks.
- Do not use the voice recorder in humid locations.
- Placing a magnetic card (such as a bank cash card) near the speaker or earphones may cause errors in the data stored on the magnetic card.

<Data loss precautions>

- Recorded content in the internal memory and microSD card may be destroyed or lost due to reasons such as operating errors, device failure or repair.
- Also, when content is saved in the memory for long period of time or is used repeatedly, operations such as writing to, reading from, or erasing of contents may not be possible.
- Making a backup of important recorded information and saving it on a PC's hard disk or other recording media is recommended.
- Note that Olympus will assume no liability for damages or lost earnings resulting from recorded data damage or loss, regardless of the nature or cause thereof.

<Recorded file precautions>

- Note that Olympus will assume no liability for recorded files being erased or becoming unplayable due to voice recorder or PC failure.
- Recording of copyrighted material is permitted when the recording is for your personal use only. Any other type of use without the permission of the copyright owner is prohibited by copyright law.

<Voice recorder and microSD cards disposal precautions>

- Even when formatting (P.48) or erasing (P.32) are performed, only the file management information of the internal memory and/or microSD card is updated and the recorded data is not completely erased.

When disposing of the voice recorder or a microSD card, be sure to destroy it, format and record silence until the recording time runs out, or perform a similar operation in order to prevent the leakage of personal information.

Recorder care

● Exterior

Wipe gently with a soft cloth. If the recorder is very dirty, soak the cloth in mild soapy water and wring well. Wipe the recorder with the damp cloth and then wipe it with a dry cloth.

● Monitor

Wipe gently with a soft cloth.

NOTE

- Do not use benzene, alcohol or other strong solvents, or chemical cleaning cloths.

Specifications

General items

■ Recording formats

MP3 (MPEG-1 Audio Layer 3) format
WMA (Windows Media Audio) format

■ Sampling frequency

MP3 format*1

192 kbps	44.1 kHz
128 kbps	44.1 kHz

WMA format

64 kbps*2	44.1 kHz
32 kbps	44.1 kHz
5 kbps	8 kHz

■ Maximum working output

320 mW (8 Ω speaker)

■ Maximum headphone output

≤ 150 mV (conforms to EN 50332-2)

■ Recording media*

Internal NAND flash memory

VN-733PC model: 4 GB

VN-732PC model: 4 GB

VN-731PC model: 2 GB

microSD card*1

(Supports card capacities ranging from 2 to 32 GB.)

* Some recording media memory capacity is used as a management area, so the actual usable capacity will always be slightly less than the displayed capacity.

■ Speaker

Built-in 28 mm diameter round dynamic speaker

■ MIC jack

3.5 mm diameter; Impedance: 2 kΩ

■ EAR jack

3.5 mm diameter; Impedance: 8 Ω minimum

■ Power source

Battery:

AAA dry cell battery (model LR03) x2

External power supply:

USB-connection AC adapter (model A514; 5 VDC)

■ External dimensions

108 × 39 × 16.8 mm (Not including largest projection)

■ Weight

71 g (including battery)

■ Operating temperature

0 to 42°C (32 to 107.6°F)

*1 VN-733PC and VN-732PC models only

*2 VN-731PC model only

Frequency response

■ When recording from MIC jack

MP3 format*1

192 kbps	70 Hz to 19 kHz
128 kbps	70 Hz to 17 kHz

WMA format

64 kbps*2	70 Hz to 15 kHz
32 kbps	70 Hz to 13 kHz
5 kbps	70 Hz to 3 kHz

*1 VN-733PC and VN-732PC models only

*2 VN-731PC model only

■ When recording with built-in microphone

70 Hz to 16 kHz (frequency response upper limit is set by recording mode during MP3/WMA-format recording)

■ During playback

20 Hz to 20 kHz (However, the upper and lower limits of the frequency characteristic depend on each recording format)

Battery life

The figures below are guideline values.

■ Alkaline dry cell battery

Recording mode		When recording with built-in microphone	During speaker playback	During earphone playback
MP3 format*1	192kbps	68 hours (approx.)	16 hours (approx.)	70 hours (approx.)
	128 kbps	70 hours (approx.)	16 hours (approx.)	70 hours (approx.)
WMA format	64 kbps*2	74 hours (approx.)	17 hours (approx.)	75 hours (approx.)
	5kpbs	100 hours (approx.)	17 hours (approx.)	75 hours (approx.)

*1 VN-733PC and VN-732PC models only

*2 VN-731PC model only

NOTE

- The battery life figures shown here were determined using an Olympus test method. Actual battery life figures will vary greatly according to the battery used and usage conditions (Changing the playback speed, or using the **[Voice Balancer]** and **[Voice Filter]** functions may affect the battery life).

VN-733PC and VN-732PC models only

- Battery life will be shorter when using a microSD card.

Specifications

Recording time

The figures below are guideline values.

■ MP3 format *1

Recording media		Recording mode	
		192 kbps	128 kbps
Internal memory	VN-733PC/ VN-732PC (4 GB)	43 hours, 30 minutes (approx.)	65 hours (approx.)
microSD card *1	32 GB	353 hours (approx.)	530 hours (approx.)
	16 GB	176 hours (approx.)	264 hours (approx.)
	8 GB	87 hours (approx.)	131 hours (approx.)

■ WMA format

Recording media		Recording mode			
		64 kbps	32 kbps	5 kbps	DNS*2
Internal memory	VN-733PC/ VN-732PC (4 GB)	—	256 hours (approx.)	1600 hours (approx.)	64 hours (approx.)
	VN-731PC (2 GB)	63 hours (approx.)	126 hours (approx.)	790 hours (approx.)	—
microSD card *1	32 GB	—	2070 hours (approx.)	12960 hours (approx.)	515 hours (approx.)
	16 GB	—	1030 hours (approx.)	6460 hours (approx.)	258 hours (approx.)
	8 GB	—	510 hours (approx.)	3210 hours (approx.)	128 hours (approx.)

*1 VN-733PC and VN-732PC models only *2 Rec Scene

NOTE

- Actual available recording times may be shorter than the figures shown here when making short recordings repeatedly (Equipment displays of available/elapsed recording times should be considered guideline values).

VN-733PC and VN-732PC models only

- Available recording time will also vary due to differences in the available memory capacity of different microSD cards.

Specifications

Maximum recording time per file

- The maximum file size is limited to about 4 GB in the WMA and MP3 formats.
- Regardless of the amount of remaining memory, the maximum recording time per file is restricted to the following values:

■ MP3 format *1

Recording mode	Recording time
192 kbps	49 hours, 40 minutes (approx.)
128 kbps	74 hours, 30 minutes (approx.)

*1 VN-733PC and VN-732PC models only

■ WMA format

Recording mode	Recording time
64 kbps*2	26 hours, 40 minutes (approx.)
32 kbps	26 hours, 40 minutes (approx.)
5 kbps	148 hours, 40 minutes (approx.)

*2 VN-731PC model only

Note that voice recorder specifications and appearance are subject to change without prior notice for performance improvements or other upgrading.

For customers in Europe:



The "CE" mark indicates that this product complies with the European requirements for safety, health, environment and customer protection.



This symbol [crossed-out wheeled bin WEEE Annex IV] indicates separate collection of waste electrical and electronic equipment in the EU countries. Please do not throw the equipment into the domestic refuse. Please use the return and collection systems available in your country for the disposal of this product.



Applicable Product: VN-733PC/VN-732PC/VN-731PC



This symbol [crossed-out wheeled bin Directive 2006/66/EC Annex II] indicates separate collection of waste batteries in the EU countries. Please do not throw the batteries into the domestic refuse. Please use the return and collection systems available in your country for the disposal of the waste batteries.

OLYMPUS®

OLYMPUS IMAGING CORP.

2951 Ishikawa-machi, Hachioji-shi, Tokyo 192-8507, Japan.

OLYMPUS EUROPA SE & CO. KG

Premises:

Consumer Product Division
Wendenstrasse 14 - 18, 20097 Hamburg, Germany.

Goods delivery:

Tel. :+49 40 -23 77 3-0 / Fax +49 40 - 23 07 61
Modul H, Willi-Bleicher Str. 36, 52353 Düren, Germany.

Letters:

Postfach 10 49 08, 20034 Hamburg, Germany.

European Technical Customer Support:

Please visit our homepage <http://www.olympus-europa.com>

or call our TOLL FREE NUMBER*: **00800 - 67 10 83 00**

for Austria, Belgium, Czech Republic, Denmark, Finland, France, Germany, Luxemburg, Netherlands, Norway, Poland, Portugal, Russia, Spain, Sweden, Switzerland, United Kingdom.

* Please note some (mobile) phone services / provider do not permit access or request an additional prefix to +800 numbers.

For all not listed European Countries and in case that you can't get connected to the above mentioned number please make use of the following

CHARGED NUMBER: **+ 49 40 - 237 73 899.**

OLYMPUS IMAGING AUSTRALIA PTY LTD.

Ground Floor, 82 Waterloo Road, Macquarie Park NSW 2113, Australia

PO Box 1991 Macquarie Centre NSW 2113

Tel: +61 2 9886 3992

<http://www.olympus.com.au>

Customer Service Centres:

Australia

Olympus Imaging Australia Pty Ltd.

Tel: **1300 659 678**

Fax: **+61 2 9889 7988**

<http://www.olympus.com.au>

New Zealand

Dictation Distributors Ltd.

Tel: **0800 659 678**

Fax: **+64 9 303 3189**

<http://www.dictation.co.nz>