

# KODAK PIXPRO AZ401

DIGITAL CAMERA

## User Manual



# BEFORE YOU START

## Declaration of Conformity

Responsible Party: JK Imaging Ltd.

Address: JK Imaging Ltd., 17239 So. Main Street, Gardena, CA 90248 USA

JK Imaging Europe, 71 Clarendon Road, Watford, WD17 1DS, UK

Company Website: kodakpixpro.com

## For Customers in the U.S.A.

### Tested to Comply with FCC Standards FOR HOME OR OFFICE USE

This device complies with part 15 of the FCC Rules. Operation is subject to the following two conditions: (1) This device may not cause harmful interference and (2) this device must accept any interference received, including interference that may cause undesired camera operation.

## For Customers in Europe

 "CE" mark indicates that this product complies with the European requirements for safety, health, environment and customer protection. "CE" marked cameras are intended for sales in Europe.

 This symbol [crossed-out wheel bin WEEE Annex IV] indicates separate collection of electrical waste and electronic equipment in the European countries. Please do not throw the equipment into domestic refuse. Please use the return and collection systems available in your country for proper, safe disposal of this product.

 Batteries: Please dispose of used batteries at designated collection centers.

 Packaging: Please follow local regulations for the recycling of packaging.

## About this Manual

Thank you for purchasing this KODAK PIXPRO Digital Camera. Please read this manual carefully and keep it in a safe place for future reference.

- JK Imaging reserves all rights of this document. No part of this published manual may be reproduced, transmitted, transcribed, stored in a retrieval system or translated into any language or computer language, in any form, by any means, without the prior written permission of JK Imaging.
- All trademarks mentioned in this manual are used for identification purposes only and are properties of their respective owners.
- This manual provides you with instructions on how to use your new KODAK PIXPRO Digital Camera. Every effort has been made to ensure that the contents of this manual are accurate; however JK Imaging reserves the right to make changes without notice.
- Throughout this manual, the following symbols are used to help you locate information quickly and easily:



Indicates useful information.

- The following symbols may be used throughout this manual to facilitate your understanding of how to operate the camera:

[Item properties] : The optional properties in the camera interface are indicated by the [ ] symbol.

# SAFETY NOTES

## Safety Notes for this Camera

- Do not drop the camera or allow it to hit solid objects.
- Do not attempt to disassemble or repair the camera.
- Do not use or store the camera in dusty places or on a beach to help prevent dust or sand from entering the camera, causing possible damage.
- Do not use or store the camera in a hot environment or in direct sunlight.
- Do not use or store the camera near powerful magnetic fields, such as a magnet or transformer.
- Avoid touching the lens of the camera.
- Do not expose the camera to direct sunlight for a long period of time.
- To prevent the camera from being damaged by moisture, do not use or store the camera in very humid environments, such as in rain or near bodies of water.
- If water accidentally comes in contact with the camera, turn the camera off immediately, remove the battery and the memory card and dry it completely within 24 hours.
- When you take the camera from a cold environment to a warmer environment, condensation may occur. Please wait for a reasonable period of time before you turn the camera on.
- Before you remove the battery and memory card, the camera should be turned off.
- When you clean the body of the camera, do not use abrasive, alcohol-based or organic cleansers or solvents.
- Use a professional lens cleaning cloth and appropriate cleaner to wipe and clean the lens.
- Download your photos and remove the memory card when you are going to store the camera for long periods of time.
- If this camera is not in use for a long period of time, please keep it in a dry and clean storage location.
- Our company will not pay compensation for any failure of playback including: pictures or videos damaged or unrecoverable by improper operation.

## Safety Notes for Batteries

- If battery fluid leaks inside the camera, contact our customer service department immediately. If battery fluid leaks onto your skin, rinse your skin immediately with clean water and seek immediate medical attention.
- Disposal of used batteries should be carried out in accordance with your local (national or regional) regulations.
- To prevent batteries from being damaged, do not drop batteries or allow them to hit solid objects or to be scratched by foreign objects.
- Do not let batteries come in contact with metal objects (including coins) to avoid short circuiting, discharging, excessive heat or possible leakage.
- Do not attempt to disassemble batteries.
- Do not expose batteries to water. Always keep battery contacts dry.
- Do not heat batteries or throw them into a fire to avoid a possible explosion.
- Do not store batteries in a hot environment or in direct sunlight.
- When the camera is stored for a long period of time, remove the batteries and keep them in a safe, dry place that is not accessible to infants and children.
- In colder environments, the performance of the batteries could be noticeably reduced.
- When you install the batteries, align the battery markings according to the positive and negative markings inside the camera battery compartment. Never force batteries into the battery compartment.

## Safety Notes for Memory Cards

- We highly suggest buying only well-known, name brand memory cards to ensure peak performance and reliability.
- Format the memory card using the camera before you use it or insert a new one.
- Do not drop the memory card or allow it to hit solid objects to avoid damaging it.
- Do not attempt to disassemble or repair the memory card.
- Do not expose the memory card to water. Always keep it dry.
- Do not remove the memory card when the camera is turned on. Otherwise, the memory card and photo/video files could be permanently damaged.
- Do not directly edit the data on the memory card. Copy the data to your computer before you edit files.
- When the camera is stored for long periods of time, be sure to download your photos and remove the memory card. Store the memory card in a dry environment.
- Do not modify the name of the files or folders of the memory card using your computer. Modifying the file names may cause the files to not be recognized on the camera or a possible permanent error may occur.
- A photo taken with the camera will be stored in the folder that is automatically generated on the memory card. Do not store photos that are not taken using this camera in these folders as the pictures cannot be recognized during playback.
- When you insert the memory card, make sure the notch of the card matches the markings on the top of the camera card slot.

## Other Safety Notes

- Do not disconnect the power or turn the product off during the update process. Doing so may cause incorrect data to be written and the product may not power on later.
- Do not hang the neck strap of the camera around the neck of a child.
- When using your camera on an airplane, observe the relevant rules specified by the airline and FAA regulations.
- Due to the limitations of manufacturing technology, the LCD may have a few dead or bright pixels. These pixels do no effect the quality of the photos or video.
- Do not expose the camera's LCD to water. In a humid environment, only wipe it with a soft, dry, cleaning cloth.
- If the LCD is damaged, pay particular attention to the liquid crystal in the screen. If any of the following situations arise, take the recommended immediate action indicated below:
  1. If liquid crystal comes in contact with your skin, please wipe with a dry cloth, wash thoroughly with soap, and rinse with plenty of clean water.
  2. If liquid crystal gets into your eye, flush the eye immediately with plenty of clean water for at least 15 minutes and then seek medical assistance.
  3. If liquid crystal is swallowed, immediately flush your mouth thoroughly with clean water and induce vomiting. Seek medical assistance.

# CONTENTS

BEFORE YOU START .....	1	Resetting Date/Time .....	19
SAFETY NOTES .....	3	MODE OVERVIEW .....	20
CONTENTS .....	7	Display Setting .....	20
GETTING READY.....	11	Overview of the Screen Icons in Photo Shooting Mode.....	21
Accessories Included.....	11	LCD Screen Display .....	21
Installing Lens Cap and Neck Strap .....	12	Overview of the Screen Icons in Movie Mode.....	23
Part Names .....	13	Overview of the Screen Icons in Playback Mode.....	24
Installing Battery and Memory Card .....	15	Using the Mode Dial .....	25
Turn the Camera On / Off .....	17	Auto Mode .....	26
How to Take Pictures.....	17	Program AE.....	27
Set your Language, Date/Time after the First Power-On.....	18	Shutter Priority .....	27
Resetting your Language.....	18	Aperture Priority .....	28
Set your Language, Date/Time .....	18	Manual Mode .....	28
		Face Beautifier.....	29
		Panorama Mode .....	30



Scene Mode.....	31
Auto Scene (ASCN).....	33
Movie Mode .....	34
Custom Settings .....	35

## BASIC OPERATION..... 37

Using the Zoom Function.....	37
Focus Setting.....	38
Macro Mode.....	39
Self-Timer Setting.....	40
Flash Mode .....	41
White Balance Setting.....	42
Continuous Shot .....	43
EV Setting .....	44
Exposure Compensation .....	44
ISO.....	45
Shutter Adjustment.....	45
Aperture Adjustment .....	46

Using Quick Recording .....	46
“i” Button Function Menu.....	47

## PLAYBACK ..... 48

Viewing Photos and Videos .....	48
Thumbnail View.....	49
Using Zoom Playback (for still pictures only).....	50
Deleting Photos and Videos.....	51
Slideshow .....	52

## USING THE MENUS..... 53

Photo Setup Menu.....	53
Expo Metering (Exposure Metering).....	53
Image Size.....	54
OIS (Optical Image Stabilization) .....	54
Continuous AF.....	55

HDR (High Dynamic Range).....55	Custom Settings .....65
Face Beautifier .....56	Playback Menu .....66
Scene.....56	Playback .....67
Photo Shooting Setting Menu .....58	HDR (High Dynamic Range).....67
Quality .....58	Touch-Up .....68
AF-Assist Beam.....59	Rotate .....69
Digital Zoom .....59	Resize .....70
Date Imprint .....60	“i” Button Playback Function .....71
Quick Review.....60	Playback Setting Menu .....72
Custom Settings .....61	Protect .....73
Face Detection .....61	Delete .....74
Movie Menu .....62	DPOF (Digital Print Order Format) .....75
Expo Metering (Exposure Metering) .....62	Trim.....75
Video Quality.....63	Setup Menu .....76
OIS (Optical Image Stabilization) .....63	Sound Settings.....76
Movie Setting Menu .....64	Power Saver.....77
Digital Zoom .....65	Power Saver.....77

Language.....	77	Supported HDMI Connections .....	86
World Time .....	77	Connecting HDMI-Ready TV.....	86
Date/Time.....	78	Connecting to a PICTBRIDGE™	
LCD Brightness.....	78	Compatible Printer .....	87
Battery Type .....	78	Setting the USB Mode .....	87
File Settings.....	79	Connecting to your Printer.....	88
Format .....	79	Using the PICTBRIDGE™ Menu.....	89
Copy to Card.....	80	Print (with Date) .....	89
File Numbering.....	80	Print (without Date).....	90
Reset.....	81	Print Index .....	91
Firmware (FW) Version .....	81	Print DPOF Images .....	92
		Exit.....	92
<b>CONNECTIONS.....</b>	<b>82</b>		
Connecting to a Computer.....	82	<b>APPENDICES .....</b>	<b>93</b>
Setting the USB Mode .....	82	Specifications.....	93
Transferring Files to Your		Prompts and Warning Messages ....	97
Computer .....	83	Troubleshooting .....	101
Video System .....	84		
Set Eye-Fi Card Connection Mode .	85		

# GETTING READY

## Accessories Included

Your camera box should contain the camera model you purchased along with the following accessories. If anything is missing or appears to be damaged, please contact your retailer or our customer service center.

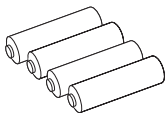

AA Alkaline Battery ×4



Neck Strap

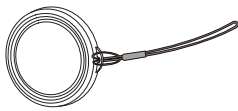

Lens Cap with Cord



Quick Start Guide



Warranty Card



Service Card

## Installing Lens Cap and Neck Strap

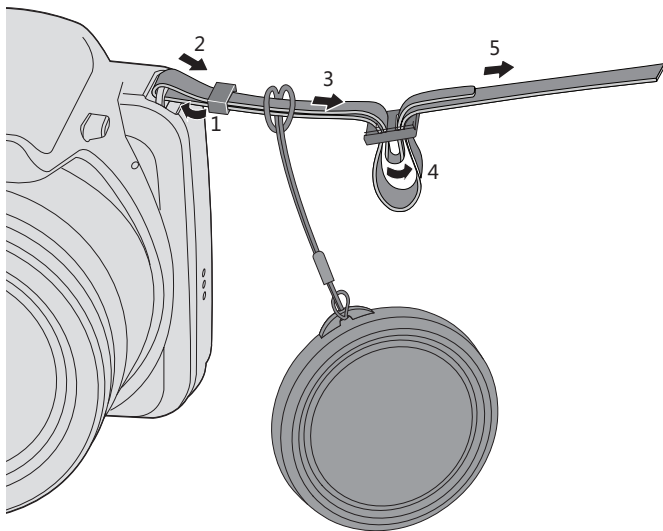

## Part Names

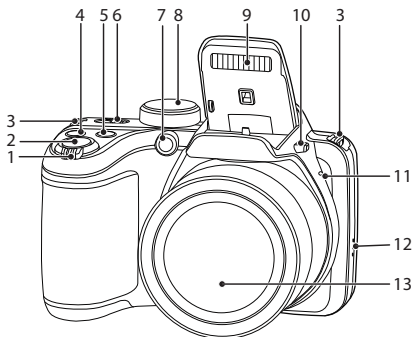

1. Zoom Lever
2. Shutter Button
3. Strap Eyelet
4. Exposure Compensation Button
5. Continuous Shot Button
6. Power Switch
7. AF Assist Beam/Self-Timer Lamp
8. Mode Dial
9. Flash Lamp
10. Flash Button
11. Microphone
12. Speaker
13. Lens

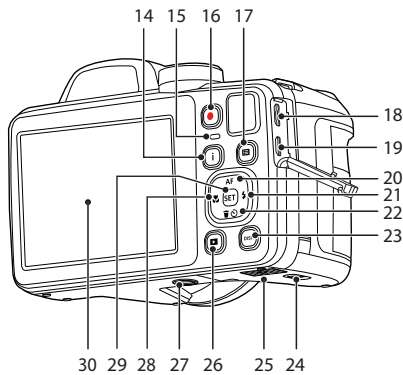

14. "i" Button
15. Indicator Lamp
16. Fast Video Recording Button
17. Menu Button
18. Micro USB Port
19. Micro HDMI Port
20. AF Button/Up Button
21. Flash Button/Right Button
22. Delete Button/Self-Timer Button/  
Down Button
23. Display Button
24. Battery Cover Switch
25. Battery Cover
26. Playback Button
27. Tripod Socket
28. Macro Button/Left Button
29. SET Button
30. LCD

## Installing Battery and Memory Card

1. Open the battery cover door according to diagram (①,②,③) below:
2. Insert the batteries into the battery slot in the correct direction as shown in the following diagram:

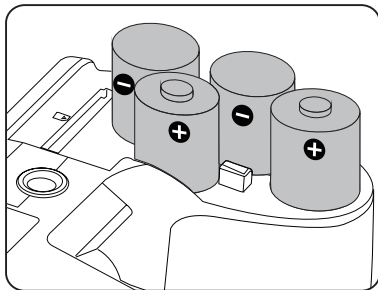
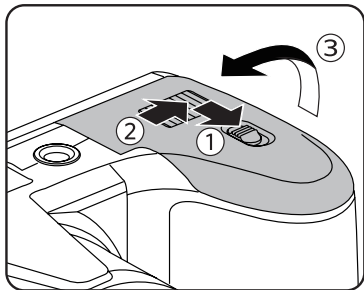

- ① Please use brand name batteries (such as Energizer® or Duracell®) for optimal performance. Do not mix new and old batteries or use different brands of batteries. When replacing batteries, please replace all 4 batteries at the same time.
- ② The performance and life expectancy of alkaline batteries will vary depending on the brand.



3. Insert the memory card into the memory card slot as shown in the diagram below:

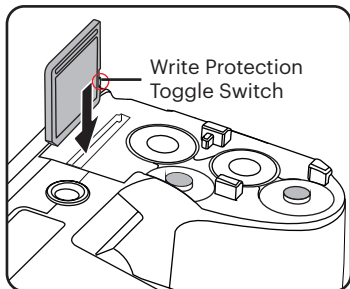

4. Close the battery cover door according to instructions ① and ② below:

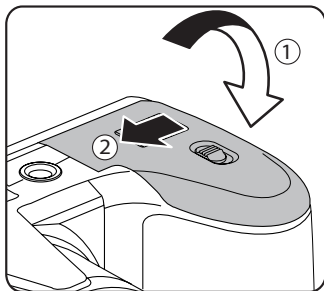

① The memory card (SD/SDHC) is optional and not included in all camera packaging. It needs to be purchased separately. Please use an original memory card which is Class 4 or higher and has a capacity of 4GB to 32GB.

② To remove your memory card, open the battery cover door, gently press the memory card to eject it and remove carefully.

## Turn the Camera On / Off

Slide the Power Switch to turn the camera on/off.

Power Switch

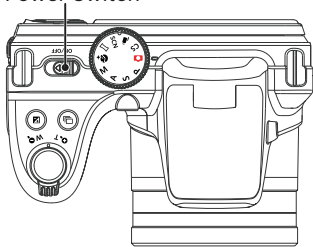

When the power is off, press and hold the Playback  button to power on and enter Playback Mode.

## How to Take Pictures

1. Hold the camera with both hands, being careful not to block the flash and lens with fingers.
2. Point the lens toward the object you want to take a picture of, and then frame it with the LCD.
3. Use the Zoom button to select Tele or the Wide position to zoom in or out on your subject.
4. Press the Shutter button halfway down to focus on the subject. When the focus frame turns green, press the Shutter button down completely to take the picture.

## Set your Language, Date/Time

### Set your Language, Date/Time after the First Power-On

1. When you turn the camera on for the first time, the language selection screen will appear.
  2. Press the arrow buttons to select your desired language.
  3. After you press the **SET** button to confirm your language selection, the Date/Time settings screen will appear.
  4. Press the left/right arrow buttons to select the Date/Time to be adjusted: Time is displayed in YYYY.MM.DD/HH:MM.
  5. Press the up/down arrow buttons to adjust the value for the desired Date/Time.
  6. Press the **SET** button to confirm the time settings and the snapshot screen will appear.
1. Press the **SET** button, then press the up/down arrow buttons to select **SET** and press the **SET** button to enter the menu.
  2. Press the up/down arrow buttons to select **☾**, and press the **SET** button or right arrow button to enter the menu.
  3. Press the up/down arrow buttons to select [Language] and press the **SET** button or right arrow button to enter the menu.
  4. Press the arrow buttons to select your desired language and press the **SET** button to confirm.
  5. Press the **SET** button and the Snapshot screen will appear.

### Resetting your Language







After you set your desired language for the first time, follow the instructions below to reset your language:







## Resetting Date/Time

After you set your Date/Time for the first time, follow the instructions below to reset date and time.

1. Press the  button, then press the up/down arrow buttons to select  and press the  button to enter the menu.
2. Press the up/down arrow buttons to select , and press the  button or right arrow button to enter the menu.
3. Press the up/down arrow buttons to select [Date & Time] and press the  button or right arrow button to enter the menu.
4. Press the left/right arrow buttons to select the Date/Time to be adjusted: Time is displayed in YYYY.MM.DD/HH:MM.

5. Press the up/down arrow buttons to press the value for your selected entry. After you finish entering your settings, press the  button to confirm.
6. Press the  button and the following snapshot screen will appear:

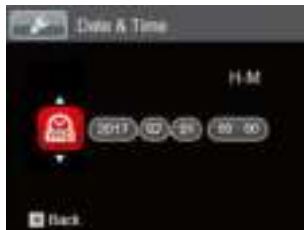
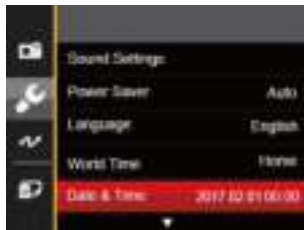

# MODE OVERVIEW

## Display Setting

Press the **DISP.** button to display the settings: Classic, Full, Off.

**Classic:** Displays the camera parameters on screen

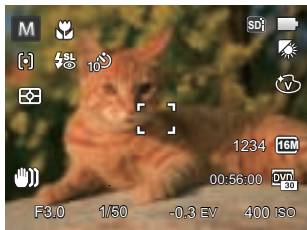

**Off:** Does not display any additional icons on screen



**Full:** Camera parameters with Grid and Histogram

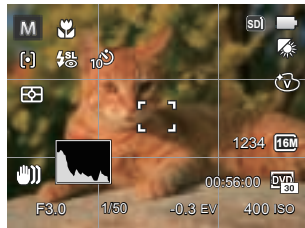

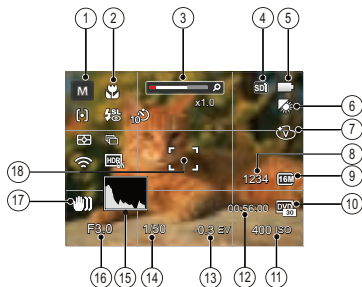

## LCD Screen Display

### Overview of the Screen Icons in Photo Shooting Mode





#### 1 Shooting Mode Icons

 Auto Mode	 Face Beautifier
<b>P</b> Program AE	 Panorama Mode
<b>S</b> Shutter Priority	<b>SCN</b> Scene Mode
<b>A</b> Aperture Priority	<b>CS</b> Custom Settings
<b>M</b> Manual Mode	

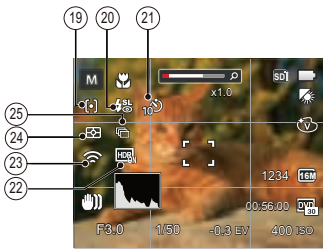





- 2 Macro Mode
- 3 Zoom Display (By turning the Zoom lever)
- 4 Memory Card/Built-In Memory
- 5 Battery Status
- 6 White Balance (Adjustable in **PSAM** Mode)
- 7 Color Effect (Adjustable in **PSAM** Mode)
- 8 Number of Remaining Shots
- 9 Image Size
- 10 Video Quality
- 11 ISO Value (Adjustable in **PSAM +** Mode)
- 12 Remaining Recording Time
- 13 Exposure Compensation (EV value) (Adjustable in **PSA +** Mode)
- 14 Shutter Speed (Adjustable in **SM** Mode)
- 15 Histogram
- 16 Aperture Value (Adjustable in **AM** Mode)
- 17 Image Stabilization
- 18 Focus Frame



## 19 AF Mode

-  Single-AF
-  Multi-AF
-  Object Tracking

## 20 Flash Mode

-  Force Off
-  Flash Auto
-  Force Flash
-  Slow Sync.
-  Slow Sync. + Red-Eye
-  Red-Eye Reduction

## 21 Self-Timer

-  Self-Timer Off
-  Self-Timer 2 sec
-  Self-Timer 10 sec
-  Self-Timer Smile





## 22 HDR (Adjustable in PSAM Mode)

## 23 Eye-Fi On (with signal)

## 24 Expo Metering

-  AiAE
-  Spot
-  Center

## 25 Continuous Shot

-  Single
-  Continuous Shot
-  3 Shots
-  Time-Lapse (30sec/ 1min/ 5min/ 10min)

## Overview of the Screen Icons in Movie Mode

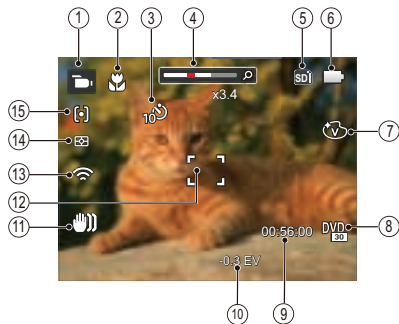

1 Movie Mode Icons

2 Macro Mode

3 Self-Timer



Self-Timer Off



Self-Timer 10 sec

4 Zoom Display (by turning the Zoom lever)

5 Memory Card/Built-In Memory

6 Battery Status

7 Color Effect

8 Video Quality

9 Remaining Recording Time

10 Exposure Compensation (EV Value)

11 Image Stabilization

12 Focus Frame

13 Eye-Fi On (with signal)

14 Expo Metering



AiAE



Spot



Center

15 AF Mode



Use an SD memory card with Class 4 or higher for the video recording.



Optical Zoom and Digital Zoom can be adjusted (160X in total). Digital Zoom can be adjusted to 4X.





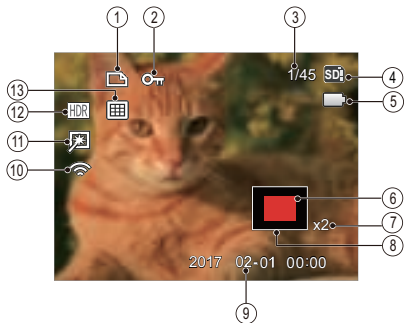

## Overview of the Screen Icons in Playback Mode



- 1 DPOF File
- 2 File Protection
- 3 Memory Space (indicating the current number of photos and total number of photos for card memory size)
- 4 Memory Card/Built-In Memory
- 5 Battery Status
- 6 Zoom Magnification Area
- 7 Image Zoom Ratios
- 8 Image Zone
- 9 Shooting Date
- 10 Eye-Fi On (with signal)
- 11 Touch-Up
- 12 HDR
- 13 Date Folder

## Using the Mode Dial

This camera provides a Convenient Mode dial that allows you to manually switch between different modes with ease. The available modes are listed below:

Mode Name	Icon	Description
Auto Mode		In this mode, the optimal conditions for taking pictures will be automatically set based on the subject and environment. It is the most commonly used mode for taking pictures.
Program AE	<b>P</b>	Under different scenes, the user can switch the ISO and EV value according to personal preference. The camera will automatically set the shutter speed and aperture value.
Shutter Priority	<b>S</b>	Setting allows you to choose a specific shutter speed so the camera will adjust the aperture automatically to ensure correct exposure.
Aperture Priority	<b>A</b>	Allows you to choose a specific aperture and the camera will automatically adjust the shutter speed to match it.
Manual Mode	<b>M</b>	Many of the camera settings can be configured manually in this mode.
Face Beautifier		This mode automatically enhances facial features with skin softening touches and eye brightening capabilities.
Panorama Mode		You can take a panoramic photo in this mode.
Scene Mode	<b>SCN</b>	Choose from 12 different pre-set scene types and effects for your photos.
Movie Mode		Record videos.
Custom Settings	<b>CS</b>	The user can store the most frequently used shooting modes and parameters and switch to this mode for quick adjustment.

## Auto Mode

Auto mode is the most common and easiest mode to take photos. While operating in this mode, the camera automatically optimizes numerous camera settings to adjust optimum settings for your photos and videos for the best possible results.

Follow these steps:

1. Turn the Power Switch to turn the camera on.
2. Turn the Mode dial to .
3. Compose your picture in the LCD and press the shutter button halfway down to focus on the subject.
4. The LCD will show a green focus frame when the subject is in focus.
5. Press the Shutter button all the way down to take your photo.



## Program AE **P**

When **P** (Program AE) Mode is selected, you can adjust the EV value and ISO value.

1. Turn the Mode dial to **P** and press the  button to configure settings.

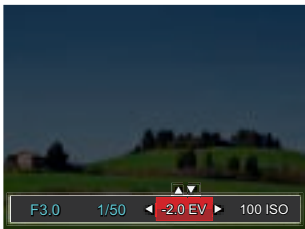



2. Press the left/right arrow buttons to select the setting to adjust.
3. Press the up/down arrow buttons to adjust the setting.
4. Press the  button to engage the settings and enter the shooting screen.

## Shutter Priority **S**

When **S** (Shutter Priority) is selected, you can adjust the shutter speed, ISO value and EV value. The camera automatically sets the aperture value based on the shutter speed value and ISO value to get the most appropriate exposure value.

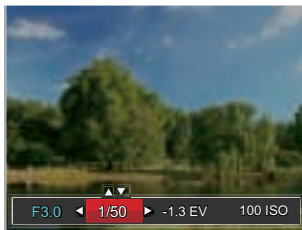
1. Turn the Mode dial to **S** and press the  button to configure settings.



2. Press the left/right arrow buttons to select a setting to adjust.
3. Press the up/down arrow buttons to adjust the setting.
4. Press the  button to confirm the settings and enter the shooting screen.

## Aperture Priority **A**

When selecting **A** (Aperture Priority) Mode, you can adjust the aperture size / EV value and ISO value. Selecting a large aperture opening will emphasize the point of focus and show a blurry background and foreground. A small aperture opening will keep both the background and main object in clear focus.

1. Turn the Mode dial to **A** and press the  button to configure settings.





2. Press the left/right arrow buttons to select a setting to adjust.
3. Press the up/down arrow buttons to adjust the setting.
4. Press the  button to confirm the settings and enter the shooting screen.

## Manual Mode **M**

When selecting Manual (**M**) Mode, you can set the aperture / shutter speed manually and ISO value.

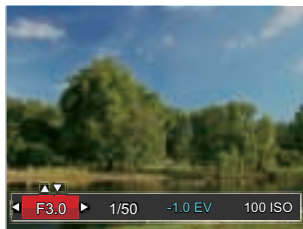



1. Turn the Mode dial to **M** and press the  button to configure settings.





2. Press the left/right arrow buttons to select a setting to adjust.
3. Press the up/down arrow buttons to adjust the setting.
4. Press the  button to confirm the settings and enter the shooting screen.

## Face Beautifier

In Portrait Mode, the camera is set to automatically adjust camera exposure for realistic portrayal of skin tones.

1. Turn the Mode dial to select Face Beautifier Mode (  ).
2. Press the  button and press the up/down arrow buttons to select .
3. Press the left/right arrow buttons to select Face Beautifier Effects and press the  button to confirm and return to photo shooting mode.

Beautifier Mode has 3 effects:

-  Effect 1: Skin Soften
-  Effect 2: Skin Soften + Eye Brightening
-  Effect 3: Skin Soften + Eye Brightening + Eye Enlargement

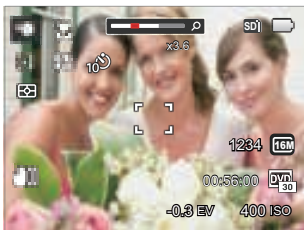

## Panorama Mode

With Panorama Mode, you can take a series of pictures which will be automatically stitched into a ultra-wide panoramic picture by the camera.

Follow the steps below:

1. Turn the Mode dial to Panorama Mode ().
2. Press the arrow buttons to select a desired shooting direction. Should you not select a direction, the default shooting direction is "right." 2 seconds later, the camera will be ready to take pictures. You can also press the **SET** button or press the shutter button halfway down to be ready to take pictures.
3. Compose the first view of the panoramic picture on the LCD and press the Shutter button to capture the image.
4. When you finish shooting the first photo, two target icons will display on the LCD at left and right sides. Move the camera to the right until the round target icon is directly positioned over the square box. The box will turn green when they overlap and the camera will automatically take the next picture. Repeat the same steps for additional shots. Up to 4 frames can be stitched together.
5. If continuous pictures are less than 4 shots, press the **SET** button and the camera will automatically stitch the pictures together. Press the playback button to enter Playback mode to see the end effect.
6. If you take 4 pictures, the camera will automatically stitch the pictures together. Press the playback button to enter Playback mode to see the finished effect.

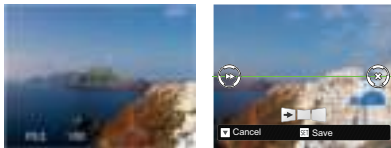

## Scene Mode SCN

In Panorama Mode, the Flash, Self-Timer, Macro Modes and Exposure Compensation are not available. Focus Adjustment is also not available at this time.

In the process of shooting in Panorama Mode, when the LCD shows "Improper alignment. Please try again," it means that in the process of the camera moving, the angle is off the green line and stitching cannot be completed. You will have to try again, keeping the LCD image aligned with the green line.

In order to guarantee the best shooting effect in Panorama Mode, please keep moving horizontally and keep unnecessary shaking to a minimum.

In panorama mode, up to 4 photos can be captured when the image size is set at 2MP.



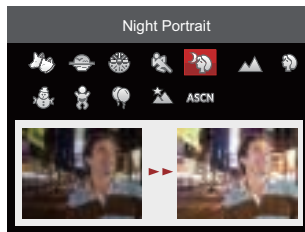

You can select your desired scene from the 12 Scene modes according to the type of environment you are shooting in. The camera then automatically configures the most appropriate settings for the best possible photos.

1. Turn the Mode dial to the Scene Mode, then the LCD will display as below:



2. Press the arrow buttons to select a scene, and press the **SET** button to confirm.
3. If you need to change the scene, please press the **MENU** button, the **SET** button, and finally the arrow buttons to reselect a scene.









Scene	Description
 Pet Mode	Rapidly identifies a pet (dog/cat), capturing the dynamic movement of pets.
 Sunset	For sunsets. Captures subjects in strong sunlight.
 Fireworks	For fireworks at night. The use of a tripod is recommended with this setting.
 Sport	For fast-moving subjects. Captures sharp, action shots with minimal blur. This mode is not recommended for shooting indoors.
 Night Portrait	For taking portraits against night scenery.
 Landscape	For landscapes and outdoor shots. Vivid reproduction of greens and blues.
 Portrait	Most suitable for capturing people, focusing on their face.
 Snow	For snowy conditions. Reproduces natural, clear, white scenes.
 Children	Turns flash off automatically. Avoids disturbing the subjects and is suitable for taking photos of children and pets.
 Party	Suitable for taking indoor party pictures, even under complicated lighting conditions.
 Night Landscape	For night scenes. The use of a tripod is recommended with this setting.
 Auto Scene	Identifies the scene automatically; Person, Backlighting, Landscape, Macro, Night Scene, Night Scene Person and Auto.

## Auto Scene (ASCN)

In “ASCN” Scene Mode, the camera can intelligently detect different environments and automatically select the best scene and photo settings for you.

“ASCN” can intelligently detect the following scenes:

Mode Name	Description
 Landscape Mode	For landscapes, automatically adjusts the exposure and reproduces vivid green and blue colors.
 Portrait Mode	Most suitable for capturing people with focus on their faces.
 Night Portrait	When you take portraits at night, or in low light conditions, automatically adjusts the exposure for people and night scenes.
 Backlit Portrait	When the sun or any other light source is behind you, automatically adjusts the foreground exposure to produce the best pictures possible.
 Night Landscape Mode	For night scenes, automatically increases the ISO value to compensate for low light.
 Macro Mode	The Macro setting is ideal for shooting small objects or close-up photos.
 Auto Mode	The camera automatically adjusts the exposure and focus to ensure the best possible pictures.

## Movie Mode

1. Turn the Mode dial to select Movie Mode (  ).

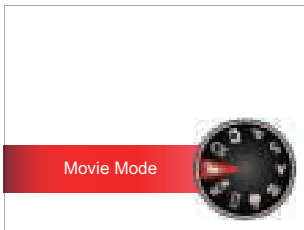

2. Press down the Shutter Button to start recording.
3. Once you are finished, press the Fast Video Recording Button or the Shutter Button to stop recording and return to the shooting screen.

## Custom Settings CS

The user can store frequently used shooting modes and parameters, and switch to this mode for a quick adjustment. Changing these settings will override any previous settings in CS mode.

### Settings under CS mode:

1. Turn the Mode dial to select the **CS** mode and enter the setup screen as shown in the figure below:

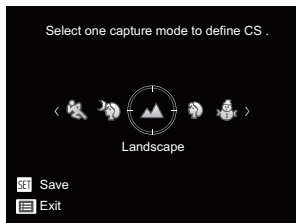

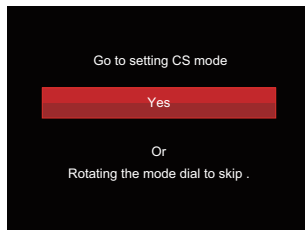

2. As shown in the figure above, press the left/right arrow buttons to select the capture mode that you want to define as **CS** and press the **SET** button to enter the shooting screen.

3. As shown in the figure above, press the **SET** button and choose whether to continue the **CS** mode setting or rotate the Mode dial to skip.



### For setting under other modes (use this method to select a different custom setting):

1. Select any mode to be stored.
2. Set your desired parameters in the current mode.
3. Press the **SET** button, press the up/down arrow buttons to select **SET**, and press the **SET** button to enter the menu.





4. Press the up/down arrow buttons to select , and press the  button or right arrow button to enter the menu.
5. Press the down arrow button select [Custom Settings] and press the  button or the right arrow button to enter the menu.

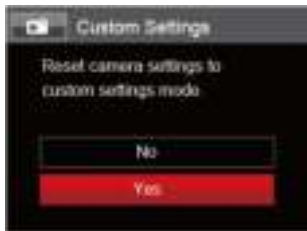

6. Select [Yes] to save or [No] to cancel.



7. Turn the Mode dial to switch to the custom settings (**CS**).
8. The photo settings you stored the last time are used.

-  When **CS** mode is used for the first time, there is no preset parameter stored in the mode.
-  Under the **CS** mode, you need to save or modify the set parameters (except the parameters in ) in restart or all modes. Please enter the [Custom Settings] menu and select [Yes] after setup. Otherwise, the parameter settings will not be saved in the case of switching the camera on/off or in mode switching.
-  If you want to remove the parameter setting in [Custom Settings], please see the reset function instructions on page 80 to change.

# BASIC OPERATION

## Using the Zoom Function

Your camera is equipped with two types of zoom functions: Optical Zoom and Digital Zoom. Toggle the Zoom lever of the camera to zoom in or out on the subject while taking pictures.

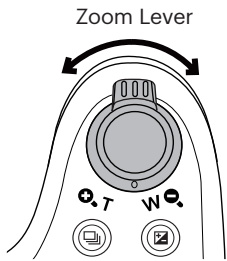

Zoom Indicator

When the Optical Zoom reaches the threshold as Digital Zoom, release and turn the Zoom lever to T to switch between the Optical Zoom and Digital Zoom.

## Focus Setting

In different photo shooting modes, you can select different focus methods.

1. Press the up arrow button ( **AF** ) to display the settings screen.

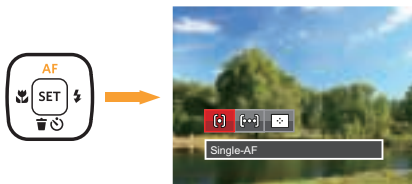

2. Press the left/right arrow buttons to select the following 3 modes:

 **Single-AF**  
The focus frame appears on the center of the LCD to focus on the subject.

 **Multi-AF**  
The camera automatically focuses the subject in a wide area to find the focus point.

 **Object Tracking**  
Smart tracking of the object in motion under the focusing shooting.

3. Press the **SET** button to confirm the settings and exit the menu.

 Once enabled, object tracking will only work when lens is focused on the object.

## Macro Mode

The macro setting is ideal for shooting small objects or close-up photos. This mode allows you to focus on subjects very close to the camera.

1. Press the left arrow button (  ) to enter the Macro menu.



2. Press the left/right arrow buttons to select the following 2 modes:



Macro Off  
Select this option to disable macro.



Macro On  
Select this option to make focusing on the object closer to the lens (At the W side, the shooting distance should be more than 1.6 cm).

3. Press the  button to confirm the settings and exit the menu.





## Self-Timer Setting

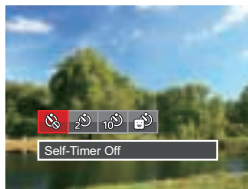

Using this function can take photos at regular intervals. The camera can be set to shoot after 2 seconds, 10 seconds by pressing the shutter or with the Shoot After Smile setting.

1. Press the down arrow button (  ) to enter the Self-Timer menu.





2. Press the left/right arrow buttons to select the following 4 modes:

-  Self-Timer Off  
Disables the Self-Timer.
-  Self-Timer 2 sec  
A single picture is shot 2 seconds after the shutter button is pressed.

-  Self-Timer 10 sec  
A single picture is shot 10 seconds after the shutter button is pressed.
-  Self-Timer Smile  
Press the shutter button and a picture will be taken immediately after a smile is detected.

3. Press the  button to confirm the settings and exit the menu.

 When enabling the Self-Timer, pressing the shutter or the down arrow button can disable the Self-Timer and return to the shooting screen while keeping the Self-Timer setting.

 When enabling the Smile Detection setting, pressing the shutter button or  button can disable the Self-Timer without keeping the Self-Timer-Smile setting.

## Flash Mode

The flash provides supplemental light for a scene. The flash is usually used when shooting against the light to highlight the subject; it is also suitable for metering and shooting in darker scenes to improve the picture exposure.



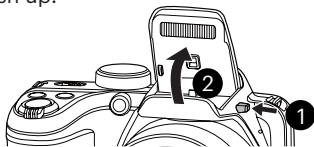

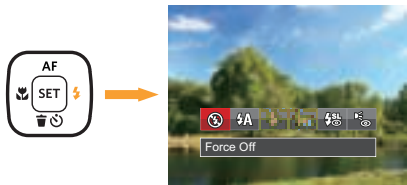

1. Press the flash button  to pop the flash up.



2. Press the right arrow button () to enter the Flash Settings Menu.



3. Press the left/right arrow buttons to select the following 6 modes:

-  Force Off  
Flash is turned off.
  -  Flash Auto  
Camera flash goes off automatically based on existing light conditions.
  -  Force Flash  
The flash will engage with each shot even if there is enough available light to take the photo without flash.
  -  Slow Sync.  
This allows you to take pictures of people at night that clearly show both your subjects and the night time backdrop. The use of a tripod is recommended when shooting with this setting.
  -  Slow Sync. + Red-Eye  
Use this mode for slow synchro shots with red-eye reduction.
  -  Red-Eye Reduction  
The camera emits a brief pre-flash before the picture is taken to reduce red-eye effects.
4. Press the **SET** button to confirm the settings and exit.

## White Balance Setting









The white balance function allows adjustment of the color temperature for different light sources (This can be adjustable in **PSAM** Modes).

Follow the steps below to set the white balance of the camera:

1. Press the **SET** button to enter the White Balance Menu.



2. Press the left/right arrow buttons to select from the following 8 modes:

-  AWB
  -  Daylight
  -  Cloudy
  -  Fluorescent
  -  Fluorescent CWF
  -  Incandescent
  -  Manual WB (Fully press the shutter button to detect the white balance value)
  -  Color Temp. (1900K-10000K)  
Press the direction buttons up / down to "Adjust the K value";  
Press the direction button Left to exit the K value.
3. Press the **SET** button to confirm the settings and exit the menu.



## Continuous Shot

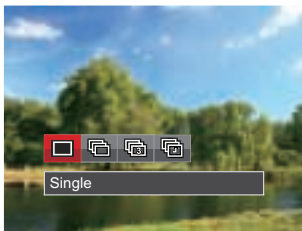

Follow the steps below to configure the Continuous Shot settings:

1. Press the  to enter the Continuous Shot menu.



2. Press the left/right arrow buttons to select the following 4 modes:

-  Single
-  Continuous Shot

-  3 Shots
-  Time-Lapse  
Take pictures based on the preset interval (30sec/ 1min/ 5min/ 10min).

3. Press the  button to confirm the settings and exit the menu.
4. Press the shutter button to start shooting.

-  The flash is disabled in this mode in order to achieve quick succession of shots.

## EV Setting

The EV Function Menu of the camera includes functions, such as EV Adjustment, ISO, Shutter Adjustment, Aperture Adjustment, etc. Using the appropriate Function Settings can improve your pictures.

To select the best setting follow these steps:

1. Press the  button to display the Settings screen.
2. Press the left/right arrow buttons to select the Setting options.

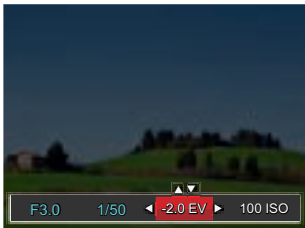

3. Press the up/down arrow buttons to adjust the option values.
4. Press the  button to complete the setting and enter shooting mode.

## Exposure Compensation

Set up Exposure Compensation to adjust the picture brightness. If there is very high contrast between the photographed object and the background, the brightness of the picture can be adjusted as necessary. (This can be adjusted in **PS A**  Mode)

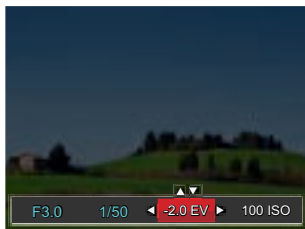

The adjustable range of exposure value is from EV -2.0 to EV+2.0.

## ISO

The ISO function allows you to set the sensitivity of the camera's light sensor based on the brightness of the scene. To improve the camera's sensor performance in darker environments, a higher ISO value is required. A lower ISO value is needed when shooting in brighter conditions.

Pictures taken at higher ISO settings will generally have more noise than those taken at lower ISO settings. (This can be adjusted in **PSAM** + Mode)

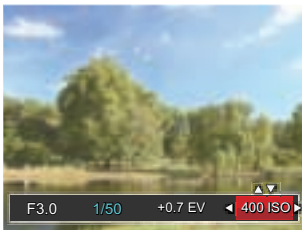

The camera's ISO settings include: Auto, 80 100, 200, 400, 800, 1600 and 3200.

## Shutter Adjustment

For shutter speed, the camera may automatically set the aperture value corresponding to the manually set shutter speed to obtain the most suitable exposure value. The movement of an object may be shown by adjusting the shutter speed. A higher shutter value can help you more clearly capture fast moving objects, while a lower shutter value can better show the movement of objects. (This can be adjusted in **SM** Mode)



## Aperture Adjustment

You can adjust the aperture size value in this setting. Selecting a large aperture opening will emphasize the point of focus and show a blurry background and foreground. A small aperture opening will keep both the background and main object in clear focus. (This can be adjusted in **AM** Mode)



## Using Quick Recording

In Photo Shooting mode, press the recording shortcut button (  ) to begin recording video.



Once you are finished, press the recording short cut button or the shutter button to stop and store the video. The camera will automatically return to the current shooting mode set .

## "i" Button Function Menu



Mode: **PSAM** 



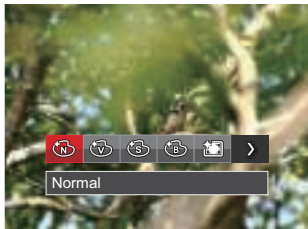

The Image Color Setting allows you to select different effects.

1. Press the  button to select the Image Color Setting Menu.
2. Press the left/right arrow buttons to select the image color setting options.







There are 7 image color options in photo shooting mode **PSAM** :

-  Normal
-  Vivid

-  Sepia
-  Black and White
-  Vignetting
-  Salon
-  Dreamy

There are 4 image color options in movie mode  :



-  Normal
-  Vivid
-  Sepia
-  Black and White



# PLAYBACK

## Viewing Photos and Videos

To view photos and videos on the LCD:

1. After pressing the  button, the last photo or video clip taken will be displayed on the LCD.
2. Use the left/right navigation buttons to scroll through the photos or video clips stored on the internal memory or on the Memory Card.
3. To play a selected video clip, press the  button to enter the movie playback mode. An operation guide appears on the screen when playing back a video. Press the appropriate buttons to enable the corresponding functions.

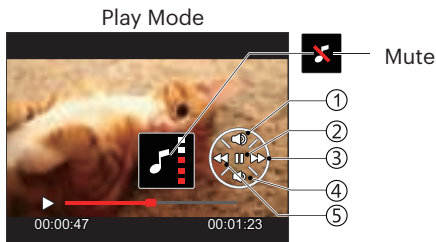

1	Increase Volume
2	Pause
3	Fast Forward
4	Decrease Volume
5	Rewind

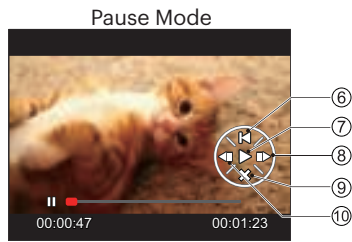

6	Return to the Beginning of the Video
7	Play
8	Play Video Forward
9	Cancel Playback
10	Play Video Backward

## Thumbnail View

When in Playback Mode, rotate the Zoom lever counter clockwise to the **W** position to display thumbnail images of the photos and videos on the screen.

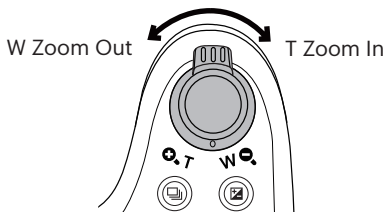

1. Slide the Zoom Lever to switch between 3 x 3 and 4 x 4 thumbnails.

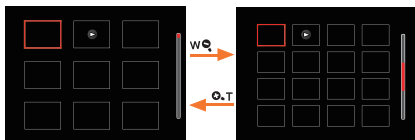



2. Press the arrow buttons to select a picture or video clip to view and press the **SET** button to restore it to the original size.

If the **▶** indicator appears on the LCD, then a movie file is currently being displayed.

## Using Zoom Playback (for still pictures only)

When playing back photos, you can also use the Zoom Slider to zoom in on the photos 2 to 8 times their original magnification.

1. Press the  button to switch to Playback Mode.
2. Press the left/right arrow buttons to select the picture on which to use the zoom feature.
3. Rotate the Zoom Lever clockwise to (  ) to zoom in.
4. The bottom right corner of the screen will display the number of times the image is magnified and area of the photo shown.

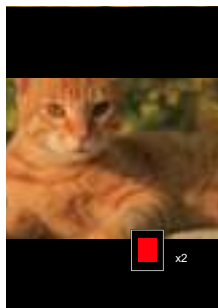



5. Press the arrow buttons to navigate and select a portion of the photo to be zoomed in on.
6. Press the  button to return the image to its original scale.



## Deleting Photos and Videos

In Playback Mode, press the down arrow button   to delete your photos and videos.

To delete photos or videos:

1. Press the  button to switch to Playback Mode.
2. Press the left/right arrow buttons to select the photos and videos to be deleted.
3. Press the down arrow button   and the deletion screen is displayed.



4. Press the up/down arrow buttons to select [Delete One] or [Exit] and press the  button to confirm.





Deleted photos/video clips cannot be recovered.



Please refer to page 74 for instructions on deleting more than one image at a time.



## Slideshow

You can use this setting to view all of the stored pictures as a slideshow.

1. Press the  button to enter Playback screen.
2. Press the  button to enter the slide option (except for video files).
3. Press the left/right arrow buttons to select slideshow playing or [Cancel] to return to the Playback screen.





4. Press the  button to confirm the setting.

-  Pictures rotate automatically during a slide show.
-  Slide playing function supports movie playing.

# USING THE MENUS

## Photo Setup Menu

Mode:  **PSAM** +  **SCN**

1. In Photo Shooting Mode, press the  button to enter the Photo Shooting Menu.
2. Press the up/down arrow buttons to select the Photo Shooting Menu to be set.
3. Press the left/right arrow buttons to select the Photo Shooting Menu to be set and press the  button to confirm.



Refer to the following pages for more details about each setting.

### **Expo Metering (Exposure Metering)**

Use this setting to select the "target" size of the camera's field of view to be metered.



There are 3 options:

- **AiAE (Artificial Intelligence AE):** Automatically selects the central and peripheral metering to calculate the reasonable value of metering by weighting.
- **Spot:** Metering targets a small area in the center of the camera's field of view.
- **Center:** Metering targets a slightly larger area in the center of the camera's field of view.

## Image Size

The size setting refers to the image resolution in pixels. A higher image resolution allows you to print that image in larger sizes without degrading the photo image quality.



- ① The bigger the number of recorded pixels is, the better the image quality becomes. As the number of recorded pixels lessen, you will be able to record and store more images on a memory card.

## OIS (Optical Image Stabilization)

This mode can help reduce photo blur caused by unintentional shaking or low light.



- ① Use the Image Stabilization Mode in darker environments.
- ① Shooting in a windy or unstable environment (such as a moving vehicle) may cause blurry images.
- ① You may not need OIS when using a tripod.

## Continuous AF

Use the Continuous AF setting to be able to continuously focus automatically when taking pictures.



There are 2 options:

- Off
- On

## HDR (High Dynamic Range)

With the HDR function, pictures that are overexposed may be corrected to optimize the highlights and lowlights captured to more accurately represent the actual scene. (Use of tripod is recommended)



There are 2 options:

- Off
- On



In the scenario with high light contrast (too dark or too light), this function can be used to shoot better photos.





## Face Beautifier

Select the effect for Face Beautifier Mode.



Face Beautifier Mode has 3 effects:







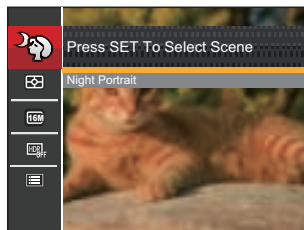

-  Effect 1: Skin Soften
-  Effect 2: Skin Soften + Eye Brightening
-  Effect 3: Skin Soften + Eye Brightening + Eye Enlargement

## Scene

Select the Scene Mode under the SCN Mode.





• Shooting Menu in the Shooting Mode (O: Available X: Unavailable)





Options	Shooting Modes					
		<b>P</b>	<b>S</b>	<b>A</b>	<b>M</b>	
	O	O	O	O	O	O
	O	O	O	O	O	O
	O	O	O	O	O	O
	O	O	O	O	O	O
	O	O	O	O	O	X
	X	X	X	X	X	O

## Photo Shooting Setting Menu

Mode: **PSAM** + **SCN**

1. Press the  button in Photo Shooting Mode and press the up/down arrow buttons to select .



2. Press the  button to enter the menu.
3. Press the up/down arrow buttons to select  and press the  button or right arrow button to enter the menu.
4. Press the up/down arrow buttons to pick the item to be selected and press the  button or right arrow button to enter the menu.
5. Press the up/down arrow buttons to select an option and press the  button to confirm.

### Quality

The quality setting can be used to adjust the image compression ratio.



There are three options for picture quality:

- Best (16M Average File Size: 4.0MB)
- Fine (16M Average File Size: 2.6MB)
- Normal (16M Average File Size: 2.2MB)

## AF-Assist Beam

In a darker environment, the AF assist beam setting can be turned on for better focus.



## Digital Zoom

This setting is for adjusting digital zoom. If this function is disabled, only optical zoom can be used.



## Date Imprint

Include a Date/Time stamp on the photo image.



- Off
- Date
- Date / Time

## Quick Review

This option allows quick review of the photos immediately after they are taken. Each photo is displayed on the LCD screen based on the selected time.



There are 4 options:

- Off
- 1 sec
- 2 sec
- 3 sec

## Custom Settings

Custom settings stores the current photo shooting mode and its parameters. The stored mode and parameters are directly invoked in Custom Settings Mode.



There are 2 options:

- No
- Yes

## Face Detection

For detecting and focusing on faces to make most faces as clear as possible in Photo Mode.





There are 2 options:

- Off
- On

## Movie Menu

Mode: 

1. Turn the Mode dial, select the  mode and press the  button to enter the Movie Menu.



2. Press the up/down arrow buttons to select the Movie Menu to be set.
3. Press the left/right arrow buttons to select the Movie Menu to be set and press the  button to confirm.

## Expo Metering (Exposure Metering)

Use this setting to select the "target" size of the camera's field of view to be metered.

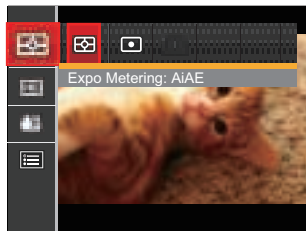

There are 3 options:

- AiAE (Artificial Intelligence AE): Automatically selects the central and peripheral metering to calculate the reasonable value of metering by weighting.
- Spot: Metering targets a small area in the center of the camera's field of view.
- Center: Metering targets a slightly larger area in the center of the camera's field of view.

## Video Quality

Set the image resolution used during video recording.

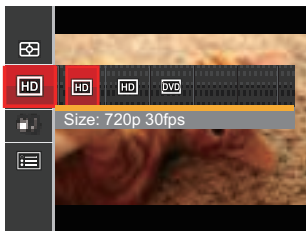

The speed requirements for reading and writing high resolution image pixel images to a memory card are as follows:

No.	Image Pixels	Frames	Recommended Card Class	Approximate Recording Time (4GB)
1	1280 x 720 *	30	Class 6	58 Minutes
2	1280 x 720	15	Class 4	61 Minutes
3	640 x 480	30	Class 4	69 Minutes

 \* The longest recording time is 29 minutes at one time.



When recording in higher pixel resolutions for extended periods of time, this can cause the camera to generate heat. This is not a camera malfunction.

## OIS (Optical Image Stabilization)

This mode can help reduce photo blur caused by unintentional shaking, low light or slow shutter speed.

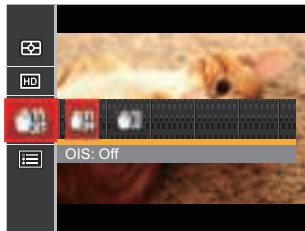

Use the Image Stabilization Mode in darker environments.



Shooting in a windy or unstable environment (such as a moving vehicle) may cause blurry images.









You may not need OIS when using a tripod.





## Movie Setting Menu

Mode: 

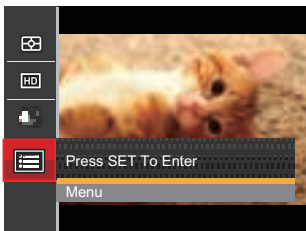
1. Turn the Mode dial and select  to enter the video recording screen.
2. Press the  button, press the up/down arrow buttons to select , and press the  button to enter the menu.
4. Select the items to be set and press the  button or the right arrow button to enter the menu.
5. Press the up/down arrow buttons to select an option and press the  button to confirm.



3. Press the up/down arrow buttons to select , and press the  button or right arrow button to enter the menu.

## Digital Zoom

This setting is for adjusting Digital Zoom. If this function is disabled, only Optical Zoom can be used.





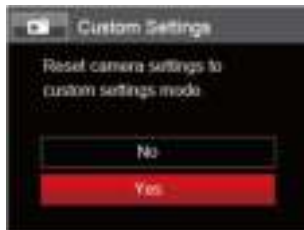

## Custom Settings

Custom settings stores the current movie shooting mode and its parameters. The stored mode and parameters are automatically used in Custom Settings Mode.



## Playback Menu

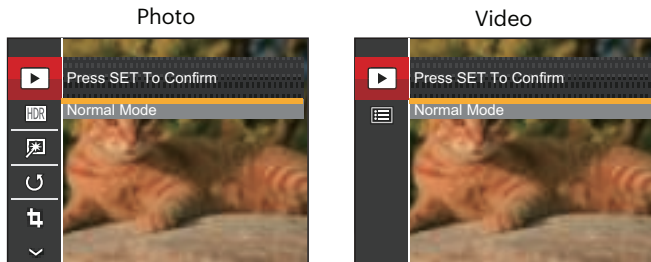

Mode: 

1. Press the  button to display the playback screen and press  button to enter the menu.
2. Press the up/down arrow buttons to select the desired playback and press the  button to enter.
3. Press the left/right arrow buttons to select an option and press the  button to confirm.



Refer to the following pages for more details about each setting.

## Playback

1. Press the  button, select the  settings and press the  button to display the settings screen.
2. Press the left/right arrow buttons to select from the following 2 functions:



Normal Mode: Display all images.



Date Mode: Arranged by date.

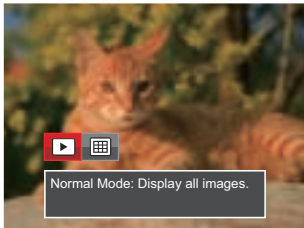



3. Press the  button to confirm the setting.



The date folder is displayed in date order based on camera's date/time settings.

## HDR (High Dynamic Range)

With the HDR function, pictures that are overexposed may be corrected to optimize the highlights and low lights captured to more accurately represent the actual scene.

1. In Playback Mode, press the left /right arrow buttons to select the photos to be edited.
2. Press the  button, select the  settings, and press the  button to display the settings screen.
3. Press the left/right arrow buttons to select whether HDR is used.

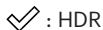



: HDR







: Cancel

4. After using the HDR function, the image will be saved as a new file and the original file is still stored in the memory.

## Touch-Up

1. In Playback Mode, press the left /right arrow buttons to select the photos to be edited.
2. Press the  button, select the  settings, and press the  button to display the settings screen.
3. Press the left/right arrow buttons to select Touch-up options or [Cancel] to return to the Playback screen.



-  : Red-Eye Reduction
-  : Skin Soften
-  : Eye Brightening
-  : Eye Enlargement
-  : Cancel



4. Press the  button to confirm the setting.





The Touch-Up referred to is the individual use of three effects. Beauty Mode allows you to select one, two or all three of the effects combined.

## Rotate

You can use this setting to change the orientation of the picture.

1. In Playback Mode, press the left /right arrow buttons to select the photos to be edited.
2. Press the  button, select the  settings, and press the  button to display the settings screen.
3. Press the left/right arrow buttons to select the rotation direction or [Cancel] to return to the Playback Screen.



 : Turn Right  : Turn Left

 : Cancel

4. Press the  button to confirm the setting.





Videos and panoramic pictures cannot be rotated.



The rotated picture file will replace the original photo.

## Resize

This setting allows you to resize a picture to a particular resolution and saves it as a new picture.

1. In Playback Mode, press the left/right arrow buttons to select the photos to be edited.
2. Press the  button, select the  settings and press the  button to display the settings screen.
3. Press the left/right arrow buttons to select [1024] or [640] or select [Cancel] to return to the Playback Screen.



**1024** : Resize to 1024 x 768

**640** : Resize to 640 x 480

 : Cancel

4. Press the  button to confirm the setting.

## "i" Button Playback Function

This setting allows you to change the picture color effect. The file is saved as a new photo and stored in the camera's memory or SD card together with the original photo.

1. In Playback Mode, press the left/right arrow buttons to select the photos to be edited.
2. Press the **(i)** button to select the image color setting menu.
3. Press the left/right arrow buttons to select the corresponding menu or [Cancel] to return to the playback screen.

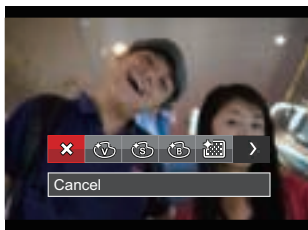

4. Press the **(SET)** button to confirm the setting.





There are 8 options:

- Cancel
- Vivid
- Sepia
- Black and White
- Grainy
- Vignette
- Salon
- Dreamy







## Playback Setting Menu

Mode: 

1. Press the  button to show the playback screen, press the  button, and press the up/down arrow buttons to select .
2. Press the  button to enter the menu.



3. Press the up/down arrow buttons to select , and press the  button or right arrow button to enter the menu.
4. Press the up/down arrow buttons to select the item to be set and press the  button or right arrow button to enter the menu.

5. Press the up/down arrow buttons to select an option and press the  button to confirm.

Refer to the following pages for more details about each setting.

## Protect

To prevent any pictures or videos from being accidentally erased, use this setting to lock one or all of the files.



To lock or unlock the photo and video files:

1. Press the up/down arrow buttons to select [Protect] and press the **SET** button or right arrow button to enter the sub-menu.
2. Press the up/down arrow buttons to select the sub-menu and press the **SET** button or right arrow button to show the settings screen.

There are 4 sub menus available:

- One  
Lock the selected photo or video if they are unprotected; unlock the selected photo or video if they are protected.
  - Date Folder  
Protect all photos in the Date Folder.
  - All  
Lock all photos or videos.
  - Reset  
Cancel all locked photos or videos.
3. Press the up/down arrow buttons to select an option and press the **SET** button to confirm.

## Delete

You can delete one or all photo/video files.







To delete photo or video files:

1. Press the up/down arrow buttons to select [Delete] and press the **SET** button or right arrow button to enter the submenu.
2. Press the up/down arrow buttons to select the submenu and press the **SET** button or right arrow button to show the settings screen.

There are 3 sub menus available:

- One  
Delete one photo or video.
  - Date Folder  
Delete all photos in the Date Folder.
  - All  
Delete all photos or videos.
3. Press the up/down arrow buttons to select an option and press the **SET** button to confirm.

-  The “” indicator means a file is protected. File protection must be removed before a file can be deleted.
-  Deleting files will cause DPOF settings to be reset.
-  When a single photo is protected in the date folder, the protected photo will be kept and other photos will be deleted.
-  Deleted files will be permanently deleted and will not be able to be recovered or restored.

## DPOF (Digital Print Order Format)

The DPOF feature allows you to compile and select a group of pictures that you would like to print and will save your selection on the memory card so that you can use the memory card to print without having to individually specify the photos you want to print.



A compatible printer that supports DPOF is needed for DPOF photo printing.

## Trim

The Trim setting allows you to crop photos and save them as new pictures.

1. Press the up/down arrow buttons to select [Trim] and press the **SET** button or right arrow button to enter the menu.
2. Select [Yes] to confirm trim. Select a section of the photo to be trimmed using the Zoom Lever and arrow buttons to trim a photo.







3. Press the **SET** button and the [Save Change?] prompt appears. Select [✓] to change and save the picture. Select [✗] to cancel changes and return to the trim prompt screen.





The image cannot be clipped/trimmed again once it has been clipped to 640 X 480.

## Setup Menu

Mode :  **PSAM**  **SCN**  

1. Press the  button in any mode and press the up/down buttons to select .
2. Press the  button to enter the menu.
3. Press the up/down arrow buttons to select , and press the  button or right arrow button to enter the menu.



4. Press the up/down arrow buttons to select the item to be set and press the  button or right arrow button to enter the menu.
5. Press the arrow buttons to select an option and press the  button to confirm.

Refer to the following pages for more details about each setting.

### Sound Settings

To change this setting:

1. Select [Sound Settings] in the basic settings menu. Press the  button or right arrow button to enter the menu.
2. Press the left/right arrow buttons to select an option.



3. Press the  button to confirm.

## Power Saver

This setting allows you to save power and get the maximum possible running time for your camera's batteries. Follow the steps below to turn the LCD and camera off automatically after a consecutive period of inactivity.

1. Select [Power Saver] in the Basic Settings Menu. Press the **SET** button or right arrow button to enter the menu.
2. Press the up/down arrow buttons to select an option.



3. Press the **SET** button to confirm.



Power Saver	LCD Power Off Time	Turn Off Time
Auto	3 Min	5 Min
Normal	1 Min	3 Min
Best	30 S	1 Min

## Language

Refer to the “Resetting your language” section on page 18.

## World Time

The Zone Setting is a useful function for your overseas trips. This feature enables you to display the local time on the LCD while you are abroad.

1. Select [World Time] in the Basic Settings Menu. The world time screen appears.
2. Press the up/down arrow buttons to select the departure place (  ) and destination (  ) fields.
3. Press the left/right arrow buttons to select a city located in the same time zone as that of the field. Press the **SET** button to confirm settings.



## Date/Time

Refer to the “Resetting Date/Time” section on page 19.

## LCD Brightness

Use this setting to adjust the brightness of your LCD.

1. Select [LCD Brightness] in the basic settings menu. Press the **SET** button or right arrow button to enter the menu.
2. Press the up/down arrow buttons to select an option.

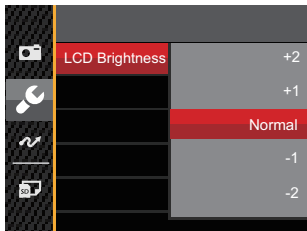

3. Press the **SET** button to confirm.

## Battery Type

Please choose the right type of battery before using.

1. Select [BATTERY TYPE] in the basic settings menu. Press the **SET** button or right arrow button to enter the menu.
2. Press the up/down arrow buttons to select an option.

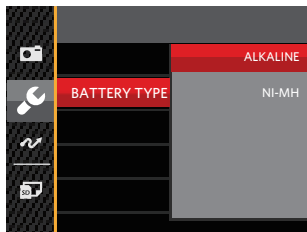







3. Press the **SET** button to confirm.

## File Settings

### Format

Please Note: formatting enables you to delete all contents on a memory card and camera's built-in memory, including protected photo and movie files.

To use this setting:

1. Press the  button, press the up/down arrow buttons to select  and press the  button to enter the menu.
2. Press the up/down arrow buttons to select  and press the  button or right arrow button to enter the menu.
3. Press the up/down arrow buttons to select [Format] and press the  button or right arrow button to enter the menu.
4. Press the up/down arrow buttons to select [Yes] or [No] and press the  button to confirm.
5. If you select [Yes] the camera will format its memory.









-  If there is no memory card in the camera, the built-in memory will be formatted; if there is a memory card installed, only the memory card will be formatted.



## Copy to Card

Use this setting to copy the files stored in the internal memory to an memory card.







1. Press the  button, press the up/down arrow buttons to select  and press the  button to enter the menu.
2. Press the up/down arrow buttons to select  and press the  button or right arrow button to enter the menu.
3. Press the up/down arrow buttons to select [Copy to Card] and press the  button or right arrow button to enter the menu.
4. Press the up/down arrow buttons to select [Yes] or [No] and press the  button to confirm.



If there is no card available in the camera, this function will not be displayed.

## File Numbering







After you take a picture or video clip, the camera will automatically save it with a sequential number. You can use this feature and setting to reset the file numbering to 0001.

1. Press the  button, press the up/down arrow buttons to select  and press the  button to enter the menu.
2. Press the up/down arrow buttons to select  and press the  button or right arrow button to enter the menu.
3. Press the up/down arrow buttons to select [File Numbering] and press the  button or right arrow button to enter the menu.
4. Press the up/down arrow buttons to select [Yes] or [No] and press the  button to confirm.



## Reset







Use this setting to restore the camera to its original default settings.

1. Press the  button, press the up/down arrow buttons to select  and press the  button to enter the menu.
2. Press the up/down arrow buttons to select  and press the  button or right arrow button to enter the menu.
3. Press the up/down arrow buttons to select [Reset] and press the  button or right arrow button to enter the menu.
4. Press the up/down arrow buttons to select [Yes] or [No] and press the  button to confirm.



## Firmware (FW) Version

Use this setting to view the current firmware version installed on your camera.

1. Press the  button, press the up/down arrow buttons to select  and press the  button to enter the menu.
2. Press the up/down arrow buttons to select  and press the  button or right arrow button to enter the menu.
3. Press the up/down arrow buttons to select [FW Version] and press the  button or right arrow button to enter the menu.
4. When there is a new firmware version on a memory card, select [Yes] to update.









# CONNECTIONS

## Connecting to a Computer

You can use a micro USB cable (which should be purchased separately) to connect the camera and copy (transmit) photos to a computer, printer or other device.

### Setting the USB Mode

The camera's USB port can be used to connect to either a computer or a printer. The following steps will allow you to ensure that the camera is correctly configured to connect with a computer.

1. Press the  button, press the up/down arrow buttons to select  and press the  button to enter the menu.
2. Press the up/down arrow buttons to select  and press the  button or right arrow button to enter the menu.
3. Press the up/down arrow buttons to select [USB] and press the  button or right arrow button to enter the menu.

4. Press the up/down arrow buttons to select [PC] and press the  button to confirm.



## Transferring Files to Your Computer

The computer will automatically detect the camera as a removable drive. Double-click the “My Computer” icon on the desktop to locate the removable drive and to copy folders and files in the drive to a directory on your computer as you would copy any typical folder or file.





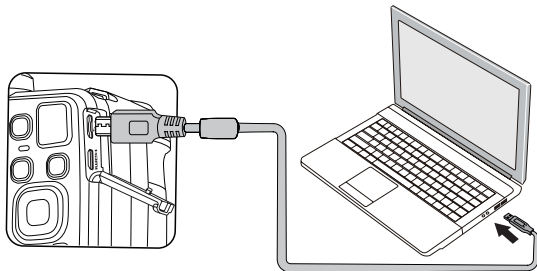

Follow the steps below to connect the camera to a computer:

1. Make sure the computer is turned on.
2. Connect one end of the micro USB cable to the USB/AV OUT port on your camera.
3. Connect the other end of the micro USB cable to an available USB port on your computer.
4. After the transmission is complete, disconnect the micro USB cable according to your computer manufacturer’s instructions specifying how to safely remove USB devices.



## Video System

You can use the AV cable (which should be purchased separately) to connect the camera and the television for setting up the video output. Connect one end of the AV cable to AV port of the camera and connect the other end to AV-OUT port of the television. To adjust the format of the video output system according to your requirements:

1. Press the  button, press the up/down arrow buttons to select  and press the  button to enter the menu.
2. Press the up/down arrow buttons to select  and press the  button or right arrow button to enter the menu.
3. Press the up/down arrow buttons to select [TV-System] and press the  button or right arrow button to enter the menu.
4. Press the up/down arrow buttons to select [NTSC] or [PAL] and press the  button to confirm.









 The video output system changes based on the selected language.

NTSC: English, Chinese (Traditional), Japanese, French, Korean, Russian, Vietnamese, Greek, Hungarian

PAL: German, Spanish, Italian, Chinese (Simplified), Portuguese, Swedish, Danish, Finnish, Indonesia, Norwegian, Dutch, Turkish, Polish, Thai, Croatian, Czech, Arabic, Hindi

## Set Eye-Fi Card Connection Mode

This camera supports wireless connection for Eye-Fi cards. Enable the Eye-Fi connection by following the steps below:

1. Press the  button, press the up/down arrow buttons to select  and press the  button to enter the menu.
2. Press the up/down arrow button to select  and press the  button or right arrow button to enter the menu.
3. Press the up/down arrow buttons to select [Eye-Fi] and press the  button or right arrow button to enter the menu.
4. Press the up/down arrow buttons to select [On] or [Off] and press the  button to confirm.

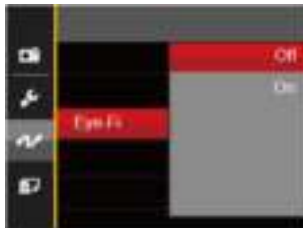

If the Eye-Fi card is not available in the camera, this feature is not displayed.

## Supported HDMI Connections

HDMI (High Definition Multimedia Interface), is a fully digital audio/video transmission interface, through which uncompressed audio and video signals are transmitted.

Direct transmission of digital video signals to your TV reduces conversion loss and improves image quality.

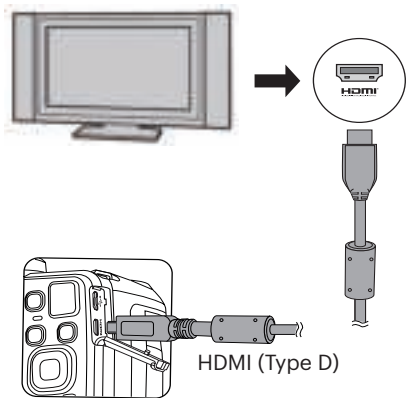

### Connecting HDMI-Ready TV

1. Use a cable with a high resolution output terminal (which should be purchased separately) to connect the camera to the television which meets HDMI standards.
  2. The camera will be automatically detected by the TV.
  3. After connecting via HDMI, the camera will enter Playback Mode.
- ⓘ Make sure the camera and the TV are both turned on before connecting.
  - ⓘ Refer to your TV instruction manual for information on what resolution it will support. Resolution and output formats that are not supported will be grayed out on the camera's LCD.







## Connecting to a PICTBRIDGE™ Compatible Printer

PICTBRIDGE™ technology allows printing of photos saved on the memory card by a PICTBRIDGE™ compatible printer.



To find out if a printer is PICTBRIDGE™ compatible, simply look for the PICTBRIDGE™ logo on the packaging or check the owner's manual for specifications. With the PICTBRIDGE™ function on your camera, you can print captured photos directly to a PICTBRIDGE™ compatible printer using the micro USB cable, without the need for a PC.

### Setting the USB Mode

The camera's USB port can be set to connect with either a PC or a Printer, the following steps will ensure that the camera is correctly configured to connect with a printer.

1. Press the  button, press the up/down arrow buttons to select  and press the  button to enter the menu.
2. Press the up/down arrow buttons to select  and press the  button or right arrow button to enter the menu.
3. Press the up/down arrow buttons to select [USB] and press the  button or right arrow button to enter the menu.
4. Press the up/down arrow buttons to select [Printer] and press the  button to confirm.



-  After the camera is reset, it will switch to PC Mode automatically from USB Mode.
-  See "Using the PICTBRIDGE™ Menu" section on page 89.



## Connecting to your Printer

1. Make sure the printer is turned on.
2. Connect one end of the micro USB cable to the USB port on your camera.
3. Connect the other end of the micro USB cable to the USB port on the printer.

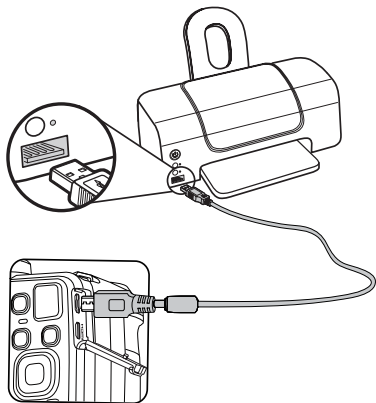

If the camera is not connected to a PICTBRIDGE™ compatible printer, the following error message will appear on the LCD.

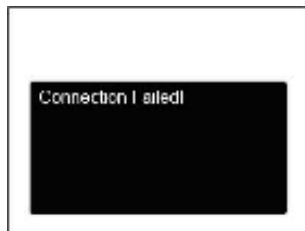

The error message above will also appear if the USB mode is set incorrectly, in which case you should disconnect the micro USB cable, check the USB mode settings, ensure that the printer is turned on, then try connecting the micro USB cable again.

## Using the PICTBRIDGE™ Menu

After setting the USB Mode to Printer, the PICTBRIDGE™ Menu will appear.



Press the up/down arrow buttons to select a menu item and press the **SET** button or right arrow button to enter the item.

Refer to the following sections for more detailed information on each setting.

### **Print (with Date)**

If you have set the date and time on your camera, the date and time will be recorded and saved with each photo you take.

1. In the PICTBRIDGE™ Menu, select [Print (with Date)] and the screen as shown below appears.



2. Press the left/right arrow buttons to select a photo to be printed.

3. Press the up/down arrow buttons to select the number of copies for the currently displayed photo.
4. Press the **SET** button and the following screen will appear.



5. Select [Yes] and press the **SET** button to confirm; select [Cancel] to cancel printing.

### **Print (without Date)**

Use this setting to print the photos without dates on them.

1. In the PICTBRIDGE™ Menu, select [Print (without Date)] and the screen as shown below appears.



2. Press the left/right arrow buttons to select a photo to be printed.
3. Press the up/down arrow buttons to select the number of copies for the currently displayed photo.
4. Press the **SET** button and the following screen will appear.



5. Select [Yes] and press the **SET** button to confirm; select [Cancel] to cancel printing.

## Print Index

You can print all photos in the camera via this function.

1. In the PICTBRIDGE™ Menu, select [Print Index] and the screen as shown below appears.



2. Select [Yes] and press the **SET** button to confirm; select [Cancel] to cancel printing.

## Print DPOF Images

To use DPOF printing, you must select your photos for printing using the DPOF settings first. See the “DPOF” section on page 75.

1. In the PICTBRIDGE™ Menu, select [Print DPOF Images] and the screen as shown below will appear.



2. Select [Yes] and press the **SET** button to confirm; select [Cancel] to cancel printing.

## Exit

Select [Exit] to exit the PICTBRIDGE™ Menu. At this time, the message [Remove USB Cable!] will appear on the screen.



Disconnect the micro USB cable from the camera and printer.

# APPENDICES

## Specifications



Design and specifications are subject to change without notice.

Image Sensor	Type	1/2.3"CCD
	Effective Pixels	16.15 Megapixels
	Total Pixels	16.44 Megapixels
Lens	Focal Length	4.3mm (Wide) — 172mm (Tele)
	35mm Film Equivalent	24mm (Wide) — 960mm (Tele)
	F Number	F3.0 (Wide) — F6.8 (Tele)
	Lens Construction	11 groups 15 elements
	Optical Zoom	40x
	Focusing Range	Normal: (Wide) 50cm ~ $\infty$ , (Tele) 200cm ~ $\infty$ ; Macro: 1.6cm ~ $\infty$ (Wide Only)
Autofocus System		TTL Autofocus
Anti-Handshake		Optical Image Stabilization (OIS)
Digital Zoom		4x Digital Zoom (Combined Zoom: 160x)

Number of Recording Pixels	Still Image	(4:3) 16MP: 4608 × 3456 10MP: 3648 × 2736 5MP: 2592 × 1944 3MP: 2048 × 1536 0.3MP: 640 × 480	(3:2) 14MP: 4608 × 3072	(16:9) 12MP: 4608 × 2592 2MP: 1920 × 1080
	Movie	1280 × 720 (30fps), 1280 × 720 (15fps), 640 × 480 (30fps)		
Image Compression		Best, Fine, Normal		
DCF, DPOF (Ver1.1) Support		Yes		
File Format	Still Image	Exif 2.3 (JPEG)		
	Movie	MOV [Image: H.264; Audio: Linear PCM (Monaural)]		
Shooting Modes		Auto Mode, Program AE, Shutter Priority, Aperture Priority, Manual Mode, Face Beautifier, Panorama Mode, Scene Mode, Movie Mode, Custom Settings		
Scene Mode		Pet Mode, Sunset, Fireworks, Sport, Night Portrait, Landscape, Portrait, Snow, Children, Party, Night Landscape, Auto Scene		
Detection Features		Face, Smile, Blink, Cat, Dog		
Photo Touch-up		Red-Eye Reduction, Skin Soften, Eye Brightening, Eye Enlargement		

HDR	Yes
Video Panorama	Up to 180° (Horizontal)
LCD Display	3.0 inch (460k Pixels)
ISO Sensitivity	Auto, ISO80/100/200/400/800/1600/3200(4M)
AF Method	Single AF, Multi-AF (TTL 9-point), Object Tracking, Face-Detection
Exposure Metering Method	Artificial Intelligence AE (AiAE), Center-Weighted Average, Spot (Fixed to Center of Frame), Face AE
Exposure Control Method	Program AE (AE-Lock Available), Shutter Prior AE, Aperture Prior AE
Exposure Compensation	±2 EV in 1/3 Step Increments
Shutter Speed	1/2000 ~ 30 Seconds
Continuous Shooting	Yes
Playback Modes	Single, Index (9/16 Thumbnails), Slide Show, Date, Zoom (Approx. ×2 ~ ×8)
White Balance Control	AWB, Daylight, Cloudy, Fluorescent, Fluorescent CWF, Incandescent, Manual WB, Color Temp. (1900K ~ 10000K)



Flash	Flash Method	Pop-Up (Manual)
	Flash Modes	Force Off, Flash Auto, Force Flash, Slow Sync., Slow Sync. + Red-Eye, Red-Eye Reduction
Recording Media		Internal Memory: Approx. 8MB
		SD/SDHC Card (Up to 32GB Support) [MMC Card not supported ]
Multi-Language Support		27 Languages
Jacks		AV-OUT/USB 2.0 (Micro 5 pin USB), HDMI (Type D)
Eye-Fi Support		Yes
Power		AA Alkaline Battery (× 4), AA Ni-MH Battery (× 4) (Not Included)
Shooting Capability (Battery Performance)		Approx. 280 Shots with AA Alkaline Batteries (Based on CIPA Standards)
Operation Environment		Temperature: 0 ~ 40°C, Humidity: 0 ~ 90%
Dimensions (W × H × D)		Approx. 114.3 × 81.6 × 84.4 mm (Based on CIPA Standards)
Weight		Approx. 436 g (Body Only)

## Prompts and Warning Messages

Message	Description	Solution
Warning! Battery exhausted.	The camera batteries are depleted. It is a warning indicating that the camera is going to shut off.	Replace with new batteries. The camera will shut down in 2 seconds.
Lens obstruction, Re-start Camera.	The lens is jammed or some foreign object is preventing the lens from functioning properly.	Turn the camera off and restart it to reset the lens.
Suggest using tripod.	When continuous exposure mode (Sunset, Fireworks, Night Portrait, Night Landscape) is enabled, this prompt message is displayed when the photo shooting screen is displayed for the first time.	This message will disappear after 2 seconds
Built-in memory error!	An error has occurred in the built-in memory.	Try shutting down the camera and turning it on again. This message will disappear after 2 seconds.
Improper alignment. Please try again.	The offset is too big for panorama shooting.	Retry taking the panoramic picture. This message will disappear after 2 seconds.
Warning! Do not turn off your camera during update!	This message appears during the firmware update process.	This message disappears after the camera update and restart.

Message	Description	Solution
Remove USB Cable!	Indicates that you can disconnect the USB cable.	This message disappears after you disconnect the USB cable.
Connection Failed!	Failure to connect to your PC, printer, TV (with HDMI).	Remove USB cable and retry connection.
Write Protect!	The SD card is locked.	Remove SD card and switch the lever on the side of card to UNLOCK. This message will disappear after 2 seconds.
Card Full!	Indicates that the SD card is full.	Replace SD card with another that has available memory. This message will disappear after 2 seconds.
Memory Full!	Indicates that the camera memory is full.	It will disappear after 2 seconds.
Card Error!	During power-on, the SD card cannot be recognized or a read/write error occurs has occurred.	Format the SD card. <b>WARNING:</b> Formatting the SD card will erase all data on the card. Copy the data from the SD card to another storage, such as a computer. Otherwise, all data will be erased after the format. This message will disappear after 2 seconds.

Message	Description	Solution
Card is not formatted.	When an error occurs with the memory card, the message "Not Formatted" will appear.	Format the memory card. <b>WARNING:</b> Formatting the SD card will erase all data on the card. Copy the data from the memory card to another storage device, such as a computer. Otherwise, all data will be erased after the format. This message will disappear after 2 seconds.
Slow access	When a memory card lower than Class 4 is used to record a HD movie, the writing speed will be slower and recording will not continue.	Replace the memory card with a Class 4 or higher SD card. This message will disappear after 2 seconds.
Cannot write to SD card.	The photo shooting or video recording has been interrupted, so recording cannot continue.	Turn the camera off. Then unload and reload the SD card and turn on the camera to restart. Also check if SD card is full or in the locked position.
No Red-Eye Detected!	Red eyes have not been detected in the image.	This message will disappear after 2 seconds.
This image cannot be edited.	The file format does not support editing or the edited file cannot be edited again.	This message will disappear after 2 seconds.

Message	Description	Solution
Exceeded maximum folder number.	This indicates that the SD card exceeded the maximum number of folders (999). This could cause a long read time during the camera's power up.	Copy the data to your PC, and format the memory card using the camera.
Too many pictures for fast processing.	During the playback by date, the images exceed specifications so that it is not possible to play by date.	This message disappears after 2 seconds and the camera returns to normal playback mode.
Unable to recognize files.	The format of the file to be viewed is not supported or the file is corrupted so it cannot be properly read.	This message disappears only after the file is deleted.
No Picture!	When you press the play button, no image files exist in the camera or memory card.	This message disappears after 2 seconds and returns to the photo shooting screen.
Protected! Undeletable!	The file is protected. The message appears when you go into delete mode.	Remove SD card and switch the lever on the side of card to UNLOCK. Place card back into the camera and try again. This message will disappear after 2 seconds.

## Troubleshooting

Problem	Possible causes	Solution
Camera does not turn on	<ul style="list-style-type: none"> <li>■ The batteries have been depleted.</li> <li>■ The batteries are not inserted correctly.</li> </ul>	<ul style="list-style-type: none"> <li>■ Replace the batteries.</li> <li>■ Correctly reinstall the batteries.</li> </ul>
Camera turns off suddenly during operation	<ul style="list-style-type: none"> <li>■ The batteries have been depleted.</li> </ul>	<ul style="list-style-type: none"> <li>■ Replace the batteries.</li> </ul>
The picture is blurred	<ul style="list-style-type: none"> <li>■ Camera shakes while taking a picture.</li> </ul>	<ul style="list-style-type: none"> <li>■ Turn on OIS Feature.</li> <li>■ Please use tripod for high magnification (above 15X) Optical Zoom.</li> </ul>
Images and video files cannot be saved	<ul style="list-style-type: none"> <li>■ The memory card is full.</li> <li>■ The memory card is locked.</li> </ul>	<ul style="list-style-type: none"> <li>■ Use another memory card or delete unnecessary files.</li> <li>■ Unlock the memory card.</li> </ul>
Images will not print from the connected printer	<ul style="list-style-type: none"> <li>■ The camera is not connected to the printer correctly.</li> <li>■ The printer is not PICTBRIDGE™ compatible.</li> <li>■ The printer is out of paper or ink.</li> <li>■ The printer paper is jammed.</li> </ul>	<ul style="list-style-type: none"> <li>■ Check the connection between the camera and printer.</li> <li>■ Use a PICTBRIDGE™ compatible printer.</li> <li>■ Load paper into the printer or replace the ink cartridge in the printer.</li> <li>■ Remove the jammed paper.</li> </ul>

Problem	Possible Causes	Solution
Saving data to memory card is slow	<ul style="list-style-type: none"> <li>Using a memory card below Class 4 may result in slower recording times.</li> </ul>	<ul style="list-style-type: none"> <li>Use a memory card with write Class 4 or higher to improve performance.</li> </ul>
Cannot write to the memory card	<ul style="list-style-type: none"> <li>The memory card has been locked.</li> </ul>	<ul style="list-style-type: none"> <li>Release the write lock of the memory card or replace with another card.</li> </ul>
Too many movies to process	<ul style="list-style-type: none"> <li>The number of pictures or folders in the memory card exceed the specifications, so the playback of data folder can not be displayed.</li> </ul>	<ul style="list-style-type: none"> <li>Delete unwanted files.</li> </ul>
The flash  flashes on the LCD.	<ul style="list-style-type: none"> <li>Current shooting environment requires flash.</li> </ul>	<ul style="list-style-type: none"> <li>Turn on flash.</li> </ul>

© 2017 JK Imaging Ltd. All Rights Reserved.

The Kodak trademark, logo and trade dress are used under license from Eastman Kodak Company.

All other logos, products or company names that are referred to in this document are trade names, trademarks or registered trademarks of their holders. The holders are not affiliated with JK Imaging Ltd., our products or our website.

JK Imaging Ltd., 17239 So. Main Street, Gardena, CA 90248 USA

JK Imaging Europe, 71 Clarendon Road, Watford, WD17 1DS, UK

[kodakpixpro.com](http://kodakpixpro.com)

Made in Myanmar

